

## Price List

effective from April, 2022



## NABL

Accredited Laboratory  
As per ISO 17025:2017

**01.001** Burettes "RELIGLAS", with Straight Bore Glass Key with screw nut retaining provision Stopcock. Accuracy as per Class 'A' of ISO 385/ IS 1997 : 2008, with Calibration Certificate.

Cat. No.	Capacity (ml)	Sub. Div. (ml)	Tolerance ( $\pm$ ml)	Price / Piece Rs.
01.001.11	10	0.05	0.02	790.00
01.001.12	10	0.02	0.02	990.00
01.001.13	25	0.1	0.05	720.00
01.001.14	25	0.05	0.03	895.00
01.001.15	50	0.1	0.05	750.00
01.001.17	100	0.2	0.1	775.00

**N-002** Burettes "RELIGLAS", with Straight Bore Glass Key with screw nut retaining provision Stopcock. Accuracy as per Class 'A' of ISO 385/ IS 1997 : 2008, with NABL Certificate.



Cat. No.	Capacity (ml)	Sub. Div. (ml)	Tolerance ( $\pm$ ml)	Price / Piece Rs.
N-002.11	10	0.05	0.02	1470.00
N-002.12	10	0.02	0.02	1550.00
N-002.13	25	0.1	0.05	1415.00
N-002.14	25	0.05	0.03	1565.00
N-002.15	50	0.1	0.05	1400.00
N-002.17	100	0.2	0.1	1450.00

**01.003** Burettes "RELIGLAS", AMBER, with Straight Bore Glass Key with screw nut retaining provision Stopcock. Accuracy as per Class 'A' of ISO 385/ IS 1997 : 2008, with Calibration Certificate.

Cat. No.	Capacity (ml)	Sub. Div. (ml)	Tolerance ( $\pm$ ml)	Price / Piece Rs.
01.003.11	10	0.05	0.02	1310.00
01.003.12	10	0.02	0.02	1390.00
01.003.13	25	0.1	0.05	1200.00
01.003.14	25	0.05	0.03	1350.00
01.003.15	50	0.1	0.05	1290.00
01.003.17	100	0.2	0.1	1340.00

**N-004** Burettes "RELIGLAS", AMBER, with Straight Bore Glass Key with screw nut retaining provision Stopcock. Accuracy as per Class 'A' of ISO 385/ IS 1997 : 2008, with NABL Certificate.



Cat. No.	Capacity (ml)	Sub. Div. (ml)	Tolerance ( $\pm$ ml)	Price / Piece Rs.
N-004.11	10	0.05	0.02	1700.00
N-004.12	10	0.02	0.02	1800.00
N-004.13	25	0.1	0.05	1700.00
N-004.14	25	0.05	0.03	1875.00
N-004.15	50	0.1	0.05	1750.00
N-004.17	100	0.2	0.1	1780.00

**01.005** Burettes "RELIGLAS", with Straight Bore Glass Key Stopcock. Accuracy as per Class 'B' of ISO 385/ IS 1997:2008.

Cat. No.	Capacity (ml)	Sub. Div. (ml)	Tolerance ( $\pm$ ml)	Price / Piece Rs.
01.005.11	10	0.05	0.05	350.00
01.005.12	10	0.02	0.03	440.00
01.005.13	25	0.1	0.1	275.00
01.005.14	25	0.05	0.05	400.00
01.005.15	50	0.1	0.1	300.00
01.005.17	100	0.2	0.2	400.00

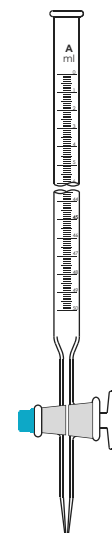

01.001



N-002

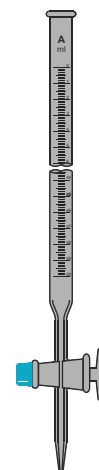

01.003

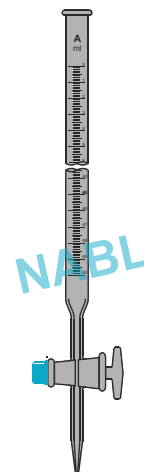

N-004

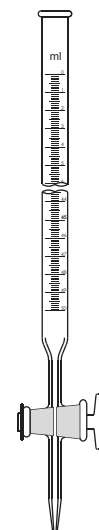

01.005

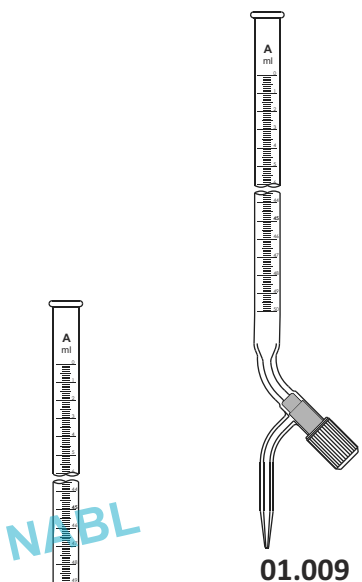

01.009

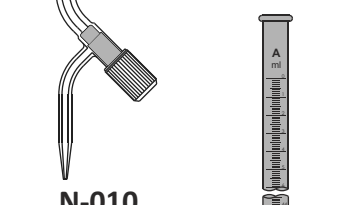

N-010

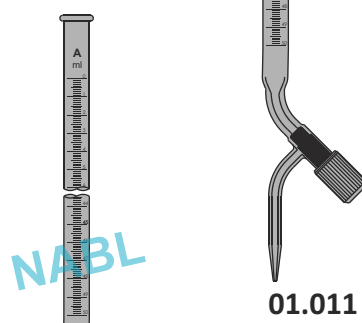

01.011

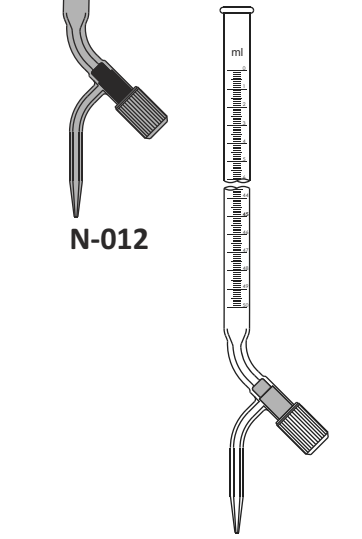

N-012

01.013

01.009 Burettes "RELIGLAS", with Screw Type PTFE Needle Valve Stopcock. Accuracy as per Class 'A' of ISO 385/ IS 1997 : 2008, with Calibration certificate.

Cat. No.	Capacity (ml)	Sub. Div. (ml)	Tolerance ( $\pm$ ml)	Price / Piece Rs.
01.009.11	10	0.05	0.02	770.00
01.009.12	10	0.02	0.02	860.00
01.009.13	25	0.1	0.05	690.00
01.009.14	25	0.05	0.03	870.00
01.009.15	50	0.1	0.05	710.00
01.009.17	100	0.2	0.1	750.00

N-010 Burettes "RELIGLAS", with Screw Type PTFE Needle Valve Stopcock. Accuracy as per Class 'A' of ISO 385/ IS 1997 : 2008, with NABL Certificate.

**NABL**

Cat. No.	Capacity (ml)	Sub. Div. (ml)	Tolerance ( $\pm$ ml)	Price / Piece Rs.
N-010.11	10	0.05	0.02	1420.00
N-010.12	10	0.02	0.02	1550.00
N-010.13	25	0.1	0.05	1390.00
N-010.14	25	0.05	0.03	1540.00
N-010.15	50	0.1	0.05	1400.00
N-010.17	100	0.2	0.1	1435.00

01.011 Burettes "RELIGLAS", AMBER with Screw Type PTFE Needle Valve Stopcock. Accuracy as per Class 'A' of ISO 385/ IS 1997 : 2008, with Calibration certificate.

Cat. No.	Capacity (ml)	Sub. Div. (ml)	Tolerance ( $\pm$ ml)	Price / Piece Rs.
01.011.11	10	0.05	0.02	1290.00
01.011.12	10	0.02	0.02	1370.00
01.011.13	25	0.1	0.05	1170.00
01.011.14	25	0.05	0.03	1325.00
01.011.15	50	0.1	0.05	1250.00
01.011.17	100	0.2	0.1	1350.00

N-012 Burettes "RELIGLAS", AMBER with Screw Type PTFE Needle Valve Stopcock. Accuracy as per Class 'A' of ISO 385/ IS 1997 : 2008, with NABL Certificate.

**NABL**

Cat. No.	Capacity (ml)	Sub. Div. (ml)	Tolerance ( $\pm$ ml)	Price / Piece Rs.
N-012.11	10	0.05	0.02	1950.00
N-012.12	10	0.02	0.02	2025.00
N-012.13	25	0.1	0.05	1950.00
N-012.14	25	0.05	0.03	2025.00
N-012.15	50	0.1	0.05	1975.00
N-012.17	100	0.2	0.1	2000.00

01.013 Burettes "RELIGLAS", with Screw Type PTFE Needle Valve Stopcock. Accuracy as per Class 'B' of ISO 385/ IS 1997 : 2008.

Cat. No.	Capacity (ml)	Sub. Div. (ml)	Tolerance ( $\pm$ ml)	Price / Piece Rs.
01.013.11	10	0.05	0.05	330.00
01.013.12	10	0.02	0.03	425.00
01.013.13	25	0.1	0.1	265.00
01.013.14	25	0.05	0.05	320.00
01.013.15	50	0.1	0.1	280.00
01.013.17	100	0.2	0.2	380.00

01.017 Burettes "RELIGLAS", with Straight Bore PTFE key Stopcock. Accuracy as per Class 'A' of ISO 385/ IS 1997 : 2008 with calibration certificate.

Cat. No.	Capacity (ml)	Sub. Div. (ml)	Tolerance ( $\pm$ ml)	Price / Piece Rs.
01.017.11	10	0.05	0.02	975.00
01.017.12	10	0.02	0.02	1100.00
01.017.13	25	0.1	0.05	900.00
01.017.14	25	0.05	0.03	1025.00
01.017.15	50	0.1	0.05	925.00
01.017.17	100	0.2	0.1	960.00

N-018 Burettes "RELIGLAS", with Straight Bore PTFE key Stopcock. Accuracy as per Class 'A' of ISO 385/ IS 1997 : 2008 with NABL Certificate.



Cat. No.	Capacity (ml)	Sub. Div. (ml)	Tolerance ( $\pm$ ml)	Price / Piece Rs.
N-018.11	10	0.05	0.02	1650.00
N-018.12	10	0.02	0.02	1800.00
N-018.13	25	0.1	0.05	1600.00
N-018.14	25	0.05	0.03	1800.00
N-018.15	50	0.1	0.05	1625.00
N-018.17	100	0.2	0.1	1650.00

01.019 Burettes "RELIGLAS", AMBER with Straight Bore PTFE key Stopcock. Accuracy as per Class 'A' of ISO 385/ IS 1997 : 2008 with calibration certificate.

Cat. No.	Capacity (ml)	Sub. Div. (ml)	Tolerance ( $\pm$ ml)	Price / Piece Rs.
01.019.11	10	0.05	0.02	1400.00
01.019.12	10	0.02	0.02	1500.00
01.019.13	25	0.1	0.05	1375.00
01.019.14	25	0.05	0.03	1475.00
01.019.15	50	0.1	0.05	1400.00
01.019.17	100	0.2	0.1	1500.00

N-020 Burettes "RELIGLAS", AMBER with Straight Bore PTFE key Stopcock. Accuracy as per Class 'A' of ISO 385/ IS 1997 : 2008 with NABL Certificate.



Cat. No.	Capacity (ml)	Sub. Div. (ml)	Tolerance ( $\pm$ ml)	Price / Piece Rs.
N-020.11	10	0.05	0.02	1900.00
N-020.12	10	0.02	0.02	2050.00
N-020.13	25	0.1	0.05	1950.00
N-020.14	25	0.05	0.03	2100.00
N-020.15	50	0.1	0.05	1750.00
N-020.17	100	0.2	0.1	1850.00

01.021 Burettes "RELIGLAS", with Straight Bore PTFE Key Stopcock. Accuracy as per Class 'B' of ISO 385 / IS 1997 : 2008.

Cat. No.	Capacity (ml)	Sub. Div. (ml)	Tolerance ( $\pm$ ml)	Price / Piece Rs.
01.021.11	10	0.05	0.05	610.00
01.021.12	10	0.02	0.05	675.00
01.021.13	25	0.1	0.1	500.00
01.021.14	25	0.05	0.05	600.00
01.021.15	50	0.1	0.1	525.00
01.021.17	100	0.2	0.2	625.00

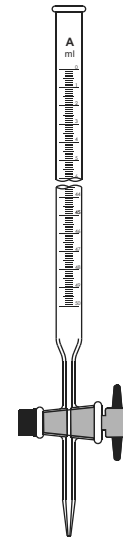

01.017

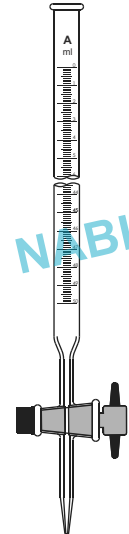

N-018

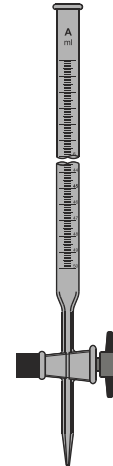

01.019

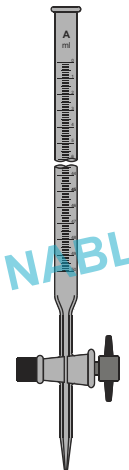

N-020

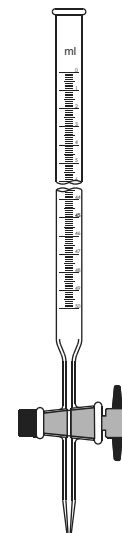

01.021

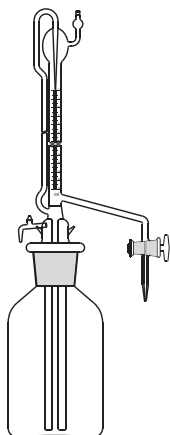

01.025

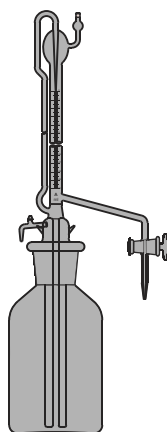

01.027

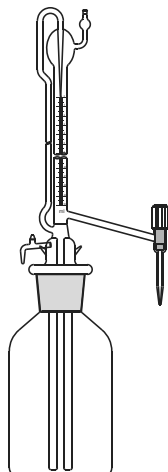

01.029

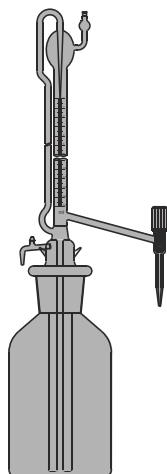

01.031

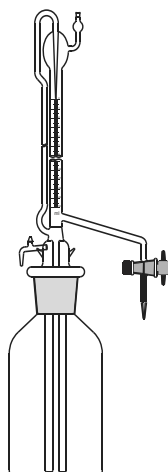

01.033

- 01.025** Burettes "RELIGLAS", Automatic Zero, with Glass Key Stopcock, mounted on Reservoir, Rubber bellow, Accuracy as per Class 'A' of IS 1997 : 2008, with calibration certificate.

Cat. No.	Capacity (ml)	Sub. Div. (ml)	Tolerance ( $\pm$ ml)	Price / Piece Rs.
01.025.11	10	0.05	0.02	5100.00
01.025.13	25	0.1	0.05	5350.00
01.025.14	25	0.05	0.03	6100.00
01.025.15	50	0.1	0.05	5900.00
01.025.17	100	0.2	0.1	6300.00

**Note :** Reservoir Capacity for 10ml burettes is 500ml and for 25, 50 & 100ml burettes is 2000ml.

- 01.027** Burettes "RELIGLAS", AMBER, Automatic Zero, with Glass Key Stopcock, mounted on Reservoir, Rubber bellow, Accuracy as per Class 'A' of IS 1997 : 2008 with calibration certificate.

Cat. No.	Capacity (ml)	Sub. Div. (ml)	Tolerance ( $\pm$ ml)	Price / Piece Rs.
01.027.11	10	0.05	0.02	5900.00
01.027.13	25	0.1	0.05	7200.00
01.027.14	25	0.05	0.03	7500.00
01.027.15	50	0.1	0.05	7700.00
01.027.17	100	0.2	0.1	8000.00

**Note :** Reservoir Capacity for 10ml burettes is 500ml and for 25, 50 & 100ml burettes is 2000ml.

- 01.029** Burettes "RELIGLAS", Automatic Zero, with Screw type PTFE Needle Valve Stopcock, mounted on Reservoir, Rubber bellow, Accuracy as per Class 'A' of IS 1997:2008, with calibration certificate.

Cat. No.	Capacity (ml)	Sub. Div. (ml)	Tolerance ( $\pm$ ml)	Price / Piece Rs.
01.029.11	10	0.05	0.02	5100.00
01.029.13	25	0.1	0.05	5350.00
01.029.14	25	0.05	0.03	6100.00
01.029.15	50	0.1	0.05	5900.00
01.029.17	100	0.2	0.1	6300.00

**Note :** Reservoir Capacity for 10ml burettes is 500ml and for 25, 50 & 100ml burettes is 2000ml.

- 01.031** Burettes "RELIGLAS", AMBER, Automatic Zero, with Screw type PTFE Needle Valve Stopcock, mounted on Reservoir, Rubber bellow, Accuracy as per Class 'A' of IS 1997 : 2008, with calibration certificate.

Cat. No.	Capacity (ml)	Sub. Div. (ml)	Tolerance ( $\pm$ ml)	Price / Piece Rs.
01.031.11	10	0.05	0.02	5900.00
01.031.13	25	0.1	0.05	7200.00
01.031.14	25	0.05	0.03	7500.00
01.031.15	50	0.1	0.05	7700.00
01.031.17	100	0.2	0.1	8000.00

**Note :** Reservoir Capacity for 10ml burettes is 500ml and for 25, 50 & 100ml burettes is 2000ml.

- 01.033** Burettes "RELIGLAS", Automatic Zero, with PTFE Key Stopcock, mounted on Reservoir, Rubber bellow, Accuracy as per Class 'A' of IS 1997 : 2008, with calibration certificate.

Cat. No.	Capacity (ml)	Sub. Div. (ml)	Tolerance ( $\pm$ ml)	Price / Piece Rs.
01.033.11	10	0.05	0.02	5300.00
01.033.13	25	0.1	0.05	5500.00
01.033.14	25	0.05	0.03	6300.00
01.033.15	50	0.1	0.05	6100.00
01.033.17	100	0.2	0.1	6500.00

**Note :** Reservoir Capacity for 10ml burettes is 500ml and for 25, 50 & 100ml burettes is 2000ml.

01.035 Burettes "RELIGLAS", AMBER, Automatic Zero, with PTFE Key Stopcock, mounted on Reservoir, Rubber bellow, Accuracy as per Class 'A' of IS 1997: 2008, with calibration certificate.

Cat. No.	Capacity (ml)	Sub. Div. (ml)	Tolerance ( $\pm$ ml)	Price / Piece Rs.
01.035.11	10	0.05	0.02	6100.00
01.035.13	25	0.1	0.05	7400.00
01.035.14	25	0.05	0.03	7700.00
01.035.15	50	0.1	0.05	7900.00
01.035.17	100	0.2	0.1	8200.00

Note : Reservoir Capacity for 10ml burettes is 500ml and for 25, 50 & 100ml burettes is 2000ml.

01.037 Burettes "RELIGLAS", with Pinch Cock Rubber tubing and glass jet. Accuracy as per Class 'B' of ISO 385/IS 1997:2008.

Cat. No.	Capacity (ml)	Sub. Div. (ml)	Tolerance ( $\pm$ ml)	Price / Piece Rs.
01.037.11	10	0.05	0.05	145.00
01.037.13	25	0.1	0.1	140.00
01.037.15	50	0.1	0.1	160.00

01.038 Burettes, Automatic Zero with PTFE Key Stopcock, for Karl Fisher 'RELIGLAS' Class 'A'.

Cat. No.	Capacity (ml)	Sub. Div. (ml)	Tolerance ( $\pm$ ml)	Price / Piece Rs.
01.038.11	10	0.05	0.02	5200.00
01.038.13	25	0.1	0.05	6000.00

Note : Reservoir Capacity for Karl Fisher burettes is 500ml

01.040.01 Spare Rubber Bellow with cotton Net for Automatic Burette 440.00

01.040.03 Burette Stand Metallic with 20x12cm Heavy base, 60 cm M.S. Rod and Dia Pressed Epoxy Coated Sheet Steel Clamp to Hold one Burette 900.00



## PIPETTES

01.044 Pipettes Transfer Volumetric, "RELIGLAS" accuracy as per Class 'A' of ASTM/ USP standards E969-02 with Certificate. Calibrated at 20°C.

Cat. No.	Capacity (ml)	Tolerance ( $\pm$ ml)	Price / Piece Rs.
01.044.01	1	0.006	185.00
01.044.02	2	0.006	185.00
01.044.03	3	0.01	200.00
01.044.04	4	0.01	200.00
01.044.05	5	0.01	200.00
01.044.06	6	0.01	205.00
01.044.07	7	0.01	210.00
01.044.08	8	0.02	210.00
01.044.09	9	0.02	210.00
01.044.10	10	0.02	215.00
01.044.15	15	0.03	215.00
01.044.20	20	0.03	245.00
01.044.25	25	0.03	250.00
01.044.30	30	0.03	260.00
01.044.40	40	0.05	330.00
01.044.50	50	0.05	370.00
01.044.100	100	0.08	480.00

Note : For AMBER Colour Pipettes of 01.044, Rs. 80.00 Extra.

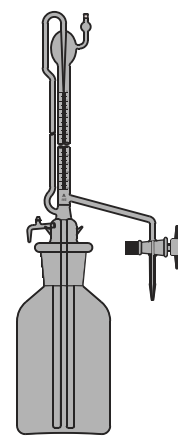

01.035

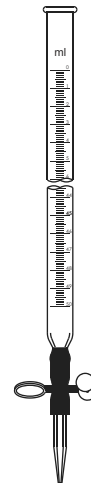

01.037

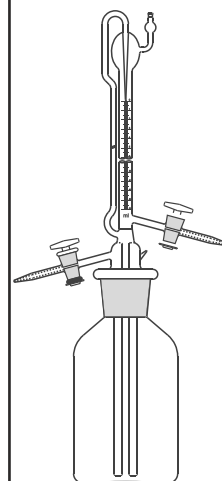

01.038

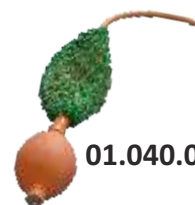

01.040.01



01.040.03

Calibrated at  
20°C  
USP



01.044

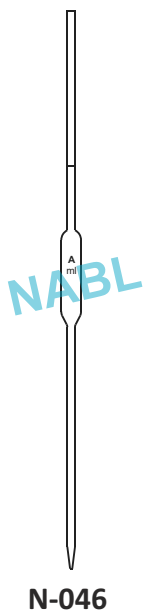
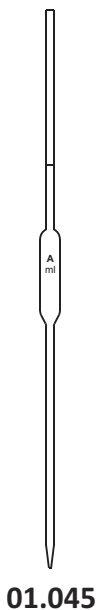
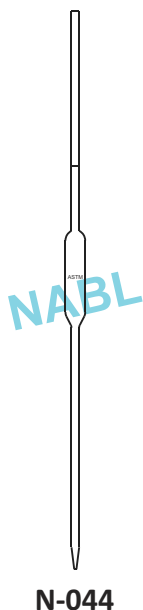

**N-044** Pipettes Transfer Volumetric, "RELIGLAS" accuracy as per Class 'A' of ASTM/ USP E969-02 with Certificate. Calibrated at 20°C with NABL Certificate.



Cat. No.	Capacity (ml)	Tolerance (± ml)	Price / Piece Rs.
N-044.01	1	0.006	330.00
N-044.03	2	0.01	330.00
N-044.05	3	0.01	330.00
N-044.09	4	0.01	330.00
N-044.09	5	0.015	340.00
N-044.11	6	0.015	340.00
N-044.13	7	0.015	340.00
N-044.15	8	0.015	355.00
N-044.17	9	0.02	355.00
N-044.19	10	0.02	355.00
N-044.21	15	0.02	355.00
N-044.23	20	0.03	382.00
N-044.25	25	0.03	382.00
N-044.27	30	0.03	398.00
N-044.29	40	0.05	465.00
N-044.31	50	0.05	475.00
N-044.33	100	0.08	515.00

**01.045** Pipettes Transfer, Volumetric, "RELIGLAS", one mark, Accuracy as per Class 'A' of ISO 648/ IS 1117 : 1975, with calibration certificate.

Cat. No.	Capacity (ml)	Tolerance (± ml)	Price / Piece Rs.
01.045.01	1	0.006	175.00
01.045.05	2	0.01	175.00
01.045.06	3	0.01	175.00
01.045.07	4	0.01	175.00
01.045.10	5	0.015	180.00
01.045.11	6	0.015	180.00
01.045.12	7	0.015	180.00
01.045.13	8	0.015	180.00
01.045.14	9	0.02	180.00
01.045.15	10	0.02	180.00
01.045.18	15	0.02	220.00
01.045.20	20	0.03	220.00
01.045.25	25	0.03	220.00
01.045.30	50	0.05	275.00
01.045.35	100	0.08	380.00

**N-046** Pipettes Transfer, Volumetric, "RELIGLAS", one mark, Accuracy as per Class 'A' of ISO 648/ IS 1117 : 1975, with NABL Certificate.



Cat. No.	Capacity (ml)	Tolerance (± ml)	Price / Piece Rs.
N-046.01	1	0.006	425.00
N-046.05	2	0.01	425.00
N-046.06	3	0.01	425.00
N-046.07	4	0.01	425.00
N-046.10	5	0.015	425.00
N-046.11	6	0.015	425.00
N-046.12	7	0.015	425.00
N-046.13	8	0.015	425.00
N-046.14	9	0.02	425.00
N-046.15	10	0.02	425.00
N-046.18	15	0.02	435.00
N-046.20	20	0.03	440.00
N-046.25	25	0.03	440.00
N-046.30	50	0.05	475.00
N-046.35	100	0.08	525.00

01.047 Pipettes Transfer, Volumetric, "RELIGLAS", one mark. Accuracy as per Class 'B' of ISO 648/IS 1117 : 1975.

Cat. No.	Capacity (ml)	Tolerance (± ml)	Price / Piece Rs.
01.047.01	1	0.015	90.00
01.047.05	2	0.02	90.00
01.047.10	5	0.03	95.00
01.047.15	10	0.04	98.00
01.047.20	20	0.06	110.00
01.047.25	25	0.06	115.00
01.047.30	50	0.1	165.00
01.047.35	100	1.16	240.00

01.048 Pipettes Transfer, Volumetric, "RELIGLAS", AMBER, one mark, Accuracy as per Class 'A' of ISO 648/IS 1117 : 1975, with calibration certificate.

Cat. No.	Capacity (ml)	Tolerance (± ml)	Price / Piece Rs.
01.048.01	1	0.006	250.00
01.048.05	2	0.01	250.00
01.048.06	3	0.01	250.00
01.048.07	4	0.01	250.00
01.048.10	5	0.015	250.00
01.048.15	10	0.02	265.00
01.048.18	15	0.02	280.00
01.048.20	20	0.03	290.00
01.048.25	25	0.03	295.00
01.048.30	50	0.05	370.00
01.048.35	100	0.08	520.00

Note : For NABL Certificate for Cat. No. 01.048, Rs. 300.00 extra.

01.051 Pipettes, Measuring, Graduated, Serological, "RELIGLAS". Accuracy as per Class 'A' with calibration certificate. Color coded. (These pipettes are calibrated to deliver from any graduation line down to zero at the jet, with the last drop expelled by blowing).

Cat. No.	Capacity (ml)	Sub. Div. (ml)	Tolerance (± ml)	Price / Piece Rs.
01.051.01	0.1	0.01	0.006	210.00
01.051.03	0.2	0.01	0.006	210.00
01.051.05	0.5	0.02	0.006	210.00
01.051.07	1	0.01	0.006	210.00
01.051.09	1	0.1	0.006	210.00
01.051.11	2	0.02	0.01	210.00
01.051.13	2	0.1	0.01	210.00
01.051.15	5	0.05	0.03	210.00
01.051.17	5	0.1	0.05	210.00
01.051.19	10	0.1	0.05	210.00
01.051.21	25	0.2	0.1	270.00

N-052 Pipettes, Measuring, Graduated, Serological, "RELIGLAS". Accuracy as per Class 'A' with NABL Certificate. Color coded. (These pipettes are calibrated to deliver from any graduation line down to zero at the jet, with the last drop expelled by blowing).

Cat. No.	Capacity (ml)	Sub. Div. (ml)	Tolerance (± ml)	Price / Piece Rs.
N-052.01	0.1	0.01	0.006	480.00
N-052.03	0.2	0.01	0.006	480.00
N-052.05	0.5	0.02	0.006	480.00
N-052.07	1	0.01	0.006	480.00
N-052.09	1	0.1	0.006	480.00
N-052.11	2	0.02	0.01	480.00
N-052.13	2	0.1	0.01	480.00
N-052.15	5	0.05	0.03	480.00
N-052.17	5	0.1	0.05	480.00
N-052.19	10	0.1	0.05	480.00
N-052.21	25	0.2	0.1	510.00

Note : For AMBER colour Pipettes of Cat. No. 01.051 & N-052, Rs. 200.00 extra.

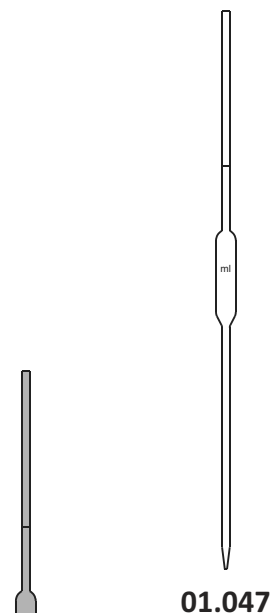

01.047



01.048



01.051

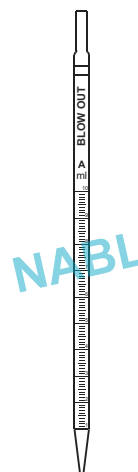

N-052





01.053



01.054

Calibrated at  
20°C  
USP



01.057



N-058

NABL

**01.053** Pipettes, Measuring, Graduated, Serological, "RELIGLAS". Accuracy as per Class 'B' of ISO 1648, Color coded. (These pipettes are calibrated to deliver from any graduation line down to zero at the jet, with the last drop expelled by blowing).

Cat. No.	Capacity (ml)	Sub. Div. (ml)	Tolerance (± ml)	Price / Piece Rs.
01.053.01	0.1	0.01	0.01	110.00
01.053.03	0.2	0.01	0.01	110.00
01.053.05	0.5	0.02	0.01	110.00
01.053.07	1	0.01	0.01	110.00
01.053.09	1	0.1	0.01	110.00
01.053.11	2	0.02	0.02	115.00
01.053.13	2	0.1	0.02	115.00
01.053.15	5	0.05	0.05	115.00
01.053.17	5	0.1	0.1	115.00
01.053.19	10	0.1	0.1	120.00
01.053.21	25	0.2	0.2	135.00

**01.054** Pipettes, Measuring, Graduated, Serological, "RELIGLAS". USP (US Pharmacopia) Class 'A' with calibration certificate. Color coded. Calibrated at 20°C.

Cat. No.	Capacity (ml)	Sub. Div. (ml)	Tolerance (± ml)	Price / Piece Rs.
01.054.07	1	0.1	0.01	270.00
01.054.11	2	0.1	0.01	280.00
01.054.15	5	0.1	0.02	310.00
01.054.19	10	0.1	0.03	320.00
01.054.21	25	0.2	0.05	370.00

**01.057** Pipettes, Measuring, Graduated, Mohr type, "RELIGLAS". Accuracy as per Class 'A' of ISO 835 with calibration certificate. Color coded. (These pipettes are graduated for the delivery from zero mark at top to the last graduation mark.)

Cat. No.	Capacity (ml)	Sub. Div. (ml)	Tolerance (± ml)	Price / Piece Rs.
01.057.01	0.1	0.01	0.006	210.00
01.057.03	0.2	0.01	0.006	210.00
01.057.05	0.5	0.02	0.006	210.00
01.057.07	1	0.01	0.006	210.00
01.057.09	1	0.1	0.006	210.00
01.057.11	2	0.02	0.01	210.00
01.057.13	2	0.1	0.01	210.00
01.057.15	5	0.05	0.03	210.00
01.057.17	5	0.1	0.05	210.00
01.057.19	10	0.1	0.05	210.00
01.057.21	25	0.2	0.1	270.00

**N-058** Pipettes, Measuring, Graduated, Mohr type, "RELIGLAS". Accuracy as per Class 'A' of ISO 835 with NABL Certificate. Color coded. (These pipettes are graduated for the delivery from zero mark at top to the last graduation mark.) Pipette tips are machine made.

NABL

Cat. No.	Capacity (ml)	Sub. Div. (ml)	Tolerance (± ml)	Price / Piece Rs.
N-058.01	0.1	0.01	0.006	480.00
N-058.03	0.2	0.01	0.006	480.00
N-058.05	0.5	0.02	0.006	480.00
N-058.07	1	0.01	0.006	480.00
N-058.09	1	0.1	0.006	480.00
N-058.11	2	0.02	0.01	480.00
N-058.13	2	0.1	0.01	480.00
N-058.15	5	0.05	0.03	480.00
N-058.17	5	0.1	0.05	480.00
N-058.19	10	0.1	0.05	480.00
N-058.21	25	0.2	0.1	510.00

Note : For AMBER Color on Pipettes 01.053 to 01.058, Rs. 200.00 extra.

**01.059** Pipettes, Measuring, Graduated, Mohr type, "RELIGLAS". Accuracy as per Class 'B' of ISO 835. Color coded. (These pipettes are graduated for delivery from zero mark at top to the last graduation mark.) Pipette tips are machine made.

Cat. No.	Capacity (ml)	Sub. Div. (ml)	Tolerance ( $\pm$ ml)	Price / Piece Rs.
01.059.01	0.1	0.01	0.01	110.00
01.059.03	0.2	0.01	0.01	110.00
01.059.05	0.5	0.02	0.01	110.00
01.059.07	1	0.01	0.01	110.00
01.059.09	1	0.1	0.01	110.00
01.059.11	2	0.02	0.02	115.00
01.059.13	2	0.1	0.02	115.00
01.059.15	5	0.05	0.05	115.00
01.059.17	5	0.1	0.1	115.00
01.059.19	10	0.1	0.1	120.00
01.059.21	25	0.2	0.2	135.00

**01.061** Pipettes, Measuring, Graduated, Mohr type, "RELIGLAS". USP (US Pharmacopoeia) Class 'A' with calibration certificate. Color coded. (These pipettes are graduated for the delivery from zero mark at top to the last graduation mark.) Pipette tips are machine made. **Calibrated at 20°C.**

Cat. No.	Capacity (ml)	Sub. Div. (ml)	Tolerance ( $\pm$ ml)	Price / Piece Rs.
01.061.01	0.1	0.01	0.006	270.00
01.061.03	0.2	0.01	0.006	270.00
01.061.05	0.5	0.02	0.006	270.00
01.061.07	1	0.01	0.006	270.00
01.061.09	2	0.02	0.01	280.00
01.061.11	5	0.05	0.02	310.00
01.061.13	10	0.1	0.03	320.00
01.061.15	25	0.2	0.05	370.00

**Note :** For AMBER Color Pipettes of 01.059 & 01.061, Rs. 200.00 extra.

**01.065** Pipettes Automatic "RELIGLAS" Quick acting for rapid work of approximate accuracy (Tilt Measure) complete with Conical Flask, joint fitting.

Cat. No.	Capacity (ml)	Reservoir Capacity (ml)	Price / Piece Rs.
01.065.01	1	100	550.00
01.065.03	2	100	550.00
01.065.05	5	250	600.00
01.065.07	10	250	600.00
01.065.09	20	500	630.00
01.065.11	25	500	630.00

**01.067** Pipette for Milk Test "RELIGLAS", Bacteriological, Graduated as per IS Specifications No. 2025 : 1962.

Cat. No.	Capacity (ml)	Sub. Div. (ml)	Tolerance ( $\pm$ ml)	Price / Piece Rs.
01.067.01	1.1	0.5, 1 & 1.1	0.025	150.00
01.067.03	2.2	1.0, 2.0, 2.1 & 2.2	0.04	160.00

**01.068.01** Pipette for Milk Testing, "RELIGLAS", 10.75ml, One Mark **110.00**

**01.068.03** Pipette for Milk Testing, "RELIGLAS", 10.75ml, One Mark, Class 'A' with Certificate **165.00**

**N-068.05** Pipette for Milk Testing, "RELIGLAS", 10.75ml, One Mark, Class 'A' with NABL Certificate **440.00**

**01.068.15** Pipette Alcohol, "RELIGLAS", 1 ml, One Mark **45.00**

**01.069** Pipette E.S.R. "RELIGLAS" 200 mm. graduation, 300 mm long **48.00**

**01.071.03** Pipette, Pasteur, Disposable, Glass, 230mm long (Pack of 200) **2000.00**

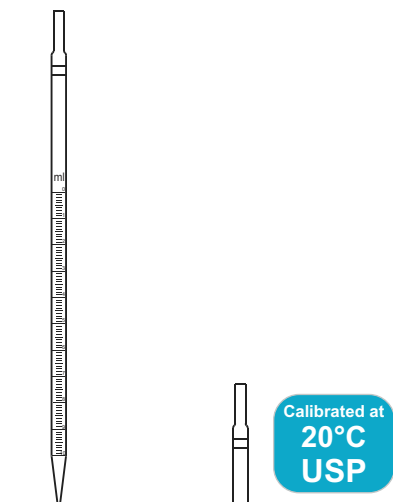

01.059

01.061

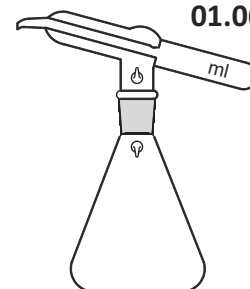

01.065

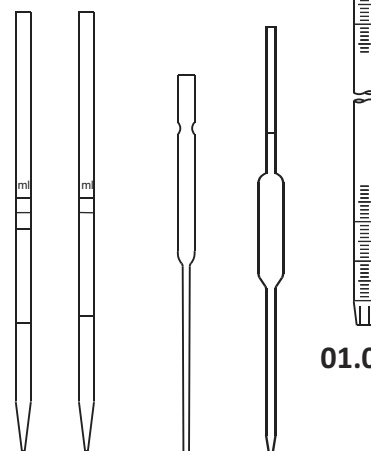

01.067

01.068

01.069

01.071.03

Volumetric / Graduated Glassware



01.075

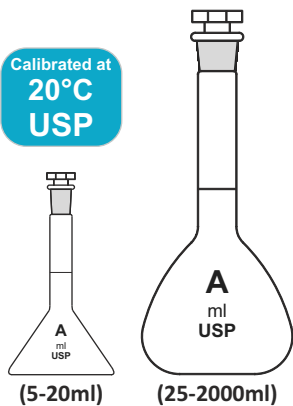

01.079

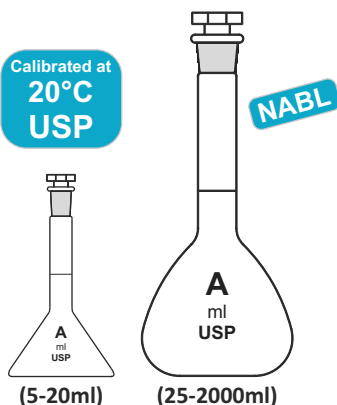

N-079

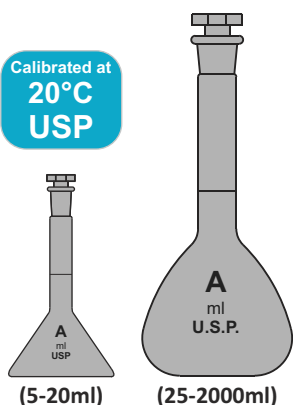

01.080

01.075 Pipette Bulb, Silicon.

Cat. No.	Size	Capacity	Price / Piece (Rs.)
01.075.01	Small	for 5 ml	57.00
01.075.03	Medium	for 10 ml	77.00
01.075.05	Large	for 15 ml	93.00
01.075.07	Extra Large	for 20 ml	110.00
01.075.09	Oval Shape	for 25 ml	200.00
01.075.11	XX Large	for 50 ml	400.00
01.075.13	XXX Large	for 100 ml	520.00



VOLUMETRIC FLASK

01.079 Flask Volumetric, "RELIGLAS" with Interchangeable Stopper, Accuracy as per 'ASTM E-288' Class 'A', USP (US Pharmacopeia), with Calibration Certificate.

Cat. No.	Capacity (ml)	Tolerance (± ml)	Stopper Size	Price / Piece Rs.
01.079.05	5	0.02	10/19	400.00
01.079.07	10	0.02	10/19	405.00
01.079.09	20	0.03	10/19	410.00
01.079.11	25	0.03	10/19	410.00
01.079.13	50	0.05	12/21	420.00
01.079.15	100	0.08	14/23	440.00
01.079.17	200	0.1	14/23	550.00
01.079.19	250	0.12	14/23	550.00
01.079.21	500	0.2	19/26	800.00
01.079.23	1000	0.3	19/26	1080.00
01.079.25	2000	0.5	24/29	2250.00

N-079 Flask Volumetric, "RELIGLAS" with Interchangeable Stopper, Accuracy as per 'ASTM E-288' Class 'A', USP (US Pharmacopeia), with Calibration Certificate.



Cat. No.	Capacity (ml)	Tolerance (± ml)	Stopper Size	Price / Piece Rs.
N-079.05	5	0.02	10/19	555.00
N-079.07	10	0.02	10/19	565.00
N-079.09	20	0.03	10/19	540.00
N-079.11	25	0.03	10/19	540.00
N-079.13	50	0.05	12/21	545.00
N-079.15	100	0.08	14/23	560.00
N-079.17	200	0.1	14/23	670.00
N-079.19	250	0.12	14/23	670.00
N-079.21	500	0.2	19/26	960.00
N-079.23	1000	0.3	19/26	1220.00
N-079.25	2000	0.5	24/29	2750.00

01.080 Flasks, Volumetric, "RELIGLAS", AMBER with I/C stopper Accuracy as per ASTM E288, Class 'A', USP (US Pharmacopeia), with Certificate.

Cat. No.	Capacity (ml.)	Tolerance (±ml)	Stopper Size	Price / Piece Rs.
01.080.05	5	0.02	10/19	475.00
01.080.07	10	0.02	10/19	490.00
01.080.09	20	0.03	10/19	500.00
01.080.11	25	0.03	10/19	510.00
01.080.13	50	0.05	12/21	520.00
01.080.15	100	0.08	14/23	580.00
01.080.17	200	0.1	14/23	700.00
01.080.19	250	0.12	14/23	720.00
01.080.21	500	0.2	19/26	1100.00
01.080.23	1000	0.3	19/26	1500.00
01.080.25	2000	0.5	24/29	2750.00

**01.081** Flask Volumetric "RELIGLAS" with interchangeable stopper, accuracy as per Class 'A' of ISO 1042/IS 915 : 2012, with calibration certificate. **Calibrated at 27°C**

Cat. No.	Capacity (ml)	Tolerance (±ml)	Stopper Size	Price / Piece Rs.
01.081.01	* 1	0.015	10/19	275.00
01.081.03	* 2	0.015	10/19	275.00
01.081.04	**4	0.02	10/19	270.00
01.081.05	5	0.025	10/19	270.00
01.081.07	10	0.025	10/19	280.00
01.081.08	**15	0.025	10/19	300.00
01.081.09	20	0.04	10/19	300.00
01.081.11	25	0.04	10/19	300.00
01.081.30	**30	0.04	10/19	310.00
01.081.12	**40	0.06	10/19	340.00
01.081.13	50	0.06	12/21	340.00
01.081.14	**75	0.06	14/23	380.00
01.081.15	100	0.1	14/23	370.00
01.081.16	**150	0.1	14/23	480.00
01.081.17	200	0.15	14/23	480.00
01.081.19	250	0.15	14/23	480.00
01.081.20	**300	0.15	14/23	620.00
01.081.21	500	0.25	19/26	630.00
01.081.22	**900	0.1	19/29	1090.00
01.081.23	1000	0.4	19/26	1050.00
01.081.24	**1500	0.6	19/26	2100.00
01.081.25	2000	0.6	24/29	1950.00
01.081.27	5000	1.2	34/35	9900.00

Note: Color Code for easy identification of Flasks can be provided @ Rs. 60.00 Extra.  
 \*1 & 2 ml flasks are Test Tube Shape. \*\* are not covered in ISO/IS Standards.

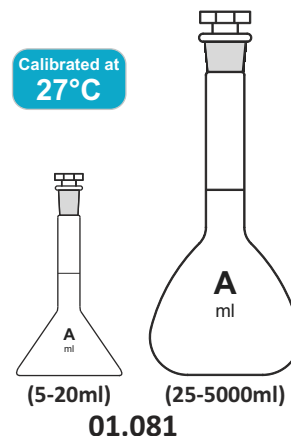

**A1.081** Flask Volumetric "RELIGLAS" with interchangeable stopper, accuracy as per Class 'A', with calibration certificate. **Calibrated at 20°C**

NEW

Cat. No.	Capacity (ml)	Tolerance (±ml)	Stopper Size	Price / Piece Rs.
A1.081.01	* 1	0.015	10/19	275.00
A1.081.03	* 2	0.015	10/19	275.00
A1.081.04	4	0.02	10/19	270.00
A1.081.05	5	0.025	10/19	220.00
A1.081.07	10	0.025	10/19	230.00
A1.081.08	15	0.025	10/19	300.00
A1.081.09	20	0.04	10/19	250.00
A1.081.11	25	0.04	10/19	250.00
A1.081.30	30	0.04	10/19	310.00
A1.081.12	40	0.06	10/19	340.00
A1.081.13	50	0.06	12/21	265.00
A1.081.14	75	0.06	14/23	380.00
A1.081.15	100	0.1	14/23	325.00
A1.081.16	150	0.1	14/23	480.00
A1.081.17	200	0.15	14/23	480.00
A1.081.19	250	0.15	14/23	480.00
A1.081.20	300	0.15	14/23	620.00
A1.081.21	500	0.25	19/26	630.00
A1.081.22	900	0.1	19/26	1090.00
A1.081.23	1000	0.4	19/26	1050.00
A1.081.24	1500	0.6	19/26	2100.00
A1.081.25	2000	0.6	24/29	1950.00
A1.081.27	5000	1.2	34/35	10500.00

Note: \*1 & 2 ml flasks are Test Tube Shape.

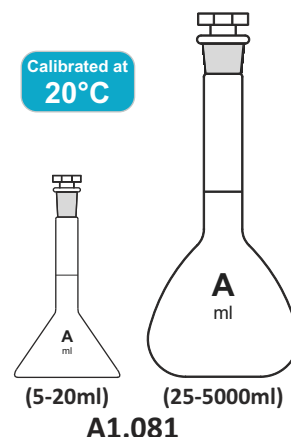

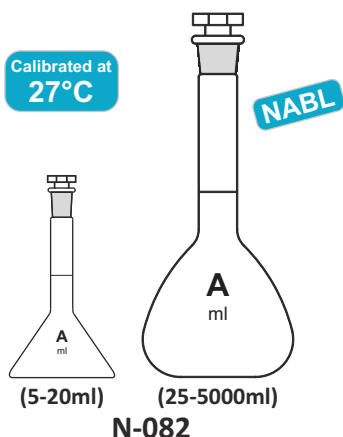

N-082 Flask Volumetric, "RELIGLAS" with Interchangeable Stopper, Accuracy as per Class 'A' ISO 1042 / IS 915 : 2012, with NABL Certificate.

NABL

Cat. No.	Capacity (ml)	Tolerance ( $\pm$ ml)	Stopper Size	Price / Piece Rs.
N-082.01	1*	0.015	10/19	495.00
N-082.03	2*	0.015	10/19	495.00
N-082.04	4**	0.02	10/19	500.00
N-082.05	5	0.025	10/19	500.00
N-082.07	10	0.025	10/19	505.00
N-082.08	15**	0.025	10/19	510.00
N-082.09	20	0.04	10/19	510.00
N-082.11	25	0.04	10/19	510.00
N-082.13	50	0.06	12/21	520.00
N-082.15	100	0.1	14/23	530.00
N-082.17	200	0.15	14/23	640.00
N-082.19	250	0.15	14/23	640.00
N-082.21	500	0.25	19/26	870.00
N-082.23	1000	0.4	19/26	1075.00
N-082.25	2000	0.6	24/29	2100.00
N-082.27	5000	1.2	34/35	10500.00

Note: \* 1 ml. and 2 ml. Volumetric Flasks are of Test Tube shape.

\*\* are not covered in ISO/IS Standards

5, 10 & 20ml Volumetric Flasks supplied in Trapezoidal shape.

Color Code for easy identification of Flasks can be provided @ Rs. 60.00 Extra.

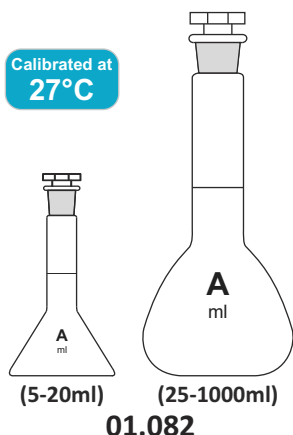

01.082 Flask, Volumetric "RELIGLAS" Wide Mouth, Class 'A' with interchangeable stopper, with calibration certificate.

Cat. No.	Capacity (ml)	Tolerance ( $\pm$ ml)	Stopper Size	Price / Piece Rs.
01.082.05	5	0.04	10/19	380.00
01.082.07	10	0.04	14/23	400.00
01.082.09	20	0.06	14/23	425.00
01.082.11	25	0.06	14/23	425.00
01.082.13	50	0.1	14/23	435.00
01.082.15	100	0.1	19/26	450.00
01.082.17	200	0.15	19/26	570.00
01.082.19	250	0.15	19/26	570.00
01.082.21	500	0.3	24/29	800.00
01.082.23	1000	0.6	29/32	1200.00

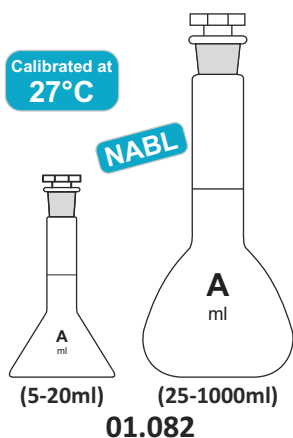

N-W82 Flask, Volumetric "RELIGLAS" Wide Mouth, Class 'A' with interchangeable stopper, with calibration certificate.

NABL

Cat. No.	Capacity (ml)	Tolerance ( $\pm$ ml)	Stopper Size	Price / Piece Rs.
N-W82.05	5	0.04	10/19	660.00
N-W82.07	10	0.04	14/23	660.00
N-W82.09	20	0.06	14/23	660.00
N-W82.11	25	0.06	14/23	660.00
N-W82.13	50	0.1	14/23	660.00
N-W82.15	100	0.1	19/26	690.00
N-W82.17	200	0.15	19/26	880.00
N-W82.19	250	0.15	19/26	880.00
N-W82.21	500	0.3	24/29	1200.00
N-W82.23	1000	0.6	29/32	1950.00

**01.A82** Flask, Volumetric "RELIGLAS", Wide Mouth, AMBER, Class 'A' with interchangeable stopper, with calibration certificate.

**NEW**

Cat. No.	Capacity (ml)	Tolerance (± ml)	Stopper Size	Price / Piece Rs.
01.A82.05	5	0.04	10/19	480.00
01.A82.07	10	0.04	14/23	520.00
01.A82.09	20	0.06	14/23	550.00
01.A82.11	25	0.06	14/23	550.00
01.A82.13	50	0.1	14/23	560.00
01.A82.15	100	0.1	19/26	600.00
01.A82.17	200	0.15	19/26	770.00
01.A82.19	250	0.15	19/26	770.00
01.A82.21	500	0.3	24/29	1050.00
01.A82.23	1000	0.6	29/32	1500.00

**N-A82** Flask, Volumetric "RELIGLAS", Wide Mouth, AMBER, Class 'A' with interchangeable stopper, with calibration certificate.

**NABL**

Cat. No.	Capacity (ml)	Tolerance (± ml)	Stopper Size	Price / Piece Rs.
N-A82.05	5	0.04	10/19	860.00
N-A82.07	10	0.04	14/23	860.00
N-A82.09	20	0.06	14/23	860.00
N-A82.11	25	0.06	14/23	860.00
N-A82.13	50	0.1	14/23	840.00
N-A82.15	100	0.1	19/26	875.00
N-A82.17	200	0.15	19/26	910.00
N-A82.19	250	0.15	19/26	910.00
N-A82.21	500	0.3	24/29	1650.00
N-A82.23	1000	0.6	29/32	2150.00

**01.083** Flask Volumetric, "RELIGLAS", AMBER, with interchangeable stopper, accuracy as per Class 'A' of ISO 1042/ IS 915 : 2012, with calibration certificate.

Cat. No.	Capacity (ml)	Tolerance (±ml)	Stopper Size	Price / Piece Rs.
01.083.01	1*	0.015	10/19	350.00
01.083.03	2*	0.015	10/19	350.00
01.083.04	4**	0.02	10/19	360.00
01.083.05	5	0.025	10/19	370.00
01.083.07	10	0.025	10/19	380.00
01.083.08	15**	0.025	10/19	400.00
01.083.09	20	0.04	10/19	400.00
01.083.11	25	0.04	10/19	410.00
01.083.30	30**	0.04	10/19	440.00
01.083.12	40**	0.06	10/19	440.00
01.083.13	50	0.06	12/21	440.00
01.083.14	75**	0.06	12/21	470.00
01.083.15	100	0.1	14/23	470.00
01.083.16	150**	0.1	14/23	550.00
01.083.17	200	0.15	14/23	600.00
01.083.19	250	0.15	14/23	600.00
01.083.20	300**	0.15	14/23	650.00
01.083.21	500	0.25	19/26	1050.00
01.083.22	900**	0.1	19/26	1500.00
01.083.23	1000	0.4	19/26	1500.00
01.083.24	1500**	0.6	19/26	2700.00
01.083.25	2000	0.6	24/29	2700.00
01.083.27	5000	1.2	34/35	15000.00

**Note:** \* 1 ml. and 2 ml. Flasks are of Test Tube shape. \*\* are not covered in Standards 5, 10 & 20ml Volumetric Flasks supplied in Trapezoidal shape. Color Code for easy identification of Flasks can be provided @ Rs. 60.00 Extra.

Calibrated at 27°C

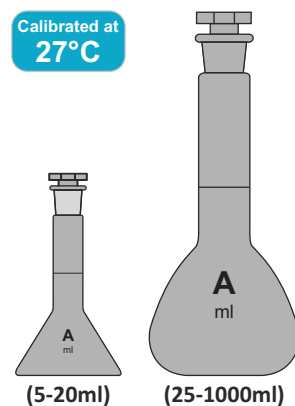

01.A82

Calibrated at 27°C

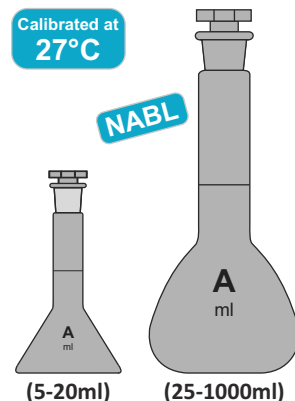

N-A82

Calibrated at 27°C

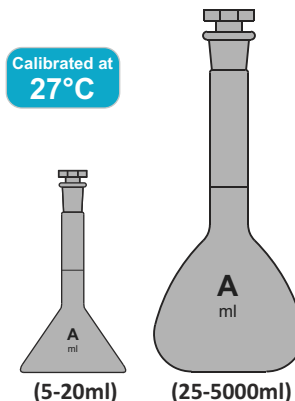

01.083

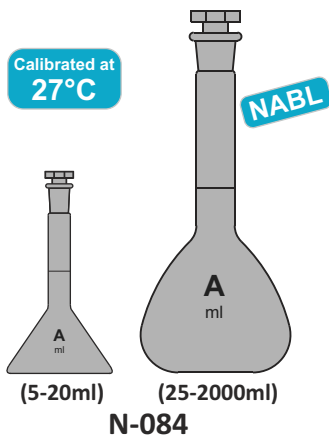

N-084

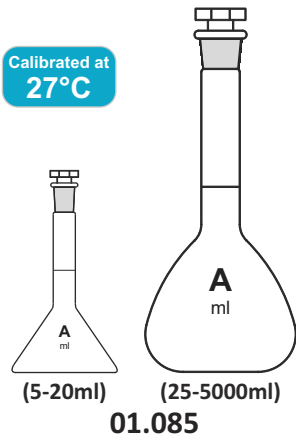

01.085

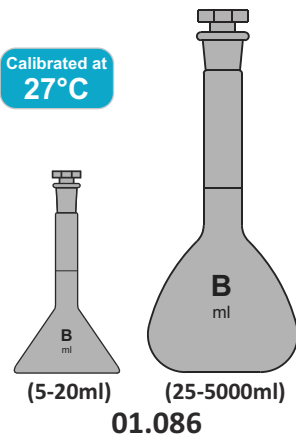

01.086

N-084 Flask Volumetric, "RELIGLAS", AMBER, with Interchangeable Stopper, Accuracy as per ISO 1042/ IS 915 : 2012, Class 'A' with NABL Certificate.

NABL				
Cat. No.	Capacity (ml)	Tolerance (±ml)	Stopper Size	Price / Piece
N.084.01	*1	0.015	10/19	570.00
N.084.03	*2	0.015	10/19	570.00
N.084.05	5	0.025	10/19	580.00
N.084.07	10	0.025	10/19	600.00
N.084.09	20	0.04	10/19	650.00
N.084.11	25	0.04	10/19	650.00
N.084.13	50	0.06	12/21	680.00
N.084.15	100	0.1	14/23	720.00
N.084.17	200	0.15	14/23	950.00
N.084.19	250	0.15	14/23	950.00
N.084.21	500	0.25	19/26	1340.00
N.084.23	1000	0.4	19/26	1900.00
N.084.25	2000	0.6	24/29	3200.00

Note : \* 1 ml. and 2 ml. Volumetric Flasks are of Test Tube shape.

01.085 Flask Volumetric "RELIGLAS" with interchangeable stopper, accuracy as per Class 'B' of ISO 1042/IS 915 : 2012.

Cat. No.	Capacity (ml)	Tolerance (±ml)	Stopper Size	Price / Piece Rs.
01.085.01	* 1	0.03	10/19	120.00
01.085.03	* 2	0.03	10/19	120.00
01.085.05	5	0.05	10/19	120.00
01.085.07	10	0.05	10/19	125.00
01.085.09	20	0.08	10/19	140.00
01.085.11	25	0.08	10/19	140.00
01.085.13	50	0.12	10/19	160.00
01.085.15	100	0.2	14/23	170.00
01.085.17	200	0.3	14/23	240.00
01.085.19	250	0.3	14/23	240.00
01.085.21	500	0.5	19/26	375.00
01.085.23	1000	0.8	19/26	600.00
01.085.25	2000	1.2	24/29	1250.00
01.085.27	5000	2.5	34/35	6200.00

Note : \* 1 ml. and 2 ml. Volumetric Flasks are of Test Tube shape.

01.086 Flask Volumetric "RELIGLAS" AMBER with interchangeable stopper, accuracy as per Class 'B' of ISO 1042/IS 915 : 2012.

Cat. No.	Capacity (ml)	Tolerance (±ml)	Stopper Size	Price / Piece Rs.
01.086.01	* 1	0.03	10/19	210.00
01.086.03	* 2	0.03	10/19	210.00
01.086.05	5	0.05	10/19	230.00
01.086.07	10	0.05	10/19	250.00
01.086.09	20	0.08	10/19	290.00
01.086.11	25	0.08	10/19	290.00
01.086.13	50	0.12	10/19	320.00
01.086.15	100	0.2	14/23	355.00
01.086.17	200	0.3	14/23	540.00
01.086.19	250	0.3	14/23	540.00
01.086.21	500	0.5	19/26	960.00
01.086.23	1000	0.8	19/26	1250.00
01.086.25	2000	1.2	24/29	2500.00
01.086.27	5000	2.5	34/35	9500.00

Note : \* 1 ml. and 2 ml. Volumetric Flasks are of Test Tube shape.

01.087 PTFE Stoppers for Volumetric Flasks

Cat. No.	Stopper Size	Price / Piece Rs.
01.087.02	10/19	160.00
01.087.03	12/21	160.00
01.087.04	14/23	180.00
01.087.06	19/26	240.00
01.087.08	24/29	350.00

Polypropylene (PP) stoppers for volumetric flasks

Cat. No.	Stopper Size	Price / Piece Rs.
01.087.12	10/19	8.00
01.087.13	12/21	9.00
01.087.14	14/23	11.00
01.087.16	19/26	15.00
01.087.18	24/29	20.00
01.087.20	29/32	24.00
01.087.22	34/35	50.00

01.089 Flask, Petroleum Test "RELIGLAS" with pour our, with NABL certificate, calibrated as per weight and measure guidelines. Capacity 5000ml **Rs. 5400.00**

01.091 Flasks Volumetric "RELIGLAS" Sugar estimation with two marks without stopper accuracy as per B.S. 675 : 1953.

Cat. No.	Capacity (ml)	Price / Piece Rs.
01.091.01	marked at 50 ml. and 55 ml	200.00
01.091.03	— do — 100 ml. and 110 ml	250.00
01.091.05	— do — 200 ml. and 220 ml	300.00

01.091A Flask "RELIGLAS" Sugar estimation, Class 'A'

Cat. No.	Capacity (ml)	Price / Piece Rs.
01.091.01A	50-55	350.00
01.091.03A	100-110	400.00
01.091.05A	200-220	450.00

N-091 Flask "RELIGLAS" Sugar estimation, Class 'A'

Cat. No.	Capacity (ml)	Price / Piece Rs.
N-091.01	50-55	500.00
N-091.03	100-110	530.00
N-091.05	200-220	650.00

01.093 Kohlraush Flasks (Mud Flask) "RELIGLAS" with cup at top.

Cat. No.	Capacity (ml)	Tolerance (± ml)	Price / Piece Rs.
01.093.01	50	0.04	185.00
01.093.03	100	0.06	215.00
01.093.05	200	0.1	300.00

01.093A Kohlraush Flasks (Mud Flask) "RELIGLAS" with cup at top, Class 'A'.

Cat. No.	Capacity (ml)	Price / Piece Rs.
01.093.01A	50-55	305.00
01.093.03A	100-110	330.00
01.093.05A	200-220	440.00

01.095 Lechatelier Flask, "RELIGLAS" for Sp. Gr. Test 250 ml., Neck graduation from 0 to 1 ml. and 18 to 24 ml. in 0.1 ml. **1200.00**

01.096 Lechatelier Flask, "RELIGLAS" for Sp. Gr. Test 250 ml., Neck graduation from 0 to 1 ml. and 18 to 24 ml. in 0.1 ml. Accuracy as per Class 'A', with Calibration Certificate **1650.00**

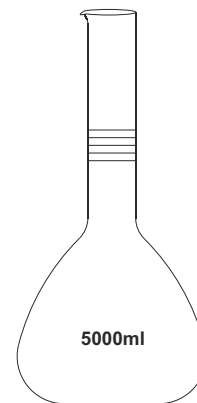
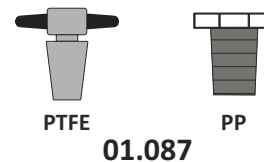

01.089

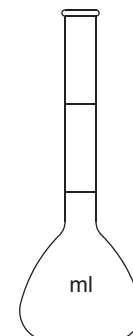

01.091/ 01.091A/ N-091

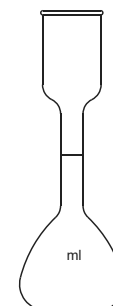

01.093/ 01.093A

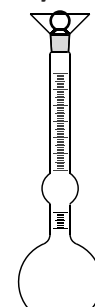

01.095/ 01.096



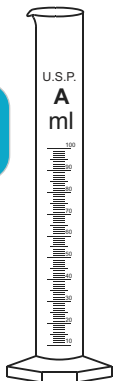
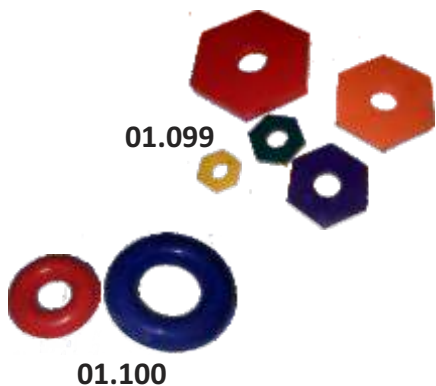

Calibrated at  
20°C  
USP

01.102

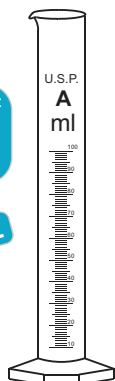

Calibrated at  
20°C  
USP

NABL

N-102

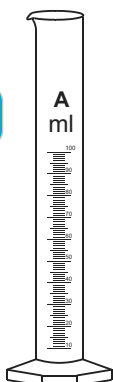

Calibrated at  
27°C

01.103

01.099 Silicon Rubber, Safety Rider, Hexagonal Shape for Volumetric Flask

NEW

Cat. No.	For Flask Capacity (ml)	Colour	Price / Piece Rs.
01.099.01	5-25	Yellow	40.00
01.099.03	50	Green	52.00
01.099.05	100-250	Blue	100.00
01.099.07	500	Orange	220.00
01.099.09	1000	Red	400.00

01.100.01 Rings, Weight, Silicon Coated for Volumetric Flask (5ml-50ml) 720.00

01.100.03 Rings, Weight, Silicon Coated for Volumetric Flask (100ml-1 ltr) 950.00

MEASURING CYLINDERS

01.102 Measuring Cylinders "RELIGLAS", Accuracy as per ASTM E1272 Class 'A' USP (US Pharmacopeia) with certificate, with AMBER stain graduation.

Cat. No.	Capacity (ml)	Sub. Div. (ml)	Tolerance (±ml)	Price/Piece Rs.
01.102.01	5	0.1	0.05	300.00
01.102.03	10	0.2	0.1	320.00
01.102.05	25	0.5	0.17	370.00
01.102.07	50	1	0.25	460.00
01.102.09	100	1	0.5	540.00
01.102.11	250	2	1	840.00
01.102.13	500	5	2	1200.00
01.102.15	1000	10	3	1400.00
01.102.17	2000	20	6	2250.00

N-102 Measuring Cylinders "RELIGLAS", Accuracy as per ASTM E1272 Class 'A' USP (US Pharmacopeia) with certificate, with AMBER stain graduation.

NABL

Cat. No.	Capacity (ml)	Sub. Div. (ml)	Tolerance (±ml)	Price/Piece Rs.
N-102.01	5	0.1	0.05	610.00
N-102.03	10	0.2	0.1	630.00
N-102.05	25	0.5	0.17	720.00
N-102.07	50	1	0.25	900.00
N-102.09	100	1	0.5	980.00
N-102.11	250	2	1	1150.00
N-102.13	500	5	2	1400.00
N-102.15	1000	10	3	1750.00
N-102.17	2000	20	6	2800.00

01.103 Measuring Cylinders, "RELIGLAS", with spout, Hexagonal Base, Class 'A' with calibration certificate. With AMBER stain graduation. Complies with IS 878, ENISO 4788.

Cat. No.	Capacity (ml)	Sub. Div. (ml)	Tolerance (± ml)	Price / Piece Rs.
01.103.01	5	0.1	0.05	305.00
01.103.03	10	0.2	0.1	315.00
01.103.04	20*	0.5	0.25	400.00
01.103.05	25	0.5	0.25	355.00
01.103.07	50	1	0.5	425.00
01.103.09	100	1	0.5	510.00
01.103.13	150*	2	1	600.00
01.103.11	250	2	1	750.00
01.103.13	500	5	2.5	1080.00
01.103.15	1000	10	5	1320.00
01.103.17	2000	20	10	2200.00

Note : \* 20 ml and 150 ml Measuring Cylinders are not covered in any standard.

**N-104** Measuring Cylinders, "RELIGLAS", with spout, Hexagonal Base, Class 'A' with NABL Certificate. With AMBER stain graduation.



Cat. No.	Capacity (ml)	Sub. Div. (ml)	Tolerance (± ml)	Price / Piece Rs.
N-104.01	5	0.1	0.05	660.00
N-104.03	10	0.2	0.1	680.00
N-104.04	20	0.5	0.25	700.00
N-104.05	25	0.5	0.25	700.00
N-104.07	50	1	0.5	770.00
N-104.09	100	1	0.5	840.00
N-104.10	150	2	1	1400.00
N-104.11	250	2	1	1040.00
N-104.13	500	5	2.5	1400.00
N-104.15	1000	10	5	1680.00
N-104.17	2000	20	10	2700.00

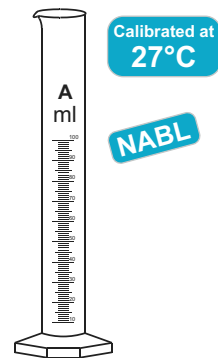

**N-104**

**01.105** Measuring Cylinders, "RELIGLAS", AMBER, with spout, Hexagonal Base, Class 'A' with calibration certificate.

Cat. No.	Capacity (ml)	Sub. Div. (ml)	Tolerance (± ml)	Price / Piece Rs.
01.105.01	5	0.1	0.05	410.00
01.105.03	10	0.2	0.1	440.00
01.105.05	25	0.5	0.25	510.00
01.105.07	50	1	0.5	570.00
01.105.09	100	1	0.5	700.00
01.105.11	250	2	1	1050.00
01.105.13	500	5	2.5	1520.00
01.105.15	1000	10	5	2140.00
01.105.17	2000	20	10	3300.00

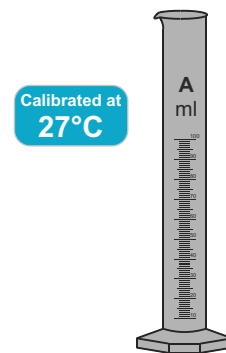

**01.105**

**N-106** Measuring Cylinders, "RELIGLAS", AMBER, with spout, Hexagonal Base, Class 'A' with NABL Certificate.



Cat. No.	Capacity (ml)	Sub. Div. (ml)	Tolerance (± ml)	Price / Piece Rs.
N-106.01	5	0.1	0.05	730.00
N-106.03	10	0.2	0.1	740.00
N-106.05	25	0.5	0.25	765.00
N-106.07	50	1	0.5	860.00
N-106.09	100	1	0.5	940.00
N-106.11	250	2	1	1230.00
N-106.13	500	5	2.5	1640.00
N-106.15	1000	10	5	2240.00
N-106.17	2000	20	10	3500.00

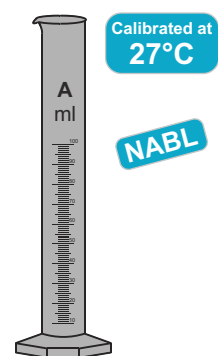

**N-106**

**01.107** Measuring Cylinders, "RELIGLAS", with spout, Hexagonal Base, Thick Wall, accuracy as per ISO 4788/IS 878:2008, Class 'B'. With AMBER stain graduation.

Cat. No.	Capacity (ml)	Sub. Div. (ml)	Tolerance (± ml)	Price / Piece Rs.
01.107.01	5	0.1	0.1	200.00
01.107.03	10	0.2	0.2	208.00
01.107.05	25	0.5	0.5	240.00
01.107.07	50	1	1	264.00
01.107.09	100	1	1	308.00
01.107.10	150*	2	2	395.00
01.107.11	250	2	2	550.00
01.107.13	500	5	5	660.00
01.107.15	1000	10	10	1100.00
01.107.17	2000	20	20	2000.00

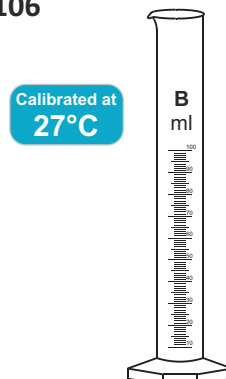

**01.107**

Note : \* 150 ml Measuring Cylinder is not covered in any standard.

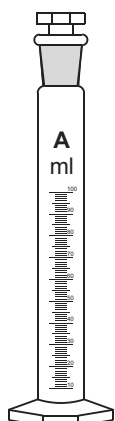

Calibrated at 27°C

01.111



NABL

Calibrated at 27°C

N-112

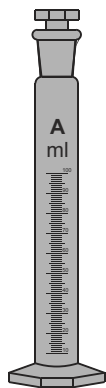

Calibrated at 27°C

01.113



NABL

Calibrated at 27°C

N-114

01.111 Measuring Cylinders, "RELIGLAS", with interchangeable stopper, Hexagonal Base, Class 'A' with calibration certificate. With AMBER stain graduation.

Cat. No.	Capacity (ml)	Sub. Div. (ml)	Tolerance ( $\pm$ ml)	Price / Piece Rs.
01.111.01	5	0.1	0.05	400.00
01.111.03	10	0.2	0.1	420.00
01.111.05	25	0.5	0.25	460.00
01.111.07	50	1	0.5	600.00
01.111.09	100	1	0.5	720.00
01.111.11	250	2	1	1150.00
01.111.13	500	5	2.5	1825.00
01.111.15	1000	10	5	2100.00
01.111.17	2000	20	10	3300.00

N-112 Measuring Cylinders, "RELIGLAS", with interchangeable stopper, Hexagonal Base, Class 'A' with NABL Certificate. With AMBER stain graduation.

NABL

Cat. No.	Capacity (ml)	Sub. Div. (ml)	Tolerance ( $\pm$ ml)	Price / Piece Rs.
N-112.01	5	0.1	0.05	715.00
N-112.03	10	0.2	0.1	725.00
N-112.05	25	0.5	0.25	750.00
N-112.07	50	1	0.5	850.00
N-112.09	100	1	0.5	900.00
N-112.11	250	2	1	1250.00
N-112.13	500	5	2.5	1900.00
N-112.15	1000	10	5	2250.00
N-112.17	2000	20	10	3450.00

01.113 Measuring Cylinders, "RELIGLAS", AMBER, with interchangeable stopper Hexagonal Base, Class 'A' with calibration certificate.

Cat. No.	Capacity (ml)	Sub. Div. (ml)	Tolerance ( $\pm$ ml)	Price / Piece Rs.
01.113.01	5	0.1	0.05	520.00
01.113.03	10	0.2	0.1	535.00
01.113.05	25	0.5	0.25	575.00
01.113.07	50	1	0.5	750.00
01.113.09	100	1	0.5	880.00
01.113.11	250	2	1	1345.00
01.113.13	500	5	2.5	2100.00
01.113.15	1000	10	5	2860.00
01.113.17	2000	20	10	4320.00

N-114 Measuring Cylinders, "RELIGLAS", AMBER, with interchangeable stopper Hexagonal Base, Class 'A' with NABL Certificate. With AMBER stain graduation.

NABL

Cat. No.	Capacity (ml)	Sub. Div. (ml)	Tolerance ( $\pm$ ml)	Price / Piece Rs.
N-114.01	5	0.1	0.05	820.00
N-114.03	10	0.2	0.1	840.00
N-114.05	25	0.5	0.25	875.00
N-114.07	50	1	0.5	1040.00
N-114.09	100	1	0.5	1180.00
N-114.11	250	2	1	1630.00
N-114.13	500	5	2.5	2380.00
N-114.15	1000	10	5	3140.00
N-114.17	2000	20	10	3700.00

01.115 Measuring Cylinders, "RELIGLAS", with interchangeable stopper, Hexagonal Base, accuracy as per ISO 4788/ IS 878:2008, Class 'B'.

Cat. No.	Capacity (ml)	Sub. Div. (ml)	Tolerance ( $\pm$ ml)	Price / Piece Rs.
01.115.01	5	0.1	0.1	280.00
01.115.03	10	0.2	0.2	300.00
01.115.05	25	0.5	0.5	310.00
01.115.07	50	1	1	375.00
01.115.09	100	1	1	450.00
01.115.11	250	2	2	760.00
01.115.13	500	5	5	1060.00
01.115.15	1000	10	10	1550.00
01.115.17	2000	20	20	2500.00

01.119 Measuring Cylinders, "RELIGLAS", with spout, Round Base, Class 'A', with calibration certificate. With AMBER stain graduation.

Cat. No.	Capacity (ml)	Sub. Div. (ml)	Tolerance ( $\pm$ ml)	Price / Piece Rs.
01.119.01	5	0.1	0.05	180.00
01.119.03	10	0.2	0.1	190.00
01.119.05	25	0.5	0.25	230.00
01.119.07	50	1	0.5	310.00
01.119.09	100	1	0.5	350.00
01.119.11	250	2	1	650.00
01.119.13	500	5	2.5	1080.00
01.119.15	1000	10	5	1290.00
01.119.17	2000	20	10	2050.00

N-120 Measuring Cylinders, "RELIGLAS", with spout, Round Base, Class 'A', with calibration certificate. With AMBER stain graduation.



Cat. No.	Capacity (ml)	Sub. Div. (ml)	Tolerance ( $\pm$ ml)	Price / Piece Rs.
N-120.01	5	0.1	0.05	380.00
N-120.03	10	0.2	0.1	380.00
N-120.05	25	0.5	0.25	410.00
N-120.07	50	1	0.5	490.00
N-120.09	100	1	0.5	550.00
N-120.11	250	2	1	835.00
N-120.13	500	5	2.5	1385.00
N-120.15	1000	10	5	1590.00
N-120.17	2000	20	10	2480.00

01.121 Measuring Cylinders, "RELIGLAS", with spout, Round Base, Thick Wall, accuracy as per ISO 4788/ IS 878:2008, Class 'B'.

Cat. No.	Capacity (ml)	Sub. Div. (ml)	Tolerance ( $\pm$ ml)	Price / Piece Rs.
01.121.01	5	0.1	0.1	120.00
01.121.03	10	0.2	0.2	130.00
01.121.05	25	0.5	0.5	174.00
01.121.07	50	1	1	190.00
01.121.09	100	1	1	240.00
01.121.11	250	2	2	460.00
01.121.13	500	5	5	650.00
01.121.15	1000	10	10	1050.00
01.121.17	2000	20	20	1820.00

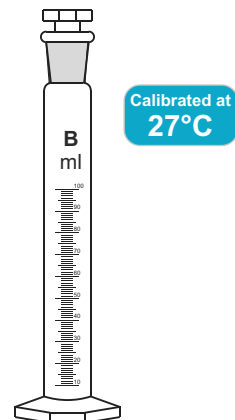

01.115

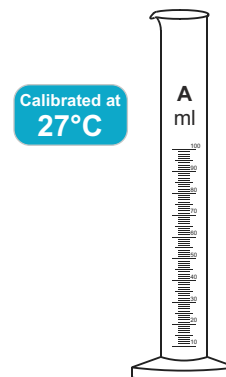

01.119

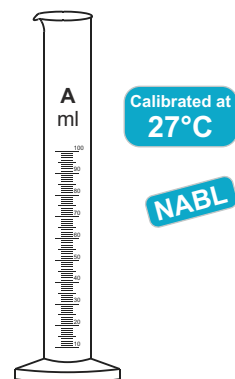

N-120

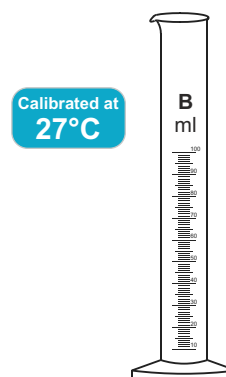

01.121

Volumetric / Graduated Glassware

Volumetric / Graduated Glassware

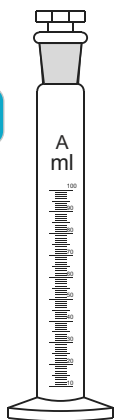

Calibrated at 27°C

01.125

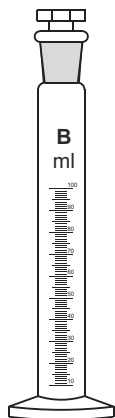

Calibrated at 27°C

01.127

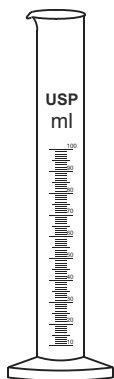

01.129

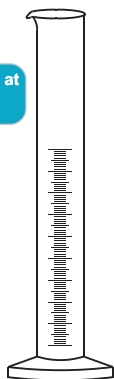

Calibrated at 27°C

01.130



Calibrated at 27°C

01.131

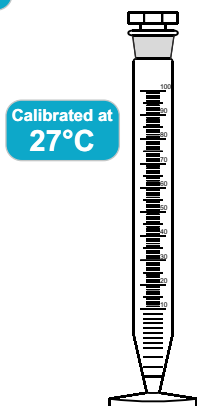

Calibrated at 27°C

01.132

01.125 Measuring Cylinders, "RELIGLAS", with interchangeable stopper, Round Base, Class 'A' with Calibration Certificate. With AMBER stain graduation.

Cat. No.	Capacity (ml)	Sub. Div. (ml)	Tolerance ( $\pm$ ml)	Price / Piece Rs.
01.125.01	5	0.1	0.05	260.00
01.125.03	10	0.2	0.1	270.00
01.125.05	25	0.5	0.25	310.00
01.125.07	50	1	0.5	370.00
01.125.09	100	1	0.5	440.00
01.125.11	250	2	1.0	780.00
01.125.13	500	5	2.5	1420.00
01.125.15	1000	10	5	1600.00
01.125.17	2000	20	10	2310.00

01.127 Measuring Cylinders, "RELIGLAS", with interchangeable stopper, Round Base, accuracy as per ISO 4788/ IS 878:2008, Class 'B'.

Cat. No.	Capacity (ml)	Sub. Div. (ml)	Tolerance ( $\pm$ ml)	Price / Piece Rs.
01.127.01	5	0.1	0.1	180.00
01.127.03	10	0.2	0.2	185.00
01.127.05	25	0.5	0.5	240.00
01.127.07	50	1	1	290.00
01.127.09	100	1	1	360.00
01.127.11	250	2	2	630.00
01.127.13	500	5	5	940.00
01.127.15	1000	10	10	1275.00
01.127.17	2000	20	20	2250.00

01.129 Bulk Density Cylinder, 'RELIGLAS', As per USP, Ch.616.

Cat. No.	Capacity (ml)	Price / Piece Rs.
01.129.01	100	740.00
01.129.03	250	950.00

01.130 Cylinder, Rain Measure as per IS 4849-1992, 20mm rain.

Cat. No.	Collector Area	Price / Piece Rs.
01.130.01	100 cm <sup>2</sup>	650.00
01.130.03	200 cm <sup>2</sup>	750.00

01.131 Crow Receiver, "RELIGLAS", with Round Base.

Cat. No.	Capacity (ml)	Class	Tolerance ( $\pm$ ml)	Price / Piece Rs.
01.131.01	25	Class 'B'	0.08 & 0.2	285.00
01.131.03	50	Class 'B'	0.2 & 0.4	350.00
01.131.05	100	Class 'B'	0.4 & 0.8	460.00
01.131.11	25	Class 'A'	0.04 & 0.1	360.00
01.131.15	50	Class 'A'	0.1 & 0.2	460.00
01.131.17	100	Class 'A'	0.2 & 0.4	560.00

01.132 Crow Receiver, "RELIGLAS", with interchangeable stopper and Round Base

Cat. No.	Capacity (ml)	Class	Tolerance ( $\pm$ ml)	Price / Piece Rs.
01.132.01	25	Class 'B'	0.08 & 0.2	360.00
01.132.03	50	Class 'B'	0.2 & 0.4	400.00
01.132.05	100	Class 'B'	0.4 & 0.8	525.00
01.132.11	25	Class 'A'	0.04 & 0.1	480.00
01.132.15	50	Class 'A'	0.1 & 0.2	595.00
01.132.17	100	Class 'A'	0.2 & 0.4	700.00
N-132.17	100	NABL	0.2 & 0.4	840.00

01.135 Nessler Cylinder, "RELIGLAS", for colour comparison graduated as per IS 4161 : 1967.

Cat. No.	Capacity (ml)	Sub. Div. (ml)	Tolerance ( $\pm$ ml)	Price / Piece Rs.
01.135.01	50	25 & 50	0.4	120.00
01.135.03	100	50 & 100	0.8	150.00

A-135 Nessler Cylinder, "RELIGLAS", for colour comparison graduated as per IS 4161 : 1967. A for Class 'A' Certificate and N for NABL Certificate.

Cat. No.	Capacity (ml)	Sub. Div. (ml)	Tolerance ( $\pm$ ml)	Price / Piece Rs.
A-135.11	50	25 & 50	0.2	210.00
A-135.13	100	50 & 100	0.4	270.00
N-135.11	50	25 & 50	0.2	400.00
N-135.13	100	50 & 100	0.4	475.00

01.136 Nessler Cylinder, "RELIGLAS", with Interchangeable Stopper, for colour comparison graduated as per IS 4161 : 1967.

Cat. No.	Capacity (ml)	Sub. Div. (ml)	Tolerance ( $\pm$ ml)	Price / Piece Rs.
01.136.01	50	25 & 50	0.4	250.00
01.136.03	100	50 & 100	0.8	330.00

01.137 Test Jar (Pour Point Tube), "RELIGLAS" Flat Bottom, Inside Dia 160.00  
30 to 34mm, Height 115 to 12mm, marked with line  $54 \pm 3$ mm.

01.138.01 Cones, Imhoff, Sedimentation, "RELIGLAS", 1000ml Graduated 3800.00

01.138.03 Cones, Imhoff, Sedimentation, "RELIGLAS", with bottom outlet, 4200.00  
1000ml, Graduated

01.138.05 Stand for Cones, Imhoff 3000.00

## TUBES

02.141 Tubes, Culture, Media, "RELIGLAS", Round Bottom, with Screw Cap, PTFE liner.

Cat. No.	Capacity (ml) approx.	O.D. x Length (mm) approx.	Price / Piece Rs.
02.141.05	5	16 x 75	33.00
02.141.10	7.5	16 x 100	36.00
02.141.15	10	16 x 125	38.00
02.141.20	15	16 x 150	42.00
02.141.25	25	18 x 150	45.00
02.141.30	30	25 x 100	50.00
02.141.35	45	25 x 150	54.00
02.141.40	60	25 x 200	60.00
02.141.45	100	32 x 200	138.00
02.141.50	150	38 x 200	215.00

02.142 Tubes Culture, Media, AMBER "RELIGLAS", Round Bottom, with Screw Cap and PTFE Liner.

Cat. No.	Capacity (ml) approx.	O.D. x Length (mm) approx.	Price / Piece Rs.
02.142.05	5	16 x 75	60.00
02.142.15	10	16 x 125	75.00
02.142.30	30	25 x 100	100.00
02.142.35	45	25 x 150	120.00
02.142.40	60	25 x 200	148.00
02.142.45	100	32 x 200	240.00
02.142.50	150	38 x 200	340.00

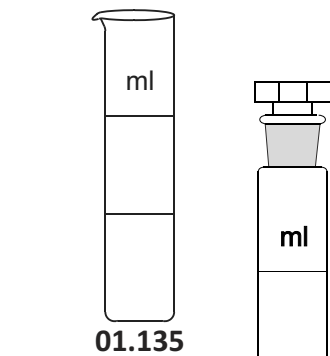

A.135/N.135

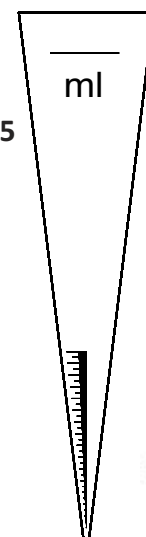

01.138



01.038.05

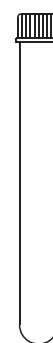

02.141



02.142



02.143

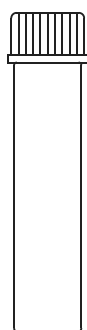

02.145

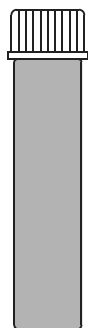

02.146

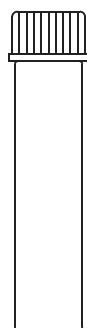

02.147

**02.143 Tubes, Culture, Media, "RELI GLAS", Round Bottom, with Screw Cap & Rubber liner.**

Cat. No.	Capacity (ml) approx.	O.D. x Length (mm) approx.	Price / Piece Rs.
02.143.05	5	16 x 75	22.00
02.143.10	7.5	16 x 100	23.00
02.143.15	10	16 x 125	25.00
02.143.20	15	16 x 150	28.00
02.143.25	25	18 x 150	33.00
02.143.30	30	25 x 100	35.00
02.143.35	45	25 x 150	38.00
02.143.40	60	25 x 200	42.00
02.143.45	100	32 x 200	105.00
02.143.50	150	38 x 200	198.00

**02.145 Tubes Culture, Media, "RELI GLAS", Flat Bottom, with Screw Cap, PTFE liner.**

Cat. No.	Capacity (ml) approx.	O.D. x Length (mm) approx.	Price / Piece Rs.
02.145.05	5	16 x 50	30.00
02.145.06	7.5	16 x 95	32.00
02.145.07	10	16 x 120	33.00
02.145.08	15	16 x 145	37.00
02.145.09	25	18 x 145	44.00
02.145.10	15	25 x 57	42.00
02.145.11	10	25 x 50	39.00
02.145.12	20	25 x 75	39.00
02.145.15	30	25 x 95	48.00
02.145.17	40	25 x 145	60.00

**02.146 Tubes Culture, Media, "RELI GLAS", AMBER, Flat Bottom, with Screw Cap, PTFE liner.**

Cat. No.	Capacity (ml) approx.	O.D. x Length (mm) approx.	Price / Piece Rs.
02.146.04	5	18 x 45	60.00
02.146.05	5	16 x 50	60.00
02.146.06	7.5	16 x 95	66.00
02.146.07	10	16 x 120	75.00
02.146.08	15	16 x 145	82.00
02.146.09	25	18 x 145	88.00
02.146.10	15	25 x 57	82.00
02.146.11	10	25 x 50	80.00
02.146.12	20	25 x 75	84.00
02.146.15	30	25 x 95	100.00
02.146.17	40	25 x 145	120.00

**02.147 Tubes, Culture, Media, "RELI GLAS", Flat Bottom, with Screw Cap and Rubber liner.**

Cat. No.	Capacity (ml) approx.	O.D. x Length (mm) approx.	Price / Piece Rs.
02.147.05	5	16 x 50	21.00
02.147.06	7.5	16 x 95	24.00
02.147.07	10	16 x 120	27.00
02.147.08	15	16 x 145	30.00
02.147.09	25	18 x 145	38.00
02.147.10	15	25 x 57	26.00
02.147.11	10	25 x 50	25.00
02.147.12	20	25 x 75	28.00
02.147.15	30	25 x 95	34.00
02.147.17	40	25 x 145	40.00

02.151 Centrifuge Tube, "RELIGLAS", Conical bottom, graduated.

Cat. No.	Capacity (ml)	Height x O.D. (mm) approx.	Price / Piece Rs.
02.151.04	5	100x13	62.00
02.151.05	10	110x15	68.00
02.151.10	15	120x17	72.00
02.151.12	25	125x22	110.00
02.151.15	50	125x28	145.00
02.151.16	50ml, Graduated	Solubility Tube	260.00

02.153 Centrifuge Tube, "RELIGLAS", Conical bottom, plain.

Cat. No.	Capacity (ml)	Height x O.D. (mm) approx.	Price / Piece Rs.
02.153.04	5	100x13	28.00
02.153.05	10	110x15	32.00
02.153.10	12	110x16	34.00
02.153.15	15	120x17	35.00
02.153.18	25	125x22	90.00
02.153.20	50	125x28	120.00

02.155 Centrifuge Tube, "RELIGLAS", with Screw Cap, Plain.

Cat. No.	Capacity (ml) approx.	Price / Piece Rs.
02.155.05	10	77.00
02.155.10	15	79.00
02.155.20	50	154.00

02.157 Centrifuge Tube, "RELIGLAS", with Screw Cap, Graduated.

Cat. No.	Capacity (ml) approx.	Price / Piece Rs.
02.157.05	10	115.00
02.157.10	15	120.00
02.157.20	50	250.00

02.161 Centrifuge Tube, "RELIGLAS", Conical bottom, with l/c stopper, Graduated.

Cat. No.	Capacity (ml)	Price / Piece Rs.
02.161.04	5	105.00
02.161.05	10	110.00
02.161.10	15	120.00
02.161.12	25	180.00
02.161.15	50	240.00

02.163 Centrifuge Tube, "RELIGLAS", Conical Bottom, with l/c stopper, Plain.

Cat. No.	Capacity (ml)	Price / Piece Rs.
02.163.04	5	85.00
02.163.05	10	94.00
02.163.10	15	99.00
02.163.12	25	140.00
02.163.15	50	198.00

02.165 Oil Centrifuge Cylindrical, 100 ml, as per ASTM D-96 600.00

N.165 Oil Centrifuge Cylindrical, 100ml, with NABL Certificate 900.00

02.166 Oil Centrifuge Pear Shape, 100 ml, as per ASTM D-96 700.00

N.166 Oil Centrifuge Pear Shape, 100 ml, with NABL Certificate 1000.00

02.171 Test Tubes, "RELIGLAS", with interchangeable stopper, Graduated.

Cat. No.	Length x O.D. (mm approx)	Capacity (ml)	Sub Div. (ml)	Stopper Size	Price/Piece Rs.
02.171.05	100 x 13	5	0.1	10/19	105.00
02.171.10	125 x 15	10	0.1	14/23	115.00
02.171.11	150 x 15	15	0.1	14/23	125.00
02.171.12	150 x 18	20	0.1	14/23	140.00
02.171.15	150 x 22	25	0.5	19/26	150.00
02.171.16	150 x 25	30	0.5	19/26	160.00
02.171.20	200 x 25	50	1	19/26	180.00
02.171.25	230 x 32	100	2	24/29	260.00



02.151



02.153



02.155



02.157



02.161

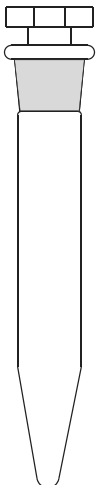

02.163

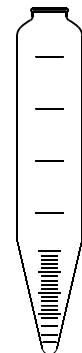

02.165

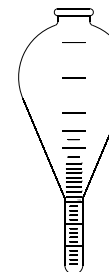

02.166

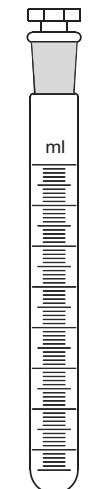

02.171



Tubes



02.171A



02.173

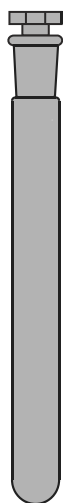

02.173A

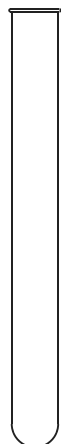

02.175

02.171A Test Tubes, "RELIGLAS", AMBER with interchangeable stopper, Graduated.

Cat. No.	Length x O.D. (mm approx)	Capacity (ml)	Sub Div. (ml)	Stopper Size	Price/Piece Rs.
02.171A.01	100 x 13	5	0.1	10/19	140.00
02.171A.03	125 x 15	10	0.1	12/21	152.00
02.171A.05	150 x 18	20	0.1	14/23	165.00
02.171A.07	150 x 25	25	0.5	19/26	184.00
02.171A.09	200 x 25	50	0.5	19/26	210.00
02.171A.11	200 x 32	100	1	24/29	260.00
02.171A.13	230 x 38	150	2	24/29	320.00

02.173 Test Tubes, "RELIGLAS", with Interchangeable Stopper, Plain.

Cat. No.	Length x OD. (mm) approx.	Capacity (ml) approx.	Stopper Size	Price / Piece Rs.
02.173.05	100x13	5	10/19	69.00
02.173.10	125x15	10	12/21	79.00
02.173.11	150x15	15	12/21	87.00
02.173.15	150x18	20	14/23	94.00
02.173.20	150x22	25	19/26	112.00
02.173.25	150x25	30	19/26	118.00
02.173.27	175x25	40	19/26	128.00
02.173.30	200x25	50	19/26	138.00
02.173.35	200x32	75	24/29	190.00
02.173.36	230x32	100	24/29	198.00
02.173.40	230x38	150	24/29	210.00

02.173A Test Tubes, "RELIGLAS", with Interchangeable Stopper, Plain. AMBER.

Cat. No.	Length x O.D. (mm approx)	Capacity (ml)	Sub Div. (ml)	Stopper Size	Price/Piece Rs.
02.171A.01	100 x 13	5	0.1	10/19	118.00
02.171A.03	125 x 15	10	0.1	12/21	125.00
02.171A.05	150 x 18	20	0.1	14/23	138.00
02.171A.07	150 x 25	25	0.5	19/26	165.00
02.171A.09	200 x 25	50	0.5	19/26	185.00
02.171A.11	200 x 32	100	1	24/29	230.00
02.171A.13	230 x 38	150	2	24/29	275.00

02.175 Test Tubes, "RELIGLAS", Boro 33 exp. glass, Round Bottom, with rim, Plain.

Cat. No.	Capacity (ml) approx.	O.D. x Length (mm) approx.	Qty / Pack	Price / Piece Rs.
02.175.05	3	10x75	100	6.00
02.175.10	5	12x75	100	6.60
02.175.15	8	12x100	100	8.20
02.175.16	4	13x55	100	8.80
02.175.20	10	15x125	100	11.00
02.175.25	15	15x150	100	13.50
02.175.30	25	18x150	100	15.00
02.175.35	35	25x100	50	18.50
02.175.40	50	25x150	50	21.00
02.175.45	75	25x200	50	30.00
02.175.50	100	32x200	25	48.00
02.175.55	150	38x200	25	68.00

02.177 Test Tubes, "RELIGLAS", Boro 33exp. glass, Round bottom, rimless, Plain.

Cat. No.	Capacity (ml) approx.	O.D. x Length (mm) approx.	Qty / Pack	Price / Piece Rs.
02.177.03	1	7x60	100	6.50
02.177.04	2	7x125	100	8.00
02.177.05	3	10x75	100	6.00
02.177.10	5	12x75	100	6.60
02.177.15	7	12x100	100	8.20
02.177.16	8	12x125	100	9.00
02.177.18	12	16x100	100	12.00
02.177.20	10	15x125	100	11.00
02.177.25	15	15x150	100	13.50
02.177.26	20	16x150	100	15.00
02.177.28	25	18x125	100	16.00
02.177.30	27	18x150	100	15.00
02.177.35	35	25x100	50	18.50
02.177.40	50	25x150	50	21.00
02.177.45	75	25x200	50	30.00
02.177.50	100	32x200	25	48.00
02.177.55	150	38x200	25	68.00



02.177

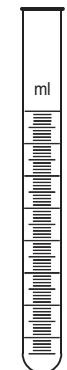

02.179



02.184

02.179 Test Tubes, "RELIGLAS", Boro 33exp. glass, Round bottom, with rim, Graduated, Graduation in AMBER.

Cat. No.	Capacity (ml)	O.D. x Length (mm) approx.	Qty / Pack	Price / Piece Rs.
02.179.05	3	10x75	10	33.00
02.179.10	5	12x75	10	35.00
02.179.15	8	12x100	10	40.00
02.179.25	10	15x125	10	44.00
02.179.35	25	18x150	10	60.00
02.179.40	50	25x150	10	70.00
02.179.45	75	25x200	10	80.00



02.187



02.188

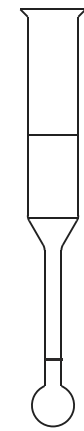

02.189

02.184 Tubes Funnel Test Tubes.

Cat. No.	Capacity (ml)	Price/Piece (Rs.)
02.184.15	15	80.00
02.184.30	30	99.00

02.187 Tubes, Kjeldahl Digestion, "RELIGLAS", with constriction on top.

Cat. No.	O.D. x L (mm) approx.	Price / Piece (Rs.)
02.187.01	24 x 250	200.00
02.187.03	26 x 250	210.00
02.187.05	40 x 300	320.00

02.188 Tubes, Kjeldahl Digestion, "RELIGLAS", with plain collar with rim.

Cat. No.	O.D. x L (mm) approx.	Price / Piece (Rs.)
02.188.01	26 x 300	180.00
02.188.03	40 x 300	280.00
02.188.05	42 x 300	300.00

02.189 Blood Sugar Tubes, "RELIGLAS", Folin Wu, as per ISO/IS 3740:1966, Capacity 25 ml, marked at 4, 12.5 and 25 ml. 100.00

02.191 Wintrobe Tubes, "RELIGLAS", 100 mm. graduated. 35.00

02.193 Durham Tube, "RELIGLAS"

Cat. No.	Size (mm) approx.	Qty / Pack	Price/Pack (Rs.)
02.193.01	25 x 6	100	460.00
02.193.03	37 x 6	100	500.00
02.193.05	50 x 6	100	600.00



02.191

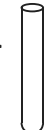

02.193

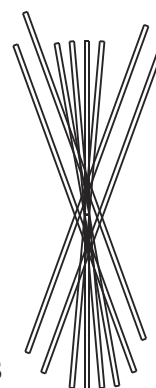

02.195



02.196

02.195.01 Melting Point Capillary, both ends open, 100mm, 100/vial 98.00

02.195.02 Melting point Capillary, both ends open, 75mm, 100/vial 66.00

02.195.04 Melting point Capillary, one end sealed, 75mm, 100/vial 72.00

02.196 Drosiphila Tube 20.00

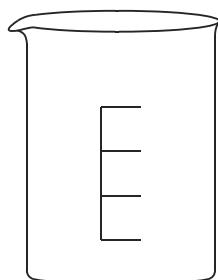

02.201

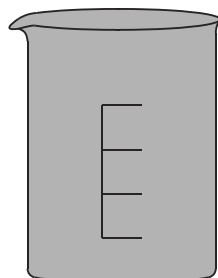

02.202

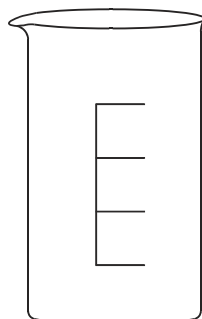

02.203

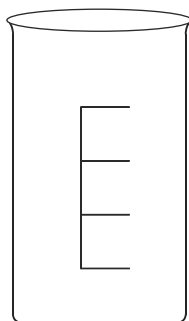

02.205

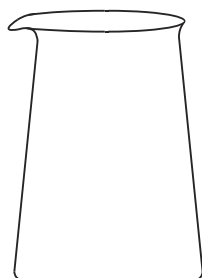

02.209

## BEAKERS

02.201 Beakers Low form, "RELIGLAS", with spout, Approx. graduation  $\pm 5\%$  accuracy. Complies with IS 2619/ISO 3819 & DIN 12331.

Cat. No.	Capacity (ml)	Dim. approx. Dia. x Ht. (mm)	Price / Piece Rs.
02.201.01	*5	22 x 30	48.00
02.201.03	*10	26 x 35	50.00
02.201.05	25	34 x 51	52.00
02.201.07	50	42 x 58	55.00
02.201.09	100	50 x 70	60.00
02.201.11	150	60 x 88	70.00
02.201.13	250	68 x 95	94.00
02.201.15	400	80 x 110	140.00
02.201.17	500	83 x 118	140.00
02.201.19	600	90 x 125	190.00
02.201.21	800	105 x 138	295.00
02.201.23	1000	105 x 162	295.00
02.201.25	2000	132 x 185	685.00
02.201.27	3000	152 x 210	1450.00
02.201.29	5000	170 x 270	2250.00
02.201.31	100000	220 x 350	6400.00

Note: \*Not Graduated. Double Graduation @ 5% extra cost.  
5000ml & 10000ml Beakers not covered in IS/ ISO or DIN Standards.

02.202 Beakers Low form, "RELIGLAS", AMBER, with spout, Approx. grad.  $\pm 5\%$  acc.

Cat. No.	Capacity (ml)	Price / Piece Rs.
02.202.05	25	120.00
02.202.07	50	150.00
02.202.09	100	210.00
02.202.11	150	230.00
02.202.13	250	265.00
02.202.17	500	400.00
02.202.23	1000	825.00
02.202.25	2000	1600.00

02.203 Beakers Tall form, "RELIGLAS", with spout, graduation  $\pm 5\%$  accuracy. Complies with IS 2619/ISO 3819 & DIN 12331.

Cat. No.	Capacity (ml)	Dim. approx. Dia. x Ht. (mm)	Price / Piece Rs.
02.203.01	50	38 x 70	100.00
02.203.03	100	48 x 80	120.00
02.203.05	150	54 x 95	130.00
02.203.07	250	60 x 120	140.00
02.203.09	500	70 x 130	200.00
02.203.10	800	80 x 150	325.00
02.203.11	1000	90 x 192	400.00

02.205 Beakers Tall form, "RELIGLAS", without spout, graduation  $\pm 5\%$  accuracy. Complies with IS 2619/ISO 3819 & DIN 12331.

Cat. No.	Capacity (ml)	Price / Piece Rs.
02.205.01	50	100.00
02.205.03	100	120.00
02.205.05	150	130.00
02.205.07	250	140.00
02.205.09	500	200.00
02.205.10	800	325.00
02.205.11	1000	400.00

02.209 Beakers, Conical Shape, "RELIGLAS" (Phillips Pattern) with spout.

Cat. No.	Capacity (ml)	Price / Piece (Rs.)
02.209.01	250	420.00
02.209.03	500	540.00

02.210 Beaker Tablet Disintegration, as per B.P. 1000 ml, OD x Ht. (mm) 105 x 145, spoutless. 360.00

**BOTTLES**

02.215 Reagent Bottles, "RELIGLAS", Narrow Mouth, with interchangeable Stopper. Complies with IS 1388-2, ISO/DIN 4796-2

Cat. No.	Capacity (ml)	Dim. approx. Dia. x Ht. (mm)	Stopper Size	Price / Piece Rs.
02.215.01	25/30*	35 x 80	14/23	185.00
02.215.03	50/60*	45 x 90	14/23	225.00
02.215.05	100/125*	55 x 120	19/26	300.00
02.215.09	250	70 x 128	19/26	350.00
02.215.11	500	86 x 162	24/29	430.00
02.215.13	1000	107 x 198	29/32	620.00
02.215.15	2000	133 x 246	34/35	1150.00
02.215.17	3000*	158 x 260	45/40	2500.00
02.215.19	5000*	183 x 320	45/40	6500.00
02.215.21	10000*	235 x 430	45/40	10000.00

\* Not covered in any standard

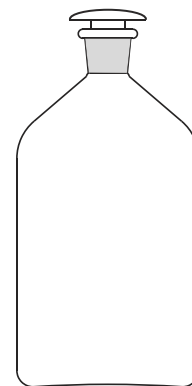

02.215

02.217 Reagent Bottles, 'RELIGLAS', AMBER, Narrow Mouth, with interchangeable Stopper. Complies with IS 1388-2, ISO/DIN 4796-2

Cat. No.	Capacity (ml)	Dim. approx. Dia. x Ht. (mm)	Stopper Size	Price / Piece Rs.
02.217.01	25/30*	35 x 80	14/23	320.00
02.217.03	50/60*	45 x 90	14/23	425.00
02.217.05	100/125*	55 x 120	19/26	460.00
02.217.09	250	70 x 128	19/26	580.00
02.217.11	500	86 x 162	24/29	710.00
02.217.13	1000	107 x 198	29/32	1070.00
02.217.15	2000	133 x 246	34/35	1850.00
02.217.17	3000*	158 x 260	45/40	7200.00
02.217.19	5000*	183 x 320	45/40	11000.00

\* Not covered in any standard

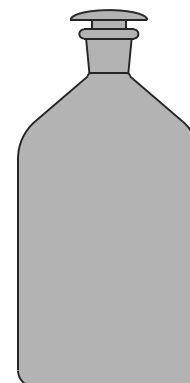

02.217

02.221 Reagent Bottle "RELIGLAS", Clear, wide mouth with Polypropylene Blue screw cap and pouring ring, autoclavable, Graduated. IS 1388-1, ISO/DIN 4796-1

Cat. No.	Capacity (ml)	Dim. approx. Dia. x Ht. (mm)	DIN Thread Size	Price / Piece Rs.
02.221.25	10*	36 x 50	GI-25	220.00
02.221.01	25	36 x 70	GI-25	240.00
02.221.03	50	46 x 87	GI-32	275.00
02.221.05	100	56 x 100	GI-45	310.00
02.221.06	150*	60 x 120	GI-45	315.00
02.221.07	250	70 x 138	GI-45	320.00
02.221.09	500	86 x 176	GI-45	360.00
02.221.11	1000	100 x 225	GI-45	590.00
02.221.13	2000	136 x 260	GI-45	975.00
02.221.15	3000*	158 x 295	GI-45	4200.00
02.221.17	5000	181 x 330	GI-45	5250.00
02.221.19	10000	227 x 410	GI-45	8900.00
02.221.21	20000	288 x 505	GI-45	15700.00

\* Not covered in any standard

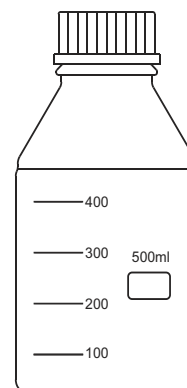

02.221

02.223 Reagent Bottle "RELIGLAS", AMBER, wide mouth with Polypropylene Blue screw cap and pouring ring, autoclavable, graduated. IS 1388-1, ISO/DIN 4796-1

Cat. No.	Capacity (ml)	Dim. approx. Dia. x Ht. (mm)	DIN Thread Size	Price / Piece Rs.
02.223.25	10*	36 x 50	GL-25	300.00
02.223.01	25	36 x 70	GL-25	350.00
02.223.03	50	46 x 87	GL-32	395.00
02.223.05	100	56 x 100	GL-45	470.00
02.223.06	150*	60 x 120	GL-45	515.00
02.223.07	250	70 x 138	GL-45	520.00
02.223.09	500	86 x 176	GL-45	610.00
02.223.11	1000	100 x 225	GL-45	815.00
02.223.13	2000	136 x 260	GL-45	1540.00
02.223.15	3000*	158 x 295	GL-45	8100.00
02.223.17	5000	181 x 330	GL-45	8400.00
02.223.19	10000	227 x 410	GL-45	12000.00
02.223.21	20000	288 x 505	GL-45	18000.00

\* Not covered in any standard

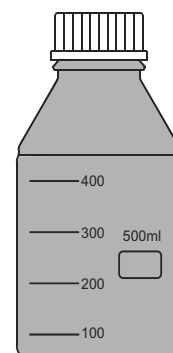

02.223



02.224

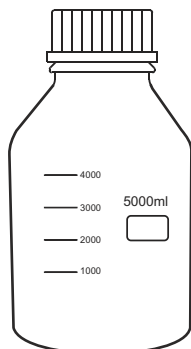

02.225

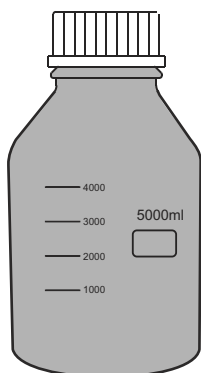

02.227

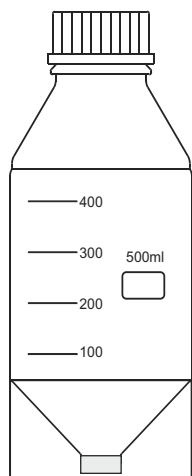

02.229



02.230

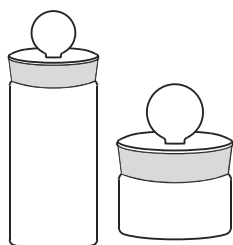

02.231

02.224 Screw Caps, Polypropylene, Autoclavable

Cat. No.	DIN Thread Size	Colour	Price / Piece Rs.
02.224.05	GL-25	Blue	49.00
02.224.10	GL-32	Blue	52.00
02.224.15	GL-45	Blue	56.00
02.224.16	GL-45	Orange	65.00
02.224.17	GL-45	Yellow	65.00
02.224.18	GL-45	Green	65.00
02.224.19	GL-45	Grey	65.00
02.224.20	GL-45	White	65.00
02.224.30	Pouring Ring for GL-45		15.00

02.225 Reagent Bottle "RELIGLAS", Clear, extra wide mouth with Polypropylene Blue screw cap and pouring ring, repeatedly autoclavable, Graduated.

Cat. No.	Capacity (ml)	DIN Thread Size	Price / Piece Rs.
02.225.01	5000	GL-80	6600.00
02.225.03	10000	GL-80	11200.00
02.225.05	20000	GL-80	21800.00

02.227 Reagent Bottle "RELIGLAS", AMBER, extra wide mouth with Polypropylene Blue screw cap & pouring ring, repeatedly autoclavable, Graduated

Cat. No.	Capacity (ml)	DIN Thread Size	Price / Piece Rs.
02.227.01	5000	GL-80	9200.00
02.227.03	10000	GL-80	12800.00
02.227.05	20000	GL-80	26500.00

02.229 Bottle, HPLC Mobile Phase, "RELIGLAS", USP, PP Screw Cap.

Cat. No.	Capacity (ml) approx.	Price / Piece Rs.
02.229.01	500	1600.00
02.229.03	1000	2000.00
02.229.05	2000	3250.00
02.229.07	3000	6850.00
02.229.09	5000	9900.00

02.230 Glass Weighing Boat/ Scoop, "RELIGLAS"

Cat. No.	Capacity (ml) approx.	Price / Piece Rs.
02.230.01	1	160.00
02.230.03	2	160.00
02.230.05	3	170.00
02.230.07	6	200.00
02.230.09	10	210.00

02.231 Weighing Bottles, "RELIGLAS", with interchangeable stopper. IS 1574

Cat. No.	Type	O.D. x Ht. (mm) approx.	Capacity (ml) approx.	Price / Piece Rs.
02.231.01	Squat form	40 x 30	20	250.00
02.231.03	Squat form	50 x 25	20	320.00
02.231.05	Squat form	50 x 35	35	350.00
02.231.07	Squat form	50 x 50	50	360.00
02.231.09	Squat form	60 x 40	40	450.00
02.231.11	Tall form	20 x 40	5	130.00
02.231.13	Tall form	25 x 60	15	150.00
02.231.15	Tall form	30 x 65	25	190.00
02.231.17	Tall form	40 x 90	60	300.00

02.232 Weighing Bottles, "RELIGLAS", AMBER, with interchangeable stopper. IS 1574

Cat. No.	Type	O.D. x Ht. (mm) approx.	Capacity (ml) approx.	Price / Piece Rs.
02.232.01	Squat form	40 x 30	20	370.00
02.232.03	Squat form	50 x 25	20	450.00
02.232.05	Squat form	50 x 35	35	480.00
02.232.07	Squat form	50 x 50	50	500.00
02.232.09	Squat form	60 x 40	40	575.00
02.232.11	Tall form	20 x 40	5	220.00
02.232.13	Tall form	25 x 60	15	250.00
02.232.15	Tall form	30 x 65	25	320.00
02.232.17	Tall form	40 x 90	60	480.00

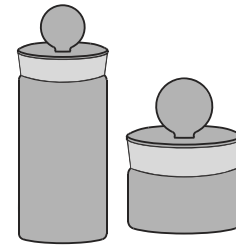

02.232

02.233 Specific Gravity Bottles, "RELIGLAS", Ground Standard neck with interchangeable PTFE stopper, Class 'A' with Calibration Certificate.

Cat. No.	Capacity (ml)	Tolerance (+ ml)	Price / Piece Rs.
02.233.01	10	0.3	380.00
02.233.03	25	0.8	450.00
02.233.05	50	1	480.00
02.233.10	100	2	600.00
02.233.15	5	0.1	370.00

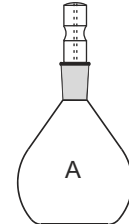

02.233

N-233 Specific Gravity Bottles, "RELIGLAS", Ground Standard neck with interchangeable PTFE stopper, Class 'A' with NABL Certificate.

Cat. No.	Capacity (ml)	Tolerance (+ ml)	Price / Piece Rs.
N-233.01	10	0.3	600.00
N-233.03	25	0.8	700.00
N-233.05	50	1	725.00
N-233.10	100	2	950.00
N-233.15	5	0.1	570.00

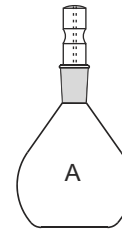

N-233

02.235 Specific Gravity Bottles, "RELIGLAS", Ground Capillary Stopper.

Cat. No.	Capacity (ml)	Tolerance (+ ml)	Price / Piece Rs.
02.235.01	10	0.6	200.00
02.235.03	25	1.6	220.00
02.235.05	50	2	240.00
02.235.10	100	4	280.00
02.235.15	5	0.6	200.00

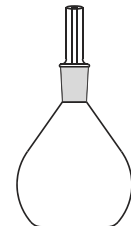

02.235

02.236 Specific Gravity Bottles, "RELIGLAS" with standard joint thermometer, range 0° to 50°C (Pyknometer).

Cat. No.	Capacity (ml)	Price / Piece Rs.
02.236.01	10	760.00
02.236.03	25	730.00
02.236.05	50	750.00

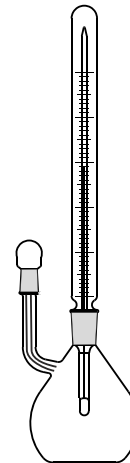

02.236

02.237 Specific Gravy Bottles, "RELIGLAS", Class 'A' with Calibration Certificate, with standard joint thermometer, range 0° to 50°C (Pyknometer).

Cat. No.	Capacity (ml)	Price / Piece Rs.
02.237.01	10	800.00
02.237.03	25	770.00
02.237.05	50	790.00

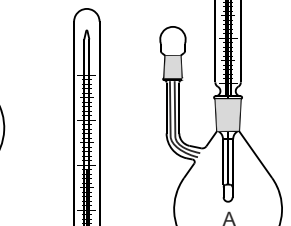

02.237

N-237 Specific Gravy Bottles, "RELIGLAS", Class 'A' with NABL Certificate, with standard joint thermometer, range 0° to 50°C (Pyknometer).

Cat. No.	Capacity (ml)	Price / Piece Rs.
N-237.01	10	950.00
N-237.03	25	975.00
N-237.05	50	1010.00

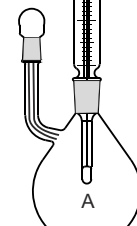

N-237

Bottles

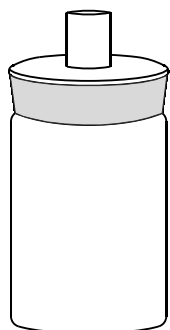

02.238

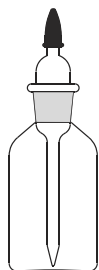

02.241

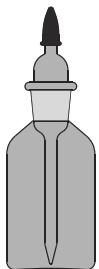

02.242

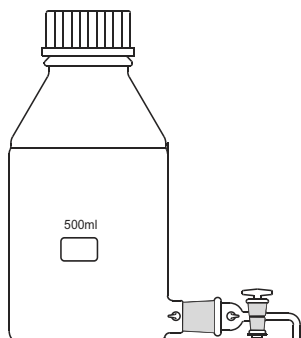

02.245

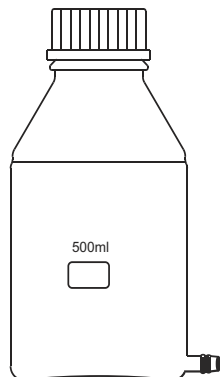

02.247

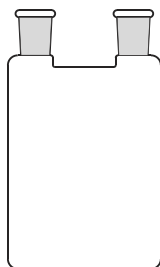

02.249



02.251

02.238 Bottles, Wide Mouth, 'RELIGLAS', with interchangeable stopper with tube for 15mm Suba Seal.

Cat. No.	Size (mm)	Capacity (ml)	Price / Piece Rs.
02.238.01	30 x 60	25	230.00
02.238.03	40 x 80	60	285.00
02.238.05	50 x 80	100	370.00
02.238.07	60 x 100	250	420.00
02.238.09	75 x 130	500	820.00
02.238.11	90 x 180	1000	1100.00

02.241 Bottles Dropping, "RELIGLAS", fitted with interchangeable joint dropping pipette and rubber test.

Cat. No.	Capacity (ml)	Price / Piece Rs.
02.241.01	25/30	250.00
02.241.03	50/60	280.00
02.241.05	100/125	375.00
02.241.07	250	490.00

02.242 Bottles Dropping, "RELIGLAS", AMBER, fitted with interchangeable joint dropping pipette and rubber test.

Cat. No.	Capacity (ml)	Price / Piece Rs.
02.242.01	25/30	400.00
02.242.03	50/60	500.00
02.242.05	100/125	550.00
02.242.07	250	700.00

02.245 Bottles Aspirator, "RELIGLAS", with I/C stopper or Screw Cap, stopcock with interchangeable joint.

Cat. No.	Capacity (ml) approx.	Price / Piece Rs.
02.245.01	1000	1950.00
02.245.03	2000	2320.00
02.245.05	3000	5400.00
02.245.07	5000	8200.00
02.245.09	10000	11500.00
02.245.11	20000	17500.00

02.247 Bottles Aspirator, "RELIGLAS", with Screw Cap and Outlet for Tubing.

Cat. No.	Capacity (ml) approx.	Price / Piece Rs.
02.247.01	250	380.00
02.247.03	500	480.00
02.247.05	1000	780.00
02.247.07	2000	1350.00

02.249 Woulf Bottles, "RELIGLAS", with two standard joint necks.

Cat. No.	Capacity (ml) approx.	Price / Piece Rs.
02.249.01	250	550.00
02.249.03	500	650.00
02.249.05	1000	980.00

02.251 Mac-Cartney Bottles, "RELIGLAS", Complete with Aluminum Cap and Rubber Liner.

Cat. No.	Capacity (ml) approx.	Minimum Qty/Pack	Price / Piece Rs.
02.251.01	5	25	36.00
02.251.03	15	25	46.00
02.251.05	30	25	60.00
02.251.07	60	25	96.00

02.255 Bottles, B.O.D. with interchangeable stopper "RELIGLAS". IS 9213

Cat. No.	Capacity (ml)	Approx. (mm) OD x Height	Price / Piece Rs.
02.255.05	60*	42 x 100	320.00
02.255.01	125*	55 x 120	370.00
02.255.03	300	70 x 143	460.00

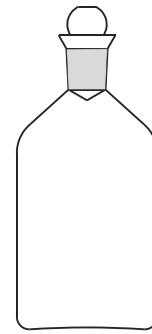

02.255

02.256 Bottles, B.O.D. , AMBER with interchangeable stopper "RELIGLAS".

Cat. No.	Capacity (ml)	Approx. (mm) OD x Height	Price / Piece Rs.
02.256.05	60*	42 x 100	450.00
02.256.01	125*	55 x 120	620.00
02.256.03	300	70 x 143	720.00

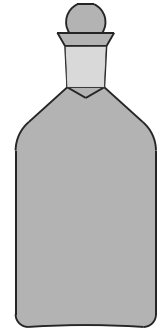

02.256

Note: \*60ml & 125ml not covered in standard.



DISHES

02.261 Petri Dishes, "RELIGLAS", Boro 33 Glass, repeatedly autoclavable.

Cat. No.	O.D. x Ht. (mm) approx.	Price / Piece Rs.
02.261.01	50x17	120.00
02.261.03	62x17	140.00
02.261.05	80x17	145.00
02.261.07	100x17	150.00
02.261.09	150 x20	525.00
02.261.11	200 x20	1220.00

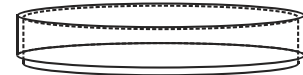

02.261

02.262 Petri Dishes, "RELIGLAS", Boro 33 Glass, AMBER, repeatedly autoclavable.

Cat. No.	O.D. x Height (mm) approx.	Price/Piece Rs.
02.262.01	50x17	300.00
02.262.05	80x17	360.00
02.262.07	100x17	430.00
02.262.09	150 x20	900.00
02.262.11	200x20	1600.00

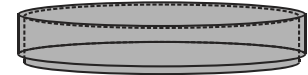

02.262

02.263 Dishes Crystallizing, "RELIGLAS", with / without Spout.

Cat. No.	O.D. x Ht. (mm) approx.	Capacity (ml) approx.	Price / Piece Rs.
02.263.01	40 x 25	20	90.00
02.263.03	50 x 30	40	115.00
02.263.05	60 x 35	60	140.00
02.263.07	70 x 40	100	198.00
02.263.09	80 x 45	150	260.00
02.263.11	100 x 50	300	375.00
02.263.13	115 x 65	500	600.00
02.263.15	150 x 75	1000	800.00
02.263.17	190 x 100	2000	1450.00

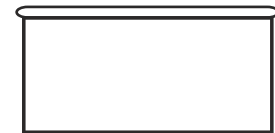

02.263

02.265 Dishes Evaporating, "RELIGLAS", Flat Bottom, with Spout.

Cat. No.	O.D. x Ht. (mm) approx.	Capacity (ml) approx.	Price / Piece Rs.
02.265.01	50 x 25	15	150.00
02.265.03	60 x 30	45	190.00
02.265.05	80 x 45	90	265.00
02.265.07	95 x 55	170	325.00
02.265.06	105 x 55	290	350.00
02.265.09	150 x 80	600	800.00
02.265.11	200 x 100	1500	1700.00



02.265



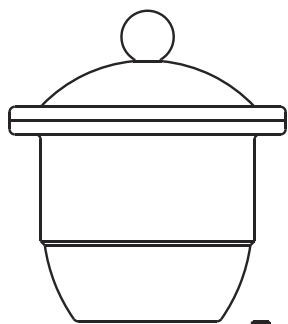

02.271

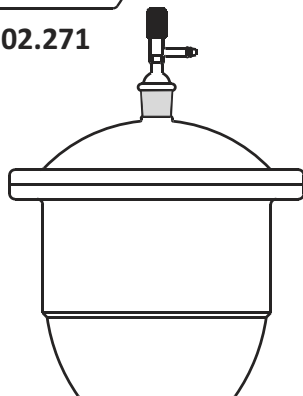

02.273

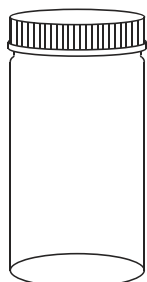

02.281

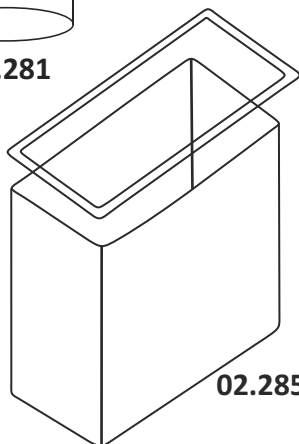

02.285

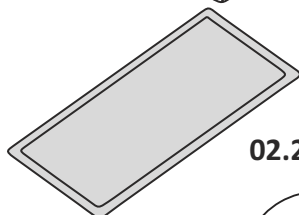

02.285A

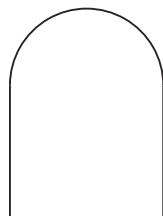

02.287

## DESICCATOR

02.271 Desiccators Plain with knobbed lid, Ground Flanges, Neutral Glass, supplied with Porcelain perforated plate.

Cat. No.	Dia (mm) approx.	Price / Piece Rs.
02.271.03	120	1400.00
02.271.05	160	1900.00
02.271.07	210	3100.00
02.271.09	240	4800.00
02.271.11	300	7200.00

02.273 Desiccators, Vacuum with tubular Lid, Ground Flanges, and stopcock, Neutral glass, supplied with perforated porcelain plate.

Cat. No.	Dia (mm) approx.	Price / Piece Rs.
02.273.05	160	2400.00
02.273.07	210	4500.00
02.273.09	240	7200.00
02.273.11	300	10250.00

## JARS

02.281 Culture Jars (Specimen), "RELIGLAS", with Polypropylene screw cap and Rubber liner, suitable for Culture, Autoclave able.

Cat. No.	O.D. x Ht. (mm) approx.	Capacity (mm) approx.	Price / Piece Rs.
02.281.01	50 x 75	100	240.00
02.281.03	60 x 110	250	320.00
02.281.05	83 x 130	500	480.00
02.281.07	105 x 165	1000	720.00

02.282 Culture Jar with Screw Cap, Autoclaves, S-Glass, 75 x 130 mm (d x h), 450 ml. approx. **150.00**

02.285 Jars, Rectangular, Museum, Neutral glass with cover (Chromatography Tank).

Cat. No.	Height (mm) approx.	Length (mm) approx.	Breadth (mm) approx.	Price / Piece Rs.
02.285.01	140	215	100	1650.00
02.285.03	210	170	130	1900.00
02.285.05	220	140	140	1900.00
02.285.07	225	225	125	2400.00
02.285.09	250	250	150	3400.00
02.285.11	360	150	100	4400.00
02.285.15	380	280	230	9000.00

02.285A SS Lid for Museum Jars

Cat. No.	For Jar (mm) approx.	Price / Piece Rs.
02.285A.01	140 x 215 x 100	400.00
02.285A.03	210 x 170 x 130	500.00
02.285A.05	220 x 140 x 140	455.00
02.285A.07	225 x 225 x 125	525.00
02.285A.09	250 x 250 x 150	560.00

02.287 Jars-Bell, Round Bottom, Edge Ground "RELIGLAS".

Cat. No.	O.D. x Height (mm) approx.	Price / Piece Rs.
02.287.01	300 x 450	15700.00
02.287.03	300 x 400	14900.00
02.287.05	200 x 350	9500.00

02.295 Funnel Filtering, "RELIGLAS", 60° angle. Complies to IS 1591, ISO/ DIN 4798.

Cat. No.	Diameter (mm) approx.	Bottom Tube (Dia mm)	To suit Filter Paper Dia mm	Price / Piece Rs.
02.295.00	25	6	-	45.00
02.295.01	35	6	45-55	48.00
02.295.03	45	6	55-70	54.00
02.295.04	50	6	55-70	56.00
02.295.05	55	8	70-90	62.00
02.295.06	65	8	75-95	68.00
02.295.07	70	8	110-125	75.00
02.295.08	75	8	110-125	78.00
02.295.09	80	8	125-150	88.00
02.295.11	100	10	150-185	120.00
02.295.13	120	16	185-240	290.00
02.295.15	150	16	240-270	420.00
02.295.17	200	24	320-385	1200.00

02.297 Funnel-Powder, Short Plain Stem "RELIGLAS"

Cat. No.	Diameter (mm) approx.	Bottom Tube (Dia mm)	Price / Piece Rs.
02.297.01	55	20	94.00
02.297.03	70	22	102.00
02.297.05	80	24	110.00
02.297.07	100	26	175.00
02.297.09	125	35	320.00
02.297.11	150	35	460.00
02.297.13	200	40	1250.00

02.299 Powder Funnel with cone at stem, "RELIGLAS".

Cat. No.	Dia. (mm) Approx	Cone Size	Price / Piece (Rs.)
02.299.15	100	24/29	250.00
02.299.17	125	24/29	400.00
02.299.19	150	24/29	580.00
02.299.21	200	24/29	1350.00

02.301 Thistle Funnel, "RELIGLAS", 30 cm stem 80.00

02.302 Thistle Funnel, "RELIGLAS", for Kipp's Apparatus 144.00

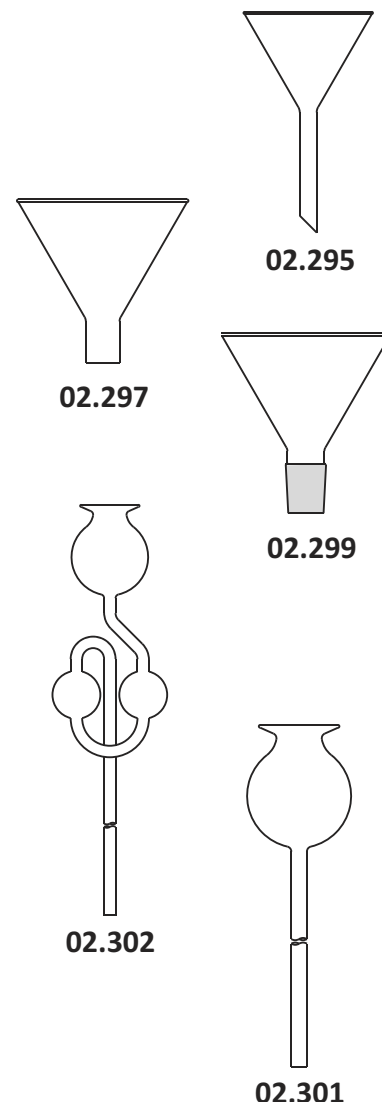

Funnels



FLASKS

02.305 Flasks, Erlenmeyer, "RELIGLAS", Conical, Narrow mouth, with approx. graduation. Complies to IS 1381-1, ISO/ DIN 1773.

Cat. No.	Capacity (ml)	Approx Neck (OD mm)	Graduation (Interval ml)	Price / Piece Rs.
02.305.03	5*	-	-	45.00
02.305.04	10*	-	-	48.00
02.305.05	25	22	-	74.00
02.305.10	50	22	-	78.00
02.305.15	100	26	25	84.00
02.305.20	150*	28	25	99.00
02.305.25	250	34	50	128.00
02.305.30	500	34	100	188.00
02.305.35	1000	42	200	340.00
02.305.40	2000	48	500	950.00
02.305.45	3000	48	500	1540.00
02.305.50	5000	50	500	2550.00

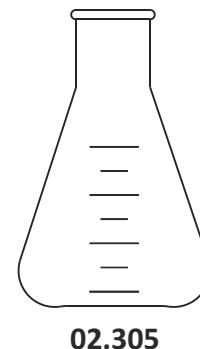

Note : Flasks 5 & 10ml capacity are ungraduated; \* Not covered in standard

## Flasks

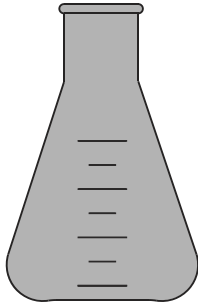

02.306

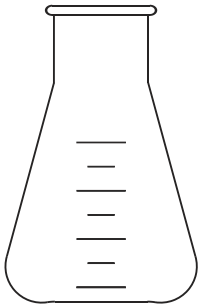

02.307

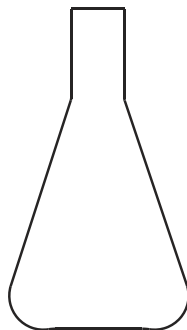

02.311

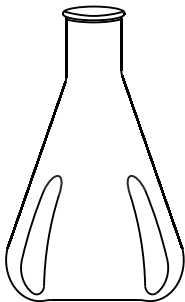

02.312

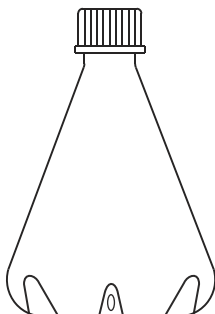

02.313

**02.306** Flasks, Erlenmeyer, "RELIGLAS", AMBER, Conical, Narrow mouth, with approx. graduation. Complies to IS 1381-1, ISO / DIN 1773.

Cat. No.	Capacity (ml.)	Price / Piece Rs.
02.306.10	50	175.00
02.306.15	100	190.00
02.306.25	250	256.00
02.306.30	500	420.00
02.306.35	1000	770.00
02.306.40	2000	1590.00

**02.307** Flasks Erlenmeyer, "RELIGLAS", Conical, Wide Mouth, Approx. graduation, Complies to IS 1381.

Cat. No.	Capacity (ml)	O.D. x Ht. (mm approx)	Approx Neck (O.D. mm)	Price / Piece Rs.
02.307.15	100	64 x 105	34	110.00
02.307.25	250	85 x 142	50	160.00
02.307.30	500	105 x 175	50	240.00
02.307.35	1000	130 x 220	56	420.00
02.307.40	2000	150 x 275	70	990.00

**02.311** Flasks Conical, "RELIGLAS", Rimless, Suitable for culture.

Cat. No.	Capacity (ml)	O.D. x Ht. (mm) approx.	Approx Neck (O.D. mm)	Price / Piece Rs.
02.311.25	250	78 x 154	25	185.00
02.311.32	750	114 x 210	34	395.00

**02.312** Flasks, Trypsinising, "RELIGLAS", for Culture, with Baffles.

Cat. No.	Capacity (ml)	Price / Piece (Rs.)
02.312.15	100	315.00
02.312.25	250	460.00
02.312.30	500	560.00
02.312.35	1000	850.00
02.312.40	2000	1650.00
02.312.50	5000	6000.00

**02.313** Flasks, Culture, "RELIGLAS", with 3 Baffles and PP Screw Cap.

Cat. No.	Capacity (ml)	Price / Piece (Rs.)
02.313.25	250	660.00
02.313.30	500	900.00
02.313.35	1000	1200.00
02.313.40	2000	2200.00

### 02.315 Flasks, Erlenmeyer, "RELIGLAS", Conical, with interchangeable stopper.

Cat. No.	Capacity (ml)	Stopper Size	Price / Piece Rs.
02.315.05	25	14/23	170.00
02.315.10	50	19/26	190.00
02.315.15	100	24/29	230.00
02.315.20	150	24/29	280.00
02.315.25	250	24/29	290.00
02.315.30	500	24/29	400.00
02.315.35	1000	29/32	610.00
02.315.40	2000	34/35	1350.00

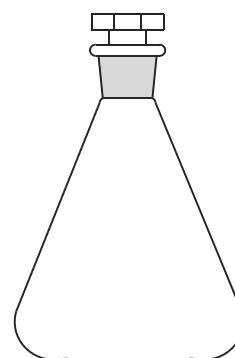

02.315

### 02.316 Flasks, Erlenmeyer, "RELIGLAS", AMBER, Conical, Narrow Mouth, with Interchangeable Stopper.

Cat. No.	Capacity (ml.)	Stopper Size	Price / Piece Rs.
02.316.05	25	14/23	285.00
02.316.10	50	19/26	300.00
02.316.15	100	24/29	370.00
02.316.25	250	24/29	460.00
02.316.30	500	24/29	675.00
02.316.35	1000	24/29	1050.00
02.316.40	2000	24/29	1950.00

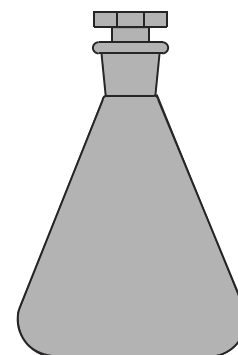

02.316

### 02.317 Flasks Erlenmeyer, "RELIGLAS", Conical, with Screw Cap and liner.

Cat. No.	Capacity (ml)	Thread Size	Price / Piece Rs.
02.317.05	25	GL-18	150.00
02.317.10	50	GL-18	187.00
02.317.15	100	GL-25	220.00
02.317.20	150	GL-25	260.00
02.317.25	250	GL-32	280.00
02.317.30	500	GL-32	380.00
02.317.35	1000	GL-32	680.00
02.317.40	2000	GL-32	1250.00
02.317.45	5000	GL-45	4500.00

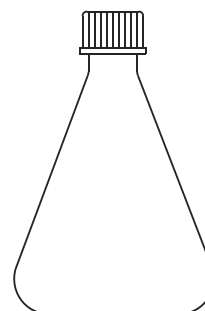

02.317

### 02.321 Flasks Iodine, "RELIGLAS", with funnel shaped cup and stopper.

Cat. No.	Capacity (ml)	Stopper Size	Price / Piece Rs.
02.321.15	100	24/29	230.00
02.321.25	250	24/29	270.00
02.321.30	500	24/29	350.00
02.321.35	1000	24/29	720.00

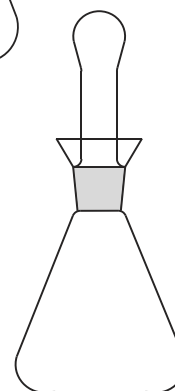

02.321

### 02.323 Flasks Filtering, Heavy wall, with tubulation, "RELIGLAS".

Cat. No.	Capacity (ml)	Price / Piece Rs.
02.323.10	50	175.00
02.323.15	100	260.00
02.323.25	250	410.00
02.323.30	500	530.00
02.323.35	1000	800.00
02.323.40	2000	1600.00
02.323.50	5000	5800.00
02.323.55	*10000	10200.00
02.323.60	*20000	14800.00

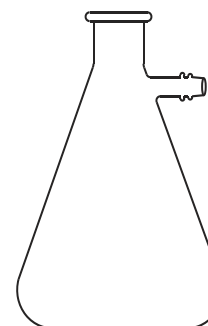

02.323

Note :\* Bottle shape

## Flasks

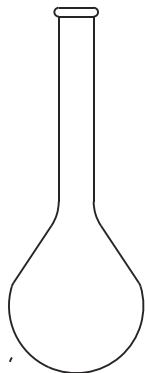

02.325

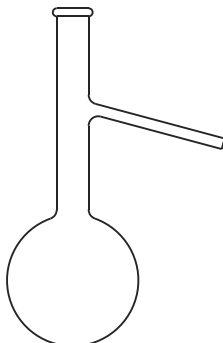

02.327

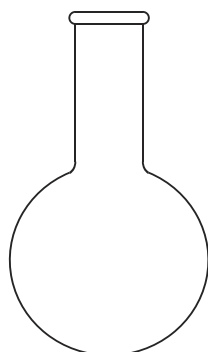

02.331

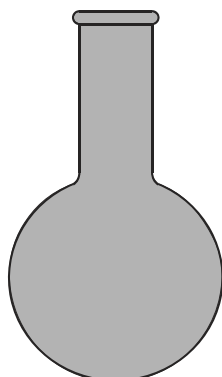

02.331A

## 02.325 Flasks, Kjeldhal, "RELIGLAS", Round Bottom, long neck, Plain

Cat. No.	Capacity (ml)	OD x Ht. (Approx. mm)	Price / Piece Rs.
02.325.03	10	30 x 180	80.00
02.325.07	30	40 x 180	110.00
02.325.10	50	45 x 200	150.00
02.325.15	100	60 x 220	185.00
02.325.27	300	80 x 300	300.00
02.325.30	500	98 x 325	490.00
02.325.33	800	115 x 350	600.00

## 02.327 Flasks Distillation, "RELIGLAS", with side tube at 75° angle.

Cat. No.	Capacity (ml)	O.D. x Ht. Approx. mm	Neck OD Approx. mm	Price / Piece Rs.
02.327.15	100	64 x 210	21	198.00
02.327.17	125*	68 x 214	19	210.00
02.327.25	250	88 x 226	25	280.00
02.327.30	500	110 x 250	28	350.00

Note : \* As per IP 123/64

## 02.331 Flasks Boiling, Round Bottom, "RELIGLAS". Complies to IS 1381-1, ISO 1773.

Cat. No.	Capacity (ml)	Price / Piece Rs.
02.331.05	25	80.00
02.331.10	50	88.00
02.331.15	100	110.00
02.331.20	150	120.00
02.331.25	250	134.00
02.331.30	500	220.00
02.331.35	1000	340.00
02.331.40	2000	980.00
02.331.45	3000	1580.00
02.331.50	5000	2650.00
02.331.55	10000	5500.00
02.331.60	20000	10900.00

## 02.331A Flasks Boiling, Round Bottom, "RELIGLAS". Complies to IS 1381-1, ISO 1773. AMBER

Cat. No.	Capacity (ml)	Price / Piece Rs.
02.331A.01	50	310.00
02.331A.03	100	440.00
02.331A.05	250	485.00
02.331A.07	500	752.00
02.331A.09	1000	1010.00
02.331A.11	2000	1568.00

**02.333 Flasks Boiling, Flat Bottom, "RELIGLAS". Complies to IS 1381-1, ISO 1773.**

Cat. No.	Capacity (ml)	Price / Piece (Rs.)
02.333.05	25	80.00
02.333.10	50	88.00
02.333.15	100	110.00
02.333.20	150	120.00
02.333.25	250	134.00
02.333.30	500	220.00
02.333.35	1000	340.00
02.333.40	2000	980.00
02.333.45	3000	1580.00
02.333.50	5000	2650.00
02.333.55	10000	5500.00
02.333.60	20000	10900.00

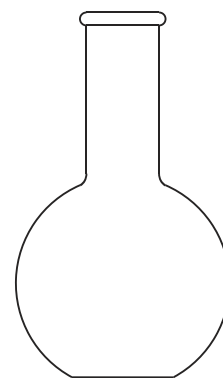

02.333

**02.333A Flasks Boiling, Flat Bottom, "RELIGLAS". AMBER, Complies to IS 1381-1, ISO 1773.**

Cat. No.	Capacity (ml)	Price / Piece Rs.
02.333A.01	50	310.00
02.333A.03	100	440.00
02.333A.05	250	485.00
02.333A.07	500	752.00
02.333A.09	1000	1010.00
02.333A.11	2000	1568.00

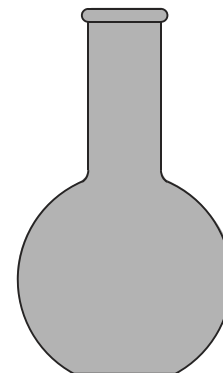

02.333A

**02.335 Flasks Culture, Haffkine "RELIGLAS"**

Cat. No.	Capacity (ml) approx.	O.D. x Ht. (mm) approx.	Price / Piece Rs.
02.335.45	3000	241 x 273	3000.00
02.335.47	4000	245 x 310	3500.00

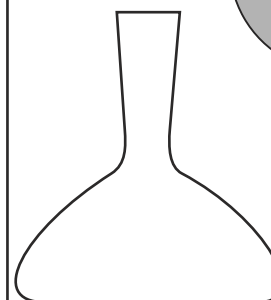

02.335

**02.338 Kettles Resin Reaction "RELIGLAS"**

Cat. No.	Capacity (ml.)	Price / Piece (Rs.)
02.338.05	500	8900.00
02.338.10	1000	9600.00
02.338.20	2000	12000.00
02.338.40	4000	14500.00

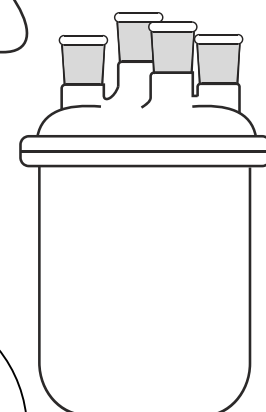

02.338

**02.340 Flask (Vessels), Reaction, "RELIGLAS", Wide Mouth with flat flange, ID 100mm, OD 150mm**

Cat. No.	Capacity (ml.)	Price / Piece (Rs.)
02.340.05	1000	2400.00
02.340.10	2000	3000.00
02.340.15	3000	4300.00
02.340.20	5000	5700.00
02.340.25	10000	9900.00
02.340.27	20000	15750.00

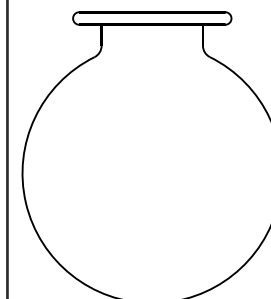

02.340

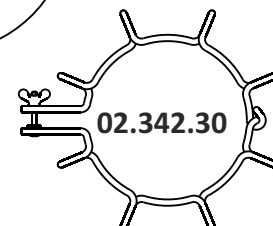

02.342.30

**02.342 Lids for Flask Reaction, "RELIGLAS", Flat Flange, ID 100mm, OD 150mm**

Cat. No.	Description	Price / Piece (Rs.)
02.342.05	Sockets 19/26, 19/26, 24/29, 19/26/ 19/26	4200.00
02.342.10	Sockets 19/26, 14/23, 14/23, 14/23, 29/32	4200.00
02.342.15	Sockets 29/32, 14/23, 14/23, 14/23, 29/32	4200.00
02.342.30	SS Wire clip for holding 100mm Flat Flange	750.00
02.342.34	PTFE Gasket for 100mm Flat Flange	650.00

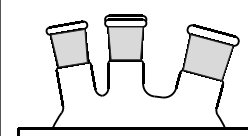

02.342



02.343

## 02.343 Flask Stand, Rubber

Cat. No.	For Flask Capacity (ml)	Price / Piece (Rs.) Rubber	Price/ Piece (Rs.) Silicon
02.343.01	25	60.00	180.00
02.343.03	50	80.00	210.00
02.343.05	100	120.00	288.00
02.343.07	250	172.00	432.00
02.343.09	500	350.00	804.00
02.343.11	1000	730.00	1680.00
02.343.13	2000	1280.00	3600.00

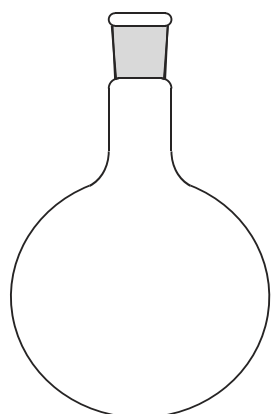

02.345

## 02.345 Flasks Round Bottom, "RELIGLAS", with socket.

Cat. No.	Capacity (ml)	Socket Size	Price / Piece Rs.
02.345.01	5	14/23	90.00
02.345.04	10	14/23	95.00
02.345.07	25	14/23	120.00
02.345.10	25	19/26	120.00
02.345.13	50	19/26	140.00
02.345.16	50	24/29	140.00
02.345.19	100	19/26	160.00
02.345.22	100	24/29	160.00
02.345.25	150	19/26	180.00
02.345.28	150	24/29	180.00
02.345.31	250	19/26	200.00
02.345.34	250	24/29	200.00
02.345.37	500	19/26	290.00
02.345.40	500	24/29	290.00
02.345.43	1000	24/29	440.00
02.345.46	2000	24/29	1100.00
02.345.49	3000	34/35	2100.00
02.345.52	5000	34/35	3250.00
02.345.55	10000	55/44	6200.00
02.345.58	20000	55/44	10500.00

**Note :** For long neck flasks 10% will be charged extra and also do mention the Short or Medium Neck, while placing order. Flasks with other sizes of sockets are also available on the same rates according to capacity.

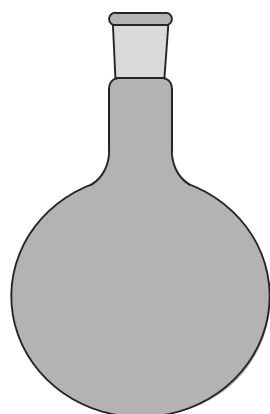

02.345A

## 02.345A Flasks Round Bottom, "RELIGLAS", with socket. AMBER

Cat. No.	Capacity (ml)	Socket Size	Price / Piece Rs.
02.345A.01	25	19/26	358.00
02.345A.03	50	19/26	385.00
02.345A.05	100	24/29	555.00
02.345A.07	150	24/29	625.00
02.345A.09	250	24/29	700.00
02.345A.11	500	24/29	990.00
02.345A.13	1000	24/29	1210.00
02.345A.15	2000	24/29	2130.00

**Note :** For long neck flasks 10% will be charged extra and also do mention the Short or Medium Neck, while placing order. Flasks with other sizes of sockets are also available on the same rates according to capacity.

02.347 Flasks Flat Bottom, "RELIGLAS", with socket.

Cat. No.	Capacity (ml)	Socket Size	Price / Piece Rs.
02.347.01	5	14/23	90.00
02.347.04	10	14/23	95.00
02.347.07	25	14/23	120.00
02.347.10	25	19/26	120.00
02.347.13	50	19/26	140.00
02.347.16	50	24/29	140.00
02.347.19	100	19/26	160.00
02.347.22	100	24/29	160.00
02.347.25	150	19/26	180.00
02.347.28	150	24/29	180.00
02.347.31	250	19/26	200.00
02.347.34	250	24/29	200.00
02.347.37	500	19/26	290.00
02.347.40	500	24/29	290.00
02.347.43	1000	24/29	440.00
02.347.46	2000	24/29	1100.00
02.347.49	3000	34/35	2100.00
02.347.52	5000	34/35	3250.00
02.347.55	10000	55/44	6200.00
02.347.58	20000	55/44	10500.00

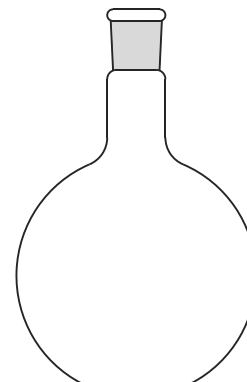

02.347

02.347A Flasks Flat Bottom, "RELIGLAS", with socket.

Cat. No.	Capacity (ml)	Socket Size	Price / Piece Rs.
02.347A.01	25	19/26	358.00
02.347A.03	50	19/26	385.00
02.347A.05	100	24/29	555.00
02.347A.07	150	24/29	625.00
02.347A.09	250	24/29	700.00
02.347A.11	500	24/29	990.00
02.347A.13	1000	24/29	1210.00
02.347A.15	2000	24/29	2130.00

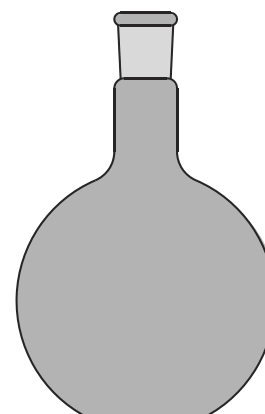

02.347A



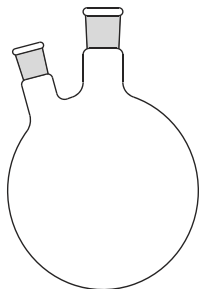

02.351-A

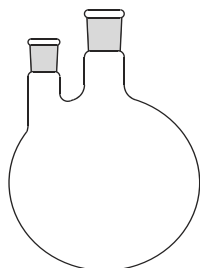

02.351-P

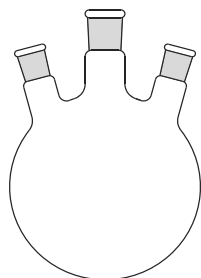

02.355-A

## 02.351A Flasks Round Bottom, Two Neck, "RELIGLAS", Side neck at Angle.

Cat. No.	Capacity (ml)	Centre Socket	Side Socket	Price / Piece Rs.
02.351A.01	25	19/26	14/23	230.00
02.351A.02	25	24/29	19/26	230.00
02.351A.04	50	19/26	14/23	235.00
02.351A.05	50	24/29	19/29	235.00
02.351A.07	100	24/29	14/23	240.00
02.351A.08	100	19/26	14/23	240.00
02.351A.10	250	24/29	14/23	330.00
02.351A.13	250	24/29	19/26	335.00
02.351A.16	500	24/29	14/23	475.00
02.351A.19	500	24/29	19/26	480.00
02.351A.22	1000	24/29	14/23	700.00
02.351A.25	1000	24/29	19/26	710.00
02.351A.28	2000	34/35	19/26	1250.00
02.351A.31	2000	24/29	19/26	1250.00
02.351A.34	3000	34/35	19/26	2750.00
02.351A.37	5000	34/35	24/29	4100.00
02.351A.40	5000	34/35	19/26	4100.00
02.351A.43	10000	55/44	24/29	7200.00
02.351A.46	20000	55/44	24/29	12400.00

## 02.351P Flasks Round Bottom, Two Neck, "RELIGLAS", Side neck at Parallel.

Cat. No.	Capacity (ml)	Center Socket	Side Socket	Price / Piece Rs.
02.351P.01	25	19/26	14/23	230.00
02.351P.02	25	24/29	19/26	230.00
02.351P.04	50	19/26	14/23	235.00
02.351P.05	50	24/29	19/29	235.00
02.351P.07	100	24/29	14/23	240.00
02.351P.08	100	19/26	14/23	240.00
02.351P.10	250	24/29	14/23	330.00
02.351P.13	250	24/29	19/26	335.00
02.351P.16	500	24/29	14/23	475.00
02.351P.19	500	24/29	19/26	480.00
02.351P.22	1000	24/29	14/23	700.00
02.351P.25	1000	24/29	19/26	710.00
02.351P.28	2000	34/35	19/26	1250.00
02.351P.31	2000	24/29	19/26	1250.00
02.351P.34	3000	34/35	19/26	2750.00
02.351P.37	5000	34/35	24/29	4100.00
02.351P.40	5000	34/35	19/26	4100.00
02.351P.43	10000	55/44	24/29	7200.00
02.351P.46	20000	55/44	24/29	12400.00

## 02.355A Flask Round Bottom, Three Neck, "RELIGLAS", Side necks at Angle.

Cat. No.	Capacity (ml)	Center Socket	Side Socket	Price / Piece Rs.
02.355A.03	50	19/26	14/23	300.00
02.355A.04	50	24/29	19/26	300.00
02.355A.06	100	19/26	14/23	330.00
02.355A.07	100	24/29	14/23	330.00
02.355A.10	250	24/29	14/23	435.00
02.355A.13	250	24/29	19/26	435.00
02.355A.16	500	24/29	14/23	650.00
02.355A.19	500	24/29	19/26	650.00
02.355A.22	1000	24/29	19/26	900.00
02.355A.25	1000	34/35	19/26	900.00
02.355A.28	2000	24/29	19/26	1600.00
02.355A.31	2000	34/35	24/29	1600.00
02.355A.34	3000	34/35	24/29	3500.00
02.355A.37	5000	34/35	19/26	4700.00
02.355A.40	10000	55/44	24/29	8000.00
02.355A.43	20000	55/44	24/29	13500.00

Note: Flasks with other combination of necks can also be supplied, on the same rates according to capacity.

**02.355P** Flask Round Bottom, Three Neck, "RELIGLAS", Side necks at Parallel.

Cat. No.	Capacity (ml)	Center Socket	Side Socket	Price / Piece Rs.
02.355P.03	50	19/26	14/23	300.00
02.355P.04	50	24/29	19/26	300.00
02.355P.06	100	19/26	14/23	330.00
02.355P.07	100	24/29	14/23	330.00
02.355P.10	250	24/29	14/23	435.00
02.355P.13	250	24/29	19/26	435.00
02.355P.16	500	24/29	14/23	650.00
02.355P.19	500	24/29	19/26	650.00
02.355P.22	1000	24/29	19/26	900.00
02.355P.25	1000	34/35	19/26	900.00
02.355P.28	2000	24/29	19/26	1600.00
02.355P.31	2000	34/35	24/29	1600.00
02.355P.34	3000	34/35	24/29	3500.00
02.355P.37	5000	34/35	19/26	4700.00
02.355P.40	10000	55/44	24/29	8000.00
02.355P.43	20000	55/44	24/29	13500.00

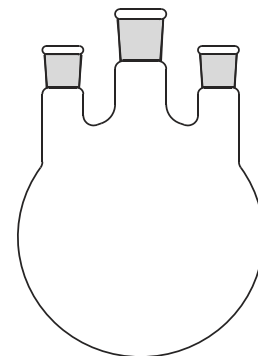

**02.355-P**

**Note :** Flasks with other combination of necks can also be supplied, on the same rates according to capacity.

**02.357** Flask Round Bottom, Four Neck, "RELIGLAS", Side necks at Angle.

Cat. No.	Capacity (ml)	Center Socket	Side Socket	Price / Piece Rs.
02.357.05	100	24/29	14/23	520.00
02.357.07	100	24/29	19/26	520.00
02.357.09	250	24/29	14/23	650.00
02.357.11	250	24/29	19/26	650.00
02.357.13	500	24/29	14/23	925.00
02.357.15	500	24/29	19/26	925.00
02.357.17	500	24/29	24/29	925.00
02.357.19	500	34/35	24/29	925.00
02.357.21	1000	24/29	14/23	1200.00
02.357.23	1000	24/29	19/26	1200.00
02.357.25	1000	24/29	24/29	1200.00
02.357.27	1000	34/35	24/29	1200.00
02.357.29	2000	24/29	14/23	1900.00
02.357.31	2000	24/29	19/26	1900.00
02.357.33	2000	34/35	19/26	1900.00
02.357.35	2000	34/35	24/29	1900.00
02.357.37	3000	34/35	19/26	3800.00
02.357.39	3000	34/35	24/29	3800.00
02.357.41	5000	34/35	19/26	5200.00
02.357.43	5000	34/35	24/29	5200.00
02.357.45	10000	55/44	24/29	10000.00
02.357.47	10000	34/35	24/29	10000.00
02.357.49	20000	55/44	24/29	14500.00

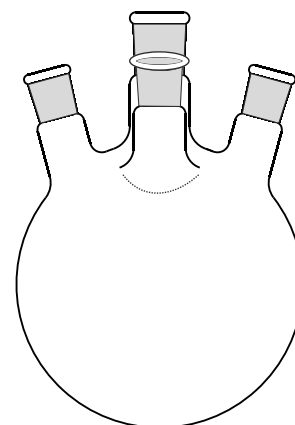

**02.357**

**Note :** Flasks with other combination of necks can also be supplied, on the same rates according to capacity.

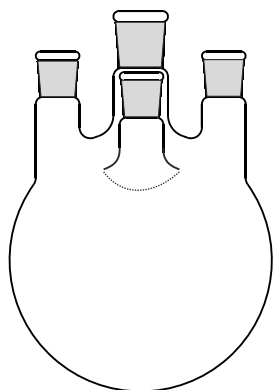

02.358

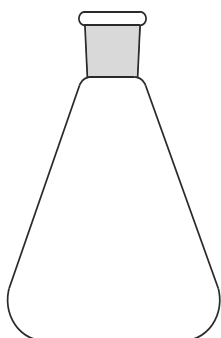

02.359

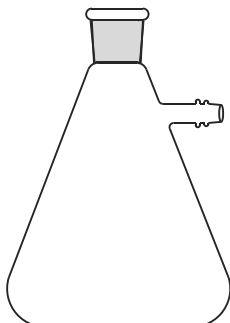

02.361

## 02.358 Flask Round Bottom, Four Neck, "RELIGLAS", Side necks at Parallel.

Cat. No.	Capacity (ml)	Center Socket	Side Socket	Price / Piece Rs.
02.358.05	100	24/29	14/23	520.00
02.358.07	100	24/29	19/26	520.00
02.358.09	250	24/29	14/23	650.00
02.358.11	250	24/29	19/26	650.00
02.358.13	500	24/29	14/23	925.00
02.358.15	500	24/29	19/26	925.00
02.358.17	500	24/29	24/29	925.00
02.358.19	500	34/35	24/29	925.00
02.358.21	1000	24/29	14/23	1200.00
02.358.23	1000	24/29	19/26	1200.00
02.358.25	1000	24/29	24/29	1200.00
02.358.27	1000	34/35	24/29	1200.00
02.358.29	2000	24/29	14/23	1900.00
02.358.31	2000	24/29	19/26	1900.00
02.358.33	2000	34/35	19/26	1900.00
02.358.35	2000	34/35	24/29	1900.00
02.358.37	3000	34/35	19/26	3800.00
02.358.39	3000	34/35	24/29	3800.00
02.358.41	5000	34/35	19/26	5200.00
02.358.43	5000	34/35	24/29	5200.00
02.358.45	10000	55/44	24/29	10000.00
02.358.47	10000	34/35	24/29	10000.00
02.358.49	20000	55/44	24/29	14500.00

Note: Flasks with other combination of necks can also be supplied, on the same rates according to capacity.

## 02.359 Flask Erlenmeyer, "RELIGLAS", Conical, with socket

Cat. No.	Capacity (ml)	Socket	Price / Piece (Rs.)
02.359.01	25	14/23	110.00
02.359.04	50	14/23	125.00
02.359.07	50	19/26	125.00
02.359.10	100	19/26	160.00
02.359.13	100	24/29	160.00
02.359.16	150	19/26	180.00
02.359.19	150	24/29	180.00
02.359.22	250	19/26	190.00
02.359.25	250	24/29	190.00
02.359.28	250	29/32	190.00
02.359.31	500	19/26	280.00
02.359.34	500	24/29	280.00
02.359.37	500	29/32	280.00
02.359.40	1000	24/29	540.00
02.359.43	1000	34/35	550.00
02.359.46	2000	24/29	1000.00
02.359.49	2000	34/35	1020.00

## 02.361 Flasks, Buchner, "RELIGLAS", Filtration, Heavy wall, with tubulation and socket.

Cat. No.	Capacity (ml)	Socket	Price / Piece (Rs.)
02.361.10	100	19/26	280.00
02.361.13	250	24/29	450.00
02.361.16	500	24/29	590.00
02.361.19	1000	24/29	1100.00
02.361.22	1000	34/35	1120.00
02.361.25	2000	34/35	1900.00

**02.365 Flasks, Kjeldahl, "RELIGLAS" with Socket.**

Cat. No.	Capacity (ml)	Socket	Price / Piece (Rs.)
02.365.07	50	19/26	190.00
02.365.10	100	19/26	210.00
02.365.13	100	24/29	220.00
02.365.16	300	24/29	400.00
02.365.19	500	24/29	520.00
02.365.22	800	24/29	650.00
02.365.25	800	29/32	670.00

**02.367 Flasks, Florentine, "RELIGLAS" with Socket.**

Cat. No.	Capacity (ml)	Socket	Price / Piece Rs.
02.367.07	50	19/26	250.00
02.367.08	50	24/29	260.00
02.367.09	50	29/32	270.00
02.367.10	100	19/26	320.00
02.367.13	100	24/29	330.00
02.367.14	100	29/32	340.00
02.367.16	250	24/29	470.00
02.367.17	250	29/32	480.00
02.367.19	500	24/29	590.00
02.367.20	500	29/32	600.00
02.367.22	800	24/29	840.00
02.367.25	800	29/32	850.00
02.367.27	1000	29/32	1020.00
02.367.29	2000	29/32	1500.00

**Note:** Florentine Flask with other sockets can also be supplied on same rates

**02.369A Test Tube "RELIGLAS" with Side Arm and Stopcock, Schlenk Type with stopper.**

Cat. No.	Capacity (ml)	Socket	Price / Piece Rs.
02.369A.01	10	19/26	298.00
02.369A.03	20	14/23	325.00
02.369A.05	25	19/26	358.00
02.369A.07	50	19/26	390.00
02.369A.09	100	24/29	446.00
02.369A.11	150	24/29	654.00

**02.369B Flask, Round/ Flat Bottom "RELIGLAS" with Side Arm and Stopcock, Schlenk Type**

Cat. No.	Capacity (ml)	Socket	Price / Piece Rs.
02.369B.01	25	19/26	350.00
02.369B.03	50	14/23	375.00
02.369B.05	100	24/29	412.00
02.369B.07	250	24/29	467.00
02.369B.09	500	24/29	635.00
02.369B.11	1000	24/29	835.00
02.369B.13	1000	24/29	2225.00

**02.369C Reagent Bottle "RELIGLAS" with Side Arm and Stopcock, Schlenk Type with screw cap.**

Cat. No.	Capacity (ml)	Thread	Price / Piece Rs.
02.369C.01	50	GL-32	550.00
02.369C.03	100	GL-45	620.00
02.369C.05	250	GL-45	634.00
02.369C.07	500	GL-45	695.00
02.369C.09	1000	GL-45	970.00
02.369C.11	2000	GL-45	2225.00

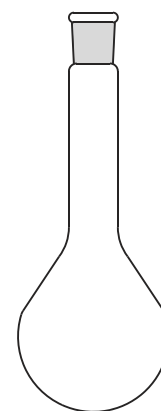

02.365

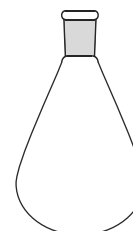

02.367

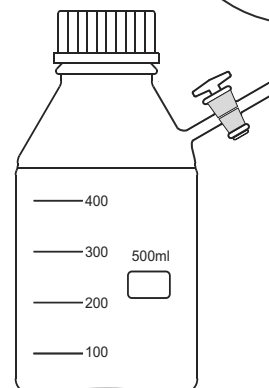
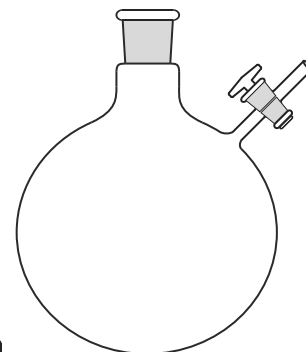
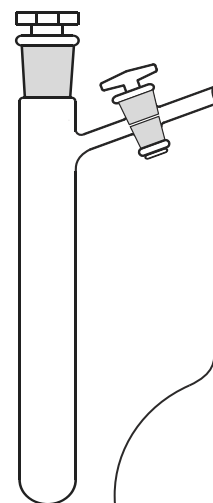

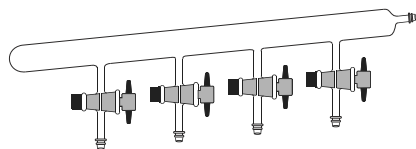

03.369D.03

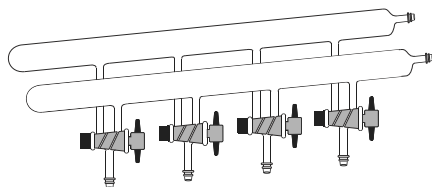

03.369E.03

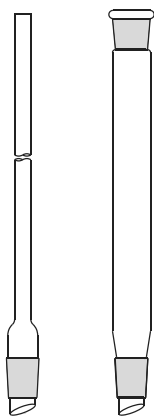

03.375

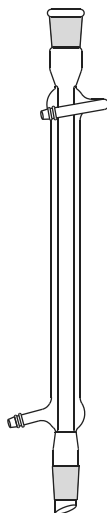

03.377

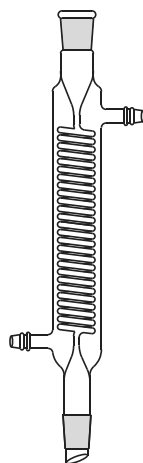

03.379

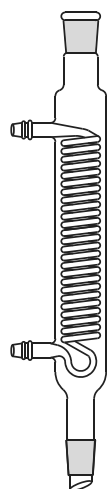

03.381

## 02.369D Vacuum Manifold "RELI GLAS", Single Bank with PTFE Stopcocks.

Cat. No.	No. of Ports	Price / Piece Rs.
02.369D.01	3	12250.00
02.369D.03	4	13250.00
02.369D.05	5	15000.00

## 02.369E Vacuum Manifold "RELI GLAS", Double Bank with PTFE Stopcocks.

Cat. No.	No. of Ports	Price / Piece Rs.
02.369E.01	3	34600.00
02.369E.03	4	35800.00
02.369E.05	5	38900.00

Note: Side joints can be provided on request.

## 02.369F Flask, Double Walled "RELI GLAS" Round Bottom with Socket.

Cat. No.	Capacity (ml)	Socket	Price / Piece (Rs.)
02.369F.01	1000	24/29	19850.00
02.369F.03	2000	24/29	21750.00



## CONDENSERS

## 03.375 Air Condensers, "RELI GLAS"

Cat. No.	Socket	Cone	Effective Length (mm)	Price / Piece Rs.
03.375.01	14/23	14/23	200	180.00
03.375.04	19/26	19/26	200	210.00
03.375.08	24/29	24/29	250	300.00
03.375.16	19/26	19/26	400	330.00
03.375.20	24/29	24/29	500	375.00
03.375.24	—	19/26	750	200.00
03.375.28	—	24/29	750	210.00

## 03.377 Liebig Condensers, "RELI GLAS"

Cat. No.	Socket	Cone	Effective Length (mm)	Price / Piece Rs.
03.377.01	14/23	14/23	150	260.00
03.377.04	19/26	19/26	200	290.00
03.377.08	19/26	19/26	300	345.00
03.377.12	24/29	24/29	300	390.00
03.377.16	19/26	19/26	400	420.00
03.377.20	24/29	24/29	400	440.00
03.377.24	29/32	29/32	250	485.00
03.377.28	29/32	29/32	400	590.00

## 03.379 Coil Condensers, "RELI GLAS" Graham, Coil Distillate Type.

Cat. No.	Socket	Cone	Effective Length (mm)	Price / Piece Rs.
03.379.01	24/29	24/29	300	650.00
03.379.04	24/29	24/29	400	720.00
03.379.10	24/29	24/29	500	800.00

## 03.381 Coil Condensers, "RELI GLAS" Graham, Jacket Distillate Type.

Cat. No.	Socket	Cone	Effective Length (mm)	Price / Piece Rs.
03.381.01	19/26	19/26	200	550.00
03.381.04	19/23	19/23	300	640.00
03.381.08	24/29	24/29	300	650.00
03.381.09	24/29	24/29	400	720.00
03.381.12	29/32	29/32	165	600.00
03.381.16	29/32	29/32	320	680.00

Note: 03.377 to 03.381 can be supplied with removable plastic connectors at Rs. 80.00 extra.

**03.385 Double Coil Condensers, "RELI GLAS" with common inlet.**

Cat. No.	Socket	Cone	Effective Length (mm)	Price / Piece Rs.
03.385.01	19/26	19/26	200	1150.00
03.385.04	24/29	24/29	200	1200.00
03.385.08	34/35	34/35	350	2900.00
03.385.12	34/35	34/35	450	4350.00
03.385.16	34/35	34/35	600	4950.00

**03.391 Davies Condensers, "RELI GLAS" (Double Surface).**

Cat. No.	Socket	Cone	Effective Length (mm)	Price / Piece Rs.
03.391.01	19/26	19/26	150	575.00
03.391.04	19/26	19/26	200	620.00
03.391.05	19/26	19/26	300	725.00
03.391.08	24/29	24/29	200	630.00
03.391.12	29/32	29/32	200	645.00
03.391.16	24/29	24/29	300	740.00
03.391.17	24/29	24/29	400	840.00
03.391.19	34/35	34/35	500	1250.00

**03.393 Jacketed Coil Condensers, "RELI GLAS".**

Cat. No.	Socket	Cone	Effective Length (mm)	Price / Piece Rs.
03.393.01	19/26	19/26	160	630.00
03.393.04	24/29	24/29	160	645.00
03.393.08	29/32	29/32	160	680.00
03.393.12	19/26	19/26	200	695.00
03.393.16	24/29	24/29	200	710.00
03.393.20	19/26	19/26	300	810.00
03.393.24	24/29	24/29	300	825.00

**03.395 Inland Revenue Condensers, "RELI GLAS".**

Cat. No.	Socket	Cone	Effective Length (mm)	Price / Piece Rs.
03.395.01	19/26	19/26	200	820.00
03.395.04	24/29	24/29	200	830.00

**03.397 Allihn Condensers, "RELI GLAS" (Bulb Condenser).**

Cat. No.	Socket	Cone	Effective Length (mm)	Price / Piece Rs.
03.397.01	---	34/35	200	500.00
03.397.04	---	40/38	200	550.00
03.397.08	---	50/42	250	750.00
03.397.12	19/26	19/26	200	410.00
03.397.16	24/29	24/29	300	500.00
03.397.20	24/29	24/29	400	590.00
03.397.22	29/32	29/32	400	650.00
03.397.24	29/32	29/32	600	750.00

**03.399 Friedrich Condensers, "RELI GLAS".**

Cat. No.	Socket	Cone	Effective Length (mm)	Price / Piece Rs.
03.399.01	19/26 or 24/29	19/26 or 24/29	200	1600.00

Note: Cat. no. 03.385 to 03.399 can be supplied with removable plastic connectors at Rs. 80 extra.

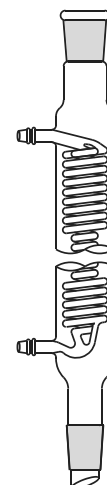

03.385

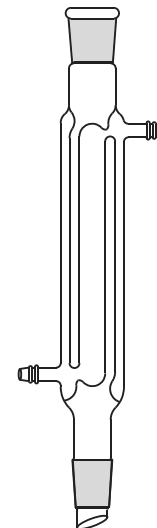

03.391

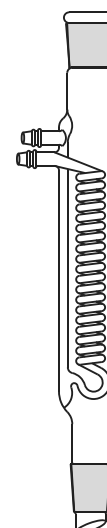

03.393

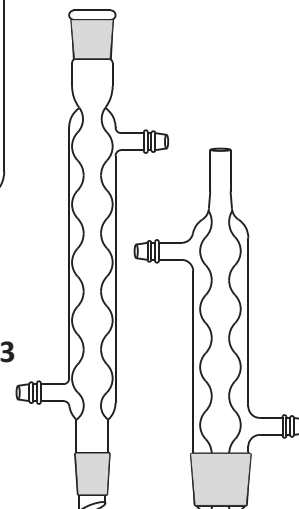

03.397

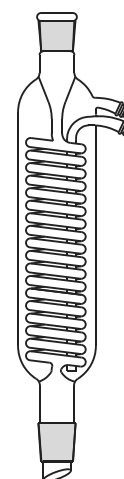

03.395

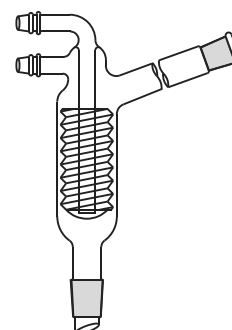

03.399

Condensers/ Standard Joints

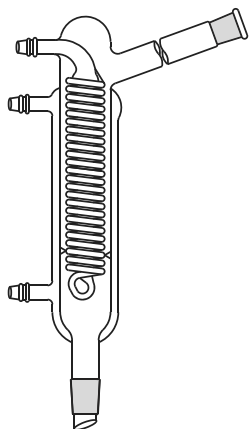

03.405

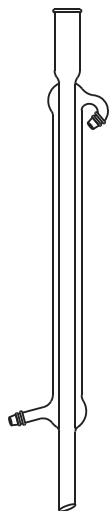

03.411



03.421

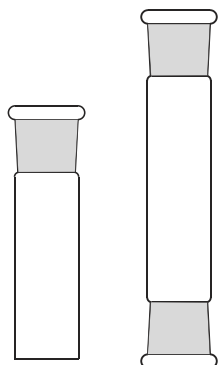

03.425

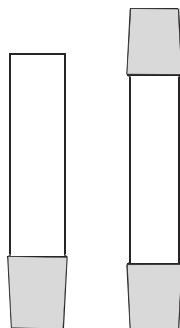

03.431



03.432

03.405 Ether Condensers, "RELIGLAS".

Cat. No.	Socket	Cone	Effective Length (mm)	Price / Piece Rs.
03.405.01	19/26	24/29	200	2500.00

03.411 Liebig Condensers "RELIGLAS".

Cat. No.	Effective Length (mm)	Price / Piece Rs.
03.411.01	200	230.00
03.411.04	300	245.00
03.411.08	400	285.00
03.411.10	500	400.00

03.421 Condensers, "RELIGLAS", Bulb shape, suitable for 1000 ml. spout less, Tall form, Beaker. 490.00

Note: Cat. no. 03.405 to 03.421 can be supplied with removable plastic connectors at Rs. 80 extra.

❖ STANDARD JOINTS, STOPPERS & ADAPTERS

03.425 Sockets, "RELIGLAS", Single or Double

Cat. No.	Socket Size	Price / Piece Rs. (Single)	Price / Piece Rs. (Double)
03.425.01	7/16	54.00	85.00
03.425.03	10/19	54.00	85.00
03.425.05	12/21	57.00	90.00
03.425.07	14/23	57.00	90.00
03.425.09	19/26	62.00	99.00
03.425.11	24/29	75.00	110.00
03.425.13	29/32	110.00	150.00
03.425.15	34/35	140.00	200.00
03.425.17	40/38	190.00	290.00
03.425.19	45/40	250.00	350.00
03.425.21	50/42	280.00	390.00
03.425.23	55/44	360.00	500.00

Note : Sockets with Hooks, 10% extra.

03.431 Cones, "RELIGLAS", Single or Double

Cat. No.	Cone Size	Price / Piece Rs. (Single)	Price / Piece Rs. (Double)
03.431.01	7/16	54.00	85.00
03.431.03	10/19	54.00	85.00
03.431.05	12/21	57.00	90.00
03.431.07	14/23	57.00	90.00
03.431.09	19/26	62.00	99.00
03.431.11	24/29	75.00	110.00
03.431.13	29/32	110.00	150.00
03.431.15	34/35	140.00	200.00
03.431.17	40/38	190.00	290.00
03.431.19	45/40	250.00	350.00
03.431.21	50/42	280.00	390.00
03.431.23	55/44	360.00	500.00

Note : Cones with tip, 10% extra, for hooks, 10% extra.

03.432 Clips, Plastic for Holding Cone and Sockets

Cat. No.	Joint Size	Price / Piece (Rs.)
03.432.07	14/19	20.00
0.3432.09	19/26	22.00
03.432.11	24/29	28.00
03.432.13	29/32	35.00
03.432.15	34/35	45.00

03.435 Ball & Socket, "RELIGLAS".

Cat. No.	Joint Size	Approx. Bore mm	Price Pair Rs.	SS CLIP Rs.
03.435.01	S 13	2	220.00	135.00
03.435.03	S 13	5	220.00	135.00
03.435.05	S 19	9	250.00	165.00
03.435.07	S 29	15	360.00	190.00
03.435.09	S 35	21	470.00	220.00
03.435.11	S 41	32	1100.00	430.00

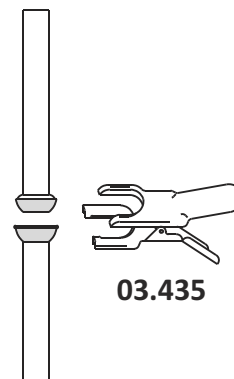

03.435

03.441 Stoppers, "RELIGLAS", Hollow.

Cat. No.	Shape	For Neck Size	Price / Piece (Rs.)
03.441.01	Hexagonal Head	10/19	24.00
03.441.03	Hexagonal Head	12/21	27.00
03.441.05	Hexagonal Head	14/23	24.00
03.441.07	Hexagonal Head	19/26	30.00
03.441.09	Hexagonal Head	24/29	40.00
03.441.10	Hexagonal Head	29/32	66.00
03.441.13	Hexagonal Head	34/35	100.00
03.441.15	Penny Head	40/38	240.00
03.441.17	Penny Head	45/40	300.00
03.441.19	Penny Head	50/42	330.00
03.441.21	Penny Head	55/44	350.00

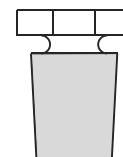

03.441

03.443 Stoppers, "RELIGLAS", Solid, Penny Head.

Cat. No.	For Neck Size	Price / Piece (Rs.)
03.443.01	10/19	33.00
03.443.03	14/23	38.00
03.443.05	19/26	52.00
03.443.07	24/29	85.00
03.443.09	29/32	132.00
03.443.11	34/35	225.00
03.443.15	for BOD Bottle	70.00



03.443

03.444 Stoppers, "RELIGLAS", AMBER, Solid, Penny Head.

Cat. No.	For Neck Size	Price / Piece (Rs.)
03.444.01	10/19	54.00
03.444.03	14/23	62.00
03.444.05	19/26	96.00
03.444.07	24/29	145.00
03.444.09	29/32	220.00
03.444.11	34/35	330.00
03.444.15	for BOD Bottle	110.00



03.444

03.445 Stoppers, "RELIGLAS", Solid, Flat Head.

Cat. No.	For Neck Size	Price / Piece (Rs.)
03.445.01	10/19	38.00
03.445.03	14/23	44.00
03.445.05	19/26	57.00
03.445.07	24/29	90.00
03.445.09	29/32	144.00
03.445.11	34/35	240.00

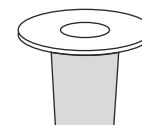

03.445

03.446 Stoppers, "RELIGLAS", Hollow, Amber.

Cat. No.	For Neck Size	Price / Piece (Rs.)
03.446.01	10/19	50.00
03.446.03	14/23	53.00
03.446.05	19/24	58.00
03.446.07	24/29	70.00
03.446.10	29/32	125.00
03.446.11	34/35	148.00

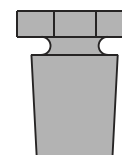

03.446



Adapters

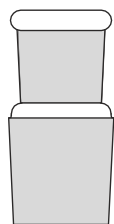

03.451

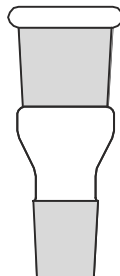

03.453

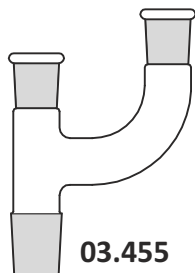

03.455

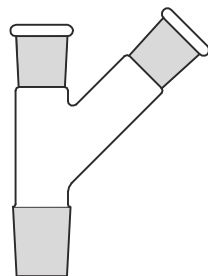

03.457

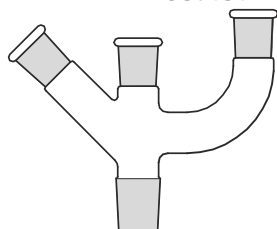

03.459

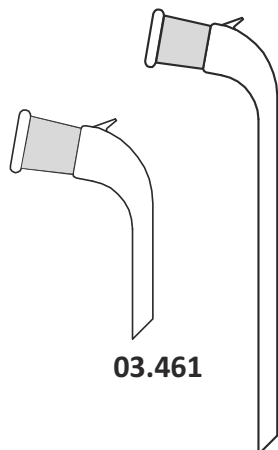

03.461

03.451 Reduction Adapters, "RELIGLAS".

Cat. No.	Socket	Cone	Price / Piece (Rs.)
03.451.01	14/23	19/26	89.00
03.451.04	14/23	24/29	99.00
03.451.08	19/26	24/29	104.00
03.451.12	19/26	29/32	120.00
03.451.16	19/26	34/35	140.00
03.451.20	24/29	29/32	130.00
03.451.24	24/29	34/35	150.00
03.451.28	24/29	40/38	190.00
03.451.32	24/29	55/44	300.00
03.451.36	29/32	34/35	175.00
03.451.40	29/32	40/38	210.00
03.451.43	29/32	34/35	175.00
03.451.45	34/35	50/42	320.00

Note: Reduction adapters of any other combination can also be supplied.

03.453 Expansion Adapters, "RELIGLAS".

Cat. No.	Socket	Cone	Price / Piece (Rs.)
03.453.01	19/26	14/23	100.00
03.453.04	24/29	14/23	125.00
03.453.08	24/29	19/26	125.00
03.453.12	29/32	19/26	150.00
03.453.16	29/32	24/29	160.00
03.453.20	34/35	19/26	175.00
03.453.24	34/35	24/29	180.00
03.453.28	34/35	29/32	200.00
03.453.32	40/38	24/29	240.00

Note: Expansion adapters of any other combination can also be supplied.

03.455 Multiple Adapters, "RELIGLAS", with Two Necks Parallel.

Cat. No.	Socket	Cone	Price / Piece Rs.
03.455.01	14/23	14/23	210.00
03.455.03	19/26	19/26	240.00
03.455.05	19/26	24/29	250.00
03.455.07	24/29	24/29	290.00
03.455.09	29/32	29/32	370.00

03.457 Multiple Adapters, "RELIGLAS", with Two Necks at 45°.

Cat. No.	Socket	Cone	Price / Piece Rs.
03.457.01	19/26	19/26	240.00
03.457.03	19/26	24/29	250.00

03.459 Multiple Adapters, "RELIGLAS", with Three Necks, Two Parallel and one at 45°.

Cat. No.	Socket	Cone	Price / Piece Rs.
03.459.01	19/26	24/29	340.00
03.459.03	19/26	29/32	398.00
03.459.05	19/26	34/35	415.00

03.461 Receiver Adapters, "RELIGLAS", Plain Bend Short / Long.

Cat. No.	Socket	Price / Piece Rs.
03.461.01	14/23	99.00
03.461.03	19/26	120.00
03.461.05	24/29	125.00
03.461.07	29/32	150.00
03.461.09	34/35	180.00

03.463 Straight Delivery Adapters, "RELIGLAS".

Cat. No.	Socket	Price / Piece Rs.
03.463.01	14/23	99.00
03.463.03	19/26	110.00
03.463.05	24/29	125.00
03.463.07	29/32	150.00
03.463.09	34/35	180.00

03.465 Receiver Adapters, "RELIGLAS", Bend with Vent.

Cat. No.	Socket	Cone	Price / Piece Rs.
03.465.01	14/23	14/23	170.00
03.465.03	19/26	19/26	198.00
03.465.05	19/26	24/29	205.00
03.465.07	24/29	24/29	230.00
03.465.09	34/35	34/35	340.00

03.467 Receiver Adapters, "RELIGLAS", Bend or Straight with Vacuum connection.

Cat. No.	Socket	Cone	Price / Piece Rs.
03.467.01	14/23	14/23	210.00
03.467.03	19/26	19/26	220.00
03.467.05	19/26	24/29	225.00
03.467.07	24/29	24/29	260.00
03.467.09	24/29	34/35	325.00
03.467.11	29/32	29/32	340.00

03.469 Receiver Adapters, "RELIGLAS", with Socket Connections.

Cat. No.	Socket	Cone	Price / Piece Rs.
03.469.01	14/23	14/23	235.00
03.469.03	19/26	19/26	250.00
03.469.05	19/26	24/29	270.00

03.471 Receiver Adapters, "RELIGLAS", Bend with Multiple Connections (Pig).

Cat. No.	Socket	Cone	Price / Piece Rs.
03.471.01	14/23	14/23	420.00
03.471.03	14/23	19/26	435.00
03.471.05	19/26	19/26	450.00

03.475 Receiver Adapters "RELIGLAS", Plain Bend.

Cat. No.	Socket	Cone	Price / Piece Rs.
03.475.01	19/26	19/26	180.00
03.475.03	19/26	24/29	185.00
03.475.05	24/29	24/29	210.00
03.475.06	29/32	29/32	270.00
03.475.07	34/35	34/35	300.00

❖ STILL / SPLASH / RECOVERY HEADS

03.481 Still Heads, Recovery Bend, "RELIGLAS", Sloping (Elbow).

Cat. No.	Cone Fitting Flask	Cone Fitting Condenser	Price / Piece Rs.
03.481.01	14/23	14/23	140.00
03.481.03	19/26	19/26	170.00
03.481.05	24/29	19/26	210.00
03.481.07	24/29	24/29	200.00
03.481.09	34/35	24/29	265.00
03.481.11	29/32	29/32	250.00

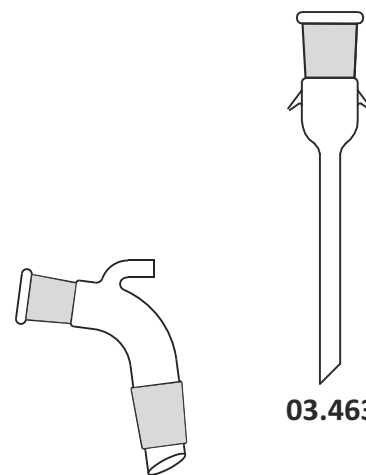

03.463

03.465

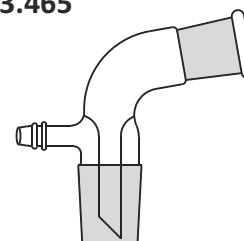

03.467

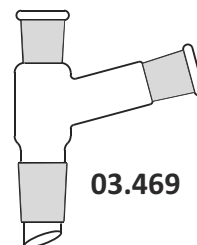

03.469

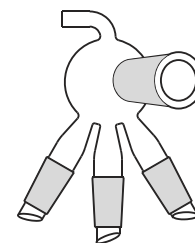

03.471

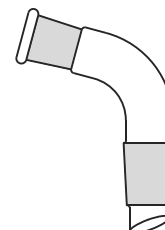

03.475

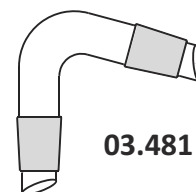

03.481

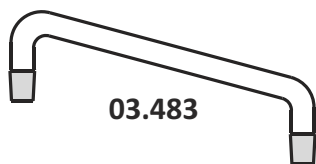

03.483

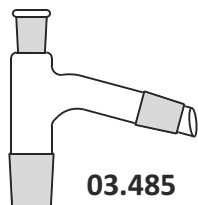

03.485

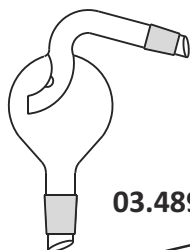

03.489

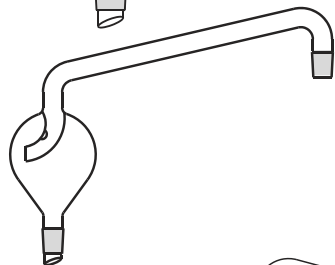

03.491



03.493

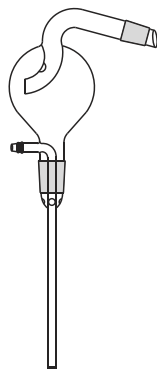

03.495

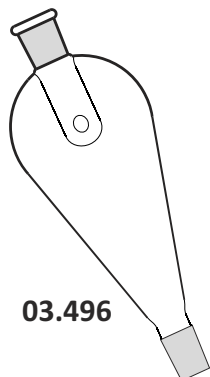

03.496

**03.483 Still Heads, Recovery Bend, "RELIGLAS", Vertical.**

Cat. No.	Cone Fitting Flask	Cone Fitting Condenser	Price / Piece Rs.
03.483.01	14/23	14/23	180.00
03.483.03	19/26	19/26	210.00
03.483.04	24/29	19/26	240.00
03.483.05	24/29	24/29	275.00
03.483.06	29/32	29/32	400.00
03.483.07	34/35	34/35	420.00

**03.485 Recovery Head, "RELIGLAS", Sloping with 14/23 Socket.**

Cat. No.	Thermometer Socket	Cone Fitting Flask	Cone Fitting Condenser	Price / Piece Rs.
03.485.01	14/23	14/23	14/23	215.00
03.485.03	14/23	19/26	19/26	240.00
03.485.05	14/23	24/29	19/26	265.00
03.485.07	14/23	24/29	24/29	275.00
03.485.09	14/23	34/35	24/29	435.00
03.485.11	19/26	19/26	19/26	275.00
03.485.13	19/26	24/29	24/29	295.00
03.485.15	14/23	34/35	34/35	450.00
03.485.17	14/23	29/32	29/32	350.00

**03.489 Splash Heads, "RELIGLAS", Pear Shape, Sloping.**

Cat. No.	Cone Fitting Flask	Cone Fitting Condenser	Price / Piece Rs.
03.489.01	19/26	19/26	320.00
03.489.03	24/29	19/26	330.00
03.489.05	34/35	24/29	410.00
03.489.07	24/29	24/29	380.00
03.489.09	29/32	29/32	450.00

**03.491 Splash Heads, "RELIGLAS", Pear Shape, Vertical**

Cat. No.	Cone Fitting Flask	Cone Fitting Condenser	Price / Piece Rs.
03.491.01	19/26	19/26	410.00
03.491.03	24/29	19/26	360.00
03.491.05	24/29	24/29	400.00
03.491.07	34/35	24/29	460.00
03.491.09	29/32	29/32	480.00

**03.493 Splash Head Adapter, "RELIGLAS".**

Cat. No.	Cone Fitting Flask	Socket Fitting Adapter	Price / Piece Rs.
03.493.01	24/29	19/26	310.00

**03.495 Steam Distillation Heads "RELIGLAS" Pear Shape, Sloping.**

Cat. No.	Cone Fitting Flask	Cone Fitting Condenser	Price / Piece Rs.
03.495.01	24/29	19/26	430.00
03.495.03	34/35	19/26	440.00
03.495.05	34/35	24/29	450.00

**NOTE:** For removable Plastic Screw Connector Rs. 32.00 extra

**❖ TRAPS**

**03.496 Trap for Rotary Evaporator, Boulanger, self washing, "RELIGLAS"**

Cat. No.	Capacity ml.	Socket	Cone	Price / Piece Rs.
03.496.01	100	24/29	14/23	510.00
03.496.03	100	24/29	24/29	530.00
03.496.05	250	24/29	14/23	585.00
03.496.07	250	24/29	24/29	595.00

03.497 Trap for Rotary Evaporator, Anti Splash, "RELIGLAS"

Cat. No.	Capacity ml.	Socket	Cone	Price / Piece Rs.
03.497.01	100	24/29	14/23	485.00
03.497.03	100	24/29	24/29	495.00
03.497.05	100	29/32	14/23	495.00
03.497.07	250	24/29	24/29	550.00
03.497.09	250	29/32	29/32	570.00
03.497.11	500	24/29	24/29	650.00

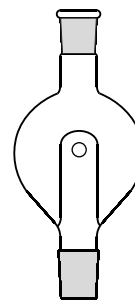

03.497

03.498 Trap for Rotary Evaporator, Anti Splash improved, "RELIGLAS", Two Drain holes close to base of the inner tube.

Cat. No.	Capacity ml.	Socket	Cone	Price / Piece Rs.
03.498.01	100	24/29	14/23	485.00
03.498.03	100	24/29	24/29	495.00
03.498.05	100	29/32	14/23	495.00
03.498.07	250	24/29	24/29	550.00
03.498.09	250	29/32	29/32	570.00
03.498.11	500	24/29	24/29	650.00

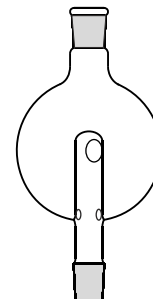

03.498

03.499 Trap for Rotary Evaporator, Anti climb, "RELIGLAS"

Cat. No.	Capacity ml.	Socket	Cone	Price / Piece Rs.
03.499.01	100	24/29	14/23	485.00
03.499.03	100	24/29	24/29	495.00
03.499.05	100	29/32	14/23	495.00
03.499.07	250	24/29	24/29	550.00
03.499.09	250	29/32	29/32	570.00
03.499.11	500	24/29	24/29	650.00

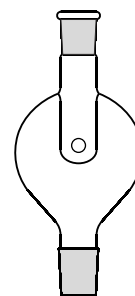

03.499

❖ MISCELLANEOUS FITTINGS

03.501 Adapters with Stopcock, "RELIGLAS", Cone to Rubber Tubing, Straight/ Rt. angle connection, with Stopcock.

Cat. No.	Cone	Price / Piece Rs.
03.501.01	14/23	240.00
03.501.03	19/26	250.00
03.501.05	24/29	260.00
03.501.06	29/32	290.00
03.501.07	34/35	360.00

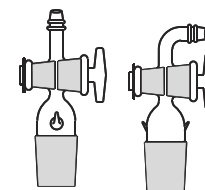

03.501

03.505 Adapters, "RELIGLAS", Cone to rubber tubing, straight/ Rt. angle connection.

Cat. No.	Cone	Price / Piece Rs.
03.505.01	14/23	90.00
03.505.03	19/26	110.00
03.505.05	24/29	120.00
03.505.06	29/32	130.00
03.505.07	34/35	160.00

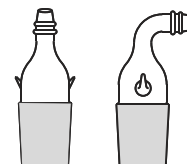

03.505

03.507 Adapters, "RELIGLAS", Cone with stem, rubber tubing Right angle connection.

Cat. No.	Cone	Price / Piece Rs.
03.507.01	14/23	150.00
03.507.03	19/26	170.00
03.507.05	24/29	180.00



03.507

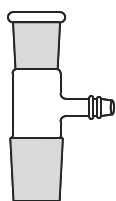

03.511

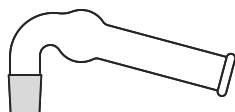

03.515

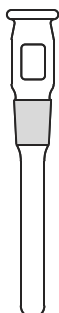

03.517



03.519

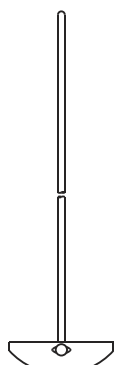

03.525

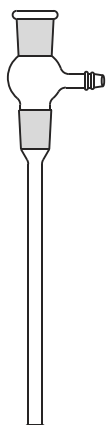

03.531

**03.511 Adapters "RELIGLAS" Socket to cone with Tee Connection.**

Cat. No.	Socket	Cone	Price / Piece Rs.
03.511.01	14/23	19/26	140.00
03.511.03	19/26	19/26	150.00
03.511.05	19/26	24/29	160.00
03.511.07	24/29	34/35	210.00

**Note:** All Adapters at Cat. No. 03.467, 03.471, 03.495, 03.501 to 03.511 for Screw Type Removable Connectors Rs. 40.00 each Extra.

**03.515 Drying Tube, "RELIGLAS".**

Cat. No.	Cone	Price / Piece Rs.
03.515.01	14/23	120.00
03.515.03	19/26	130.00
03.515.05	24/29	150.00
03.515.07	29/32	170.00

**03.517 Thermometer Pocket, "RELIGLAS".**

Cat. No.	Cone	Price / Piece Rs.
03.517.01	14/23	118.00
03.517.03	19/26	128.00
03.517.05	24/29	145.00

**03.519 Air Leak Tube/Gas Inlet Tube, "RELIGLAS".**

Cat. No.	Cone	Price / Piece Rs.
03.519.01	14/23	120.00
03.519.03	19/26	140.00
03.519.05	24/29	160.00
03.519.07	34/35	220.00

❖ **STIRRERS**

**03.525 Teflon Bladed Stirrers, "RELIGLAS", Blade removable from the Stirrer Shaft.**

Cat. No.	Approx. Shaft Dia mm	Shaft Length mm	Smallest Socket through which blade will pass	Blade Width mm	Price / Piece Rs.
03.525.01	6	450	19/26	52	320.00
03.525.03	6	450	24/29	76	400.00
03.525.05	8	450	24/29	76	420.00
03.525.07	8	450	29/32	100	525.00
03.525.09	8	600	34/35	100	550.00
03.525.11	10	450	34/35	100	570.00
03.525.13	10	600	34/35	125	745.00
03.525.15	10	600	50/42	150	850.00

**03.527 Shaft for Teflon Bladed stirrers, "RELIGLAS"**

03.527.17	6	450	125.00
03.527.19	8	450	140.00
03.527.21	8	600	180.00
03.527.23	10	450	190.00
03.527.25	10	600	240.00

**03.531 Stirrers Guides, "RELIGLAS".**

Cat. No.	To fit Stirrer Shaft	Socket	Cone	Approx. Stem Length	Price / Piece Rs.
03.531.01	6 mm	19/26	19/26	200 mm	300.00

**03.535 Stuffing Box Glands, "RELI GLAS", with brass pulley fitted with ball bearing.**

Cat. No.	Material of Cone	To fit Stirrer Shaft	Cone	Price / Piece Rs.
03.535.01	PTFE	6 mm	19/26	2400.00
03.535.03	PTFE	6-8 mm	24/29	2550.00
03.535.04	PTFE	8-10 mm	29/32	2900.00
03.535.05	PTFE	8 mm	34/35	3000.00

**03.539 Simple Glands with Cap, "RELI GLAS".**

Cat. No.	To fit Stirrer Shaft	Cone Fitting Condenser	Price / Piece Rs.
03.539.01	6 mm	14/23	100.00
03.539.03	6 mm	19/26	110.00
03.539.05	6 mm	24/29	120.00

**SEPARATING / DROPPING FUNNELS**

**04.551 Separating Funnel, "RELI GLAS", with glass key Stopcock, Interchangeable Stopper, Conical/Pear Shape, Plain Stem.**

Cat. No.	Capacity ml.	Neck Size	Price / Piece Rs.
04.551.01	25/30	14/23	350.00
04.551.03	50/60	14/23	390.00
04.551.05	100/125	19/26	500.00
04.551.07	250	24/29	640.00
04.551.09	500	24/29	750.00
04.551.11	1000	29/32	1180.00
04.551.13	2000	29/32	2300.00
04.551.15	5000	34/35	9400.00

**04.552 Separating Funnel, "RELI GLAS", AMBER, with glass key Stopcock, Interchangeable Stopper, Conical/Pear Shape, Plain Stem.**

Cat. No.	Capacity ml.	Neck Size	Price / Piece Rs.
04.552.01	25/30	14/23	600.00
04.552.03	50/60	14/23	660.00
04.552.05	100/125	19/26	800.00
04.552.07	250	24/29	950.00
04.552.09	500	24/29	1200.00
04.552.11	1000	29/32	1750.00
04.552.13	2000	29/32	3800.00
04.552.15	5000	34/35	12000.00

Note: Screw type Glass Key retaining provision can be provided @Rs. extra.

**04.553 Separating Funnel, "RELI GLAS", with Screw type, PTFE Needle Valve stopcock, Interchangeable Stopper, Conical/Pear Shape, Plain Stem.**

Cat. No.	Capacity ml.	Neck Size	Price / Piece Rs.
04.553.01	25/30	14/23	325.00
04.553.03	50/60	14/23	360.00
04.553.05	100/125	19/26	480.00
04.553.07	250	24/29	580.00
04.553.09	500	24/29	750.00
04.553.11	1000	29/32	1150.00
04.553.13	2000	29/32	2600.00

**04.554 Separating Funnel, "RELI GLAS", AMBER, with Screw type, PTFE Needle Valve stopcock, Interchangeable Stopper, Conical/Pear Shape, Plain Stem.**

Cat. No.	Capacity ml.	Neck Size	Price / Piece Rs.
04.554.01	25/30	14/23	600.00
04.554.03	50/60	14/23	660.00
04.554.05	100/125	19/26	740.00
04.554.07	250	24/29	920.00
04.554.09	500	24/29	1180.00
04.554.11	1000	29/32	1740.00



03.535



03.539

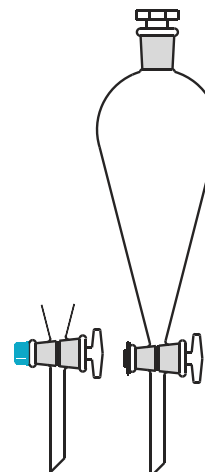

04.551

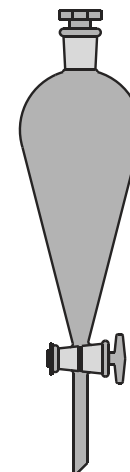

04.552

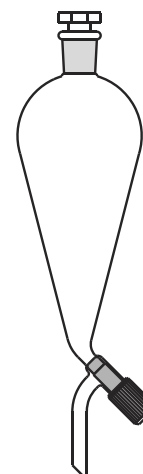

04.553

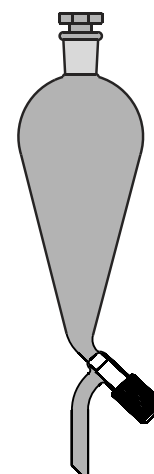

04.554

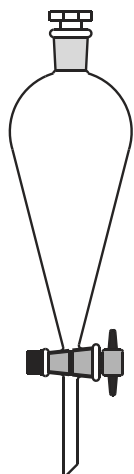

04.555

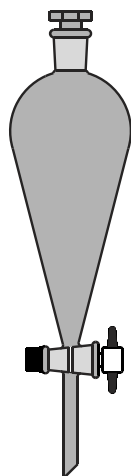

04.556

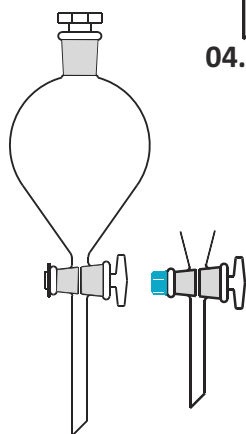

04.557

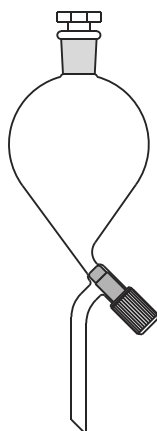

04.559

**04.555 Separating Funnels, "RELIGLAS", with PTFE key Stopcock, Interchangeable Stopper, Conical/Pear Shape, Plain Stem.**

Cat. No.	Capacity ml.	Neck Size	Price / Piece Rs.
04.555.01	25/30	14/23	595.00
04.555.03	50/60	14/23	660.00
04.555.05	100/125	19/26	800.00
04.555.07	250	24/29	890.00
04.555.09	500	24/29	1190.00
04.555.11	1000	29/32	1600.00
04.555.13	2000	29/32	3000.00
04.555.15	5000	34/35	10200.00

**04.556 Separating Funnels, "RELIGLAS", AMBER, with PTFE key Stopcock, Interchangeable Stopper, Conical/Pear Shape, Plain Stem.**

Cat. No.	Capacity ml.	Neck Size	Price / Piece Rs.
04.556.01	25/30	14/23	890.00
04.556.03	50/60	14/23	940.00
04.556.05	100/125	19/26	1050.00
04.556.07	250	24/29	1250.00
04.556.09	500	24/29	1700.00
04.556.11	1000	29/32	2400.00
04.556.13	2000	29/32	4500.00

**04.557 Separating Funnels, "RELIGLAS", with glass key Stopcock, Interchangeable Stopper, Globe Shape, Plain Stem.**

Cat. No.	Capacity ml.	Price / Piece Rs.
04.557.01	25/30	330.00
04.557.03	50/60	370.00
04.557.05	100/125	450.00
04.557.07	250	525.00
04.557.09	500	675.00
04.557.11	1000	1050.00
04.557.13	2000	2200.00
04.557.15	3000	3500.00
04.557.17	5000	5100.00
04.557.19	10000	8900.00
04.557.21	20000	16500.00

**Note :** Screw type Glass Key retaining provision can be provided @ Rs. 80.00 extra.

**04.559 Separating Funnels, "RELIGLAS", with Screw type PTFE Needle Valve Stopcock, Interchangeable Stopper, Globe Shape, Plain Stem.**

Cat. No.	Capacity ml.	Price / Piece Rs.
04.559.01	25/30	320.00
04.559.03	50/60	350.00
04.559.05	100/125	425.00
04.559.07	250	530.00
04.559.09	500	690.00
04.559.11	1000	1120.00
04.559.13	2000	2200.00
04.559.15	3000	3500.00
04.559.17	5000	5300.00

**04.561 Separating Funnels, "RELIGLAS", with PTFE key Stopcock, Interchangeable Stopper, Globe Shape, Plain Stem.**

Cat. No.	Capacity ml.	Price / Piece Rs.
04.561.01	25/30	650.00
04.561.03	50/60	685.00
04.561.05	100/125	750.00
04.561.07	250	950.00
04.561.09	500	1160.00
04.561.11	1000	1600.00
04.561.13	2000	3000.00

**04.565 Dropping Funnels, "RELIGLAS", Cylindrical, with Interchangeable Stopper and Glass Key / Screw type PTFE Stopcock, Plain Stem.**

Cat. No.	Capacity ml.	Price / Piece (Rs.) Glass Key S/C	Price / Piece (Rs.) Screw Type PTFE S/C
04.565.01	50	350.00	350.00
04.565.03	100	390.00	390.00
04.565.05	250	475.00	475.00

Note : Please suffix 'G' for Glasskey Stopcock, 'S' for Screw Type Stopcock while placing your order.

**04.567 Dropping Funnels, "RELIGLAS", Cylindrical, Graduated, with I/C Stopper and Glass Key / Screw type PTFE Stopcock, Plain Stem.**

Cat. No.	Capacity ml.	Price / Piece (Rs.) Glass Key S/C	Price / Piece (Rs.) Screw Type PTFE S/C
04.567.01	50	450.00	450.00
04.567.03	100	490.00	490.00
04.567.05	250	575.00	575.00

Note : Please suffix 'G' for Glasskey Stopcock, 'S' for Screw Type Stopcock while placing your order.

**04.568 Dropping Funnels, "RELIGLAS", Cylindrical, open top, with Glass Key Stopcock, Plain Stem.**

Cat. No.	Capacity ml.	Price / Piece Rs.
04.568.01	25	240.00
04.568.03	50	260.00
04.568.05	100	290.00
04.568.07	250	340.00

**04.571 Dropping Funnels, "RELIGLAS", Cylindrical, open top, with Glass Key / Screw type PTFE Stopcock, Stem with Cone.**

Cat. No.	Capacity ml.	Cone	Price / Piece (Rs.) Glass Key S/C	Price / Piece (Rs.) Screw Type PTFE S/C
04.571.01	50	19/26	320.00	320.00
04.571.03	100	19/26	340.00	340.00
04.571.05	100	24/29	350.00	350.00
04.571.07	250	19/26	460.00	460.00
04.571.09	500	24/29	575.00	575.00

Note : Please suffix 'G' for Glasskey Stopcock, 'S' for Screw Type Stopcock while placing your order.

**04.579 Separating Funnels, "RELIGLAS", Pear shape, with socket, Glass Key /Screw Type PTFE stopcock, stem with cone but without stopper.**

Cat. No.	Capacity ml.	Socket Size	Cone Size	Price / Piece Rs. Glass Key S/C	Price / Piece Rs. Screw Type PTFE S/C
04.579.01	50	14/23	14/23	390.00	390.00
04.579.03	50	19/26	19/26	420.00	420.00
04.579.05	100	19/26	19/26	475.00	475.00
04.579.07	250	19/26	19/26	540.00	540.00
04.579.09	500	19/26	19/26	675.00	675.00
04.579.11	500	24/29	24/29	690.00	690.00

Note : Please suffix 'G' for Glasskey Stopcock, 'S' for Screw Type Stopcock while placing your order.

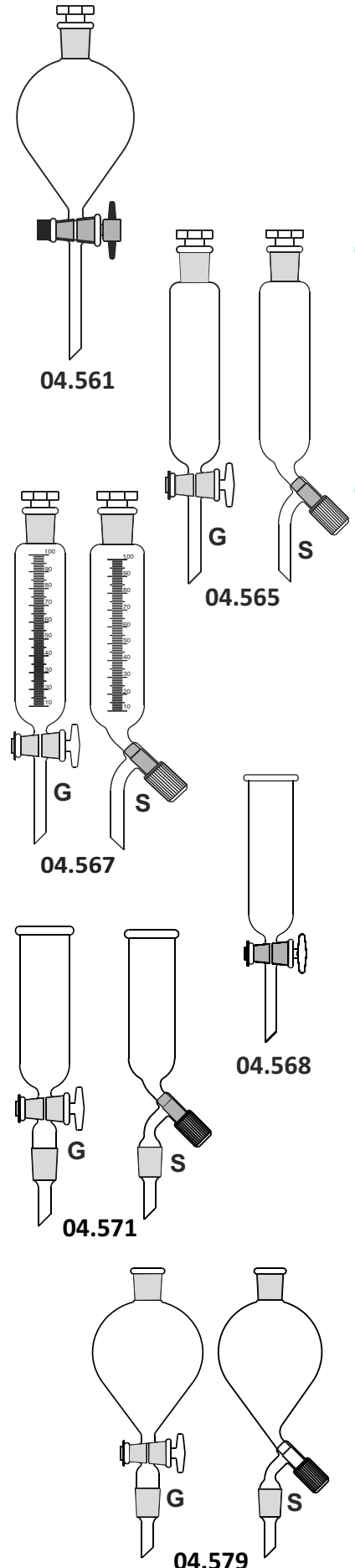

Separating/ Dropping Funnels



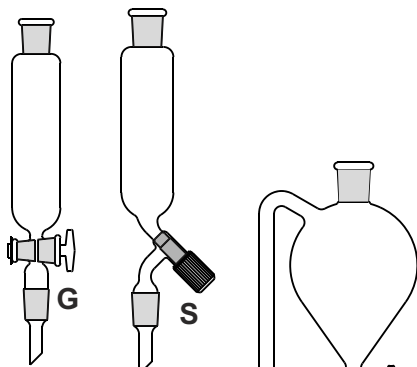

04.581

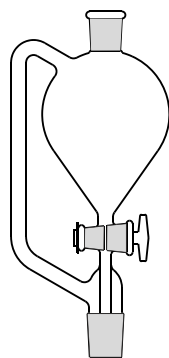

04.585

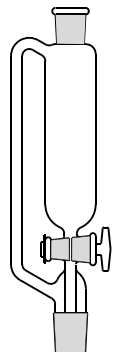

04.587

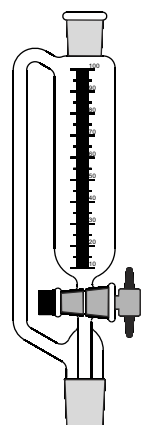

04.588

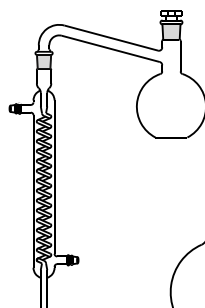

05.601

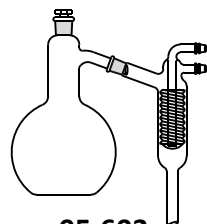

05.603



05.605

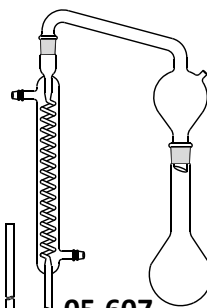

05.607



05.609

04.581 Dropping Funnels, "RELIGLAS", Cylindrical, with socket, Glass Key / Screw type PTFE stopcock, stem with cone but without stopper.

Cat. No.	Capacity ml.	Socket Size	Cone Size	Price / Piece Rs Glass Key S/C	Price / Piece Rs. Screw Type PTFE S/C
04.581.01	50	14/23	14/23	390.00	390.00
04.581.03	50	19/26	19/26	420.00	420.00
04.581.05	100	19/26	19/26	475.00	475.00
04.581.07	250	19/26	19/26	540.00	540.00

Note: Please suffix 'G' for Glasskey Stopcock, 'S' for Screw Type Stopcock while placing your order.

04.585 Pressure Equalizing Funnels, "RELIGLAS", Pear shape, with socket, Glass key / PTFE Key stopcock, stem with cone.

Cat. No.	Capacity ml.	Socket Size	Cone Size	Price / Piece Rs Glass Key S/C	Price / Piece Rs. PTFE Key S/C
04.585.01	100	19/26	19/26	770.00	980.00
04.585.03	100	24/29	24/29	790.00	1020.00
04.585.05	250	19/26	19/26	840.00	1050.00
04.585.07	250	24/29	24/29	875.00	1070.00
04.585.09	500	19/26	19/26	1040.00	1260.00
04.585.11	500	24/29	24/29	1080.00	1290.00

Note: Please suffix 'G' for Glasskey Stopcock, 'P' for PTFE Key Stopcock while placing your order.

04.587 Pressure Equalising Funnels, "RELIGLAS", Cylindrical, with socket, Glass key/ PTFE Key stopcock, stem with cone.

Cat. No.	Capacity ml.	Socket Size	Cone Size	Price / Piece Rs Glass Key S/C	Price / Piece Rs. PTFE Key S/C
04.587.01	50	19/26	19/26	640.00	900.00
04.587.03	100	19/26	19/26	825.00	980.00
04.587.05	250	19/26	19/26	900.00	1050.00
04.587.07	250	24/29	24/29	935.00	1070.00
04.587.09	500	19/26	19/26	1090.00	1320.00
04.587.11	500	24/29	24/29	1135.00	1335.00

Note: Please suffix 'G' for Glasskey Stopcock, 'P' for PTFE Key Stopcock while placing your order.

04.588 Pressure Equalising Funnels, "RELIGLAS", Cylindrical, Graduated with socket, PTFE Key stopcock, stem with cone.

Cat. No.	Capacity ml.	Socket Size	Cone Size	Price / Piece Rs.
04.588.01	50	19/26	19/26	1100.00
04.588.03	100	19/26	19/26	1190.00
04.588.05	250	19/26	19/26	1250.00
04.588.07	250	24/29	24/29	1270.00
04.588.09	500	19/26	19/26	1550.00
04.588.11	500	24/29	24/29	1565.00

## ASSEMBLIES

- 05.601 Distillation Apparatus, "RELIGLAS", Consists of 500 ml Flask, 200 mm. Graham condenser, and stopper. 1600.00
- 05.603 Distillation Apparatus, "RELIGLAS", Consists of 2000 ml Flask, Friedrich condenser and stopper. 3800.00
- 05.605 Distillation Apparatus, "RELIGLAS", compact, Consists of 1000ml Erlenmeyer Flask, and Friedrich condenser. 2950.00
- 05.607 Distillation Apparatus Ammonia, "RELIGLAS", Consists of 500ml Kjeldahl Flask, splash head and Graham condenser. 1700.00

05.609 Reflux Apparatus, consists of RB Flask and Air Condenser.

Cat. No.	Flask Capacity ml	Air Condenser mm	Price / Piece Rs.
05.609.01	100	500	475.00
05.609.03	250	750	490.00
05.609.05	500	100	605.00

05.610 Reflux Apparatus, consists of RB Flask and Leibig Condenser.

Cat. No.	Flask Capacity ml	Liebig Condenser mm	Price / Piece Rs.
05.610.01	100	300	605.00
05.610.03	250	400	695.00
05.610.05	500	500	810.00

05.611 Distillation Assembly, "RELIGLAS", consists of R.B. flask, splash head, double surface condenser and receiver adapter.

Cat. No.	Flask Capacity ml.	Condenser effective length mm	Price / Piece Rs.
05.611.05	2000	200	2450.00
05.611.07	3000	300	3900.00
05.611.09	5000	400	5300.00
05.611.11	10000	600	9500.00

05.615 Distillation Apparatus, "RELIGLAS", consists of R.B. flask, recovery bend, Liebig condenser and receiver adapter.

Cat. No.	Flask Capacity ml.	Condenser effective length mm	Price / Piece Rs.
05.615.05	250	200	895.00
05.615.07	500	300	1070.00
05.615.09	1000	350	1295.00
05.615.11	2000	400	1950.00

- 05.618 Alcohol Distillation Unit with 1000 ml. R.B. Flask 2100.00
- 05.620 Carbaryl Content Determination Apparatus as per IS 4200.00
- 05.621 Sulphur Di-Oxide Assembly as per USP 4500.00
- 05.622 Methoxy Determination Assembly as per USP 8100.00
- 05.623 Fluoride Determination as per I.S. 3900.00
- 05.624 Cyanide Distillation Apparatus 3700.00
- 05.625 Mancozeb Content Determination Assembly as per IS 6000.00
- 05.626 Hydroxypropoxy Determination Assembly as per USP 7800.00
- 05.626A Alkoxy and Alkylimino group determination app. (Micro Zeisel) 2400.00
- 05.626B Micro Acetyl group determination apparatus (Wiesenberg) 7500.00

❖ **EXTRACTORS**

05.631 Soxhlet Extraction, "RELIGLAS", consists of Flask, Extractor and Condenser.

Cat. No.	Extractor Cap. (ml)	Extractor Socket	Extractor Cone	Flask Cap. (ml)	Price / Piece Rs.
05.631.05	60	34/35	24/29	150	1250.00
05.631.09	100	40/38	24/29	250	1400.00
05.631.11	200	50/42	24/29	500	2000.00
05.631.13	400	50/42	24/29	1000	2900.00
05.631.15	600	50/42	24/29	2000	3600.00
05.631.17	1000	55/42	34/35	3000	6250.00

05.633 Spare Extractor, "RELIGLAS", for Soxhlet. Cat No. 05.631

Cat. No.	Capacity (ml)	Socket	Cone	Price / Piece Rs.
05.633.05	60	34/35	24/29	700.00
05.633.09	100	40/38	24/29	750.00
05.633.11	200	50/42	24/29	1100.00
05.633.13	400	50/42	24/29	1450.00
05.633.15	600	50/42	24/29	1670.00
05.633.17	1000	55/44	34/35	2550.00

05.637 Soxhlet Extraction, "RELIGLAS", consisting RB Flask, Extractor with flange, reduction adapter with flat flange and socket and double surface Condenser.

Cat. No.	Extractor Capacity ml.	Flask Capacity ml	Price / Piece Rs.
05.637.01	600	2000	10500.00
05.637.03	1000	3000	14000.00
05.637.05	2000	5000	17500.00
05.637.07	3000	10000	19800.00

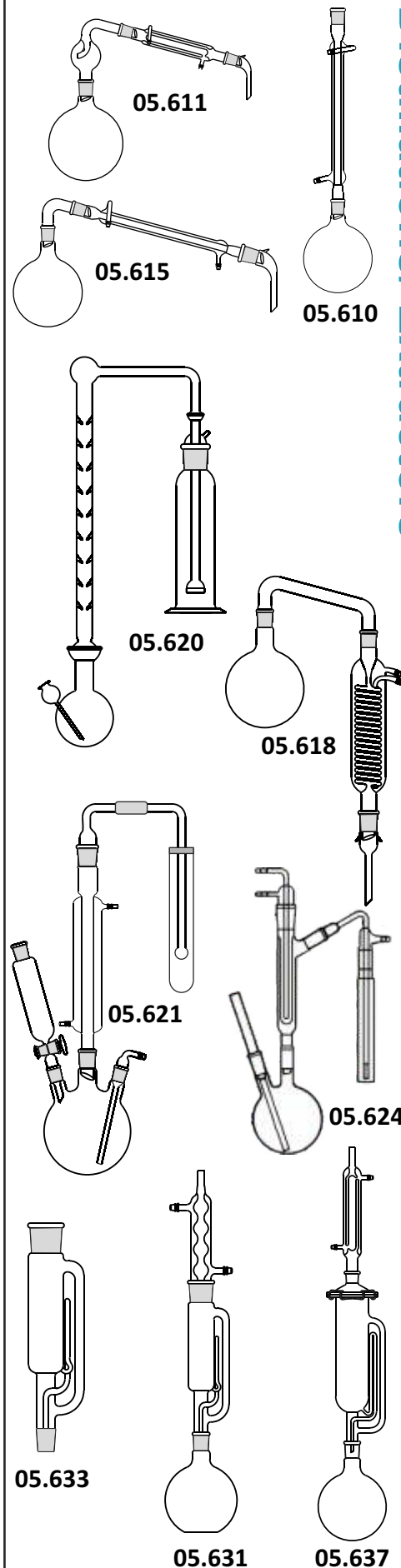

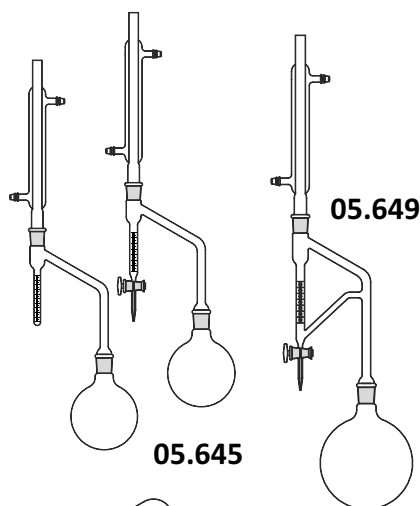

05.645

05.649

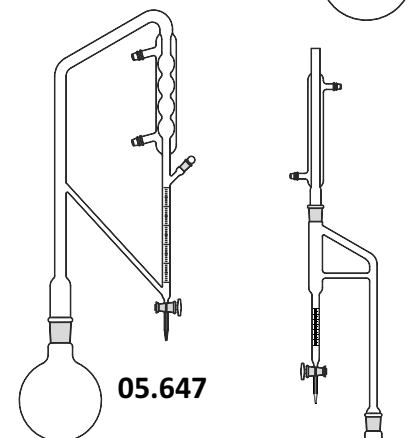

05.647

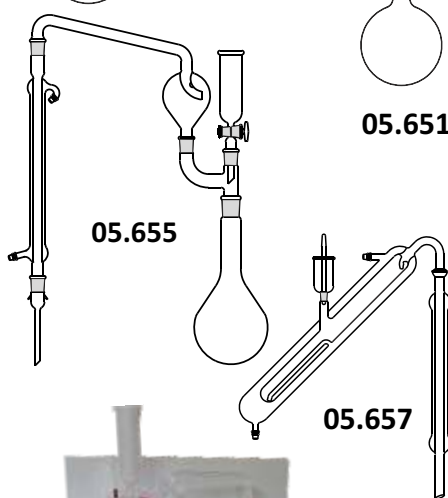

05.651

05.655

05.657



05.656

**05.645** Moisture Determination Unit, "RELIGLAS", (Dean & Stark), comprises of round bottom flask, receiver and Liebig condenser.

Cat. No.	Type	Price / Piece (Rs.)
05.645.01	2ml Receiver with stopcock, 250ml Flask	1500.00
05.645.03	5ml Receiver with stopcock, 500ml Flask	1700.00
05.645.05	10ml Receiver with stopcock, 1000ml Flask	1900.00
05.645.06	25ml Receiver with stopcock, 1000ml Flask	2100.00
05.645.08	2ml Receiver without stopcock, 250ml Flask	1350.00
05.645.09	5ml Receiver without stopcock, 500ml Flask	1500.00
05.645.10	10ml Receiver without stopcock, 1000ml Flask	1700.00
05.645.11	25ml Receiver without stopcock, 1000ml Flask	1900.00
05.645.15	Spare receiver with stopcock, 2/ 5/ 10/ 25ml	850.00
05.645.20	Spare receiver without stopcock 2/ 5/ 10/ 25ml	700.00

**Note:** For Class 'A' NABL certificates for above receivers Rs. 400.00 Extra.

**05.647** Essential Oil Determination Unit, "RELIGLAS" (Clevenger Type) Vertical tube combined with condenser and measuring tube with stopcock. A return tube for the aqueous part of the distillate connects the bottom of the measuring tube and the vertical tube.

Cat. No.	Flask Capacity ml.	Price / Piece Rs.
05.647.01	1000	2750.00
05.647.03	2000	3050.00
05.647.05	3000	5500.00
05.647.07	5000	6900.00
05.647.09	10000	11750.00
05.647.11	20000	19500.00

**05.649** Clevenger Assembly, "RELIGLAS" for determination of volatile oil lighter than water, comprising of 1000 ml flask, oil separatory tube and condenser. **2050.00**

**05.649.01** Spare Oil Separatory Tube **990.00**

**N-649** Clevenger Assembly, "RELIGLAS" for determination of volatile oil lighter than water, comprising of 1000 ml flask, oil separatory tube and condenser, Class 'A' with NABL Certificate **2500.00**

**N. 649.01** Spare Oil Separatory Tube, Class 'A', with NABL Certificate **1390.00**

**05.651** Clevenger Assembly, "RELIGLAS" for determination of volatile oil heavier than water, comprising of 1000 ml. flask, oil separatory tube and condenser. **2050.00**

**05.651.01** Spare Oil Separatory Tube **990.00**

**N.651** Clevenger Assembly, "RELIGLAS" for determination of volatile oil heavier than water, comprising of 1000 ml flask, oil separatory tube and condenser., Class 'A' with NABL Certificate **2500.00**

**N. 651.01** Spare Oil Separatory Tube, Class 'A', with NABL Certificate. **1390.00**

**05.655** Kjeldahl Distillation Assembly, "RELIGLAS", consists of Kjeldhal flask 500 ml., multiple adapter two necks, splash head vertical, Liebig condenser, receiver adapter and dropping funnel 100 ml. **2400.00**

**05.656** Kjeldhal Distillation Unit on Stand with Heating arrangement with Quartz Tube Heater. **49500.00**

**05.657** Markham Semi Micro Distillation Unit, "RELIGLAS"

Cat. No.	Description	Price / Piece Rs.
05.657.01	Comprising of Markham still body with enclosed evaporator vessel in a combined steam jacket and trap, funnel plug, condenser and spherical joint clip.	2800.00
05.657.03	Comprising similar parts but with conical joints instead of spherical joints.	2350.00

- 05.659 **Micro Kjeldhal Nitrogen Distillation Assembly** (Pregal, Parnes and Wagner App.) complete with 1 ltr. Steam Flask, Glass Condenser, Vacuum Jacket, Stand & Clamps etc., without burner. 6700.00
- 05.659.02 **Micro Kjeldhal Nitrogen Distillation Assembly** with 2 ltr. Steam Flask 7400.00
- 05.659.05 **Vacuum Jacket only** 1600.00

### WATER DISTILLATIONS

- 05.671 **“RELIGLAS” Water Still Metal Heater** comprises of a Horizontal Borosilicate glass boiler fitted with a 3KW chromium plated immersion heater with thermostat, double coil high efficiency condenser ensure a reliable output of single distillate. The still is fitted on a sheet metal epoxy coated stand, suitable for bench or wall mounting. For use on 220/240 V. 50/60 Hz single phase supply. As per picture. **Distillate Output** : 4 Liters/hr Approx, pH : 5 to 6.5 Pyrogen free. 23900.00

**Note :** ph, conductivity and sensitivity are affected by temperature and the presence of absorbed carbon dioxide. The basis of tests are at 20° C on distilled water free of carbon dioxide. Care is needed to obtain Pyrogen free water and the distillate must be tested before use. Pre treated input water (use of softener) is recommended for obtaining better results and to increase the still life.

**Spares :**

- 05.671.01 Boiler for Water Still 9800.00
- 05.671.03 Condenser for Water Still 6000.00
- 05.671.05 Heater 3KW fitted with thermostat 6000.00

**Note:** For installation charges, refer Cat. No. 05.697

- 05.675 **“RELIGLAS” Water Still (U-Tube Heater)** are carefully designed to produce high purity pyrogen free distilled water. The water still comprises of borosilicate glass horizontal type boiler, coil condenser, constant level device, Quartz U-Tube heaters, along with stand and clamps. All parts are replaceable. **pH/Conductivity** : 6-7 / 1-2 µS/cm for single, 6-7/0.8-1 µS/cm for double distilled water. with built-in safety cutoff device, which protects the glass in case of water supply failure and over heating

Cat. No.	Stage	Approx. Output	Wattage	Price / Piece Rs.
05.675.02	Single	1.5 Ltr. /Hr.	1.50 KW	27400.00
05.675.04	Single	2.5 Ltr. /Hr.	1.70 KW	31000.00
05.675.06	Double	1.5 Ltr. /Hr.	3.0 KW	41000.00
05.675.08	Double	2.5 Ltr. /Hr.	3.4 KW	48000.00
05.675.09	Single	4 Ltr. /Hr.	3.3 KW	38000.00
05.675.11	Double	4 Ltr. /Hr.	6.6 KW	75000.00
05.675.40	Single	8 Ltr. /Hr.	6.6 KW	105000.00
05.675.45	Double	8 Ltr. /Hr.	13.5 KW	170000.00

**Spare Parts :**

05.675.13	Constant level device	950.00
05.675.14	Boiling chamber for 1.5 Lt./Hr. Still	7500.00
05.675.16	Boiling chamber for 2.5 Lt./Hr. Still	7800.00
05.675.17	Boiling chamber for 4 Lt./Hr. Still	11500.00
05.675.18	Boiling chamber for 8 Lt./Hr. Still	26000.00
05.675.19	Coil Condenser for 1.5 Lt./Hr. Still	5200.00
05.675.20	Coil Condenser for 2.5 Lt./Hr. Still	6000.00
05.675.21	Coil Condenser for 4 Lt./Hr. Still	7400.00
05.675.22	Coil Condenser for 8 Lt./Hr. Still	14000.00
05.675.23	U-Tube Quartz heater 1.7 KW with Silicon Stopper	5250.00
05.675.24	U-Tube Quartz heater 3.4 KW with Silicon Stopper	7200.00
05.675.29	Water Softner to enhance life of Water Still (Recommended)	15500.00
05.675.31	Reverse Osmosis Unit 5 stage purification (for removal of 80-90% salts). Recommended where the salts are more in raw water.	32000.00

**Note:** For installation charges, refer Cat. No. 05.697

- 05.677 **Heat Exchanger for Water Distillations and Stills (Chiller)** 82000.00  
Hot water from the condenser outlet is cooled and recirculated in the condenser, thus savings the wate wastage. Power consumption 375 watts.)

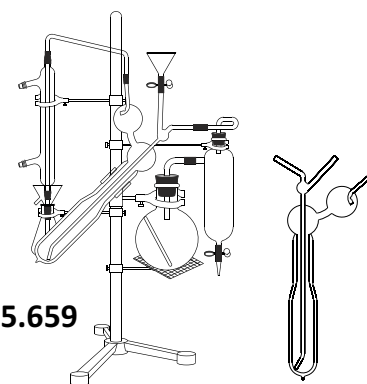

05.659

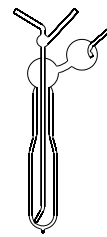

05.659.05



05.671



05.675



05.677

## 05.679 Automatic Water Distillation Equipment (Cabinet Model)

### Compact & User Friendly

- This is a fully automatic water distillation equipment has been designed for better and accurate control of the distillation unit and can be used in research laboratories, hospitals etc.
- It has been incorporated with advanced microprocessor based electronic circuitry.
- The alpha numeric LCD which has been used shows all messages that correspond to the running of the machine.
- Also there is alarm system which beeps as and when user attention is required.

### The distillation has following features:

- Replaceable silica sheathed (Quartz) heater: The horizontal quartz jacket is fitted with removable silica heater and screw threaded connectors for ease of cleaning when scaling is formed.
- Cooling water from the condenser is re-circulated into the boiling chamber, hence saving energy.
- Boiler is provided with a Replaceable Side over Flow for easy draining and cleaning of boiling chamber, which also reduces the chances of breakage.
- The front cover is easily removable making the access to the glass parts very easy.
- Electrical Power: 220/240 V, 50/60Hz, Single Phase Supply.

### Additional In-built Safety Features:

- Gate Valve: Conserves cooling water wastage in case of power failure.
- Flow Switch: Additional in-built safety feature for the equipment unit shut off in case of cooling water failure.
- Temperature switch: The boiler is equipped with a safety temperature switch which shuts off the unit if water level in the boiler falls below the heater, thus saving the glass parts from any damages.
- Reservoir Level Sensor: This helps in automatic working of the water distillation equipment. Depending on the water level in the reservoir it will automatically switch On/Off the equipment, thus saving energy. (Reservoir can also be provided with a storage capacity of 5 ltr, 10 ltr & 20 ltr made of Borosilicate Glass or polypropylene at an extra cost)



05.679

### 05.679 Technical Specifications:

Cat. No.	Output Ltr./Hr.	Stage	Price / Piece Rs.
05.679.01	2	Single	74800.00
05.679.03	2	Double	110400.00
05.679.05	4	Single	93500.00
05.679.07	4	Double	144500.00

### Distillate Quality:

Output Capacity: 2 Ltr./Hr.

pH : 5.5-6.0  
 Conductivity ( $\mu\text{s}/\text{cm}$ ) : <3.0  
 Cooling Water Requirement : 1.5 Ltr./Min.  
 Power Rating : 1.5 kW

Output Capacity: 4 Ltr./Hr.

pH : 5.5-6.0  
 Conductivity ( $\mu\text{s}/\text{cm}$ ) : <3.0  
 Cooling Water Requirement : 2.5 Ltr./Min.  
 Power Rating : 3.0 kW

- Note:
- Output quality would depend upon the quality of the inlet feed water to the boiler.
  - For high purity & low conductivity water we recommend quartz water distillations.
  - All parameters are under standard test conditions

05.681 "RELIGLAS" All glass Distillation Unit N.P.L. Design (Flask type), with heater embedded in spiral glass tube complete with stand, clamps, cord, etc.

Cat. No.	Flask Capacity	Stage	Safety Cutoff	Price / Piece Rs.
05.681.01	3 Litre	Single	✗	16500.00
05.681.03	3 Litre	Single	✓	22500.00
05.681.05	5 Litre	Single	✗	17000.00
05.681.07	5 Litre	Single	✓	20000.00
05.681.09	10 Litre	Single	✗	21500.00
05.681.11	10 Litre	Single	✓	23800.00
05.681.13	3 Litre	Double	✗	32000.00
05.681.15	3 Litre	Double	✓	33250.00
05.681.17	5 Litre	Double	✗	33000.00
05.681.19	5 Litre	Double	✓	35500.00
05.681.21	10 Litre	Double	✗	43000.00
05.681.23	10 Litre	Double	✓	44000.00
05.681.25	3 Litre	Triple	✗	46500.00
05.681.27	3 Litre	Triple	✓	48500.00
05.681.29	5 Litre	Triple	✗	49500.00
05.681.31	5 Litre	Triple	✓	51000.00
05.681.33	10 Litre	Triple	✗	61500.00
05.681.35	10 Litre	Triple	✓	64000.00

**Spare Parts :**

05.681.37	Flask with heater 3 Litre	8500.00
05.681.39	Flask with heater 5 Litre	9400.00
05.681.41	Flask with heater 10 Litre	13500.00
05.681.43	Condenser for 3 Litre Distillation with 40/38 Cone	3000.00
05.681.45	Condenser for 5 Litre Distillation with 40/38 Cone	3150.00
05.681.47	Condenser for 10 Litre Distillation with 50/42 Cone	3400.00
05.681.49	Safety cut off for Single Stage Distillation	8000.00
05.681.51	Safety cut off for Double Stage Distillation	8400.00
05.681.53	Safety cut off for Triple Stage Distillation	9300.00
05.681.55	Receiving tube for condenser	575.00
05.681.57	Stand for single distillation for 3, 5 or 10 liters flask	2750.00
05.681.59	Stand for Double Distillation	5500.00
05.681.61	Water Softener to enhance life of Water Distillation (Recommended)	15500.00
05.681.63	Reverse Osmosis Unit 5 stge purification (for removal of 80-90% salts) Recommended where the salts are more in raw water.	32000.00

05.683 "RELIGLAS" Mono Quartz Distiller (Horizontal) : Designed for reliable continuous operation, easy use, safe to operate. Comprises of Horizontal Quartz Boiler. Borosilicate / Quartz condenser detachable side constant level device, replaceable silica sheathed heater / heaters, mounted of epoxy coated sheet metal stand, supplied with safety cutoff device, cord & plugs etc.

**Product** : Pyrogen free water,

**Conductivity** : 0.5 – 1.0mS/cm (Quartz), 1.0–1.5ms/cm (Borosilicate)

Cat. No.	Condenser Material	Approx. Output	Wattage	Price / Piece Rs.
05.683.01	Borosilicate	2 ltr./hr.	1.75 KW	59000.00
05.683.03	Quartz	2 ltr./hr.	1.75 KW	81000.00
05.683.05	Borosilicate	5 ltr./hr.	4 KW	66500.00
05.683.07	Quartz	5 ltr./hr.	4 KW	118000.00

**Spare Parts :**

05.683.15	Quartz Boiler for 2 Ltr. Water Still 05.683.01 & 05.683.03	28000.00
05.683.17	Quartz Boiler for 5 Ltr. Water Still 05.683.05 & 05.683.07	42000.00
05.683.19	Condenser, Borosilicate, for 2 Ltr. Water Still 05.683.01	3700.00
05.683.21	Condenser, Borosilicate, for 5 Ltr. Water Still 05.683.05	5100.00
05.683.23	Condenser, Quartz, for 2 Ltr. Water Still 05.683.03	29000.00
05.683.25	Condenser, Quartz, for 5 Ltr. Water Still 05.683.07	42000.00
05.683.27	Quartz U-Tube Heater for Water Still 05.683.01 & 05.683.03	5250.00
05.683.29	Quartz U-Tube Heater for Water Still 05.683.05 & 05.683.07	7200.00

Note: For installation charges, refer Cat. No. 05.697

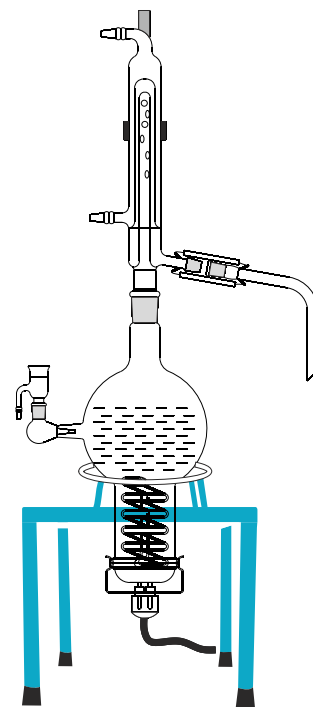

05.681



05.683



05.685

**05.685 "RELIGLAS" Mono Quartz Distiller (Vertical)** : Mono Quartz Distillers are compact. The boiler is made of high purity quartz and the condenser is of Borosilicate / Quartz material. The built in coil type heater provides for minimum loss of heat and production of distilled water starts within 2-3 minutes. The unit is mounted on a sheet metal, epoxy coated stand with electrical connections and easy to assemble.

**Distillate conductivity** : 0.5-1.0  $\mu\text{S/cm}$  (Quartz Condenser)  
1.0-1.5  $\mu\text{S/cm}$  (Borosilicate Condenser)  
pH : 6-7, Biological activity : Pyrogen Free.

Cat. No.	Condenser Material	Approx. Output	Safety Cutoff	Wattage	Price / Piece Rs.
05.685.01	Borosilicate	2.5 ltr./hr.	✗	2 KW	39000.00
05.685.03	Quartz	2.5 ltr./hr.	✗	2 KW	59400.00
05.685.05	Borosilicate	2.5 ltr./hr.	✓	2 KW	50500.00
05.685.07	Quartz	2.5 ltr./hr.	✓	2 KW	81500.00
05.685.09	Borosilicate	5 ltr./hr.	✗	4 KW	65000.00
05.685.11	Quartz	5 ltr./hr.	✗	4 KW	107500.00
05.685.13	Borosilicate	5 ltr./hr.	✓	4 KW	78000.00
05.685.15	Quartz	5 ltr./hr.	✓	4 KW	120000.00

**Water Distillation Unit Spares :**

05.685.17	Quartz Boiler for 2.5 Lt./Hr. Dist.	28000.00
05.685.19	Quartz Boiler for 5 Lt./Hr. Dist.	43500.00
05.685.21	Borosilicate Condenser for 2.5 Lt./Hr. Dist.	5100.00
05.685.23	Borosilicate Condenser for 5 Lt./Hr. Dist.	9800.00
05.685.25	Quartz Condenser for 2.5 ltr. / hr., Distillation	28000.00
05.685.27	Quartz Condenser for 5 ltr. / hr., Distillation	45000.00
05.685.29	Safety Cutoff Device for 2.5 ltr/hr Distillation	11500.00
05.685.31	Safety Cutoff Device for 5 ltr/hr Distillation	12900.00

**05.691 "RELIGLAS" All Quartz Double Distillation Unit** is made from imported fused quartz tubes. The high chemical purity and low solubility of quartz tubing enables the production of high purity distilled water. The unit comprises of two parts : Lower Boiler with built-in spiral heater, cup shaped joint on top and constant level device. Upper Boiler provided with built-in spiral heater. It also has double walled condensing unit which ensures separate condensation of vapors from both the boilers. This portion also has a ball shaped joint which rests on the cup of the lower boiler. The whole unit is mounted on epoxy coated sheet metal stand with electrical fittings. Supplied with safety cut-off device.

**Double Distillate Quality:**

**Conductivity:** 0.5-1.0  $\mu\text{S/cm}$       **Organic Matter:** Nil      **Silica:** <0.01 mg/ltr

**Total Solids:** 0.1 mg/ltr      **Biological activity:** Pyrogen Free.

Cat. No.	Material & Stage	Approx. Output	Wattage	Price / Piece Rs.
05.691.01	All Quartz Double	1.5 lt./Hr.	3 KW	122000.00
05.691.03	All Quartz Double	2.5 lt./Hr.	5 KW	185000.00
05.691.05	All Quartz Double	4 lt./Hr.	8 KW	298000.00
05.691.06	All Quartz Double	5 lt./Hr.	9 KW	341000.00
05.691.08	Lower Boiler	1.5 lt/Hr	1.5KW	28500.00
05.691.10	Lower Boiler	2.5 lt/Hr	2.5KW	36000.00
05.691.12	Lower Boiler	4 lt/Hr	4KW	54000.00
05.691.14	Lower Boiler	5 lt/Hr	5KW	65000.00
05.691.16	Upper Boiler	1.5 lt/Hr	5KW	98500.00
05.691.18	Upper Boiler	2.5 lt/Hr	5KW	140000.00
05.691.20	Upper Boiler	4 lt/Hr	5KW	245000.00
05.691.22	Upper Boiler	5 lt/Hr	5KW	275000.00

**Optional Accessories :**

- 05.691.17 **Flow Switch** : In-built safety feature for the equipment. Shuts off the power supply in case of cooling water supply failure      **18000.00**
- 05.695.01 **Water Softner** to enhance life of Water Still (Recommended)      **15500.00**
- 05.695.03 **Reverse Osmosis Unit** 5 stage purification (for removal of 80-90% salts) Recommended where the salts are more in raw water.      **32000.00**

**Note :** For installation charges, refer Cat. No. 05.697

**05.697 Installation Charges**

For Distance upto 500 kms

5000.00

For Distance between 500 to 1000 kms

7500.00

For Distance more than 1000 kms

12500.00



05.691

## 05.693 All Quartz Double Distillation (Horizontal Model)

### Features

- **Replaceable Silica Heater:** The horizontal quartz jacket is fitted with removable silica heater and screw threaded connectors for ease of cleaning.
- Distillate temperature is approx. between 25° to 45° C which is ensured by an efficient condenser.
- The stand is powder coated for rust free operation and lustrous appearance.
- Cooling water from the condenser is re-circulated into the boiling chamber, hence saving energy.
- Screw Threaded Connectors : These are provided for easy plumbing & Installation to avoid any glassware breakage during assembly.
- Boiler is provided with Replaceable Constant Level Device for easy draining and cleaning of boiling chamber.

### Additional In-built Safety Features

- Gate Valve : Conserves cooling water wastage in case of power failure.
- Flow Switch : In-built safety feature for the equipment unit shut off in case of cooling water failure.
- Temperature switch : The boiler is equipped with a safety temperature switch which shuts off the unit if water level in the boiler falls below the heater, thus saving the glass parts from any damages.

### Double Distillate Quality:

Parameter	Values
Specific Conductivity	0.1 - 0.5 $\mu$ s/cm
Biological Activity	Pyrogen Free
pH	6.9 - 7
Organic Matter	Nil
Total Solids	0.1 mg/ltr
Silica	<0.01 mg/ltr

### 05.693 Technical Specifications:

Cat. No.	Output Ltr/Hr (Approx.)	Power Rating (kW)	Cooling Water Consumption	Price / Piece Rs.
05.693.01	1.5	3	50 ltr/min	165000.00
05.693.03	2.5	5	70 ltr/min	229000.00
05.693.05	4	7*	120 ltr/min	338000.00

\* Three Phase

- Note:
- Output quality would depend upon the quality of the inlet feed water to the boiler.
  - For high purity & low conductivity water we recommend quartz water distillations.
  - All parameters are under standard test conditions



05.693



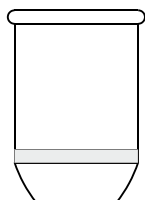

06.701

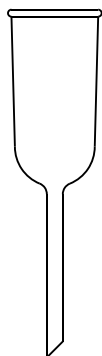

06.703

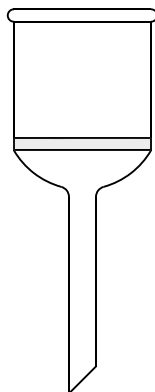

06.705

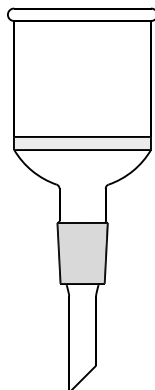

06.707

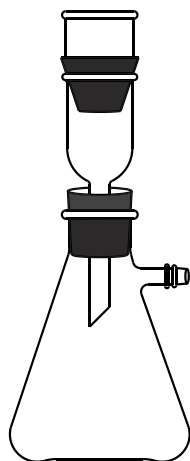

06.709

## SINTERED GLASSWARE (Filtration)

### POROSITY GRADES AND THEIR GENERAL USE

Porosity Grade	Pore Size	General Use
G-0	150-250	Coarse Filtration, Gas dispersion and support for other filter material.
G-1	90-150	Coarse Precipitate, Filtration, Gas dispersion, Coarse grain material filtration.
G-2	40-90	Medium & Crystalline precipitate filtration, medium filtration & washing of gases.
G-3	15-40	Fine Gas filtration and dispersion, mercury filtration, fine grain material filtration, collection of fine precipitates, Analytical Work with medium precipitates.
G-4	5/15	"Valves for mercury collection of very fine precipitates. Analytical work with fine precipitate".

**06.701 Crucible, "RELIGLAS", Gooch type with Sintered Disc of Porosity G-1 or G-2 or G-3 or G-4. Please mention Porosity of Sintered Disc, while ordering.**

Cat. No.	Capacity (ml)	Price/Pc. (Rs.)
06.701.05	15	110.00
06.701.10	30	120.00
06.701.15	50	230.00
06.701.20	Rubber Cone for 15/ 30ml	34.00
06.701.25	Rubber Cone for 50ml	50.00

**06.702 Crucible, "RELIGLAS", Gooch type with 40/26 cone, Sintered Disc of Porosity G-1 or G-2 or G-3 or G-4. Please mention Porosity of Sintered Disc, while ordering.**

Cat. No.	Capacity (ml)	Price/Pc. (Rs.)
06.702.15	50	600.00

**06.703 Adapter, "RELIGLAS", for Gooch Crucible**

Cat. No.	Dia x Ht. mm.	Stem mm.	Suitable for Crucible ml.	Price / Piece Rs.
06.703.05	31 x 60	75 x 9	15	80.00
06.703.10	40 x 68	75 x 9	30	90.00
06.703.15	47 x 78	75 x 9	50	125.00

**06.705 Buchner Funnel, "RELIGLAS", with Sintered Disc of Porosity G-1 or G-2 or G-3 or G-4, plain stem. Please mention Porosity of Sintered Disc, while ordering.**

Cat. No.	Capacity (ml)	Disc Dia (mm)	Price / Pc (Rs.)
06.705.05	35	30	220.00
06.705.10	80	40	360.00
06.705.12	125	50	600.00
06.705.15	200	65	800.00
06.705.20	500	90	1800.00
06.705.25	1000	120	4200.00
06.705.30	2000	145	11000.00

**06.707 Buchner Funnel, "RELIGLAS", with Sintered Disc of Porosity G-1 or G-2 or G-3 or G-4, cone at stem.**

Cat. No.	Capacity ml.	Disc Dia mm.	Cone	Price / Piece Rs.
06.707.05	35	30	14/23 or 19/26	385.00
06.707.10	80	40	14/23 or 19/26	530.00
06.707.12	125	50	19/26 or 24/29	820.00
06.707.15	200	65	19/26 or 24/29	990.00
06.707.20	500	90	24/29 or 29/32	2150.00
06.707.25	1000	120	24/29 or 29/32	5200.00
06.707.30	2000	145	24/29 or 29/32	12700.00

**Note :** Please mention Porosity of Sintered Disc and cone size, while placing order. Other sizes of cones can also be fitted at stem, on same prices.

**06.709 Filter Apparatus, "RELIGLAS", Complete with Filtering Flask, gooch crucible with Sintered Disc of Porosity G-1 or G-2 or G-3 or G-4, glass adapter and rubber cone. Please mention Porosity of Sintered Disc, while ordering.**

Cat. No.	Flask Capacity ml.	Crucible Capacity ml.	Price / Piece Rs.
06.709.05	250	30	670.00
06.709.10	500	30	775.00
06.709.15	1000	50	1230.00

06.711 Filter Apparatus, "RELIGLAS", Complete, Filter Flask with Socket and Buchner funnel with Sintered Disc of Porosity G-1 or G-2 or G-3 or G-4, having cone at stem. Please mention Porosity of Sintered Disc, while placing order.

Cat. No.	Flask Capacity ml.	Buchner Funnel Capacity ml.	Joint	Price / Piece Rs.
06.711.05	250	80	24/29	1040.00
06.711.10	500	200	24/29	1440.00
06.711.15	1000	500	29/32	3050.00
06.711.20	2000	1000	29/32	7000.00

06.713 Filtering Apparatus Witt's, "RELIGLAS", Complete with flanged jar, flanged lid, funnel and 250 ml. beaker. 5200.00

06.721 Membrane Filter Holder Assembly, "RELIGLAS", with support for membrane, Funnel, Flask and Clamp, Standard Joint Fitting.

Cat. No.	Membrane dia mm	Funnel Capacity ml.	Flask Capacity ml.	Price / Piece Rs.
06.721.05	13	35	250	2200.00
06.721.10	25	50	500	2800.00
06.721.15	47	300	1000	4600.00
06.721.20	47	300	2000	5400.00
06.721.25	47	300	5000	8500.00
06.721.35	90	1000	5000	39000.00

Spares for 06.721

Cat. No.	Description	Price/Pc. (Rs.)
06.722		
06.722.05	Flask Capacity 250 ml with 24/29 cone	600.00
06.722.10	Flask Capacity 500 ml with 29/32 cone	850.00
06.722.15	Flask Capacity 1000 ml with 40/42 cone	1350.00
06.722.20	Flask Capacity 2000 ml with 40/42 cone	2100.00
06.722.25	Flask Capacity 5000 ml with 40/42 cone	6700.00
06.723		
06.723.05	Sintered part for 06.721.05, 13mm	1200.00
06.723.10	Sintered part for 06.721.10, 25mm	1250.00
06.723.15	Sintered part for 06.721.15 to 06.721.25, 47mm	2100.00
06.723.35	Sintered part for 06.721.35, 90mm	28000.00
06.724		
06.724.05	Spare Funnel, 35ml	600.00
06.724.10	Spare Funnel, 50ml	700.00
06.724.15	Spare Funnel, 300ml	900.00
06.724.35	Spare Funnel, 1000ml	4800.00

06.725 Membrane Filter Holder Assembly, "RELIGLAS", with support for membrane, Funnel, Flask and Clamp, Neoperene Rubber Cork fitting.

Cat. No.	Membrane dia mm	Funnel Capacity ml.	Flask Capacity ml.	Price / Piece Rs.
06.725.05	13	35	250	2300.00
06.725.10	25	35	500	2400.00
06.725.15	47	300	1000	4400.00
06.725.20	47	300	2000	4900.00
06.725.25	47	300	5000	7000.00

06.726 Spares for 06.725

Cat. No.	Description	Price/Pc. (Rs.)
06.726.05	Sintered Part with Rubber Cork, 13mm	1100.00
06.726.10	Sintered Part with Rubber Cork, 25mm	1150.00
06.726.15	Sintered Part with Rubber Cork, 47mm	1950.00

Note: For spare flasks of 06.725, refer 02.323

06.729 Filter Holders, Stainless Steel (To hold Membrane Filters) without flask.

Cat. No.	Description	Price / Piece Rs.
06.729.05	Syringe Filter Holder for 13 mm membrane	POR
06.729.10	Syringe Filter Holder for 25 mm membrane	POR
06.729.15	Vacuum Filter Holder for 47 mm w/o Flask	6800.00
06.729.20	3 Branch Sterility Test, for 47 mm, membrane	46800.00
06.729.25	6 Branch Sterility Test, for 47 mm, membrane	90000.00

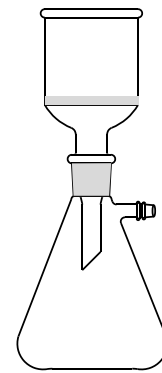

06.711

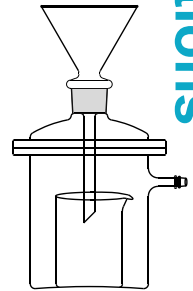

06.713

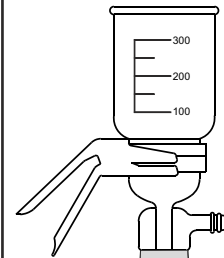

06.721

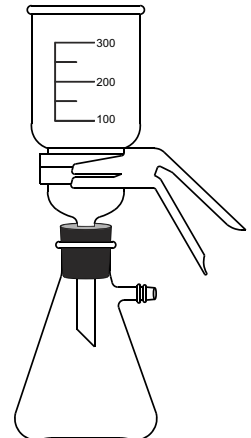

06.725

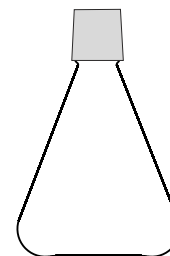

06.722



06.729.15

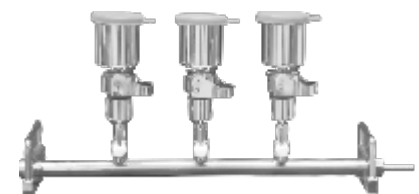

06.729.20



06.630.05



06.630.11



06.731/ 06.732

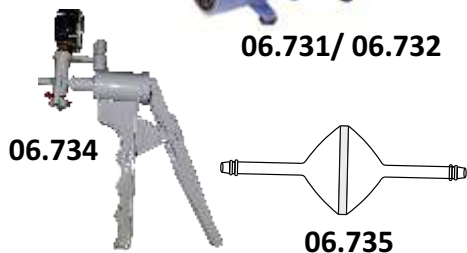

06.734

06.735

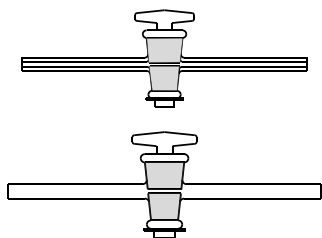

07.741

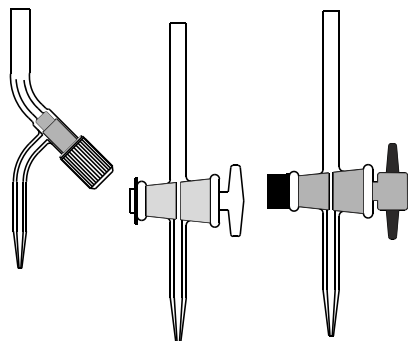

07.745

**06.730 Filter Assemblies, "RELIGLAS", complete set with Vacuum Pump and other accessories. (SS & Glass)**

Cat. No.	Description	Price / Piece Rs.
06.730.01	Membrane Filtration Assembly Glass: 250ml Funnel Sintered Base with Aluminum Clamp, Neoprene Cover and Cork, Membrane Filter C.N. 47mm/0.45um (pk of 100), Vacuum Flask 1000 ml., Vacuum Pump Diaphragm type oil free 25lt/min, Air Vent Filter, Syringe Filter 25mm/0.2um with Needle, Flexible Silicon Tubing 1 mtr., Plastic Tweezers (Forceps)	28000.00
06.730.03	Membrane Filtration Assembly SS Filter Funnel SS 316 with <b>external</b> Clamp rest same as 06.630.01	38000.00
06.730.05	Membrane Filtration Assembly SS Filter Funnel SS 316 with <b>inbuilt</b> SS Clamp rest same as 06.630.01	29500.00
06.630.07	Membrane Filtration Assembly SS (with 500ml Funnel) with inbuilt Clamp, Flask 2000 ml rest same as 06.730.01	33500.00
06.630.09	Three Place Assembly with SS Funnels 250 ml. (External Clamp):- Manifold Three place SS with PTFE valve, Membrane Filter C.N. 47m/0.45um, (pk of 100), Vacuum Flask 2000ml., Vacuum Pump diaphragm Type – oil free, Air Vent Filter – Hydrophobic 50mm/0.2um, Syringe Filter 25mm/0.2um with Needle & Flexible Silicon Tubing 1 mtr.	99500.00
06.630.11	Three Place Assembly with SS Funnels 250 ml (With inbuilt Clamp) rest same as 06.630.09	74400.00
06.630.13	Three Place Assembly with SS Funnels 500 ml (With inbuilt Clamp) rest same as 06.630.09	85800.00
06.630.15	Three Place Assembly with Glass Funnels 250 ml (With inbuilt Clamp) rest same as 06.630.09	75000.00

**06.731 Oil Free Portable Vacuum Pumps (Diaphragm Type)**

Cat. No.	Displacement (ltr / min.)	Max. Vacuum (in Hg)	Motor HP	Price / Piece Rs.
06.731.05	15	22"	1/20	12000.00
06.731.10	25	27"	1/16	16000.00
06.731.15	45	22"	1/8	19500.00
06.731.20	75	27"	1/4	27000.00

**06.732 Oil Free Portable Vacuum Pump (PTFE diaphragm type) Chemical Resistant**

Cat. No.	Displacement (ltr / min.)	Vacuum (in Hg)	Motor HP	Price / Piece Rs.
06.732.15	45	22"	1/8	24800.00
06.732.20	75	27"	1/4	36000.00

**06.734 Hand Vacuum Pump Plastic, with Gauge**

3750.00

**06.735 Tube Sealed, "RELIGLAS", with reduced ends, with Sintered Disc (Pipe line filter) Porosity G-1 or G-2 or G-3 or G-4.**

Cat. No.	Disc Dia mm.	Price / Piece Rs.
06.735.05	30	390.00
06.735.10	40	575.00
06.735.15	50	800.00
06.735.20	65	1400.00
06.735.25	90	2400.00

Note : Please mention Porosity of Sintered Disc, while placing order.

**STOPCOCKS**

**07.741 Stopcock, "RELIGLAS", Straight Bore**

Cat. No.	Description	Price / Piece Rs. Bore 1-2 mm.	Price / Piece Rs. Bore 3-4 mm.
07.741.05	With Solid Plug, side Tube	120.00	198.00
07.741.10	With Solid Plug, Side Capillary	132.00	210.00

**07.745 Stopcock, "RELIGLAS", for Burettes**

Cat. No.	Description	Price / Piece Rs.
07.745.05	With Solid Glass Key	125.00
07.745.10	With PTFE Key	350.00
07.745.15	With PTFE Needle, Screw type	85.00

07.751 Stopcock "RELIGLAS", Screw type PTFE needle, with Two Plain limbs.

Cat. No.	Limbs O.D. mm.	Price/Piece Rs.
07.751.05	8	89.00
07.751.10	10	190.00
07.751.15	12	270.00
07.751.20	15	380.00

07.755 Stopcock, "RELIGLAS", Straight Bore with PTFE key

Cat. No.	Body Wide End I.D. mm Approx.	Key Bore mm.	Price/Piece Rs.
07.755.05	10	1	340.00
07.755.10	12	2	340.00
07.755.15	14	3	385.00
07.755.20	16	4	545.00
07.755.25	19	6	800.00
07.755.30	24	8	1400.00
07.755.35	29	10	2800.00
07.755.40	34	12	4000.00

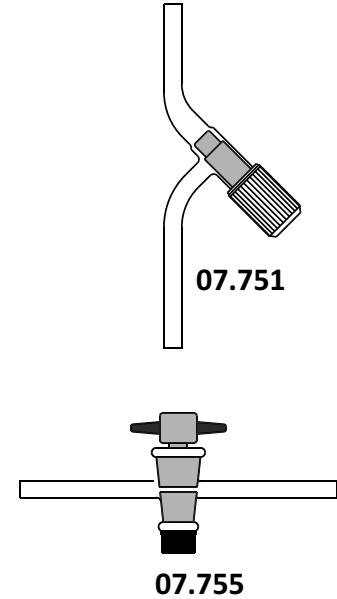

❖ CLINICAL LABORATORY GLASSWARE

08.761 Graduated Micro Capillary Pipettes, Disposable, calibrated "to contain"

Cat. No.	Capacity l.	Graduation l.	Colour Code	Price / 250 Piece Rs.
08.761.01	05	1,2,3,4 & 5	White	870.00
08.761.03	05	5	White	825.00
08.761.05	10	10	Orange	825.00
08.761.07	10	5 & 10	Orange	800.00
08.761.09	20	10 & 20	Black	825.00
08.761.11	20	20	Black	825.00
08.761.13	25	25	White	825.00
08.761.15	44	44.7	Purple	870.00
08.761.17	50	50	Green	825.00
08.761.19	100	100	Blue	825.00
08.761.21	200	200	Red	870.00

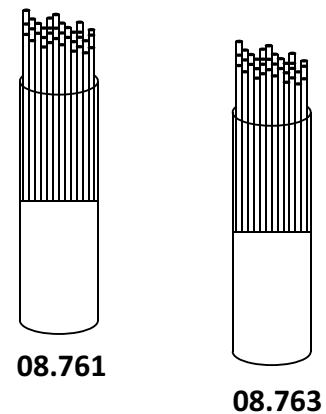

08.763 Capillaries, (Note: Blue for Non Heparinized and Red for Heparinized).

Cat. No.	Description (100/ Vial)	Price/Piece Rs.
08.763.01	75mm non heparinized capillary	100.00
08.763.03	75mm heparinized capillary	148.00
08.763.05	125mm non heparinized blood gas analyzer	450.00
08.763.07	125mm heparinized blood gas analyzer	750.00
08.763.09	90mm B.T.C.T.	85.00
08.763.11	Mice bleeding capillary	300.00
08.763.13	Rat bleeding capillary	300.00
08.763.15	Rabbit bleeding capillary	300.00
08.763.17	32mm strmia non heparinized capillary	85.00
08.763.19	32mm strmia heparinized capillary	150.00

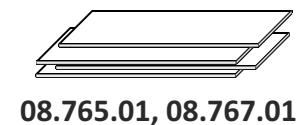

08.765.01, 08.767.01

08.765 Micro Slide : 75 x 25mm Prepared from high quality thin glass, 1.00-1.2mm thick, packed with Paper in between each slide and sealed in transparent P.P. Envelope, Pk. of 50.

Cat. No.	Type	Price/Pk Rs.
08.765.01	Ground Edges	104.00
08.765.03	Ground Edges & one side at one end 19mm frosted Surface	150.00



08.765.03, 08.767.03



08.769

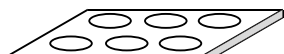

08.771

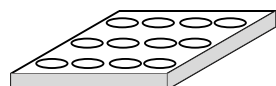

08.773



08.775



08.777.01



08.779

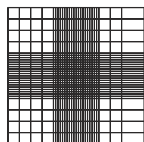

08.777.05

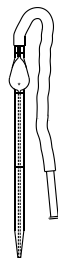

08.777.09/11

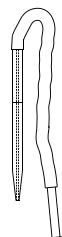

08.779.07



08.779.05

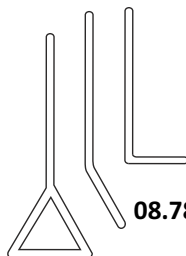

08.780

08.767 Micro Slide : 75 x 25mm Prepared from high quality thin glass, 1.35 mm thick, Pk. of 50.

Cat. No.	Type	Price/Pk Rs.
08.767.01	Ground Edges	72.00
08.767.03	Ground Edges & one side at one end 19mm frosted Surface	105.00

08.769 Micro Concavity Slides: 75x75x1.45mm, spherical concavities are 15-18mm dia 0.5 to 0.6mm deep, beveled and polished edges, Pk. of 10.

Cat. No.	No. of Concavities	Price/Pk Rs.
08.769.01	One	92.00
08.769.03	Two	105.00
08.769.05	Three	125.00

08.771 V.D.R.L. Slides (Kline Concavity Slides) : 75x56x3mm., Concavities 16mm. Dia, 1.75mm. deep, Polished edges, Frosted surface. 12 concavities. **125.00**

08.773 Blood Grouping Slides :100 x 100 x 10mm thick, 12 concavities of 21mm. Dia x 1.5mm. deep, frosted surface (One slide). **370.00**

08.775 Cover Glasses No.1 (Thickness 0.13 to 0.17mm), Pk. of 10 gm, imported glass.

Cat. No.	Type	Size (mm)	Price/Pk. (Rs.)
08.775.01	Square	18 x 18	140.00
08.775.03	Square	22 x 22	140.00
08.775.05	Square	24 x 24	140.00
08.775.07	Rectangular	22 x 40	170.00
08.775.09	Rectangular	22 x 50	170.00
08.775.11	Rectangular	24 x 50	170.00
08.775.15	Haemocytometer	22 x 25 x 0.4mm (10 Pairs)	110.00

08.777 Haemocytometer in box with counting chamber, Cover glasses pair, R.B.C. and W.B.C. Pipettes with rubber suction tubing and mouth piece.

Cat. No.	Description	Price / Piece Rs.
08.777.01	Haemocytometer with Silver line Counting Chamber	2800.00
08.777.03	Haemocytometer with Bright line Counting Chamber	2450.00
08.777.05	Spare Counting chamber, Silver line	2200.00
08.777.07	Spare Counting Chamber, Bright line	1700.00
08.777.09	Spare RBC Pipette	180.00
08.777.11	Spare WBC Pipette	180.00

08.779 Haemometer

Cat. No.	Description	Price / Piece Rs.
08.779.01	Haemometer Complete Set	1100.00
08.779.05	Spare Haemometer Tube	84.00
08.779.07	Spare Haemometer Pipette 20µl	78.00

08.780 Glass Spreader

Cat. No.	Shape	Price / Piece Rs.
08.780.02	L Shape	120.00
08.780.04	Lower Portion at Angle	140.00
08.780.06	Triangular 50 mm	190.00

08.781.02	Staining Rack Assembly, S.S. for 25 slides for Glass Trough	240.00
08.781.04	Staining Trough, Glass, with cover for 08.781.02 rack	500.00
08.781.08	Drying Tray for 24 slides, Aluminum, die pressed	96.00
08.781.10	Carrying Tray for 20 slides, Aluminum, die cut	160.00
08.781.15	Inoculating Loop Holder	62.00
08.781.17	Nichrome Loop, 2mm with holder, Hi-Media Type	75.00
08.781.21	Blood Cell Counter, 9 keys	1850.00
08.781A.05	Coplin Jars Glass for 5-10 slides	200.00
08.781A.07	Coplin Jars Glass for 10-20 slides	500.00
08.781A.09	Coplin Jars Polypropylene for 5-10 slides	69.00
08.781A.11	Staining Jar Glass Big	600.00
08.781A.13	Glass Cavity Block 40x40mm	100.00
08.781A.15	Glass Cavity Block 50x50mm	120.00
08.782.01	Urinometer	150.00
08.782.03	Esbach Albumnometer on stand	250.00
08.782.05	Tissue Embedding S.S. Moulds 16x16x12 mm	300.00
08.782.07	Tissue Embedding S.S. Moulds 22x22x12 mm	300.00
08.782.09	Tissue Embedding S.S. Moulds 32x25x12 mm	300.00
08.782.11	Tissue Capsules S S with Sliding Cover 28x28x9mm	400.00
08.782.13	Tissue Capsules S S with Sliding Cover 20x20x10mm	400.00
08.782.15	ESR Stand for 6 Pipettes	400.00
08.782.17	Wintrobe Tube Stand for 6	300.00
08.782.19	Embedding Ring Disposable	5.00
08.782.21	Embedding Cassettes	8.00
08.782.23	Slide Drying Hot Plate Thermostatically Control	8000.00
08.782.25	Rocking Platform for 24 Vaccutainer Tubes	10500.00
08.782.27	Rocking Platform for 2 Trays.	10500.00
08.782.29	Rotary Mixer for 8 ESR & 8 EDTA Tubes, 15 RPM, 38° Tilting Motion	9000.00
08.782.31	Syringe Needle Destroyer Electrical	18500.00
08.782.33	Syringe Needle Destroyer Manual	800.00

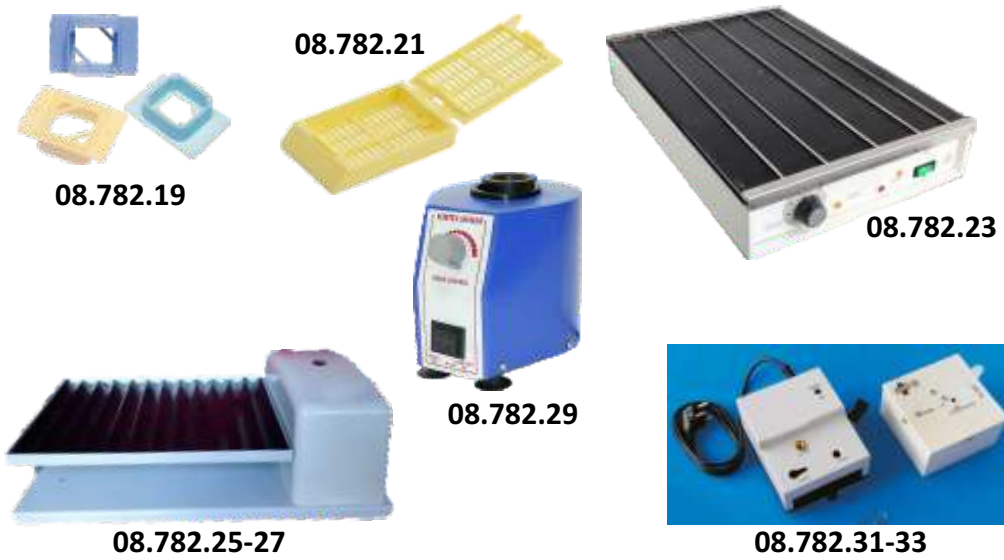

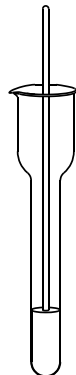

08.785



08.790

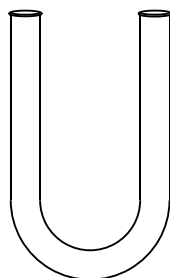

09.799

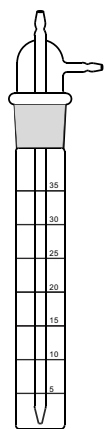

09.795

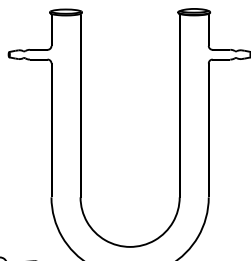

09.801

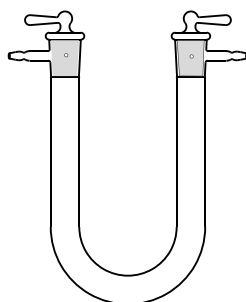

09.803

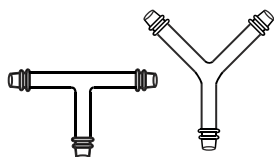

09.804

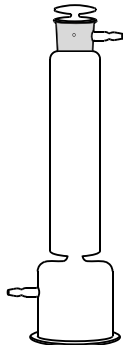

09.805

### TISSUE HOMOGENISERS/ GAS ANALYSIS

08.785 Tissue Homogenisers, PTFE Pestle "RELIGLAS", having stainless steel rod, replaceable vessel of Borosilicate glass to prepare tissue homogenates.

Cat. No.	Capacity ml.	Price/Piece Rs.
08.785.01	5	490.00
08.785.03	10	500.00
08.785.05	30	750.00
08.785.07	50	990.00
08.785.09	100	1250.00

08.790 Conway Type Diffusion Unit, "RELIGLAS", with cover

Cat. No.	Size mm	Inner Chamber O.D. x Ht. (mm)	Price/Piece Rs.
08.790.02	50x17	25x5	420.00
08.790.04	80x17	35x5	440.00
08.790.06	100x17	40x5	625.00

09.794 Gas Desorber for Petroleum Test Lab. **4200.00**

09.795 Impinger, "RELIGLAS", graduated, for gas sampling, as per standard specification, with 24/29 standard joint fitting

Cat. No.	Capacity (ml)	Price/Piece (Rs.)
09.795.01	35	350.00
09.795.03	50	390.00
09.795.05	80	480.00
09.795.07	120	580.00
09.795.09	240	720.00
09.795.11	500	1650.00

09.799 Calcium Chloride Tube, "RELIGLAS", U shape.

Cat. No.	Ht. x Tube O.D. mm. (approx.)	Price/Piece Rs.
09.799.01	100 x 12	60.00
09.799.03	125 x 15	82.00
09.799.05	150 x 18	105.00

09.801 Calcium Chloride Tube, "RELIGLAS", U shape with side tube.

Cat. No.	Ht. x Tube O.D. mm. (approx.)	Price/Piece Rs.
09.801.01	100 x 12	95.00
09.801.03	125 x 15	110.00
09.801.05	150 x 18	130.00

09.803 Calcium Chloride Tube, "RELIGLAS", U shape with side tube and stopper.

Cat. No.	Ht. x Tube O.D. mm. (approx.)	Price/Piece Rs.
09.803.01	100 x 12	325.00
09.803.05	125 x 15	340.00
09.803.07	150 x 18	360.00

09.804 Connection Tube, "RELIGLAS", (Tubing Connectors)

Cat. No.	Ht. x Tube O.D. mm. (approx.)	Shape	Price/Piece Rs.
09.804.01	50 x 8	T	48.00
09.804.03	60 x 10	T	51.00
09.804.05	80 x 12	T	58.00
09.804.07	50 x 8	Y	48.00
09.804.09	60 x 10	Y	51.00
09.804.11	80 x 12	Y	58.00

09.805 Calcium Chloride Tower, "RELIGLAS", Tubular at bottom and stopcock at top.

Cat. No.	Body O.D. x Ht. mm. (approx.)	Price/Piece Rs.
09.805.01	38 x 250	720.00
09.805.03	50 x 300	900.00
09.805.05	60 x 300	1320.00

09.811 Gas Collecting Tubes, "RELIGLAS", with two, two way Glass Key stopcocks one on each side, with side tube, screw cap and rubber septa.

Cat. No.	Capacity ml.	Price/Piece Rs.
09.811.01	125	500.00
09.811.03	250	550.00
09.811.05	500	720.00

09.813 Gas Collecting Tubes, "RELIGLAS", with two, two way PTFE Key stopcocks one on each side, with side tube, screw cap and rubber septa.

Cat. No.	Capacity ml.	Price/Piece Rs.
09.813.01	125	980.00
09.813.03	250	1080.00
09.813.05	500	1250.00

09.815 Gas Washing Bottles, "RELIGLAS", Dreshle's type, interchangeable joints.

Cat. No.	Capacity ml.	Price/Piece Rs.
09.815.01	125	550.00
09.815.03	250	680.00
09.815.05	500	840.00

09.817 Gas Washing Bottles, "RELIGLAS", with sintered disc & interchangeable joint fitting.

Cat. No.	Capacity ml.	Price/Piece Rs.
09.817.01	125	725.00
09.817.03	250	840.00
09.817.05	500	925.00

09.818 Spares for Gas Washing Bottles, "RELIGLAS"

Cat. No.	Description	Price/Pc. Rs.
09.818.01	Spare Bottle only for 09.815 & 09.817, 125 ml	270.00
09.818.03	Spare Bottle only for 09.815 & 09.817, 250 ml	390.00
09.818.05	Spare Bottle only for 09.815 & 09.817, 500 ml	510.00
09.818.11	Spare Head, Plain for 125/ 250/ 500 ml for 09.815	300.00
09.818.13	Spare Head, with Disc for 125/ 250/ 500 ml for 09.817	500.00

Note : Specify the bottle size for order of spare head.

09.825 Gas Jar, "RELIGLAS", with ground Glass flat flange.

Cat. No.	Height mm (approx)	O.D. mm (approx)	Price/Piece Rs.
09.825.01	150	50	420.00
09.825.03	200	50	500.00
09.825.05	200	75	825.00
09.825.07	300	75	945.00

09.831 Gas Generator - Kipp's, "RELIGLAS", with interchangeable joints.

Cat. No.	Capacity ml.	Price/Piece Rs.
09.831.01	250	2400.00
09.831.03	500	3200.00
09.831.05	1000	3800.00

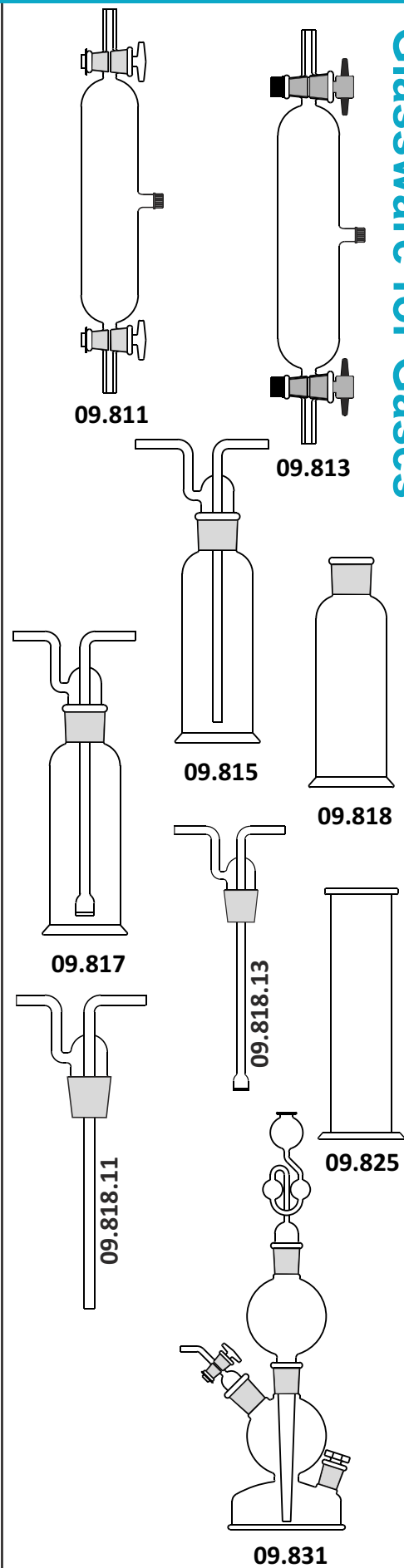



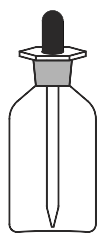

10.835

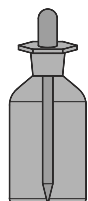

10.836



10.837



10.841

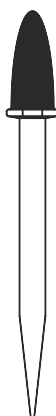

10.842

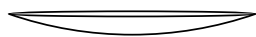

10.845

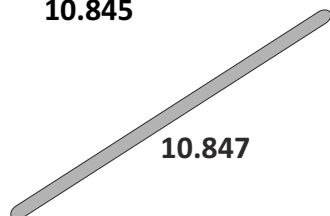

10.847

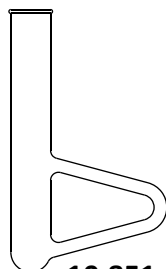

10.851

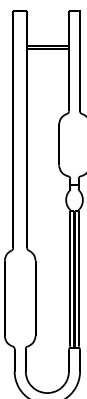

10.853

## MISCELLANEOUS GLASSWARE

- 10.835 Dropping Bottle, Soda glass, polythene stopper with dust proof head, glass dropper and rubber teat.

Cat. No.	Capacity ml.	Price/Piece Rs.
10.835.01	30	95.00
10.835.03	60	112.00
10.835.05	120	126.00

- 10.836 Dropping Bottle, Soda glass, AMBER colour, polythene stopper with dust proof head, glass dropper and rubber teat.

Cat. No.	Capacity ml.	Price/Piece Rs.
10.836.01	30	112.00
10.836.03	60	152.00
10.836.05	120	172.00

- 10.837 Dropping Bottle, T.K. Pattern Soda glass with grooved stopper.

Cat. No.	Capacity ml.	Price/Piece Rs.
10.837.01	30	98.00
10.837.03	60	118.00
10.837.05	120	145.00

- 10.841 Dropper, with capillary jet and rubber teat.

Cat. No.	Description	Price/Piece Rs.
10.841.01	5 cm. with 5 cm. jet	25.00
10.841.03	8 cm. with 10 cm. jet	29.00

- 10.842 Dropper, with rubber teat 15 cm.

25.00

- 10.845 Watch Glass

Cat. No.	Dia mm.	Price/Piece Rs.
10.845.01	50	12.00
10.845.03	62	15.00
10.845.05	75	20.00
10.845.07	100	28.00

- 10.847 Stirring Rod, glass

Cat. No.	Dia. x Length mm.	Price/Piece Rs.
10.847.01	6 x 150	12.00
10.847.03	6 x 200	14.00
10.847.05	8 x 200	18.00
10.847.07	8 x 250	20.00

- 10.851 Thiele's Melting Point Tubes, "RELIGLAS".

Cat. No.	Size mm	Price/Piece Rs.
10.851.01	150 x 18	80.00
10.851.03	150 x 25	90.00

- 10.853 Viscometer, "RELIGLAS", Ostwald, standard size, College Pattern, Centre support.

Cat. No.	Time	Price/Piece Rs.
10.853.01	Standard	170.00
10.853.03	80-100 Sec.	198.00
10.853.05	100-120 Sec.	198.00

**10.855A** Viscometer, "RELIGLAS", U-Tube as per BS/U and ASTM D446 for Transparent Liquids with Calibration Certificate at 20°C.

Cat. No.	Size	Nominal Constant	Viscosity Range	Price/Piece (Rs.)
10.855A.01	0	0.001	-	7800.00
10.855A.03	A	0.003	0.9-3	7800.00
10.855A.05	B	0.01	2-10	7800.00
10.855A.07	C	0.03	6-30	7800.00
10.855A.09	D	0.1	20-100	7800.00
10.855A.11	E	0.3	60-300	7800.00
10.855A.13	F	1	200-1000	7800.00
10.855A.15	G	3	600-3000	7800.00
10.855A.17	H	10	2000-10000	7800.00

**10.855B** Viscometer, "RELIGLAS", Suspended Level as per BS/IP and ASTM D446 with Calibration Certificate at 20°C.

Cat. No.	Size	Nominal Constant	Viscosity Range	Price/Piece (Rs.)
10.855B.01	1	0.01	3.5-10	8000.00
10.855B.03	1A	0.03	6.0-30	8000.00
10.855B.05	2	0.1	20-100	8000.00
10.855B.07	2A	0.3	60-300	8000.00
10.855B.09	3	1	200-1000	8000.00
10.855B.11	3A	3	600-3000	8000.00
10.855B.13	4	10	2000-10000	8000.00
10.855B.15	4A	30	6000-30000	8000.00

**10.855C** Viscometer, "RELIGLAS", U-Tube, Reverse Flow for Opaque liquids as per BS/IP and ASTM D446 with Calibration Certificate at 20°C.

Cat. No.	Size	Nominal Constant	Viscosity Range	Price/Piece (Rs.)
10.855C.01	1	0.003	0.6-3	7800.00
10.855C.03	2	0.01	2-10	7800.00
10.855C.05	3	0.03	6-30	7800.00
10.855C.07	4	0.1	20-100	7800.00
10.855C.09	5	0.3	60-300	7800.00
10.855C.11	6	1	200-1000	7800.00
10.855C.13	7	3	600-3000	7800.00
10.855C.15	8	10	2000-10000	7800.00
10.855C.17	9	30	6000-30000	7800.00

**10.855D** Viscometer, "RELIGLAS", Cannon-Fenske Direct Flow for Transparent Liquid as per BS/IP and ASTM D446 with Calibration Certificate at 20°C.

Cat. No.	Size	Nominal Constant	Viscosity Range	Price/Piece (Rs.)
10.855D.01	25	0.002	0.5-2	7800.00
10.855D.03	50	0.004	0.8-4	7800.00
10.855D.05	75	0.008	1.6-8	7800.00
10.855D.07	100	0.015	3-15	7800.00
10.855D.09	150	0.035	7-35	7800.00
10.855D.11	200	0.1	20-100	7800.00
10.855D.13	300	0.25	50-250	7800.00
10.855D.15	350	0.5	100-500	7800.00
10.855D.17	400	1.2	240-1200	7800.00
10.855D.19	450	2.5	500-2500	7800.00
10.855D.21	500	8	1600-8000	7800.00
10.855D.23	600	20	4000-20000	7800.00

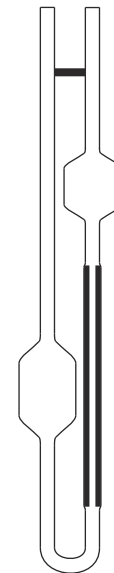

10.855A

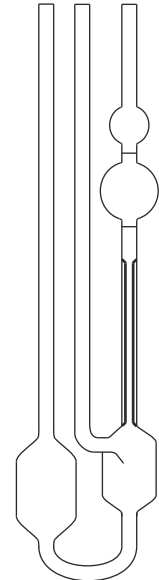

10.855B

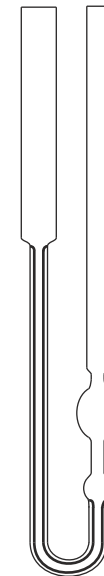

10.855C

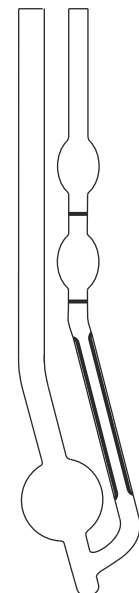

10.855D

Miscellaneous Glassware

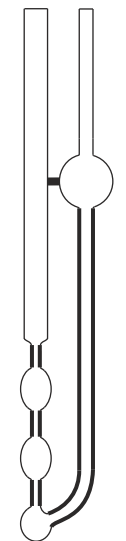

10.855E

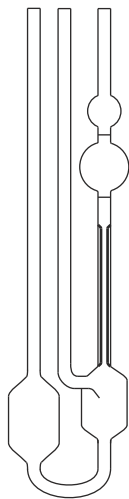

10.855F



10.855G

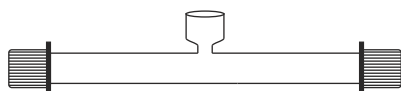

10.855H

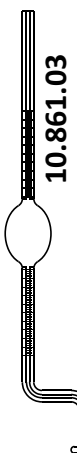

10.861.03

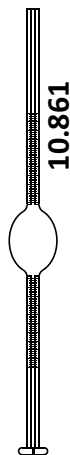

10.861

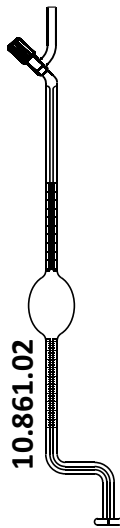

10.861.02

**10.855E** Viscometer, "RELIGLAS", Cannon-Fenske Reverse Flow for Transparent Liquid as per BS/IP and ASTM D446 with Calibration Certificate at 20°C.

Cat. No.	Size	Nominal Constant	Viscosity Range	Price/Piece (Rs.)
10.855E.01	25	0.002	0.4-2	8000.00
10.855E.03	50	0.004	0.8-4	8000.00
10.855E.05	75	0.008	1.6-8	8000.00
10.855E.07	100	0.015	3-15	8000.00
10.855E.09	150	0.035	7-35	8000.00
10.855E.11	200	0.1	20-100	8000.00
10.855E.13	300	0.25	50-200	8000.00
10.855E.15	350	0.5	100-500	8000.00
10.855E.17	400	1.2	240-1200	8000.00
10.855E.19	450	2.5	500-2500	8000.00
10.855E.21	500	8	1600-8000	8000.00
10.855E.23	600	20	4000-20000	8000.00

**10.855F** Viscometer, "RELIGLAS", Ubbelohde for transparent Liquids as per ASTM D446 with Calibration Certificate at 20°C.

Cat. No.	Size	Nominal Constant	Viscosity Range	Price/Piece (Rs.)
10.855F.01	0	0.001	0.3-1	8400.00
10.855F.03	0C	0.003	0.6-3	7600.00
10.855F.05	0B	0.005	1-5	7600.00
10.855F.07	1	0.01	2-10	7600.00
10.855F.09	1C	0.03	6-30	7600.00
10.855F.11	1B	0.05	10-50	7600.00
10.855F.13	2	0.1	20-100	7600.00
10.855F.15	2C	0.2	60-300	7600.00
10.855F.17	2B	0.5	100-500	7600.00
10.855F.19	3	1.0	200-1000	7600.00
10.855F.21	3C	3.0	600-3000	7600.00
10.855F.23	3B	5.0	1000-5000	7600.00
10.855F.25	4	10	2000-10000	7600.00
10.855F.27	4C	30	6000-30000	7600.00

**10.855G** Polarimeter Tubes, , with Center Bulb, screw caps and cover glasses.

Cat. No.	Length mm	Price/Piece Rs.
10.855G.01	100	1200.00
10.855G.03	200	1250.00
10.855G.05	400	1300.00

**10.855H** Polarimeter Tubes, , with Center Cup, screw caps and cover glasses.

Cat. No.	Length mm	Price/Piece Rs.
10.855H.01	100	1250.00
10.855H.03	200	1260.00
10.855H.05	400	1285.00

- 10.861 Stalganometer, "RELIGLAS" Straight, graduated 120.00
- 10.861.02 Stalganometer Straight, Graduated with Screw type PTFE Needle Stopcock 240.00
- 10.861.03 Stalganometer Bend, Graduated 130.00
- 10.861.04 Stalganometer Set of 3 (one straight, 2 bend) 650.00

10.863 Pyknometers, "RELIGLAS"

Cat. No.	Capacity ml.	Price/Piece Rs.
10.863.01	5	78.00
10.863.03	10	84.00
10.863.05	25	108.00

10.865 Filter Tubes, "RELIGLAS", with side tube.

Cat. No.	Tube Size mm.	Price/Piece Rs.
10.865.01	100 x 12	30.00
10.865.03	125 x 15	36.00
10.865.05	150 x 18	39.00
10.865.07	150 x 25	50.00

10.871 Filter Pump, "RELIGLAS"

Cat. No.	Description	Price / Piece Rs.
10.871.01	University pattern	135.00
10.871.03	Edward's type heavy pattern, Brass	1150.00

10.875 Dissolution Bowl, Clear, 1000ml, graduated "RELIGLAS" 2250.00

10.877 Dissolution Bowl, AMBER, 1000ml, graduated "RELIGLAS" 3650.00

10.879 Sampling Tube(Dip Tube) 1 meter long, Dia 19mm, Heavy wall 590.00

10.881 Schoinger Micro Combustion Flask, "RELIGLAS", (Oxygen Flask) with Platinum wire gauge sample carrier, for determination of Halogens, Sulphur, Phosphorous metal, etc. Complies with ASTM E 205-96

10.881.01 Flask Capacity 500ml (Platinum Sample Carrier 2.5 gm) 39500.00

10.881.03 Flask Capacity 1000ml (Platinum Sample Carrier 4 gm) 44000.00

10.882 Practicle Size Determiniation Pipette "RELIGLAS" 2400.00  
(Sedimentation Pipette, Anderson)

10.883 Dirt Correction, "RELIGLAS", 1000 ml. with stopcock

Cat. No.	Description	Price/Piece Rs.
10.883.02	Plain	1800.00
10.883.04	Graduated	2000.00

10.885 Hoffman's Voltmeter, "RELIGLAS", to demonstrate that H<sub>2</sub>O consists of two volumes of Hydrogen and one volume of Oxygen, with two 50 ml. Graduated limbs with stopcocks, central limb with reservoir and removable platinum electrodes.

Cat. No.	Description	Price/Piece Rs.
10.885.01	Complete Set without stand and clamps	1200.00
10.885.03	Platinum Electrodes (Pair)	750.00
10.885.05	Carbon Electrodes (Pair)	140.00
10.885.07	Stand & Clamp for above	1200.00

10.887	Conductivity Cell, "RELIGLAS", Dip type with two rectangular electrodes parallel in a vertical plane, with 0.5 cell constant.	1800.00
10.888	Same as Cat. No. 10.887, but with 1.0 cell constant.	1600.00
10.889	pH Meter combined electrode, glass	1200.00

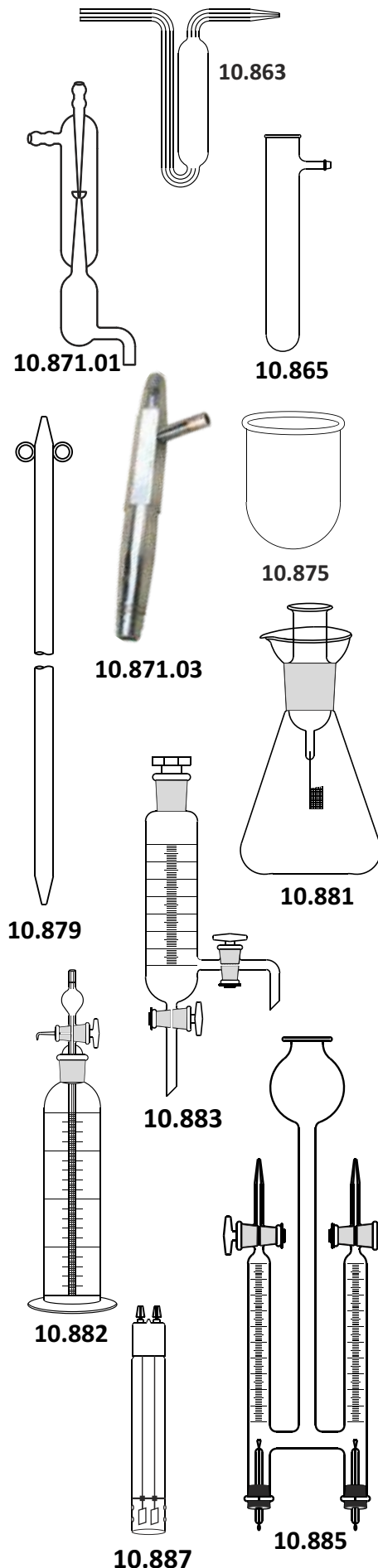

Dairy/ HPLC Vials

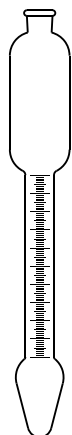

10.891

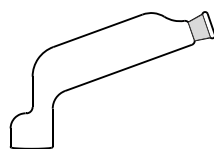

10.909

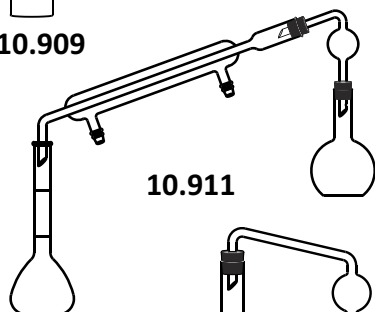

10.911

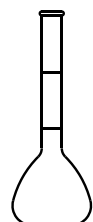

10.931

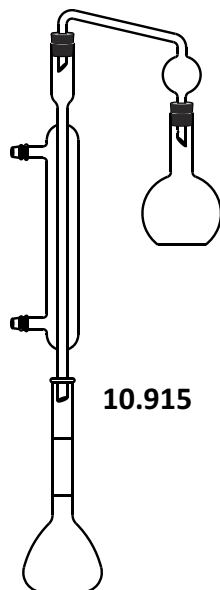

10.915



DAIRY AND MILK TESTING APPARATUS

10.891	Butyrometer with plain neck 10% Dr. Gerber's Design.	160.00
10.893	Butyrometer ISI marked, double tested	195.00
10.895	Butyrometer Butter Grade 0-100% or 0-90% or 0 80% with cup and rubber stopper, weighing type.	1050.00
10.897	Butyrometer Cream 0-70% weighing type as per ISI specifications	1050.00
10.899	Butyrometer Cream 0-70% Volumetric Method, as per ISI specifications.	1050.00
10.901	Butyrometer Skim Milk 0-0.5%.	1050.00
10.905	Lock Stopper for Butyrometer.	12.00
10.907	Lactometer, Sp. Gr. range 1.000 to 1.044.	160.00
10.909	Mojjonier flask as per ISI specifications.	450.00
10.911	Reichert Wollney's Apparatus, "RELIGLAS", for the determination of volatile fatty acids in margarine and butter, with rubber cork fitting.	1200.00
10.913	Reichert Wollney's Apparatus, "RELIGLAS", same as Cat. No. 10.911 but with standard joint fitting.	1500.00
10.915	Polenske's Apparatus, (R.M. Value Apparatus), "RELIGLAS", for the determination of butter fat and analysis of oil, fats, waxes with rubber cork fitting.	1200.00
10.917	Polenske's Apparatus, (R.M. Value Apparatus), "RELIGLAS", Same as Cat. No. 10.915 but with standard joint fitting.	1500.00
10.919	Flask, FB, 300 ml for R.M. value apparatus.	200.00
10.921	Flask, FB, 300ml with 24/29 socket for R.M. value apparatus.	250.00
10.923	Condenser for 10.911 or 10.915, "RELIGLAS"	400.00
10.925	Condenser for 10.911 or 10.915 with 24/29 socket.	500.00
10.927	Still head for Reichert Wollney's Apparatus, "RELIGLAS"	180.00
10.928	Still Head for Reichert Wollney's App. with standard joints.	360.00
10.929	Still Head for R.M. Value Apparatus, "RELIGLAS"	250.00
10.930	Still Head for R.M. Value Apparatus with standard joints.	360.00
10.931	Flask standard marked at 100 & 110 ml. "RELIGLAS"	250.00
10.931N	Flask Standard marked at 100 & 110 ml. "RELIGLAS" with NABL Certificate	550.00

CHROMATOGRAPHY VIALS AND CLOSURES (Pk. of 100)

Cat. No.	Description	Price/Pk. (Rs.)
10.935.01	Vials 2 ml, 12 x 32 mm, Clear Glass, 9 mm screw & PTFE Silicon Septa & Blue Cap	1800.00
10.935.03	Vials 2 ml, 12 x 32 mm, Clear Glass, 9 mm screw & PTFE Silicon Septa & Blue Cap with write on patch	2000.00
10.935.05	Vials 2 ml, 12 x 32 mm, Clear Glass, 9 mm screw & Pre Slit PTFE Silicon Septa & Blue Cap	1850.00
10.935.07	Vials 2 ml, 12 x 32 mm, Clear Glass, 9 mm screw & Pre Slit PTFE Silicon Septa & Blue Cap with write on patch	2050.00
10.935.09	Vials 2 ml, 12 x 32 mm, Clear Glass, 9 mm screw & PTFE Silicon Septa Bonded & Blue Cap	1950.00
10.935.11	Vials 2 ml, 12 x 32 mm, Clear Glass, 9 mm screw & PTFE Silicon Septa Bonded, Blue Cap with write on patch	2150.00
10.935.13	Vials 2 ml, 12 x 32 mm, Clear Glass, 9 mm screw & Pre Slit PTFE Silicon Septa Bonded, Blue Cap	2050.00
10.935.15	Vials 2 ml, 12 x 32 mm, Clear Glass, 9 mm screw & Pre Slit PTFE Silicon Septa Bonded & Blue Cap with write on patch	2250.00
10.935.17	Vials 2 ml, 12 x 32 mm, Amber Glass, 9 mm screw & PTFE Silicon Septa, Blue Cap	1950.00
10.935.19	Vials 2 ml, 12 x 32 mm, Amber Glass, 9 mm screw & PTFE Silicon Septa, Blue Cap with write on patch	2150.00
10.935.21	Vials 2 ml, 12 x 32 mm, Amber Glass, 9 mm screw & Pre Slit PTFE Silicon Septa, Blue Cap	2000.00

10.935.23	Vials 2 ml, 12 x 32 mm, Amber Glass, 9 mm screw & Pre Slit PTFE Silicon Septa, Blue Cap with write on patch	2175.00
10.935.25	Vials 2 ml, 12 x 32 mm, Amber Glass, 9 mm screw & PTFE Silicon Septa Bonded, Blue Cap	2075.00
10.935.27	Vials 2 ml, 12 x 32 mm, Amber Glass, 9 mm screw & PTFE Silicon Septa Bonded, Blue Cap with write on patch	2250.00
10.935.29	Vials 2 ml, 12 x 32 mm, Amber Glass, 9 mm screw & Pre Slit PTFE Silicon Septa Bonded, Blue Cap with write on patch	2150.00
10.935.31	Vials 2 ml, 12 x 32 mm, Amber Glass, 9 mm screw & Pre Slit PTFE Silicon Septa Bonded, Blue Cap with write on patch	2350.00
10.935.33	Vials only 2 ml, 12x32 Clear Glass, 9 mm Screw on Top	780.00
10.935.35	Vials only 2 ml, 12x32 Clear Glass, 9 mm Screw on Top with Write on Patch	980.00
10.935.37	Vials only 2 ml, 12x32 Amber Glass, 9 mm Screw on Top	825.00
10.935.39	Vials only 2 ml, 12x32 Amber Glass, 9 mm Screw on Top with Write on Patch	1100.00
10.935.41	9 mm Blue Screw Cap with PTFE Silicon Septa	1025.00
10.935.43	9 mm Blue Screw Cap with Pre Silt PTFE Silicon Septa	1080.00
10.935.45	9 mm Blue Screw Cap with PTFE Silicon Septa Bonded	1160.00
10.935.47	9 mm Blue Screw Cap with Pre Slit PTFE Silicon Septa Bonded	1250.00
10.935.49	Vial 2 ml, 12x32 mm, 11 mm Snap Top Clear Glass	790.00
10.935.51	Vial 2 ml, 12x32 mm, Snap Top Clear Glass with Write on Patch	1100.00
10.935.53	Vial 2 ml, 12x32 mm, 11 mm Snap Top Amber Glass	920.00
10.935.55	Vial 2 ml, 12x32 mm, 11 mm Snap Top Amber Glass with Write on Patch	1110.00
10.935.57	11 mm Snap Cap with PTFE Silicon Septa	1040.00
10.935.59	11 mm Snap Cap with Pre Slit PTFE Silicon Septa	1110.00
10.935.61	Vial 2 ml, 12x32 mm, 11 mm Crimp Top Clear Glass	790.00
10.935.63	Vial 2 ml, 12x32 mm, Crimp Top Clear Glass with Write on Patch	950.00
10.935.65	Vial 2 ml, 12x32 mm, 11 mm Crimp Top Amber Glass	930.00
10.935.67	Vial 2 ml, 12x32 mm, 11 mm Crimp Top Amber Glass with Write on Patch	1110.00
10.935.69	11 mm Alunimium Crimp Cap with PTFE Silicon Septa	1030.00
10.935.71	11 mm Alunimium Crimp Cap with Pre Slit PTFE Silicon Septa	1080.00

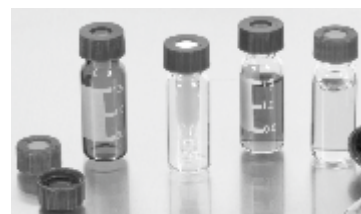

**10.937 Vials, Storage, Screw cap, Made from clear glass tubing with Silicon 1mm Septa & Cap.**

Cat. No.	Capacity (ml)	Size D x L x Neck	Price/ Piece (Rs.)
10.937.01	4	15 x 45 x 13	35.00
10.937.03	6	23 x 40 x 15	45.00
10.937.05	10	23 x 46 x 15	48.00
10.937.07	20	23 x 75 x 15	60.00

**10.937A Vials, storage, Screw cap, made from Amber Glass tubing with silicon 1mm Septa & Cap.**

Cat. No.	Capacity (ml)	Size D x L x Neck	Price/ Piece (Rs.)
10.937A.01	4	15 x 45 x 13	40.00
10.937A.03	6	23 x 40 x 15	50.00
10.937A.05	10	23 x 46 x 15	54.00
10.937A.07	20	23 x 75 x 15	63.00





**10.937B Vials, Working Standard, Made From Amber Glass Tubing With PP Plug, PTFE Septa & Cap.**

Cat. No.	Capacity (ml)	Size D x L (mm)	Price/ Piece (Rs.)
10.937B.01	3	16 x 50	25.00
10.937B.03	5	16 x 55	30.00
10.937B.05	10	25 x 50	42.00
10.937B.07	15	25 x 57	45.00
10.937B.09	20	25 x 72	60.00
10.937B.11	30	25 x 95	78.00

**10.937C Chromatography Vials, Crimp Neck, made from clear glass tubing with Aluminum cap and rubber stopper.**

Cat. No.	Capacity (ml)	Size D x L x Neck	Price/ Piece (Rs.)
10.937C.01	4	16 x 33 x 13	20.00
10.937C.03	6	20 x 41 x 20	24.00
10.937C.05	10	24 x 44 x 20	26.00
10.937C.07	20	24 x 71 x 20	35.00

**10.937D CHROMATOGRAPHY VIALS, Crimp Neck, made from AMBER glass tubing with Aluminum cap and rubber stopper.**

Cat. No.	Capacity (ml)	Size D x L x Neck	Price/ Piece (Rs.)
10.937D.01	4	16 x 33 x 13	24.00
10.937D.03	6	20 x 41 x 20	28.00
10.937D.05	10	24 x 44 x 20	30.00
10.937D.07	20	24 x 71 x 20	45.00

**10.937E Crimping Tools for sealing vial**

Cat. No.	Size mm	Price/Piece Rs.
10.937E.01	13	10015.00
10.937E.03	20	11025.00

**10.937F Decrimping Tools for De Sealing Vial.**

Cat. No.	Size mm	Price/Piece Rs.
10.937F.01	13	10215.00
10.937F.03	20	11425.00



**CHROMATOGRAPHY**

**10.939 Chromatography Columns, "RELIGLAS", with Integral Sintered Disc, without Stopcock.**

Cat. No.	Effective Length mm	Disc Dia mm	Price/ Piece (Rs.)
10.939.01	150	10	245.00
10.939.03	200	15	260.00
10.939.05	300	15	275.00
10.939.07	400	20	320.00
10.939.09	400	30	475.00
10.939.11	500	30	600.00
10.939.13	600	40	790.00
10.939.15	1000	40	835.00



**10.940 Chromatography Columns, "RELIGLAS", without Disc and Stopcock.**

Cat. No.	Effective Length mm	Disc Dia mm	Price/ Piece (Rs.)
10.940.01	200	10	62.00
10.940.03	300	15	88.00
10.940.05	500	20	190.00
10.940.07	600	25	220.00
10.940.09	600	40	480.00
10.940.11	1000	50	1100.00

**10.941 Chromatography Columns, "RELIGLAS", with integral sintered disc & S/C.**

Cat. No.	Effective Length mm	Disc Dia mm	Glass Key S/C (Rs.)	Screw Type S/C (Rs.)	PTFE Key S/C (Rs.)
10.941.01	200	10	395.00	365.00	630.00
10.941.03	300	10	405.00	375.00	635.00
10.941.05	300	18	505.00	465.00	770.00
10.941.07	450	30	665.00	605.00	900.00
10.941.09	500	10	495.00	450.00	700.00
10.941.11	500	18	585.00	525.00	825.00
10.941.13	600	30	690.00	620.00	1025.00
10.941.15	600	40	1100.00	990.00	1250.00
10.941.17	1000	40	1500.00	1350.00	1550.00

**Note :** Please suffix 'G' for Glasskey Stopcock, 'S' for Screw Type Stopcock and 'P' for PTFE Key Stopcock while placing your order.

**10.942 Chromatography Columns, "RELIGLAS", with 24/29 Socket, integral sintered disc & PTFE Key Stopcock.**

Cat. No.	Effective Length mm	Disc Dia mm	Price (Rs.)
10.942.01	200	10	670.00
10.942.03	300	10	680.00
10.942.05	300	18	870.00
10.942.07	450	30	1000.00
10.942.09	500	10	800.00
10.942.11	500	18	925.00
10.942.13	600	30	1200.00
10.942.15	600	40	1400.00
10.942.17	1000	40	1700.00

**10.942A Chromatography Columns, "RELIGLAS", with Reservoir, 24/29 Joint Fitting, integral sintered disc & PTFE Key Stopcock.**

Cat. No.	Effective Length mm	Disc Dia mm	Reservoir Cap. (ml)	Price/ Piece (Rs.)
10.942A.01	200	10	100	960.00
10.942A.03	300	10	100	970.00
10.942A.05	300	18	250	1200.00
10.942A.07	450	30	500	1350.00
10.942A.09	500	10	100	1090.00
10.942A.11	500	18	250	1255.00
10.942A.13	600	30	500	1550.00
10.942A.15	600	40	1000	1750.00
10.942A.17	1000	40	1000	2050.00

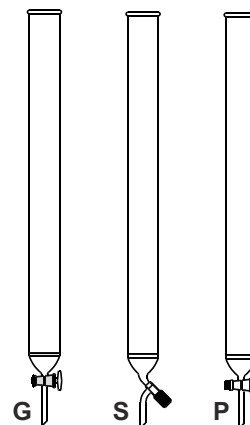

10.941



10.942

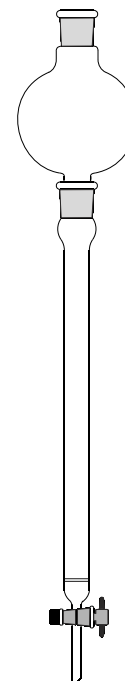

10.942A



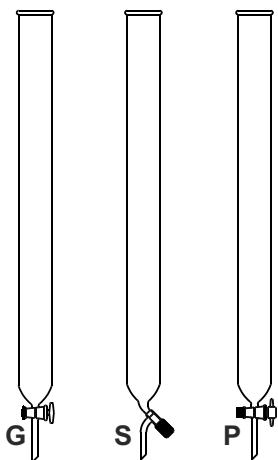

10.945

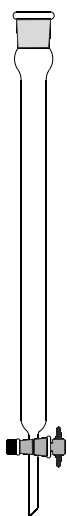

10.946

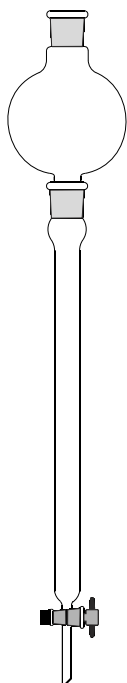

10.946A

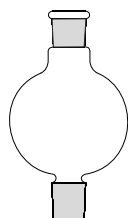

10.947

## 10.945 Chromatography Columns, "RELIGLAS", Plain with stopcock

Cat. No.	Effective Length mm	Dia mm	Glass Key S/C (Rs.)	Screw Type S/C (Rs.)	PTFE Key S/C (Rs.)
10.945.01	200	10	245.00	220.00	500.00
10.945.03	300	10	270.00	240.00	505.00
10.945.05	300	18	300.00	270.00	565.00
10.945.07	450	30	375.00	330.00	715.00
10.945.09	500	10	290.00	260.00	530.00
10.945.11	500	18	300.00	270.00	750.00
10.945.13	600	30	475.00	425.00	865.00
10.945.15	600	40	650.00	585.00	995.00
10.945.17	1000	40	1325.00	1075.00	1650.00

Note: Any other size and type of Chromatography Columns can also be supplied on Request. Please suffix 'G' for Glasskey Stopcock, 'S' for Screw Type Stopcock and 'P' for PTFE Key Stopcock while placing your order.

## 10.946 Chromatography Column, "RELIGLAS", with 24/29 Socket &amp; PTFE Key S/C without Disc.

Cat. No.	Effective Length mm	Outer Dia mm	Price (Rs.)
10.946.01	200	10	570.00
10.946.03	300	10	580.00
10.946.05	300	18	770.00
10.946.07	450	30	900.00
10.946.09	500	10	700.00
10.946.11	500	18	825.00
10.946.13	600	30	1025.00
10.946.15	600	40	1250.00
10.946.17	1000	40	1550.00

## 10.946A Chromatography Columns, "RELIGLAS", with Reservoir, 24/29 Joint Fitting &amp; PTFE Key S/C without Disc.

Cat. No.	Effective Length mm	Outer Dia mm	Reservoir Capacity (ml)	Price/ Piece (Rs.)
10.946A.01	200	10	100	860.00
10.946A.03	300	10	100	870.00
10.946A.05	300	18	250	1100.00
10.946A.07	450	30	500	1250.00
10.946A.09	500	10	100	990.00
10.946A.11	500	18	250	1155.00
10.946A.13	600	30	500	1375.00
10.946A.15	600	40	1000	1600.00
10.946A.17	1000	40	1000	1900.00

## 10.947 Reservoir, Chromatography, "RELIGLAS", with 24/29 Socket &amp; Cone.

Cat. No.	Capacity (ml)	Price / Piece (Rs.)
10.947.01	100	320.00
10.947.03	250	360.00
10.947.05	500	385.00
10.947.07	1000	550.00

**10.949 Gas Tight Micro Liter Syringe, Fixed or Removable**

Cat. No.	Capacity (ul)	Price (Fixed)	Price (Removable)
10.949.01	10	2050.00	2650.00
10.949.03	25	1600.00	1650.00
10.949.05	50	1600.00	1650.00
10.949.07	100	1400.00	1500.00
10.949.09	250	1400.00	1500.00
10.949.11	500	1400.00	1500.00
10.949.13	1000	2000.00	2100.00



10.949

**10.953 Chromatography Sprayers, "RELIGLAS", with rubber bellow.**

Cat. No.	Capacity (ml)	Price / Piece (Rs.)
10.953.01	100	400.00
10.953.03	150	440.00
10.953.05	250	460.00

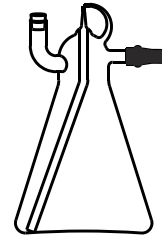

10.953

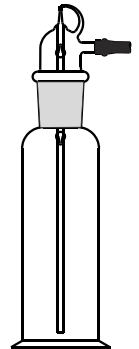

10.955

**10.955 Chromatography Sprayers, "RELIGLAS", with interchangeable joints, rubber bellow.**

Cat. No.	Capacity (ml)	Price / Piece (Rs.)
10.955.01	25	520.00
10.955.03	50	540.00
10.955.05	100	570.00
10.955.07	500	750.00



10.960.02

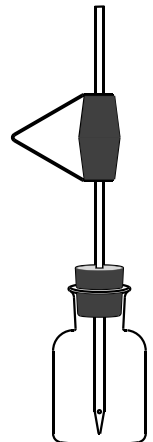

10.960.04

- 10.960.02 **Arsenic Apparatus**, Gutzet modified from according to I.S. Specification 425.00
- 10.960.04 **Arsenic Apparatus, "RELIGLAS"** according to I.P. Specifications 650.00
- 10.960.06 **Arsenic Apparatus, "RELIGLAS"** (Silver Diethylidithio carbonate method) according to I.S. Specifications 1200.00
- 10.960.08 **Arsenic Apparatus, "RELIGLAS"** for the determination of Arsenic and Sb. in brass, bronze, ferrous and non ferrous alloys etc. by distillation, without stand, clamp and burner 2950.00
- 10.960.10 **Arsenic Apparatus, "RELIGLAS"** Gutzeit (modified) comprising of 100 ml. bottle with interchangeable fitting. The arsenic tube is in two parts with ground flange ends, along with 30 ml. open top funnel attached in the bottle. 1800.00
- 10.960.12 **Arsenic Apparatus, "RELIGLAS"** as per USP (US Pharmacopeia) 211, Organic & Inorganic materials 1600.00
- 10.960.14 **Arsenic Limit Test Apparatus, "RELIGLAS"** as per IP 1600.00
- 10.960.16 **Arsenic Limit Test Apparatus, "RELIGLAS"** as per JP 1600.00

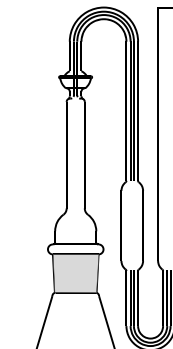

10.960.06

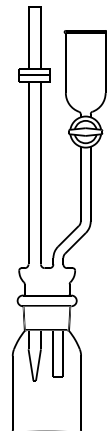

10.960.10

**SILICA LABORATORY WARE**

**11.002 Silica Crucibles, "RELIGLAS", with lid, Translucent, withstands 900°C.**

Cat. No.	Capacity (ml)	Price / Piece (Rs.)
11.002.02	15	790.00
11.002.06	25	910.00
11.002.06	50	1550.00
11.002.08	80	2950.00
11.002.10	100	3450.00
11.002.12	1500	4100.00

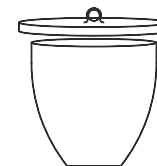

11.002/003

**11.003 Quartz Crucibles, "RELIGLAS", with lid, Transparent, withstands 900°C.**

Cat. No.	Capacity (ml)	Price / Piece (Rs.)
11.003.02	15	1050.00
11.003.06	25	1550.00
11.003.06	50	2400.00
11.003.08	80	3900.00
11.003.10	150	6000.00

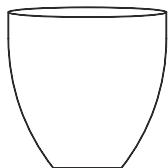

11.004/005



11.006/007

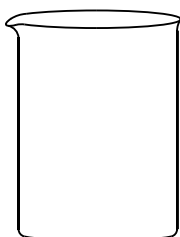

11.008

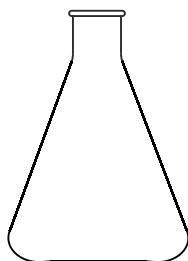

11.010

## 11.004 Silica Crucibles, "RELIGLAS", without lid, translucent, withstands 900°C.

Cat. No.	Capacity ml.	Price/Piece Rs.
11.004.02	15	400.00
11.004.04	25	450.00
11.004.06	50	820.00
11.004.08	80	1400.00
11.004.10	100	1580.00
11.004.12	150	2400.00

## 11.005 Quartz Crucibles, "RELIGLAS", without lid, Transparent, withstands 900°C.

Cat. No.	Capacity ml.	Price/Piece Rs.
11.005.02	15	550.00
11.005.04	25	820.00
11.005.06	50	1250.00
11.005.08	80	2050.00
11.005.10	100	2300.00
11.005.12	150	3000.00

## 11.006 Silica Basins/ Dishes, "RELIGLAS", with spout, Round Bottom, translucent, withstands 800°C.

Cat. No.	Capacity ml.	Dia x Ht. Approx.	Price/Piece Rs.
11.006.02	20	55 x 23	680.00
11.006.04	45	75 x 27	1050.00
11.006.06	70	87 x 33	1400.00
11.006.08	85	94 x 36	1900.00
11.006.10	100	100 x 45	2650.00
11.006.12	200	113 x 47	3100.00

## 11.007 Quartz Basins/ Dishes, "RELIGLAS", with spout, Round Bottom, Transparent, withstands 800°C.

Cat. No.	Capacity ml.	Dia x Ht. Approx.	Price/Piece Rs.
11.007.02	20	55 x 23	980.00
11.007.04	45	75 x 27	2800.00
11.007.06	70	87 x 33	3600.00
11.007.08	85	94 x 36	4600.00
11.007.10	100	100 x 45	4950.00
11.007.12	200	113 x 47	9000.00

## 11.008 Quartz Beakers, "RELIGLAS", low form with spout, Transparent, withstands 900°C.

Cat. No.	Capacity ml.	Price/Piece Rs.
11.008.02	25	1025.00
11.008.04	50	1250.00
11.008.06	100	1650.00
11.008.08	150	2890.00
11.008.10	250	4200.00
11.008.12	500	7600.00
11.008.14	1000	14000.00

## 11.010 Quartz Conical Flasks, "RELIGLAS", Transparent, withstands 900°C.

Cat. No.	Capacity ml.	Price/Piece Rs.
11.010.02	100	5000.00
11.010.04	150	6000.00
11.010.06	250	7500.00
11.010.08	500	12000.00

11.012 Quartz Volumetric Flasks, "RELIGLAS", Transparent, withstands 900°C.

Cat. No.	Capacity ml.	Price/Piece Rs.
11.012.02	10	3900.00
11.012.04	25	4600.00
11.012.06	50	5500.00
11.012.08	100	7500.00
11.012.10	250	12750.00

11.014 Quartz Test Tubes, "RELIGLAS", Transparent, withstands 900°C.

Cat. No.	Size (mm)	Price/Piece (Rs.)
11.014.02	10x75	180.00
11.014.04	12x75	195.00
11.014.06	12x100	250.00
11.014.08	16x125	350.00
11.014.10	16x150	500.00
11.014.12	18x150	825.00
11.014.14	25x100	975.00
11.014.16	25x150	1080.00
11.014.18	25x200	1250.00
11.014.20	32x200	1575.00
11.014.22	40x200	2400.00

11.016 Quartz Combustion Boats, "RELIGLAS", with handle, Transparent, withstands 900°C.

Cat. No.	Size (mm)	Price/Piece (Rs.)
11.016.02	16x49	540.00
11.016.04	12x77	650.00
11.016.06	18x77	800.00
11.016.08	22x77	900.00
11.016.10	22x100	1200.00

11.018 Silica Triangles, "RELIGLAS", for Crucibles

Cat. No.	For Cricle Size	Price/Piece (Rs.)
11.018.02	15 ml	180.00
11.018.04	25 ml	250.00
11.018.06	50 ml	470.00
11.018.08	80 ml	650.00

11.020 Quartz Cell with PTFE Cover, 10 mm path, 3.5 ml. Pair 3000.00

11.021 Glass Cuvette with PTFE Cover, 10 mm path, 3.5 ml. pr. 1050.00

**THERMOMETERS**

12.050 Chemical Thermometers, "RELIGLAS", Mercury Filled 30 cm. long, accuracy ±1 division, made from Imported Capillary.

Cat. No.	Range	Division	Price/Piece Rs.
12.050.02	0-50°C	1/1	220.00
12.050.04	0-50°C	1/2	220.00
12.050.08	-10-110°C	1/1	210.00
12.050.10	-10-110°C	1/2	220.00
12.050.16	0-250°C	1/1	230.00
12.050.20	0-360°C	2/1	300.00

Note : Stirring Thermometers of Cat. No. 12.050 on extra cost of Rs. 5.00 per piece. Rs. 600 extra for NABL Certificate

12.054 Chemical Thermometer, "RELIGLAS" alcohol filled 30cm long made from imported capillary, accuracy ± 1 division.

Cat. No.	Range	Division	Price/Piece Rs.
12.054.02	-10-50°C	1/1	80.00
12.054.04	-10-110°C	1/1	80.00
12.054.06	-10-110°C	1/2	85.00

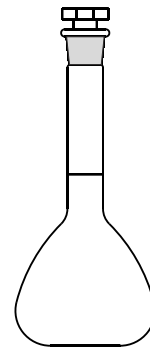

11.012



11.014

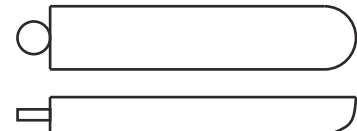

11.016

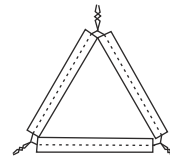

11.018



11.020



12.050



12.054

Thermometers



12.056



12.062



12.070



12.060



12.072



12.074



12.076



12.078



12.084



12.102

12.056 Adjustable PTFE cone 10/19 or 14/23 or 19/26 for holding Thermometers of Cat. No. 12.050, 12.054 & 12.060

Cat No.	Cone Size	Price / Piece Rs.
12.056.02	14/23	410.00
12.056.04	19/26	475.00
12.056.06	24/29	600.00

12.060 Precision Chemical Thermometers, "RELIGLAS" . Accuracy  $\pm 1$  division.

Cat. No.	Range	Division	Price/Piece Rs.
12.060.02	0 – 50°C	1/5	350.00
12.060.04	0 – 50°C	1/10	360.00
12.060.06	0 – 110°C	1/5	350.00
12.060.08	0 – 110°C	1/10	360.00

12.062 Thermometers, "RELIGLAS" with cone, enclosed Type. Accuracy  $\pm 1$  division.

Cat. No.	Range	Cone	Price/Piece Rs.
12.062.02	-10-50°C	10/19	515.00
12.062.03	-10-110°C	10/19	550.00
12.062.16	0-250°C	10/19	550.00
12.062.18	0-360°C	10/19	575.00
12.062.04	-10-110°C	14/23	610.00
12.062.06	0-250°C	14/23	610.00
12.062.08	0-360°C	14/23	640.00
12.062.10	-10-110°C	19/26	900.00
12.062.12	0-250°C	19/26	900.00
12.062.14	0-360°C	19/26	900.00

12.064 Low Temperature Thermometers, "RELIGLAS" (Alcohol Filled). Accuracy  $\pm 1$  division.

Cat. No.	Range	Division	Price/Piece Rs.
12.064.02	-30 to +50°C	1°C	250.00
12.064.04	-50 to +50°C	1°C	275.00
12.064.06	-50 to +100°C	1°C	275.00
12.064.08	-100 to +50°C	1°C	350.00

12.070 Maximum and Minimum Thermometer in plastic case. 300.00

12.072 — do — Superior Quality, Plastic moulded frame similar to Zeal 1200.00

12.074 Wet and Dry Thermometer in plastic case. 300.00

12.076 — do — Superior Quality, Plastic moulded frame similar to Zeal 1200.00

12.078 Wall Thermometer in Plastic Groove type Base Plate, 20 cm. 105.00

12.080 Wall Thermometer in Plastic Groove type Base Plate, 40 cm. 250.00

12.084 Clinical Thermometer 150.00

12.090 Brewer's Thermometer, (Bath Thermometer), Copper case combined scale.

Cat No.	Range	Price / Piece Rs.
12.090.02	0 to 110°C, 240°F	1200.00
12.090.04	0 to 150°C, 300°F	1200.00

12.094 Soil Thermometer in aluminium pipe (stick type) range 10-110°C, with pointed edge, Alcohol filled. 800.00

12.102 Psychrometer, (Whirling Hygrometer) in plastic frame, with chart. 1000.00

❖ PTFE/ PLASTIC LABORATORY WARE

13.200 PTFE Interchangeable Stopper.

Cat. No.	Size	Price / Piece Rs.
13.200.02	10/19	200.00
13.200.04	14/23	300.00
13.200.06	19/26	425.00
13.200.08	24/29	560.00
13.200.10	29/32	675.00
13.200.12	34/35	900.00



13.200

13.202 PTFE Coated Magnetic Needles, Centre Spin

Cat. No.	Length x Dia mm.	Price / Piece Rs.
13.202.02	6 x 3	230.00
13.202.04	10 x 6	132.00
13.202.06	15 x 8	150.00
13.202.08	20 x 8	180.00
13.202.10	25 x 8	200.00
13.202.11	35 x 8	280.00
13.202.12	40 x 8	295.00
13.202.14	50 x 10	390.00
13.202.16	75 x 10	680.00



13.202

13.210 PTFE Beakers with spout .

Cat. No.	Capacity ml.	Price / Piece Rs.
13.210.02	25	620.00
13.210.04	50	1170.00
13.210.06	100	2100.00
13.210.08	250	3940.00
13.210.10	400	4500.00
13.210.12	500	5400.00
13.210.14	1000	8550.00
13.210.16	2000	21600.00



13.210

13.212 PTFE Lid for Beakers

Cat. No.	Suitable for Beaker Capacity (ml.)	Price / Piece Rs.
13.212.02	25	75.00
13.212.04	50	175.00
13.212.06	100	225.00
13.212.08	250	325.00
13.212.10	400	390.00
13.212.12	500	490.00
13.212.14	1000	600.00
13.212.16	2000	945.00



13.212

12.213 PTFE Stirrer

Cat. No.	Type	Size mm	Price/Piece Rs.
12.213.02	Policeman (Retriever)	12 x 300	650.00
12.213.04	Policeman (Retriever)	12 x 400	850.00
12.213.06	Plain with SS Rod	8 x 200	700.00
12.213.08	Plain with SS Rod	10 x 250	900.00
12.213.10	Plain with SS Rod	12 x 300	1200.00
12.213.12	Plain	8 x 200	140.00
12.213.14	Plain	10 x 250	180.00
12.213.16	Plain	12 x 300	325.00
12.213.18	Scraper	10 x 200	1500.00
12.213.20	Scraper	12 x 250	1950.00
12.213.22	Scraper	12 x 300	2200.00



13.213.02

PTFE Labware



13.214



13.216



13.217



13.218



13.219



13.220

## 13.214 Beakers, Polypropylene, Autoclaveable, Graduated.

Cat. No.	Capacity ml.	Price / Piece Rs.
13.214.01	25	18.00
13.214.02	50	18.00
13.214.04	100	20.00
13.214.06	250	40.00
13.214.08	500	58.00
13.214.10	1000	96.00
13.214.12	2000	192.00
13.214.14	5000	550.00

## 13.216 Reagent Bottles (Narrow Mouth), Screwcap, Polypropylene, Autoclaveable.

Cat. No.	Capacity ml.	Price / Piece Rs.
13.216.01	30	19.00
13.216.02	60	24.00
13.216.04	125	32.00
13.216.06	250	54.00
13.216.08	500	66.00
13.216.10	1000	132.00

## 13.217 Reagent Bottles (Narrow Mouth), AMBER, Screwcap, Polypropylene, Autoclaveable

Cat. No.	Capacity ml.	Price / Piece Rs.
13.217.01	30	22.00
13.217.02	60	26.00
13.217.04	125	35.00
13.217.06	250	58.00
13.217.08	500	70.00
13.217.10	1000	148.00

## 13.218 Reagent Bottles (Wide Mouth), Screwcap, Polypropylene, Autoclaveable.

Cat. No.	Capacity ml.	Price / Piece Rs.
13.218.01	30	22.00
13.218.02	60	26.00
13.218.04	125	36.00
13.218.06	250	62.00
13.218.08	500	80.00
13.218.10	1000	140.00

## 13.219 Reagent Bottles (Wide Mouth), AMBER, Screwcap, Polypropylene, Autoclaveable.

Cat. No.	Capacity ml.	Price / Piece Rs.
13.219.01	30	24.00
13.219.02	60	29.00
13.219.04	125	40.00
13.219.06	250	68.00
13.219.08	500	88.00
13.219.10	1000	170.00

## 13.220 Carboy, Polypropylene, Autoclaveable.

Cat. No.	Capacity ltr.	Price / Piece Rs.
13.220.02	10	2200.00
13.220.04	20	3300.00

**13.222 Aspirator Bottles, Polypropylene, Autoclaveable with Leakproof spigot screwed to the bottle body.**

Cat. No.	Capacity ltr.	Price / Piece Rs.
13.222.01	2	1200.00
13.222.02	5	1500.00
13.222.04	10	2800.00
13.222.06	20	4000.00



13.222

**13.223 Dropping Bottle, PP**

Cat. No.	Capacity ml.	Price / Piece Rs.
13.223.05	60	32.00
13.223.10	120	40.00

**13.224 Wash Bottles, Polythylene**

Cat. No.	Capacity ml.	Price / Piece Rs.
13.224.02	125	48.00
13.224.04	250	60.00
13.224.06	500	80.00
13.224.08	1000	140.00



13.224

**13.225 Wash Bottles, Polythylene**

Cat. No.	Capacity ml.	Price / Piece Rs.
13.225.02	125	72.00
13.225.04	250	100.00
13.225.06	500	126.00



13.225

**13.226 Flasks Stand Polypropylene, Autoclaveable. 200.00**



13.226

**13.228 Connector (T & Y) Polypropylene, Autoclaveable.**

Cat. No.	Description	Price / Piece Rs.
13.228.02	T Connector-6mm	18.00
13.228.04	Y Connector-6mm	18.00
13.228.06	T Connector-8mm	22.00
13.228.08	Y Connector-8mm	22.00
13.228.10	T Connector-10mm	30.00
13.228.12	Y Connector-10mm	30.00



13.228

**13.230 Dessicator (Vaccum) Polypropylene/Polycarbonate, Autoclaveable, with Perforated plate.**

Cat. No.	Dia. mm	Price / Piece Rs.
13.230.02	150	2500.00
13.230.04	200	3900.00
13.230.06	250	4900.00
13.230.08	300	7800.00



13.230

**13.232 Dessicator (Plain) Polypropylene/Polycarbonate, Autoclaveable, with Perforated plate.**

Cat. No.	Dia. (mm)	Price / Piece (Rs.)
13.232.02	150	1480.00
13.232.04	200	2700.00
13.232.06	250	3600.00
13.232.08	300	6000.00



13.232

**13.234 Buchner Funnel, Polypropylene, Autoclaveable**

Cat. No.	Dia. (mm)	Price / Piece (Rs.)
13.234.02	70	154.00
13.234.04	90	200.00
13.234.06	110	225.00







13.236



13.236



13.238



13.240



13.241.66



13.241.84

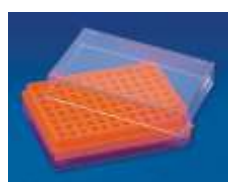

13.241.86

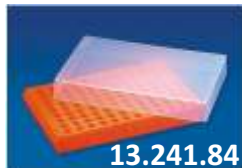

13.241.84

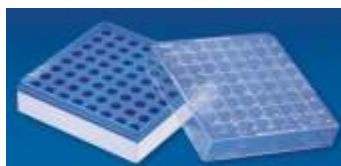

13.241.88



13.241.82



13.241.72

13.236 Analytical Funnel, Polypropylene, Autoclaveable.

Cat. No.	Dia. (mm)	Price / Piece (Rs.)
13.236.03	35	9.00
13.236.04	50	10.00
13.236.06	62	18.00
13.236.08	75	19.00
13.236.10	100	38.00

13.237 Powder Funnel, Polypropylene, Autoclaveable.

Cat. No.	Dia. (mm)	Price / Piece (Rs.)
13.237.04	55	14.00
13.237.06	65	21.00
13.237.08	80	24.00
13.237.10	100	48.00
13.237.12	150	50.00
13.237.14	200	280.00
13.237.16	250	640.00

13.238 Petri Dish (Disposable), Polystyrene, 90mm dia. (100/Pack) 1300.00

13.240 Test Tube Stand (3 Tier), Polypropylene, Autoclaveable.

Cat. No.	Description	Price / Piece (Rs.)
13.240.02	13mm x 31 Tubes	202.00
13.240.04	16mm x 31 Tubes	202.00
13.240.06	20mm x 20 Tubes	285.00
13.240.08	25mm x 12 Tubes	202.00
13.240.10	25mm x 18 Tubes	285.00
13.240.12	32mm x 12 Tubes	340.00
13.240.14	25mm x 36 Tubes	575.00
13.240.16	13mm x 18 Tubes	128.00
13.240.18	15mm x 18 Tubes	128.00
13.240.20	18mm x 12 Tubes	128.00
13.240.22	13mm x 62 Tubes	405.00
13.240.24	16mm x 62 Tubes	405.00
13.240.26	20mm x 40 Tubes	575.00
13.240.28	13mm x 48 Tubes	300.00
13.240.30	13mm x 72 Tubes	342.00

13.241 Racks & Stands, Polypropylene, Autoclaveable.

Cat. No.	Description	Price / Piece (Rs.)
13.241.52	2 x 25mm & 4 x 16mm holes and 6 Pegs	54.00
13.241.54	6 x 25mm Holes	84.00
13.241.56	Round, 4 x 25mm, 8 x 19mm, 12 pegs	235.00
13.241.66	Nessler Cylinder, 6 x 50ml	300.00
13.241.68	Nessler Cylinder, 6 x 100ml	300.00
13.241.72	Universal Multi Rack, PP	640.00
13.241.75	Rotatable Multi Rack, PP	1090.00
13.241.78	Rack for Micro Centrifuge, 24 tubes	400.00
13.241.80	Rack for Micro Centrifuge, 48 tubes	800.00
13.241.82	Float Rack for 16 Nos. MCT	160.00
13.241.84	MCT Twin Rack for 0.5ml & 1.5ml MCT	570.00
13.241.86	PCR Tube rack for 96 of 0.2ml	400.00
13.241.88	MCT Box for 100 MCT of 0.5ml	500.00
13.241.90	MCT Box for 64 MCT of 1.5ml	500.00

**13.242 Pipette Stand, Polypropylene, Autoclaveable.**

Cat. No.	Description	Price / Piece (Rs.)
13.242.02	Horizontal For 12 Pipettes	220.00
13.242.04	Vertical For 28 Pipettes	725.00

**13.244 Pipette Box, Polypropylene, Autoclaveable.**

310.00

**13.246 Retort Stand, PS/PP, Rod 12.5 x 750mm**

Cat. No.	Description	Price / Piece Rs.
13.246.01	Base 225x150mm, Side Hole	745.00
13.246.03	Base 300x200mm, Centre Hole	1275.00
13.246.05	Base 300x200mm, Side Hole	1275.00

**13.250 Measuring Cylinder, Raised Graduations, Polypropylene, Autoclaveable.**

Cat. No.	Capacity ml.	Price / Piece Rs.
13.250.02	10	23.50
13.250.04	25	38.00
13.250.06	50	50.00
13.250.08	100	54.00
13.250.10	250	144.00
13.250.12	500	234.00
13.250.14	1000	342.00
13.250.16	2000	945.00

**13.254 Measuring Jugs, Raised Graduations, Polypropylene, Autoclaveable.**

Cat. No.	Capacity (ml)	Price / Piece (Rs.)
13.254.02	250	44.00
13.254.04	500	57.00
13.254.06	1000	104.00
13.254.08	2000	182.00
13.254.10	3000	300.00
13.254.12	5000	500.00

**13.256 Stirrer, Polypropylene, Autoclaveable.**

Cat. No.	Description	Price / Piece (Rs.)
13.256.02	10mm x 250 mm	24.00
13.256.04	6mm x 150 mm	10.00
13.256.06	7mm x 200 mm	17.00
13.256.08	7mm x 250 mm	20.00
13.256.10	7mm x 300 mm	24.00

**13.258 Policemen Stirring Rod, P.P., Autoclaveable, 6mm x 245 mm 24.00**

**13.260 Trays, Polypropylene, Autoclaveable.**

Cat. No.	Description	Price / Piece Rs.
13.260.02	Laboratory Tray 450x350x75mm	500.00
13.260.04	Laboratory Tray 375x300x75mm	350.00
13.260.06	Utility Tray 375x350x130mm	665.00
13.260.07	Laboratory Tray 540 x 435 x 130mm	880.00
13.260.08	Carrier Tray 380x240x115mm	775.00
13.260.10	Instrument Tray 220x150x70mm	400.00
13.260.12	Instrument Tray 450x150x70mm	700.00

**13.261.07 Burette Clamp, Single, PP 92.00**

**13.261.09 Burette Clamp, Double, PP 180.00**

**13.261.11 Separating Funnel Holder, PP 120.00**

**13.261.13 Funnel Holder, Single, PP 99.00**

**13.261.15 Funnel Holder, Double, PP 195.00**

**13.264 Draining Rack, Acrylopitrile Butadiene Styrene/Polycarbonate 3700.00**

**13.264.02 Draining Rack, ABS Polycarbonate, 56 pegs 8300.00**



13.242.04



13.242.02



13.244



13.250



13.246.03



13.256



13.254



13.260



13.261.09



13.261.11

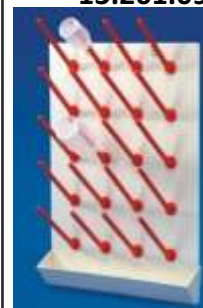

13.264



13.261.13



13.270



13.290



13.274



14.272



14.274

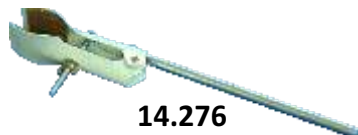

14.276



14.276.04



14.278

## 13.270 Slide Mailer/ Box, Polypropylene, Autoclaveable.

Cat. No.	Description	Price / Piece Rs.
13.270.02	1 Slide	12.00
13.270.04	2 Slides	20.00
13.270.06	5 Slides	20.00
13.270.08	10 Slides	30.00
13.270.10	25 Slides	96.00
13.270.12	50 Slides	192.00
13.270.14	100 Slides	300.00

13.272	Pasteur Pipette, 3ml, Disposable (Pack of 500)	900.00
13.274	Urine Container, 30ml (Pack of 100)	750.00
13.276	Urine Container, 50ml (Pack of 100)	1200.00
13.278	Micro Centrifuge, 1.5ml (Pack of 500)	600.00
13.280	Disposable Gloves (No. 6.5 or 7 or 7.5), Pack of 100	1800.00
13.282	Disposable Face Mask (Pack of 100)	400.00
13.284	Disposable Face Mask, N95 (each)	120.00
13.288	Cryo Vials, 2ml (Pack of 100)	500.00
13.290	Centrifuge Tube, Graduated, PP, 15ml (Pack of 100)	1000.00
13.292	Centrifuge Tube, Graduated, PP, 50ml (Pack of 50)	900.00
13.294	Spirit Swabs (Pack of 100)	220.00
13.296	Serological Pipette, Disposable, 1ml (Pack of 100)	2800.00
13.298	Serological Pipette, Disposable, 2ml (Pack of 100)	2800.00
13.300	Serological Pipette, Disposable, 5ml (Pack of 100)	3500.00
13.302	Serological Pipette, Disposable, 10ml (Pack of 100)	5200.00

## ❖ LABORATORY CLAMPS AND STANDS

## 14.272 Laboratory Jack

Cat. No.	Plate Size	Mild Steel Rs./ each	SS Rs./ each
14.272.05	12 x 14 cm	2100.00	4500.00
14.272.10	15 x 15 cm	2275.00	5280.00
14.272.15	20 x 20 cm	2640.00	7325.00
14.272.20	25 x 25 cm	3900.00	9800.00
14.272.25	30 x 30 cm	5500.00	12250.00

NOTE: Suffix 'M' for Mild Steel and 'S' for Stainless Steel

14.274 Burette Clamps, Made of thick Mild Steel Sheet. All die-pressed symmetrical, non breakable, one holds the burette rests and other presses it due to spring force. Boss head can accommodate upto 18 mm. dia rod.

Cat. No.	Description	Price / Piece (Rs.)
14.274.05	Single For One Burette	125.00
14.274.10	Double For Two Burettes	220.00
14.274.15	Aluminium for One Burette, Fisher Type	235.00
14.274.20	Aluminium for Two Burettes, Fisher Type	325.00

14.276 Universal Clamps, Sheet metal, Die Pressed, cork lined jaws, can hold up to 12 to 50 mm dia.

Cat. No.	Description	Price / Piece (Rs.)
14.276.02	M.S. Epoxy Coated	150.00
14.276.04	Clamp with swivel type rotatable boss head	390.00

14.278 Universal Clamps (Condenser Clamp), Made of casted alloy, Cork lined jaws, can hold 75 mm dia articles, with chrome plated 8 mm. dia 175 mm long mild steel rod for holding in the boss head.

Cat. No.	Description	Price / Piece (Rs.)
14.278.02	Aluminium, Epoxy coated	250.00
14.278.04	Brass, Chrome Plated.	575.00
14.278.06	Zinc die Casted, with Boss Head	450.00

**14.280 Finger Clamps (Condenser)**, Made of casted alloy, prongs cross over one another, with chrome plated 8 mm. dia, 175 mm long mild steel rod for holding in the boss head.

Cat. No.	Description	Price Piece (Rs.)
14.280.02	3 Finger clamps-hold up to 75 mm. dia., Aluminium epoxy coated.	240.00
14.280.03	3 Finger Clamp with swivel type rotatable boss head	400.00
14.280.04	Same as 14.280.02 but made of Brass, Chrome Plated	525.00
14.280.06	4 Finger Clamps-hold up to 75 mm. dia., Aluminium epoxy coated.	240.00
14.280.08	Same as 14.280.06 but Brass, Chrome Plated	525.00
14.280.10	4 Finger Clamp-hold up to 75 mm dia., Zinc casted	400.00

**14.282 Condenser Clamps, "JUMBO"**.

Cat. No.	Description	Price / Piece Rs.
14.282.02	Brass casted, Chrome Plated. 4 Fingers covered with Silicon Sleeves, Jaws do not cross over, can hold upto 125 mm. dia. with 300 x 10 mm, CP rod	1750.00
14.282.04	— do — Aluminium casted, epoxy coated	750.00

**14.284 Condenser Clamp**, 3 Fingers covered with Silicon Sleeves, two keys independently operated, Chrome Plated Mild Steel Rod 300 x 10 mm.

Cat. No.	Description	Price / Piece Rs.
14.284.02	Aluminium alloy, epoxy coated	600.00
14.284.04	Brass casted, Chrome Plated	1300.00
14.284.06	Zinc Casted	800.00
14.284.08	Zinc Casted with Zinc Boss Head	1050.00

**14.286 Condenser Clamp, Co-axial**, 3 fingers covered with Silicon sleeves, can hold from 18 mm to 75 mm dia, with 300 x 10 mm. C.P. rod.

Cat. No.	Description	Price / Piece Rs.
14.286.02	Brass, Chrome Plated	1050.00
14.286.04	Aluminium, Epoxy Coated	590.00
14.286.06	Steel Sheet, Chrome Plated	500.00

**14.288 Retort Clamps**, Cork lined cylindrical jaws, can hold up to 50 mm., with 175 x 8 mm Chrome plate M.S. Rod.

Cat. No.	Description	Price / Piece Rs.
14.288.02	Aluminium casted, epoxy coated	250.00
14.288.04	Brass casted, Chrome Plated	510.00

**14.289 Thermometer Clamp** with die casted Boss Head 365.00

**14.292 Boss Head, Cast iron, Black painted, with C.P. Screws.**

Cat. No.	Description	Price / Piece Rs.
14.292.02	To hold upto 12 mm. dia rod	110.00
14.292.04	— do — 16 mm. dia. Rod.	175.00
14.292.06	— do — 25 mm. dia. Rod.	220.00

**14.296 Boss Head**, Die-pressed, Chrome Plated, or epoxy coated made of thick mild steel strip, can accommodate up to 16mm dia rod. 75.00

**14.298 Boss Head, with chrome plated screws, to hold upto 16 mm. dia rod.**

Cat. No.	Description	Price / Piece Rs.
14.298.02	Aluminium casted , epoxy coated	82.00
14.298.03	Brass casted, Chrome Plated to hold 13mm rod	350.00
14.298.04	Brass casted, Chrome plated to hold 18mm rod	495.00
14.298.06	Zinc Alloy casted	150.00



14.280.02



14.280.03

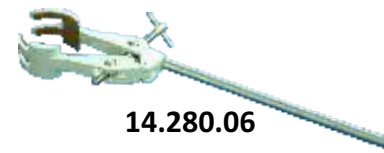

14.280.06



14.282



14.284



14.286



14.288



14.292



14.296



14.298



14.300

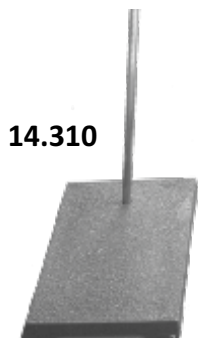

14.310



14.311

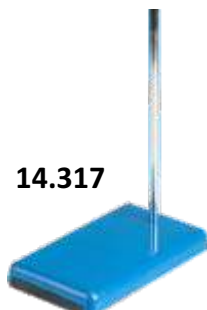

14.317



14.320



14.324

**14.300 Boss Head, Universal, Aluminium casted, to hold upto 13mm rod, Multi Purpose, Revolving** 220.00

**14.310 Stand, Rectangular, Cast Iron, Painted Base with mild steel Chrome Plated or powder coated rod.**

Cat. No.	Base Size (Approx in cm)	Rod (in cm)	Price/Piece Rs.
14.310.02	15 x 10	45 x 1	460.00
14.310.04	17 x 12	60 x 1	540.00
14.310.06	20 x 12	60 x 1	575.00
14.310.08	20 x 12	60 x 1.2	620.00
14.310.09	20 x 12 St. Steel	60 x 1.2	1320.00
14.310.10	22 x 15	75 x 1.2	960.00
14.310.11	22 x 15 St. Steel	60 x 1.2	1600.00
14.310.12	25 x 15	75 x 1.2	1100.00
14.310.14	25 x 20	75 x 1.2	1400.00
14.310.16	30 x 17	75 x 1.2	1700.00

**14.311 Stand, Rectangular, Mild Steel Epoxy coated Base with mild steel Chrome Plated or powder coated rod.**

Cat. No.	Base Size (Approx in cm)	Rod (in cm)	Price/Piece Rs.
14.311.02	15 x 10	45 x 1	300.00
14.311.04	17 x 12	60 x 1	360.00
14.311.06	20 x 12	60 x 1	390.00
14.311.08	20 x 12	60 x 1.2	440.00
14.311.10	22 x 15	75 x 1.2	670.00
14.311.12	25 x 15	75 x 1.2	770.00
14.311.16	30 x 17	75 x 1.2	975.00

**14.317 Stand, Retort, Die pressed Mild Steel thick sheet Epoxy coated Base with mild steel Chrome Plated or powder coated rod.**

Cat. No.	Base Size (Approx in cm)	Rod (in cm)	Price/Piece Rs.
14.317.02	15 x 10	50 x 1.2	500.00
14.317.04	20 x 12	60 x 1.2	660.00
14.317.06	25 x 15	75 x 1.2	1150.00

**14.320 Tripod Stand, Black painted top, three balanced plated screwed legs.**

Cat. No.	Top	Height	Price/Piece Rs.
14.320.02	Triangular, 10cm	15cm	135.00
14.320.04	Triangular, 10cm	20cm	150.00
14.320.06	Triangular, 12cm	20cm	190.00
14.320.08	Round, dia, 12 cm	15cm	200.00
14.320.10	Round, dia, 12cm	20cm	220.00

**14.324 Retort Ring, with fixed boss head to take upto 12 mm. dia. rod.**

Cat. No.	Description	Price / Piece Rs.
14.324.02	MS Ring, Dia. of Ring 5 cm	124.00
14.324.03	MS Ring, Dia. of Ring 6.2 cm	125.00
14.324.04	MS Ring, Dia. of Ring 7.5 cm	130.00
14.324.06	MS Ring, Dia. of Ring 10 cm	148.00
14.324.08	MS Ring, Dia. of Ring 12 cm	160.00
14.324.10	MS Ring, Dia. of Ring 15 cm	190.00
14.324.22	SS Ring, Dia. of Ring 5 cm	280.00
14.324.24	SS Ring, Dia. of Ring 6.2 cm	280.00
14.324.26	SS Ring, Dia. of Ring 7.5 cm	280.00
14.324.28	SS Ring, Dia. of Ring 10 cm	340.00
14.324.30	SS Ring, Dia. of Ring 12 cm	375.00

14.328 Crucible Tongs

Cat. No.	Length in cm	Material	Price/Piece Rs.
14.328.02	15	Mild Steel, C.P.	74.00
14.328.04	15	Stainless Steel	100.00
14.328.06	20	Mild Steel, C.P.	89.00
14.328.08	20	Stainless Steel	124.00
14.328.10	30	Mild Steel, C.P.	220.00
14.328.12	30	Stainless Steel	300.0
14.328.14	45	Stainless Steel	475.00
14.328.16	60	Stainless Steel	1100.00

- 14.330 **Flask Tongs**, 30 cm. long, Stainless Steel 340.00
- 14.332 **Beaker Tongs**, 30 cm. long, Stainless Steel 340.00
- 14.332A **Beaker Tongs**, 30 cm. long, Stainless Steel wrapped with heat resistant yarn 410.00
- 14.333 **Bunsen Burner**, die pressed Zinc Base with C.P Brass pipe and pilot flame 800.00
- 14.334 **Burner Bunsen**, made of thick brass pipe 12 mm dia., chrome plated, screw type air regulator. Painted heavy base, 150 mm. height Approx. 300.00
- 14.334A **Burner Bunsen**, Nickel plated burner tube 115 x 13mm, with rotatable air regulator, mounted on a powder coated, heavy die cast base of 80mm dia, overall height approx 140mm 650.00
- 14.335 **Burner Bunsen**, made of thick brass pipe 12 mm dia., chrome plated, screw type air regulator. Painted heavy base, 150 mm. height Approx. With Stopcock 400.00
- 14.335A **Burner Bunsen**, Heavy cast iron powder coated base with stopcock, Double Walled Brass Pipe with spare jet. 830.00
- 14.335B **Burner Bunsen with Flame Spreader** made of Brass chrome plated Needle Valve type, Heavy sheet metal base and brass chrome plated pipe. 760.00
- 14.335H **Bunsen Burner, High Pressure**, Heavy cast iron powder coated base brass tube, dia 18mm. With spare jet. with Stop Cock for high pressure. 740.00
- 14.335.03 **Burner Bunsen**, with Needle Valve, C.P 12 mm dia Brass Pipe, screwed air regulator, epoxy coated C.I. Base 530.00
- 14.336 **Mecker Burner**, made of chrome plated brass tube, painted cast iron base, height 180 mm. approx. top dia 25 mm. with mesh. 1070.00
- 14.337 **Mecker Burner**, made of chrome plated brass tube, painted cast iron base, height 180 mm. approx. top dia 25 mm. with mesh. With Stopcock. 1150.00
- 14.338 **Teclu Burner**, made of chrome plated brass tube with regulating cone, give a powerful flame and higher temp. painted cast iron base, height 160mm approx. 1240.00
- 14.338E **Electric Bunsen Burner** 12000.00
- 14.339 **Wire Gauge**, with ceramic center, 15 x 15cm 48.00

14.340 Cork Borers, All brass, chrome plated.

Cat. No.	Set of	Price / Piece (Rs.)
14.340.02	3, Heavy Pattern	775.00
14.340.04	3, Regular quality	225.00
14.340.06	6, Heavy Pattern	1580.00
14.340.08	6, Regular quality	390.00
14.340.10	12, Heavy Pattern	4000.00
14.340.12	12, Regular quality	2000.00



14.328



14.330



14.332



14.334A



14.335



14.335A



14.335B



14.335H



14.335.03



14.337



14.338



14.339



14.340



14.344



14.348



14.352



14.353



14.354



14.356



14.359

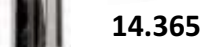

14.365

14.360



14.367

## 14.344 Hoffman's Screw Clip, Brass chrome plated.

Cat. No.	Size (mm)	Price / Piece (Rs.)
14.344.02	12	144.00
14.344.04	18	165.00
14.344.06	25	170.00

## 14.348 Test Tube Holder, chrome plated.

36.00

## 14.352 Spatula, Stainless Steel

Cat. No.	Size	Price / Piece (Rs.)
14.352.02	One end flat, One end spoon, 10 cm	27.00
14.352.04	One end flat, One end spoon, 15 cm	30.00
14.352.06	One end flat, One end spoon, 20 cm	40.00
14.352.08	One end flat, One end spoon, 25 cm	89.00
14.352.10	One end flat, One end spoon, 30 cm	120.00
14.352.22	Micro, wire pattern, 10 cm, one end spoon	28.00
14.352.24	Micro, wire pattern, 15 cm, one end spoon	35.00
14.352.26	Micro, wire pattern, 20 cm, one end spoon	50.00
14.352.28	Micro, wire pattern, 25 cm, one end spoon	60.00
14.352.30	Micro, wire pattern, 30 cm, one end spoon	88.00
14.352.32	Micro, One end Flat & other pointed, 15cm	35.00
14.352.34	Micro, One end Flat & other pointed, 20cm	45.00
14.352.36	Micro, One end Flat & other pointed, 25cm	60.00
14.352.38	Micro, One end Flat & other pointed, 30cm	110.00
14.352.42	Chattaway, One end Flat & other bent up, 10cm	30.00
14.352.44	Chattaway, One end Flat & other bent up, 15cm	36.00
14.352.46	Chattaway, One end Flat & other bent up, 20cm	50.00
14.352.48	Chattaway, One end Flat & other bent up, 25cm	65.00
14.352.50	Chattaway, One end Flat & other bent up, 30cm	95.00

## 14.353 Spatula, Stainless Steel, Ointment, Flexible Blade, Wooden Handle.

Cat. No.	Size	Price / Piece Rs.
14.353.02	10 cm	120.00
14.353.04	15 cm	135.00
14.353.06	20 cm	160.00

## 14.354 Swan Neck Tap, Brass, chrome plated.

Cat. No.	Type	Price / Piece Rs.
14.354.02	One way	2150.00
14.354.04	Two way	3400.00
14.354.06	Three way	4350.00

## 14.356 Gas tap, Brass moulded, copper oxidised / Chrome Plated.

Cat. No.	Type	Price / Piece Rs.
14.356.02	One way	600.00
14.356.04	Two way	850.00
14.356.06	Three way	1150.00
14.356.08	Four way	1270.00

## 14.359 Sprite Lamp, Stainless Steel, 120ml

100.00

## 14.360.03 Pipette Box, Stainless Steel, 75 x 450mm (DxH), Jointless

1100.00

## 14.365 Petri Dish Box, Stainless Steel, Jointless for 10 pcs

2300.00

## 14.367.02 Forceps, Stainless Steel, 125 mm

75.00

## 14.367.04 Forceps, Stainless Steel, 150 mm

98.00

## 14.367.06 Forceps, Stainless Steel, 200 mm

120.00

## 14.367.08 Forceps, Stainless Steel, 300 mm

200.00

14.370 Test Tube Stand, Aluminium, Anodized

Cat. No.	Size	Price / Piece Rs.
14.370.02	12mm x 12 Holes	125.00
14.370.03	16mm x 12 Holes	135.00
14.370.04	18mm x 12 Holes	185.00
14.370.06	25mm x 12 Holes	245.00
14.370.08	12mm x 24 Holes	155.00
14.370.09	16mm x 24 Holes	165.00
14.370.10	18mm x 24 Holes	230.00
14.370.12	25mm x 24Holes	345.00
14.370.14	12mm x 36 Holes	185.00
14.370.15	16mm x 36 Holes	215.00
14.370.16	18mm x 36 Holes	300.00
14.370.18	25mm x 36Holes	600.00
14.370.24	Nessler Cylinder, 50ml, 6 hole	550.00
14.370.26	Nessler Cylinder, 100ml, 6 hole	750.00

14.375 Test Tube Stand, Stainless Steel

Cat. No.	Size	Price / Piece Rs.
14.375.02	12mm x 12 Holes	200.00
14.375.03	16mm x 12 Holes	240.00
14.375.04	18mm x 12 Holes	285.00
14.375.06	25mm x 12 Holes	350.00
14.375.08	12mm x 24 Holes	275.00
14.375.09	16mm x 24 Holes	325.00
14.375.10	18mm x 24 Holes	375.00
14.375.12	25mm x 24Holes	525.00
14.375.14	12mm x 36 Holes	320.00
14.375.15	16mm x 36 Holes	375.00
14.375.16	18mm x 36 Holes	525.00

Cat. No.	Description	Price/Piece Rs.
14.380.03	Draining Rack for Glassware, SS, 32 pegs, 70 x 55 cm	6300.00
14.380.05	Draining Rack for Glassware, MS, 32 pegs, 70 x 55 cm	3200.00
14.381.01	Agate Mortar & Pestle, Black, Size: 50 mm	920.00
14.381.03	Agate Mortar & Pestle, Black, Size: 75 mm	1395.00
14.381.05	Agate Mortar & Pestle, Black, Size: 100 mm	2600.00
14.381.07	Agate Mortar & Pestle, Black, Size: 125 mm	4000.00
14.381.09	Agate Mortar & Pestle, Black, Size: 150 mm	7800.00
14.385.01	Buchner Funnel, Porcelain, Dia 35mm for 27mm filter paper	115.00
14.385.03	Buchner Funnel, Porcelain, Dia 50mm for 47mm filter paper	125.00
14.385.05	Buchner Funnel, Porcelain, Dia 60mm for 50mm filter paper	132.00
14.385.07	Buchner Funnel, Porcelain, Dia 75mm for 70mm filter paper	198.00
14.385.09	Buchner Funnel, Porcelain, Dia 100mm for 90mm filter paper	285.00
14.385.11	Buchner Funnel, Porcelain, Dia 125mm for 110mm filter paper	400.00
14.385.13	Buchner Funnel, Porcelain, Dia 150mm for 130mm filter paper	685.00
14.385.15	Buchner Funnel, Porcelain, Dia 200mm for 170mm filter paper	1900.00
14.385.17	Buchner Funnel, Porcelain, Dia 250mm for 230mm filter paper	3000.00
14.385.19	Buchner Funnel, Porcelain, Dia 300mm for 280mm filter paper	5875.00
14.391.03	Scoop, Stainless Steel, Capacity 250 gm	800.00
14.391.05	Scoop, Stainless Steel, Capacity 500 gm	1100.00
14.391.07	Scoop, Stainless Steel, Capacity 750 gm	1500.00
14.391.09	Scoop, Stainless Steel, Capacity 1000 gm	2000.00
14.391.11	Scoop, Stainless Steel, Capacity 1500 gm	2500.00



14.370



14.375



14.380.05



14.381



14.385



14.391





15.400



15.404



15.412

### ❖ LABORATORY RUBBER GOODS

#### 15.400 Laboratory Rubber Tubing, Extra Soft quality.

Cat. No.	Approx. Bore mm.	Wall Thickness $\pm 0.5$ mm.	Price/10 mtr. Rs.
15.400.02	4	1.0	300.00
15.400.04	5	1.5	400.00
15.400.06	6	1.5	505.00
15.400.08	7	1.5	580.00
15.400.10	8	1.5	660.00
15.400.12	9	2.0	800.00
15.400.14	10	2.0	960.00
15.400.16	12	2.5	1100.00
15.400.18	16	3.0	1690.00
15.400.20	19	3.0	2020.00

#### 15.404 High Pressure Rubber Tubing, Superior quality.

Cat. No.	Approx. Bore mm.	Wall Thickness $\pm 0.5$ mm.	Price/ 10 Mtr. Rs.
15.404.02	3.0	4.5	900.00
15.404.04	4.5	4.5	1060.00
15.404.06	6.0	4.5	1235.00
15.404.08	8.0	4.5	1520.00
15.404.10	9.0	4.5	1680.00
15.404.12	12.5	6.5	2725.00

#### 15.408 Ordinary Pressure Rubber Tubing, Superior quality.

Cat. No.	Approx. Bore mm.	Wall Thickness $\pm 0.5$ mm.	Price/10 Mtr. Rs.
15.408.02	3.0	3	570.00
15.408.04	4.5	3	680.00
15.408.06	6.0	3	840.00
15.408.08	8.0	3	1000.00
15.408.10	9.0	3	1120.00
15.408.11	10.0	4	1600.00
15.408.12	12.5	4.5	2400.00

#### 15.412 Silicon Rubber Tubing

Cat. No.	OD mm.	ID mm.	Wall Thickness mm	Price/Mtr Rs.
15.412.02	4	2	1	80.00
15.412.04	5	3	1	86.00
15.412.06	6	4	1	148.00
15.412.08	7	5	1	168.00
15.412.10	7	4	1.5	168.00
15.412.12	8	6	1	235.00
15.412.14	8	5	1.5	235.00
15.412.16	8	4	2	290.00
15.412.18	9	6	1.5	280.00
15.412.20	10	7	1.5	330.00
15.412.22	10	6	2	330.00
15.412.24	11	8	1.5	395.00
15.412.26	11	7	2	395.00
15.412.28	12	8	2	405.00
15.412.30	12	6	3	690.00
15.412.32	14	10	2	570.00
15.412.34	14	8	3	600.00
15.412.36	16	12	2	620.00
15.412.38	16	10	3	840.00
15.412.40	19	12	3.5	1050.00
15.412.42	23	15	4	1620.00
15.412.44	25	16	4.5	2050.00

15.416 Silicon Rubber Stoppers

Cat. No.	Bottom Dia mm.	Top Dia mm.	Height mm	Price/Each Rs.
15.416.02	9	11.5	20	22.00
15.416.04	11	14	24	35.00
15.416.06	13	16	24	45.00
15.416.08	15	18	24	57.00
15.416.10	17	20	26	70.00
15.416.12	18	21	26	72.00
15.416.14	19	22.5	28	85.00
15.416.16	23	25.5	28	124.00
15.416.18	25	28.5	28	150.00
15.416.20	27	31	32	170.00
15.416.22	29	33	32	220.00
15.416.24	31	36	35	280.00
15.416.26	33	38.5	38.5	360.00



15.416

15.420 Suba Seal Stoppers, Rubber/ Silicon, autoclavable with turn over flange and serrations for Test tube.

Cat. No.	For Test Tube OD mm.	Price / Piece (Rs.) Rubber	Price / Piece (Rs.) Silicon
15.420.02	12	28.00	46.00
15.420.04	15	34.00	62.00
15.420.06	18	46.00	85.00
15.420.08	25	56.00	108.00



15.420

Note: Please Suffix R for Rubber and S for Silicon

15.424 Suba Seal Stoppers, Rubber/ Silicon, autoclavable with turn over flange, Plain.

Cat. No.	For Test Tube OD mm.	Price / Piece (Rs.) Rubber	Price / Piece (Rs.) Silicon
15.424.02	12	28.00	46.00
15.424.04	15	34.00	62.00
15.424.06	18	46.00	85.00
15.424.08	25	56.00	105.00



15.424

Note: Please Suffix 'R' for Rubber and 'S' for Silicon

15.425 Suba Seal Stoppers, Rubber/ Silicon, autoclavable with turn over flange, Plain.

Cat. No.	For Socket Size	Price / Piece (Rs.) Rubber	Price / Piece (Rs.) Silicon
15.425.02	14/19	47.00	85.00
15.425.04	19/26	60.00	126.00
15.425.06	24/29	70.00	148.00
15.425.08	29/32	94.00	220.00

Note: Please Suffix 'R' for Rubber and 'S' for Silicon

15.428 Cone for Filtration Flasks Rubber/ Silicon.

Cat. No.	Suitable for Filter Flask ml	Price / Piece (Rs.) Rubber	Price/ Piece (Rs.) Silicon
15.428.02	250	110.00	425.00
15.428.04	500	110.00	425.00
15.428.06	1000	180.00	770.00
15.428.08	2000	180.00	770.00
15.428.10	5000	230.00	960.00
15.428.12	10000	450.00	1310.00

Note: Please Suffix 'R' for Rubber and 'S' for Silicon



15.428



15.432



15.436

15.440



15.444



15.450



15.452



15.454



15.456



15.458



15.460



15.465

## 15.432 Rubber Cork extra soft quality.

Cat. No.	Top Dia. mm.	Bottom Dia mm.	Height mm	No.	Price/ 10 Pcs. Rs.
15.432.02	13	9	15.5	0	33.00
15.432.04	14	11	18.5	1	41.00
15.432.06	16.5	13	20	2	49.00
15.432.08	19	14	21	3	60.00
15.432.10	21	15	22	4	67.00
15.432.12	22.5	17.5	23	5	75.00
15.432.14	24.5	20	24	6	105.00
15.432.16	26	20	27.5	7	120.00
15.432.18	26.5	21	27.5	8	136.00
15.432.20	28	21.5	31	9	173.00
15.432.22	30	26	33	10	210.00
15.432.24	33	29	32	11	240.00
15.432.26	34.5	30	34.5	12	270.00
15.432.28	38.5	31	37	13	370.00
15.432.30	41.5	32	42.5	14	410.00
15.432.32	42	38	40.5	15	550.00
15.432.34	45	35.5	36.5	16	560.00
15.432.36	49.5	40	40.5	17	660.00
15.432.38	53.5	48	33.5	18	780.00
15.432.40	58	44	45	19	920.00
15.432.42	60	51	56.5	20	1300.00

Note: For one hole 1.00 & Two hole 1.50 extra charge.

15.436	Police Man, Silicon Rubber 5 mm Hole for Insert	105.00	
15.438	Spatula Silicon Rubber 5 mm Hole for Insert	120.00	
		Rubber	Silicon
15.440.02	Pipette Bulb Small for 5ml	27.00	57.00
15.440.04	Pipette Bulb Medium for 10ml	30.00	77.00
15.440.06	Pipette Bulb Large for 15ml	37.00	93.00
15.440.08	Pipette Bulb Extra Large for 20ml	40.00	110.00
15.440.10	Pipette Bulb Oval Shape for 25ml	67.00	200.00
15.440.12	Pipette Bulb XX Large for 50ml	110.00	400.00
15.440.14	Pipette Bulb XXX Large for 100ml	200.00	520.00
15.444	Chloroform Bellow with cotton net for Automatic Burette		390.00
15.448	Automizer Bulb for chromatography sprayer		135.00
15.450	Rubber Teat for dropper		7.00
15.452	Propiptor (Pipette Filler) with 3 valves		150.00
15.452.01	Propiptor Silicon Rubber with 3 valves		475.00
15.454	Hand Grip, Silicon for holding hot articles		1200.00
15.456	Flask Stand, Silicon, Universal		2600.00
15.456.01	Stand Silicon for 25ml Round Bottom Flask	60.00	180.00
15.456.03	Stand Silicon for 50ml Round Bottom Flask	80.00	210.00
15.456.05	Stand Silicon for 100ml Round Bottom Flask	120.00	288.00
15.456.07	Stand Silicon for 250ml Round Bottom Flask	170.00	432.00
15.456.09	Stand Silicon for 500ml Round Bottom Flask	350.00	804.00
15.456.11	Stand Silicon for 1000ml Round Bottom Flask	780.00	1680.00
15.456.13	Stand Silicon for 2000ml Round Bottom Flask	1280.00	3600.00
15.458	Filter Cones, Set of 7		400.00
15.458.01	Filter Cones, Set of 7, Guko Silicon		1200.00
15.460.01	Gas Sampling Bladder, Latex, No. 4		230.00
15.460.03	Gas Sampling Bladder, Latex, No. 5		250.00
15.460.05	Gas Sampling Bladder, Latex, No. 6		320.00
15.460.07	Gas Sampling Bladder, Double Nozzel		280.00
15.465.03	Lab Sheet/Mat Rubber Size 24 x 24 cm, Thickness 2.5 mm		220.00
15.465.05	Lab Sheet/Mat Rubber Size 30 x 30 cm, Thickness 5 mm		3100.00
15.465.07	Lab Sheet/Mat Silicon Size 24 x 24 cm, Thickness 2.5 mm		2050.00
15.465.09	Lab Sheet/Mat Silicon Size 30 x 30 cm, Thickness 5 mm		4950.00

**ANAEROBIC CULTURE JAR**

- 16.460 **Anaerobic Culture Jar (Mcintosh and Fildes Pattern), "RELIGLAS",** for the safe growth of anaerobes through COLD CATALYST. It consists of a glass Jar approx. 23 cm. high x 13 cm. dia., metal cover fitted with two needle valves for evacuating and filling and a sachet for holding the Catalyst, but without catalyst. The jar can be used both with Gas cylinder as well as with Gas packs. Complete with petri dish holder. **11500.00**
- 16.464 — do — with pressure gauge. **12000.00**
- 16.468 **Anaerobic Culture Jar** made of **Stainless Steel** with SS lid and with side tube for Indicator. Complete with cold catalyst. Other details are as per Cat. No. 16.460. With combined Pressure & vacuum gauge. **15400.00**
- 16.476 **Anaerobic Culture Jar (Anaerobic System without Catalyst)** Transparent, unbreakable poly carbonate jar of 3.5 litre capacity having sturdy Aluminum / ABS molded Lid, clamp and sealing ring. Supplied complete with SS Test Tube carrier, SS Petri plate Carrier, 5 Sachets of gas packs. No need of catallyst and gases. **17500.00**
- 16.480 **Anaerobic Culture Jar (Anaerobic System without Catalyst)** 19000.00  
Transparent, unbreakable poly carbonate jar of 3.5 litre capacity, having sturdy Aluminum Lid, clamp and sealing ring with built in Safety features, fitted with Vacuum cum Pressure Gauge, pressure valve and Safety Valve. Supplied with. SS Test Tube carrier, SS Petri plate Carrier for 10, 5 sachets of Gas Packs

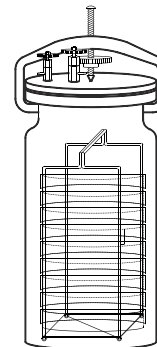

16.460



16.468



16.476

**CHROMATOGRAPHY**

- 16.500 **Thin Layer Chromatography Kit 'RELITECH',** Comprising of moveable applicator (Spreader) with built in arrangement, 0-2 mm, perspex base plate 114 x 23 cm., Aluminum Carrier, perspex spotting temp plate, developing chamber with lid, five T.L.C. plates 20 x 20 cm., two T.L.C. plates 20 x 5 cm., scribe for marking lines, micropipette and glass sprayer with rubber bellow.

Cat. No.	Description	Price/Piece Rs.
16.500.02	With Chrome plated Brass Applicator	14500.00
16.500.04	With Aluminium Applicator	13250.00

**Spares & Accessories :**

16.500.06	Applicator Brass	6900.00
16.500.08	Applicator Aluminium	4150.00
16.500.10	Spotting Temp plate, perspex	750.00
16.500.12	Aluminium Carrier for ten plates of 20 cm x 20 cm	1575.00
16.500.14	Plate rack of S.S. for two plates, 20x20 cm.	750.00
16.500.16	T.L.C. Glass Plates 20x20 cm.	100.00
16.500.18	— do — 20x10 cm.	65.00
16.500.20	— do — 20x 5 cm.	54.00
16.500.22	Chromatography Tank (Developing Chamber) with cover for T.L.C. Plates of size 20 x 20 cm.	2850.00
16.500.24	— do — 20 x 10 cm.	2200.00
16.500.26	— do — 20 x 5 cm.	1750.00
16.500.28	Perspex Base plate size approx. 114 x 23 cm.	2400.00
16.500.30	Dessicator Cabinet 30x50x35cm.	10500.00

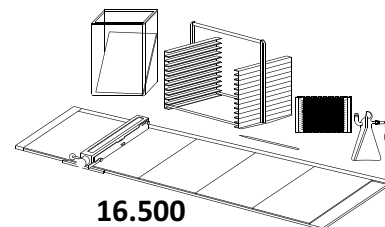

16.500

- 16.510 **Paper Chromatography Cabinet 'RELITECH'** Ascending or Descending, made of teak wood and glass construction. It can accomodate two (troughs) and six glass rods.

Cat. No.	Description	Price/Piece Rs.
16.510.02	Cabinet size: 60 x 30 x 60 cm approx for 4 filter papers of 46 x 57 cm Size	18500.00
16.510.04	Cabinet size: 80 x 37.5 x 65 cm approx for 6 filter papers of 75 x 75 cm Size	24000.00



16.510



16.512 – 16.514

- 16.512 Ultra Violet Chromatography Inspection Cabinet, 'RELITECH'** for viewing and detecting separated substances on T.L.C. Layers, fitted with long wave (365 nm.) U.V. Lamp for use on 220 volts A.C.

Cat. No.	Description	Price/Piece (Rs.)
16.512.02	Fitted with One UV Lamp	8800.00
16.512.04	Fitted with Two UV Lamps	9750.00

- 16.514 Ultra Violet Fluorescence Inspection Cabinet, 'RELITECH'**, 18500.00  
Dual wave, having filter fitted with separate low pressure mercury vapour tubes for short ultra violet (254 nm) and long UV (365 nm) plus separate lamp for visible light. The low pressure mercury vapour tubes facilitate immediate use.

<b>16.514.02</b>	<b>Ultra Violet Tube, 254nm for above cabinets</b>	1100.00
<b>16.514.04</b>	<b>Ultra Violet Tube, 365nm for above cabinets</b>	1100.00



## ROTARY VACUUM EVAPORATOR

- 16.530 'RELITECH' Rotary Vacuum Flash Evaporator.**

Comprising of non sparking geared drive unit, support stand fitted with Jack arrangement on Stainless Steel rod, continuously variable speed regulator, water bath, glass condenser, pear shaped evaporating flask Capacity 800 ml., 1000 ml. receiving flask with ball joints, feeding tube and vapor path tube, with PTFE / Rubber seals for maintaining complete vacuum.

Cat. No.	Description	Price/Piece Rs.
16.530.01	Diagonal Condenser with Thermostatic Water Bath	65000.00
16.530.03	Diagonal Condenser with Digital Water Bath	75000.00
16.530.05	Diagonal Condenser with Digital Water Bath, Digital RPM Display, Speed Control & Motorized Lift.	120000.00
16.530.07	Vertical Condenser with Thermostatic Water Bath	68000.00
16.530.09	Vertical Condenser with Digital Water Bath	78000.00
16.530.11	Vertical Condenser with Digital Water Bath, Digital RPM Display, Speed Control & Motorized Lift.	123000.00
16.530.13	Cold Trap Condenser with Thermostatic Water Bath	70000.00
16.530.15	Cold Trap Condenser with Digital Water Bath	78000.00
16.530.17	Cold Trap Condenser with Digital Water Bath, Digital RPM Display, Speed Control & Motorized Lift.	125000.00
16.530.19	Oil Free Portable Vacuum Pump (45 ltr/Min.) for above	27000.00
16.530.21	Chiller (Refrigerated Water Circulator) Cap. 10 ltr SS Tank, with Digital Temp. Controller	110000.00

### Spares :

16.531.01	Diagonal Double Coil Condenser with S-35 Ball Joint	8200.00
16.531.03	Vertical Double Coil Condenser with S-35 Ball Joint	8900.00
16.531.05	Cold Trap Condenser with S-35 Ball Joint	8500.00
16.531.07	Receiving Flask 1000 ml. with S-35 cup joint	1050.00
16.531.09	Boiling Flask 800 ml. with 24/29 Joint	840.00
16.531.11	Feed tube for Rotary Evaporator condenser	800.00
16.531.13	Vapour path tube for Rotary Evaporator	1000.00
16.531.15	Silicon washer for condenser of Rotary Evaporator	300.00
16.531.17	Oil seal silicon rubber for Rotary Evaporator	200.00
16.531.19	Tension spring for condenser of Rotary Evaporator	98.00
16.531.21	Clip to hold boiling flask & vapour path tube	60.00

**Note:** Refer Cat. No. 02.367 for other capacities of Boiling Flasks and Cat. No. 03.496 to 03.499 for Vapour Traps.

Installation charges for 16.530 :

From distance 0-500 Km	6000.00
From distance 500-1000 Km	10000.00
From distance 1000-2000 Km	15000.00



16.530.05



## KJELDHAL APPARATUS

**16.540 Universal Combined Kjeldhal Digestion and Distillation Unit 'RELITECH'.** Electrically heated, comprising of one single mild steel tubular stand provided with two shelves one above the other. A specially designed glass fume duct with 24/29. Cone openings (suitable for flasks having 24/29 socket) having such provision so that no leakage of fumes takes place. One heater box having individual energy regulators for 500 watts heaters are supplied in digestion part at the lower side. One heater box of above design is supplied in distillation part at the upper side. Distillation part is also provided with brass condenser rack with water circulation systems and clamps. The whole unit is operated on 220 volts AC mains.

Cat. No.	Description	Price / Piece Rs.
16.540.02	Complete unit with glass parts for 6 tests	55000.00
16.540.04	-do- without glass parts for 6 tests	36000.00
16.540.06	Complete unit with glass parts for 3 tests	31500.00
16.540.08	-do- without glass parts for 3 tests	25500.00



16.540

**16.550 Kjeldhal Digestion Unit, 'RELITECH',** Complete with heating box and fume duct. The 500 watts heaters are 6 inches apart having individual on/off switches and energy regulators. The height of the side clamps provided, is adjustable to accommodate Kjeldhal flasks of 300 ml., 500 ml. or 800 ml. The unit is supplied with Fume Duct. Kindly place order for Kjeldhal flasks extra as per requirement.

Cat. No.	Description	Price / Piece Rs.
16.550.02	Unit for 3 Tests with 3x500ml flasks.	15000.00
16.550.04	Unit for 3 Tests w/o flasks.	10750.00
16.550.06	Unit for 6 Tests with 6x500ml flasks.	22250.00
16.550.08	Unit for 6 Tests w/o flasks.	16000.00

**Spares :**

16.550.10	Fume Duct for 3 Tests, Glass.	3000.00
16.550.12	Fume Duct for 3 Tests, P.V.C.	1800.00
16.550.14	Fume Duct for 6 Tests, Glass.	4800.00
16.550.16	Fume Duct for 6 Tests, P.V.C.	2600.00
16.550.18	Flasks Kjeldhal plain neck. 300 ml.	300.00
16.550.20	Flasks Kjeldhal plain neck, 500 ml.	490.00
16.550.22	Flasks Kjeldhal plain neck, 800 ml.	600.00



16.550

**16.560 Kjeldhal Digestion Unit 'RELITECH'** same as Cat. No. 16.550 but with specially designed fume duct to totally avoid leakage of fumes with 24/29 cone adapters for openings suitable to fit Kjeldhal flasks having 24/29 Sockets but w/o flask. Kindly place order for kjeldhal flasks extra as per requirement.

Cat. No.	Description	Price/Piece (Rs.)
16.560.02	Unit for 3 Tests with 3x500ml Kjeldhal flasks	16750.00
16.560.04	Unit for 3 Tests with Fume Duct but w/o flasks.	12000.00
16.560.06	Unit for 6 Tests with 6 x 500ml Kjeldhal flasks.	27000.00
16.560.08	Unit for 6 Tests with Fume Duct but w/o flasks.	21250.00

**Spares :**

16.560.10	Specially designed Fume Duct with adapters, for 3 Tests for Cat. No.16.560.02 & 16.560.04	4950.00
16.560.12	Specially designed Fume Duct with adapters, for 6 Tests for 16.560.06 & 16.560.08	7500.00
16.560.14	Kjeldhal Flasks suitable for above units 300 ml. Capacity with 24/29 socket.	400.00
16.560.16	- do - 500 ml. with 24/29 socket.	520.00
16.560.18	- do - 800 ml. with 24/29 socket.	650.00

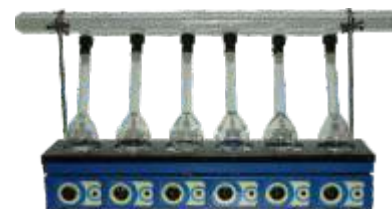

16.560



16.570



16.574



16.578



16.580



16.580.10



16.590.01



- 16.570 Kjeldhal Distillation Unit, 'RELITECH'**, Complete with mild steel tubular stand provided with one heating Box, Brass condenser rack with water circulation system, condenser clamps. Heater box is provided with top to receive Kjeldhal flasks, with electric heating elements of 500 watts each connected through individual on/off switches and energy regulators, supplied with or without glass parts.

Cat. No.	Description	Price/Piece (Rs.)
16.570.02	Unit for 3 Tests w/o glass parts	15750.00
16.570.04	Unit for 3 Tests with glass parts	24000.00
16.570.06	Unit for 6 Tests w/o glass parts	22500.00
16.570.08	Unit for 6 Tests with glass parts	37500.00

**Spares :**

- 16.570.10 Kjeldhal Distillation Unit Glass Parts** consisting of Kjeldhal flask 500 ml, multiple adapter, dropping funnel, Splash head, Liebig condenser, receiving adapter and receiving flask 250 ml. complete with standard joint fitting. 2550.00

- 16.574 Kjeldahl Digester :** These Digesters uses quartz infrared heaters for short heating time. Double Walled body made of epoxy Powder coated steel; working area is made of S.S. material. Specially designed fume exhaust system. Measure several varieties simultaneously at a time (4 / 8 / 12 holes) supplied complete with racks for holding the tubes. **Temp. Range :** Digital from +5° Ambient to 450°C ±1°C. **Digest Time :** 60-90 min/batch.

Cat. No.	No. of Tubes	Price/Piece (Rs.)
16.574.02	Unit for 4 tubes of 300 ml.	21500.00
16.574.04	Unit for 8 tubes of 300 ml.	28000.00
16.574.06	Unit for 12 tubes of 300 ml.	31000.00

- 16.578 Dry Bath Heating Block**

For Test Tubes, Micro Centrifuge tubes, etc. Digital temperature Controller from +5° C ambient to 200° C ± 1° C. Replaceable Aluminum block with cavities. Size of Cavities as per requirement.

Cat. No.	Description	Price/Piece (Rs.)
16.578.02	11mm x 25 Cavities	20750.00
16.578.04	13mm x 24 Cavities	20750.00
16.578.06	16mm x 20 Cavities	20750.00
16.578.08	19mm x 12 Cavities	20750.00
16.578.10	2 ml x 40 Cavities	23125.00
16.578.12	1.5 ml (MCT) x 48 Cavities	23125.00

**SOXHLET HEATING UNIT**

- 16.580 Soxhlet Extraction Heating Unit, 'RELITECH'**, Suitable for flasks of 100 ml, 150 ml., 250 ml. or 500 ml. Capacity Unit is supplied with Heating Box fitted with Heaters (Hot Plates or Heating Mantles) individual energy regulators, neon lights, etc. adjustable rod, clamps & boss heads, but without glass parts.

Cat. No.	Description	Price/Piece (Rs.)
16.580.02	Unit With 3 Hot Plate Type Heaters	12900.00
16.580.04	Unit With 6 Hot Plate Type Heaters	18500.00
16.580.06	Unit with 3 Mantle Type Heaters	11250.00
16.580.08	Unit with 6 Mantle Type Heaters	17250.00

- 16.580.10 Crude Fiber Estimation**, Hot Plate type for 6 Tests, complete with 6 x 1000 ml. Tall form beakers, 6 Bulb shape condensers, clamps and Connecting Rubber Tube. 31000.00

- 16.590 C.O.D. Digestion Apparatus, 'RELITECH'**, Aluminum Dry heating Block with 15 nos. cavities to accommodate 40 mm. dia tubes, heaters are placed below the block, ensures uniform heating, in a sheet metal housing, epoxy coated, temperature upto 200°C is controlled by digital temp. controller cum indicator, unit is fitted with timer, supplied with fifteen sets of glass reaction vessels and air condensers with standard joint fitting. 54000.00

- 16.590.01 Tubes, COD Digestion Tube 38 x 205mm with 24/29 socket** 300.00  
**16.590.03 Air Condenser, 1 mtr long with 24/29 cone for above tube.** 270.00  
**16.590.05 C.O.D for 6 glass reaction vessels (Same as 16.590)** 39000.00

**16.596 Heating Mantles, 'RELITECH'**, made of Knitted Glass Yarn, heaters are fitted beneath it, which provides uniform heating of flasks upto 400°C. The mantles are fitted in a nicely painted sheet metal case, filled with Glass Wool insulations, provided with an energy regulator, indicator and a cord.

Cat. No.	For Flask Capacity ml.	Watts	Price/Piece Rs.
16.596.02	50	60	2600.00
16.596.04	100	60	2650.00
16.596.06	250	150	2700.00
16.596.08	500	200	2800.00
16.596.10	1000	300	3350.00
16.596.12	2000	450	4150.00
16.596.14	3000	450	4950.00
16.596.16	5000	600	5700.00
16.596.18	10000	2x600	9800.00
16.596.20	20000	3x600	13500.00
16.596.22	50000	6x600	28000.00

**Spare Mantles With Heaters For Replacement :**

Cat. No.	Capacity (ml)	Watts	Price/Piece (Rs.)
16.596.24	50	60	600.00
16.596.26	100	60	600.00
16.596.28	250	150	600.00
16.596.30	500	200	700.00
16.596.32	1000	300	800.00
16.596.34	2000	450	1050.00
16.596.36	3000	450	1250.00
16.596.38	5000	600	1800.00
16.596.40	10000	2x600	2500.00
16.596.42	20000	3x600	4500.00
16.596.44	50000	6x600	10500.00
16.596.54	Temp. Control Unit with energy regulator, wire cord and multi socket of 5 amp and 15 amp		2100.00

**16.600 Hot Plates, 'RELITECH'**, Mounted on a thick M.S. sheet body, a smooth surface cast iron plate fitted with an electrically operated element laid under the plate. A three step rotary switch works on 220/230 volts A.C. controls heating. The plate is finished in heat resistant black and the body in stoved blue white painted.

Cat. No.	Type	Price/Piece (Rs.)
16.600.02	Round 20 cm dia approx, with energy regulator	4800.00
16.600.04	Round 20 cm dia approx with ER, SS Top	7400.00
16.600.10	Rectangular 30x25 cm, with energy regulator	8400.00
16.600.12	Rectangular 30x25 cm, with ER, SS Top	10900.00
16.600.14	Rectangular 40x25 cm, with energy regulator	9800.00
16.600.16	Rectangular 40x25 cm, with ER, SS Top	12800.00
16.600.18	Rectangular 45x30 cm, with energy regulator	10400.00
16.600.20	Rectangular 45x30 cm, with ER, SS Top	14900.00
16.600.22	Rectangular 45x60 cm, with energy regulator	17200.00
16.600.24	Rectangular 45x60 cm, with ER, SS Top	27000.00
16.600.26	Spiral type heater, round, with energy regulator	4800.00
16.600.30	Digital Temp. Controller cum Indicator with external probe to fit on above Hot Plates (Extra)	11500.00

**16.608 Laboratory Stirrers, 'RELITECH'**, Equipped with noiseless universal motor fitted with ball bearings, stainless steel stirring shaft fitted with three bladed propeller and retort stand having cast iron base, S.S. vertical and horizontal rods and a mount, continuous speed control for varying speed upto 4000 RPM.

Cat. No.	Description	Price/Piece Rs.
16.608.01	Shaft directly fitted to motor 1/20 HP	18000.00
16.608.02	Shaft fitted with drill chuck 1/8 HP	21500.00



16.596



16.600.02



16.600.10



16.600.12



16.608





16.612

- 16.612 Magnetic Stirrer, 'RELITECH'**, A Fractional Horse Power motor mounted in a sheet metal housing, fitted with speed regulator, max. Speed 1200 RPM. Top plate stainless steel, cap 1 to 5 litre, supplied with PTFE coated stirring bar.

Cat. No.	Description	Price/Piece Rs.
16.612.02	Without Hot Plate, Cap. 2 ltrs	6750.00
16.612.04	With Hot Plate and Energy regulator, Cap. 2 ltrs	7400.00
16.612.05	Digital Temp. & RPM indicator, Cap. 2 ltrs	23200.00
16.612.06	Without Hot Plate, Cap. 5 ltrs	9000.00
16.612.08	With Hot Plate and Energy Regulator, Cap. 5 ltrs	9500.00
16.612.09	Digital Temp. & RPM indicator, Cap. 5 ltrs	25450.00
16.612.10	Rotamantle with magnetic stirrer 2 Ltrs. Cap.	10500.00
16.612.12	Magnetic stirrer motorless single point	18500.00
16.612.14	Magnetic stirrer motorless with hotplate	24000.00



16.616

- 16.616 Water Baths Serological, 'RELITECH'**, Double Walled, outer Mild Steel Sheet, Epoxy Coated, Inner Chamber of Stainless Steel fitted with immersion heater, indicators, temperature upto 65°C is controlled by **Thermostat** or **PID Digital Temperature Indicator cum Controller**, supplied with lid and cord, but without racks.

Cat. No.	Inner Chamber mm	Controller	Price/Piece (Rs.)
16.616.01	300 x 175 x 175	Thermostat	11500.00
16.616.02	300 x 175 x 175	PID Digital	19500.00
16.616.03	300 x 250 x 175	Thermostat	12000.00
16.616.04	300 x 250 x 175	PID Digital	20000.00
16.616.05	375 x 300 x 175	Thermostat	16000.00
16.616.06	375 x 300 x 175	PID Digital	24000.00
16.616.07	450 x 300 x 175	Thermostat	18000.00
16.616.08	450 x 300 x 175	PID Digital	26000.00
16.616.09	600 x 300 x 175	Thermostat	21000.00
16.616.10	600 x 300 x 175	PID Digital	29000.00



16.620

- 16.620 Water Baths, 'RELITECH'**, Double Walled, Outer Mild Steel Sheet, Epoxy coated, Inner Chamber of Stainless Steel, Temp. is controlled by **Thermostat** or **PID Digital Temperature Indicator cum Controller** from ambient to 95°C, fitted with on/off switch, supplied with concentric rings and a cord.

Cat. No.	Inner Chamber cm	No. of Holes	Controller	Price/Piece Rs.
16.620.01	30x25x10	6	Thermostat	10500.00
16.620.02	30x25x10	6	PID Digital	21000.00
16.620.03	40x30x10	12	Thermostat	14000.00
16.620.04	40x30x10	12	PID Digital	24500.00
16.620.05	30x25x10(All SS)	6	PID Digital	26500.00
16.620.06	40x25x10(All SS)	12	PID Digital	30500.00



16.622

- 16.622 Precision Water Baths, 'RELITECH'**, Double Walled, outer Mild Steel Sheet, Epoxy Coated, Inner Chamber of Stainless Steel, fitted with immersion heater, Stirrer with speed regulator, Glass Window, Indicators and **PID Temperature Controller**. Temperature range 5°C above ambient to 100°C ± 0.1 °C. Supplied with cord.

Cat. No.	Inner Chamber mm	Price/Piece Rs.
16.622.02	425 x 250 x 225	44000.00
16.622.04	450 x 375 x 375	51000.00
16.622.06	600 x 450 x 450	63000.00

**16.628 Water Bath Incubator Shaker, 'RELITECH'**, Double Walled , Outer Mild Steel Sheet, Epoxy coated, Inner Chamber Stainless Steel, S.S. pyramidal lid. The bath has an oscillating tray on rollers, oscillated through geared variable speed motor, Oscillation, Speed range is between 40 to 140 cycles per minute. The shaking tray can either hold test tubes or conical flasks of 25 to 1000 ml. cap. (Cap. to be specified by the user, while ordering). Temperature is controlled by the **PID Temperature Controller ( $\pm 0.5^{\circ}\text{C}$ )**. Provided with a cord and plug to work on 220 / 230 VAC supply.

Cat. No.	Shaking Tray (W x D x H)	Temperature Range	Price/Piece Rs.
16.628.02	275 x 275 x 150 mm	+5°C ambient to 100°C	53750.00
16.628.04	405 x 300 x 150 mm	+5°C ambient to 100°C	67500.00
16.628.12	275 x 275 x 150 mm	5° to 100°C	92500.00
16.628.14	405 x 300 x 150 mm	5° to 100°C	105000.00



16.628

**16.630 Water Bath Universal, 'RELITECH'**, Temp. is controlled by Digital Temperature Indicator cum Controller, double walled, stainless steel chamber, one pyramidal lid and the other rectangular with holes covered with concentric rings, provided with water over flow arrangement, immersion heater, pilot lamp and on/off switch.

Cat. No.	Inner Chamber mm	Price/Piece Rs.
16.630.02	300 x 225 x 175	24500.00
16.630.04	450 x 300 x 175	27500.00

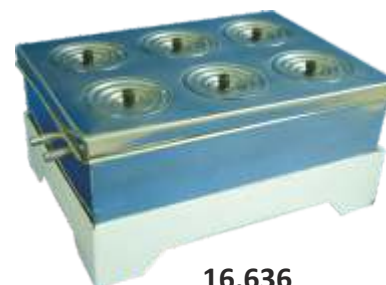

16.636

**16.636 Water Bath Rectangular, 'RELITECH'**, Single Walled Stainless Steel Chamber, Stainless steel top with holes and concentric rings, water over flow arrangement, rests on an angle iron frame. It is fitted with an immersion heater which is self ejecting on getting dry.

Cat. No.	Inner Chamber	Price/Piece Rs.
16.636.02	6 holes of 7.5 cm dia (300 x 250 x 100 mm)	6200.00
16.636.04	12 holes of 7.5 cm dia (350 x 400 x 100 mm)	8600.00



16.640

**16.640 Cylindrical Oil Bath, 'RELITECH'**, Double walled, inner chamber of stainless steel, temp. range 50° to 300°C, temperature is controlled by Digital Temperature Indicator cum Controller

Cat. No.	Capacity	Watts	Price/Piece Rs.
16.640.02	for 1 Liter flask	500	14500.00
16.640.04	for 2 Liter flask	1000	15100.00
16.640.06	for 3/5 Liter flask	1500	16700.00
16.640.08	for 10 Liter flask	2000	21000.00

**16.644 Melting Point Apparatus, 'RELITECH'**. A metallic heating block heated with superior quality element. A focusable lens, a shadowless lamp., regulator to control the heat. Unit is housed in a cast metal., pannel fitted with neon light, on/ off switch and regulator, knob and a thermometer holding rod.



16.644

**16.648 Digital Melting Point Apparatus, 'RELITECH'**, Designed for accurate determination of melting points of solid samples. Apparatus comprises of Cylindrical Silicon oil bath, built in magnetic stirrer with speed controller, electronic heat controller, Digital Temp. display with PT 100 sensor, Glare free background light with adjustable light intensity, provision for holding the melting point display. **Temp.range 2° above RT-250°C  $\pm 1.0^{\circ}\text{C}$**

Cat.No.	Description	Price/Piece Rs.
16.648.02	3½ digit LED $\pm 1.0^{\circ}\text{C}$	30250.00
16.648.04	4½ digit LED $\pm 0.1^{\circ}\text{C}$	36900.00



16.648



16.652



16.655



16.660



16.662

**16.652 Water Stills, Manesty Type, 'RELITECH'**, Complete stainless steel body, electrically operated, easily replaceable immersion type heaters and wall mounting arrangement.

Cat. No.	Output	Heater (kW)	Price/Piece Rs.
16.652.02	Approx. 2 Litre/Hr.	2 kW	9500.00
16.652.04	Approx. 3/4 Litre/Hr.	2 x 2 kW	10850.00
16.652.06	Approx. 6 Ltr/Hr.	3 x 2 kW	13750.00

**16.655 Automatic Pipette Washer, 'RELITECH'** 63 cm. high, 15 cm. dia. Approx. Stainless Steel. Cylindrical Jar with symphon system, water inlet and outlet and a pipettes holding device **9000.00**

**16.660 Oven Universal 'RELITECH'** Double walled, outer body M.S. Sheet epoxy coated, Glass Wool insulation, in between elements on three sides, fitted with **Thermostat or PID Digital Temperature Indicator cum Controller** to control temp. +5°C ambient to 250°C, Synthetic Rubber/ Fibre gasket at door, adjustable shelves, indicators, and on/off switch to work on 220/230 volts A.C., supplied with cord.

Cat. No.	Inner Chamber mm	Controller	Price/Piece Rs.
16.660.01	SS : 300 x 300 x 300	Thermostat	18000.00
16.660.02	SS : 300 x 300 x 300	PID Digital	29000.00
16.660.03	SS : 350 x 350 x 350	Thermostat	18900.00
16.660.04	SS : 350 x 350 x 350	PID Digital	28900.00
16.660.05	SS : 450 x 450 x 450	Thermostat	26000.00
16.660.06	SS : 450 x 450 x 450	PID Digital	36000.00
16.660.07	SS : 600 x 450 x 450	Thermostat	39000.00
16.660.08	SS : 600 x 450 x 450	PID Digital	49000.00
16.660.09	SS : 600 x 600 x 600	Thermostat	46500.00
16.660.10	SS : 600 x 600 x 600	PID Digital	56500.00

(Air circulating fan can be fitted in each size if required at an extra cost of Rs. 4800.00 and for ovens of 300°C, 25% will be charged extra. Other sizes of Ovens also available)

**16.662 Incubator Universal 'RELITECH'** Double walled, outer body M.S. Sheet, epoxy coated, Glass wool Insulation in between the chamber and outer body, fitted with **Thermostat or PID Digital Temperature Indicator cum Controller** to control temp. +5° Ambient to 80°C ± 1°C. Door has double viewing window, with adjustable shelves, indicators, on/off switch, work on 220/230 volts, supplied with cord.

Cat. No.	Inner Chamber mm	Controller	Price/Piece Rs.
16.662.01	SS : 300 x 300 x 300	Thermostat	18500.00
16.662.02	SS : 300 x 300 x 300	PID Digital	28500.00
16.662.03	SS : 350 x 350 x 350	Thermostat	19400.00
16.662.04	SS : 350 x 350 x 350	PID Digital	29500.00
16.662.05	SS : 450 x 450 x 450	Thermostat	26700.00
16.662.06	SS : 450 x 450 x 450	PID Digital	36700.00
16.662.07	SS : 600 x 450 x 450	Thermostat	39700.00
16.662.08	SS : 600 x 450 x 450	PID Digital	49700.00
16.662.09	SS : 600 x 600 x 600	Thermostat	47300.00
16.662.10	SS : 600 x 600 x 600	PID Digital	57300.00

(Air circulating fan can be fitted in each size if required at an extra cost of Rs. 4800.00. Other Sizes of Incubators also available)

**16.663 BOD Incubator, 'RELITECH'**, Unit with double walled construction with inner chamber of SS Sheet (304 grade) and outer body made of MS Sheet duly epoxy powder coated. The gap between the outer and the inner wall is filled with PUF insulation for minimal thermal losses. Two air circulation fans are fitted at the back of the Inner Chamber for maintaining temperature uniformity. Inner transparent door facilitate viewing inside the chamber without disturbing the temperature. The double walled door is provided with magnetic synthetic gasket and lock & key arrangement. Hermetically sealed compressor is mounted on Heavy MS angle frame at the bottom of the unit. The Control Panel is provided with separate indicators for Mains, Heating and Cooling. The complete unit is mounted on Castor wheels and supplied with SS wire mesh shelves, cord and plug to work on 220/230 AC supply.

Cat. No.	Inner Chamber cm	No. of Holes	Controller	Price/Piece Rs.
16.663.02	450 x 410 x 610	112 ltr (4 cu. ft.)	2	85000.00
16.663.04	505 x 415 x 830	171 ltr (6 cu. ft.)	2	95000.00
16.663.06	570 x 550 x 875	275 ltr (10 cu. ft.)	3	114000.00
16.663.08	650 x 580 x 900	336 ltr (12 cu. ft.)	3	125000.00
16.663.10	700 x 650 x 900	400 ltr (15 cu. ft.)	4	140000.00

**Optional Accessories at extra cost :**

16.663.20	Interior illumination with Florescent Tubes	10000.00
16.663.22	Automatic Timer	7500.00
16.663.24	Voltage Stabilizer	14000.00

**16.664 Laboratory Autoclave Vertical, 'RELITECH'**, Electrically operated, double walled. Boiler made of stainless steel, outer Stainless Steel lined, S.S. Lid, having radial locking system. Working pressure 5 p.s.i. to 15 p.s.i. safety valve; Complete with water level indicator, control box fitted with automatic pressure control switch, pressure gauge, steam release valve; pilot lamp, on / off switch for operation on 220 volts A/C main. Complete with Stainless Steel Basket.

Cat. No.	Boiler (Depth x Dia) mm	Price/Piece Rs.
16.664.02	450 x 250	70500.00
16.664.04	500 x 300	82500.00
16.664.06	550 x 350	97500.00
16.664.08	600 x 450	124500.00
16.664.10	750 x 550	160350.00

**Optional Accessories at extra cost :**

16.664.20	Lower Water Cutoff Device	9200.00
16.664.22	Digital Temperature Controller	10500.00
16.664.24	Digital Temperature Controller with Timer	13550.00

**16.665 Portable Autoclave, 'RELITECH'**, Suitable for general laboratory & field sterilization of instruments & dressing etc. Lid is provided with dial pressure gauge. Spring loaded safety valve, dead weight type safety valve & steam release valve. Fitted with jointless neoprene gasket for leak proofing.

Cat. No.	Size (mm) Dia. x Ht.	Capacity Ltrs	Material	Price/Piece Rs.
16.665.02	300 x 300	25	Aluminium	8500.00
16.665.04	300 x 300	25	Stainless Steel	12000.00
16.665.06	300 x 375	32	Stainless Steel	13600.00

**16.668 Vortex Shaker, 'RELITECH'**, Vibration type, variable speed, neoprene cup impart vigorous agitation to tubes, with touch on/off switch.

**16.668.03** Vortex Shaker, same as above but with Multiple Tube Adapter 8000.00

**16.672 V.D.R.L. Shaker, 'RELITECH'**, Platform 300 x 300 mm., variable speed, supplied with cord and plug to work on 220/230 volts AC. 9900.00



16.663



16.664



16.665

16.668



16.672

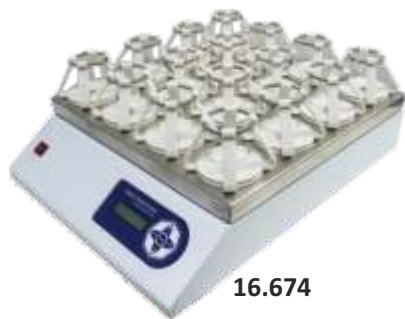

16.674



16.675



16.676



16.680



16.684

**16.674 Rotary Shaker, 'RELITECH'**, Designed for continuous shaking of solutions in Erlenmeyer Flasks from 50 to 1000ml capacity. It is compact bench type Table Top model with platform fitted with Lotus Clamps mounted on crank shafts to give an orbital motion to the flasks, within a diameter of approximately 50mm. Speed is controlled by speed controller upto 250 RPM. To work in 220/230 volts AC supply.

Cat. No.	Platform Size	Price/Piece Rs.
16.674.05	18" x 18"	36000.00
16.674.10	24" x 24"	49500.00
16.674.05 D	18" x 18" (with Digital RPM & Timer)	47000.00
16.674.10 D	24" x 24" (With Digital RPM & Timer)	62500.00

**16.675 Blood Sample Mixer, 'RELITECH'** for through mixing of Blood Samples and Cell suspensions, Keep the content in gentle motion while rolling. Exterior body MS coated, rolling speed 10-30 RPM, supplied with cord and plug to work on 220 V.

Cat. No.	Size	Price/Piece Rs.
16.675.04	With 4 Rollers	7000.00

**16.676 Ultrasonic Cleaner (Sonicator)** : Microprocessor based digital timer, Water heater with Digital Temperature Controller, automatic frequency tuning, ultrasonic frequency  $33 \pm 3$  KHz, autodegassing, SS tank and housing, fitted with drain valve, supplied with basket.

Cat. No.	Tank Size approx.	Cap. (approx.)	Price/Piece (Rs.)
16.676.02	230 x 140 x 100 mm	2.5 ltrs	32625.00
16.676.04	300 x 150 x 100 mm	3.5 ltrs	46125.00
16.676.06	200 x 200 x 120 mm	5 ltrs	59625.00
16.676.08	300 x 150 x 150 mm	6.5 ltrs	61875.00
16.676.10	300 x 230 x 150 mm	10 ltrs	78200.00
16.676.12	455 x 300 x 150 mm	21 ltrs	131625.00
16.676.14	375 x 375 x 100 mm	25 ltrs	147375.00
16.676.16	470 x 270 x 150 mm	30 ltrs	158625.00

**Note:** Higher capacity other than above mention is also available as per customer requirement.

**16.680 Rectangular Muffle Furnace 'RELITECH'** (Laboratory model) Light Weight, Outer casing made of thick PCRC sheet, duly powder coated, heating elements made of kanthal. A-1 wire are wound on the ceramic muffle, ceramic fibre insulation is provided on all sides. Temperature control unit consists of Digital Temperature Indicator cum Controller, fitted on the front with two pilot lamps, one pyrometer, thermocouple, silver thermal fuse, main lead with power plug to work on 220 / 230 volts or 400 / 440 volts A.C. Max. Temperature is 1000°C, working temperature 900°C.

Cat. No.	Muffle Size (W x H x D)	Price/Piece Rs.
16.680.02	100 x 100 x 225mm	30250.00
16.680.04	125 x 125 x 300mm	37500.00
16.680.06	150 x 150 x 300mm	39000.00
16.680.08	200 x 200 x 300mm	54500.00

**16.684 Vacuum Oven, 'RELITECH'**, Double walled with Outer M.S. sheet duly epoxy coated and inner made up of heavy gauge S.S. sheet. Gap between the two is filled with high grade glasswool to avoid thermal loss. Temp. range 50° to 150°C  $\pm 1^\circ\text{C}$ , fitted with digital controller cum indicator. Unit is capable of withstanding high vacuum. Provided with vacuum gauge, see through transparent window of toughened glass and one shelf. Works on 220 / 230 volts A.C. Supplied without Vacuum Pump.

Cat. No.	Dia x Depth	Price/Piece Rs.
16.684.02	250x250mm	49000.00
16.684.04	300x300mm	56700.00

(The above ovens can also be supplied with P. I. D. instead of Digital Temperature Indicator cum Controller at an extra cost of Rs. 7200.00 each.)

**MICRO PIPETTES**

**17.700 Variable Volume Micro pipette**, with Digital Display, stream lined tip ejector, two step operation, click stop, easy adjustment of volume by turning the plunger, autoclave able tip.

Cat. No.	Volume (l)	Inc. l	Vol l	Acc. (± %)	CV (≤ %)	Price/ Piece Rs.
17.700.04	0.5-10	0.1	0.5	5.0	2.8	2200.00
			5.0	1.5	0.8	
			10.0	1.0	0.4	
17.700.06	2-20	0.1	2.0	5.0	1.5	2200.00
			10.0	1.0	0.6	
			20.0	1.0	0.3	
17.700.08	5-50	1.0	5.0	2.5	6.0	2200.00
			25.0	0.7	1.5	
			50.0	0.7	0.7	
17.700.10	10-100	1.0	10.0	2.5	2.8	2500.00
			50.0	0.8	0.8	
			100.0	0.8	0.4	
17.700.12	20-200	1.0	20.0	2.5	1.5	2500.00
			100.0	1.0	0.6	
			200.0	0.6	0.3	
17.700.14	100-1000	10.0	100.0	1.6	0.3	2500.00
			500.0	0.6	0.2	
			1000.0	0.5	0.2	
17.700.16	0.5-5 ml	100.0	500.0	1.5	0.3	2850.00
			2500.0	0.6	0.2	
			5000.0	0.6	0.2	
17.700.18	1-10 ml	100.0	1000.0	1.5	0.3	2850.00
			5000.0	0.6	0.2	
			10000.0	0.6	0.2	

**17.700A Variable Volume Micro pipette, FULLY AUTOCLAVABLE**, with Digital Display, stream lined tip ejector, two step operation, click stop, easy adjustment of volume by turning the plunger, .

Cat. No.	Volume (l)	Inc. l	Vol l	Acc. (± %)	CV (≤ %)	Price/ Piece Rs.
17.700A.04	0.5-10	0.1	0.5	5.0	2.8	4050.00
			5.0	1.5	0.8	
			10.0	1.0	0.4	
17.700A.06	2-20	0.1	2.0	5.0	1.5	4050.00
			10.0	1.0	0.6	
			20.0	1.0	0.3	
17.700A.08	5-50	1.0	5.0	2.5	6.0	4050.00
			25.0	0.7	1.5	
			50.0	0.7	0.7	
17.700A.10	10-100	1.0	10.0	2.5	2.8	4250.00
			50.0	0.8	0.8	
			100.0	0.8	0.4	
17.700A.12	20-200	1.0	20.0	2.5	1.5	4250.00
			100.0	1.0	0.6	
			200.0	0.6	0.3	
17.700A.14	100-1000	10.0	100.0	1.6	0.3	4250.00
			500.0	0.6	0.2	
			1000.0	0.5	0.2	
17.700A.16	0.5-5 ml	100.0	500.0	1.5	0.3	4500.00
			2500.0	0.6	0.2	
			5000.0	0.6	0.2	
17.700A.18	1-10 ml	100.0	1000.0	1.5	0.3	4500.00
			5000.0	0.6	0.2	
			10000.0	0.6	0.2	



17.700



17.700A

Liquid Handling Equipment



N.700

**N.700 Variable Volume Micro pipette**, with Digital Display, stream lined tip ejector, two step operation, click stop, easy adjustment of volume by turning the plunger, autoclave able tip. With **NABL** Certificate.

Cat. No.	Volume ( l )	Inc. l	Vol l	Acc. (±%)	CV (≤%)	Price/ Piece Rs.
N.700.08	5-50	1.0	5.0	2.5	6.0	3300.00
			25.0	0.7	1.5	
			50.0	0.7	0.7	
N.700.10	10-100	1.0	10.0	2.5	2.8	3600.00
			50.0	0.8	0.8	
			100.0	0.8	0.4	
N.700.12	20-200	1.0	20.0	2.5	1.5	3600.00
			100.0	1.0	0.6	
			200.0	0.6	0.3	
N.700.14	100-1000	10.0	100.0	1.6	0.3	3600.00
			500.0	0.6	0.2	
			1000.0	0.5	0.2	
N.700.16	0.5-5 ml	100.0	500.0	1.5	0.3	3900.00
			2500.0	0.6	0.2	
			5000.0	0.6	0.2	
N.700.18	1-10 ml	100.0	1000.0	1.5	0.3	3900.00
			5000.0	0.6	0.2	
			10000.0	0.6	0.2	



N.700A

**N.700A Variable Volume Micro pipette**, FULLY AUTOCLAVABLE, with Digital Display, stream lined tip ejector, two step operation, click stop, easy adjustment of volume by turning the plunger. With **NABL** Certificate.

Cat. No.	Volume ( l )	Inc. l	Vol l	Acc. (±%)	CV (≤%)	Price/ Piece Rs.
N.700A.08	5-50	1.0	5.0	2.5	6.0	5100.00
			25.0	0.7	1.5	
			50.0	0.7	0.7	
N.700A.10	10-100	1.0	10.0	2.5	2.8	5100.00
			50.0	0.8	0.8	
			100.0	0.8	0.4	
N.700A.12	20-200	1.0	20.0	2.5	1.5	5100.00
			100.0	1.0	0.6	
			200.0	0.6	0.3	
N.700A.14	100-1000	10.0	100.0	1.6	0.3	5700.00
			500.0	0.6	0.2	
			1000.0	0.5	0.2	
N.700A.16	0.5-5 ml	100.0	500.0	1.5	0.3	5600.00
			2500.0	0.6	0.2	
			5000.0	0.6	0.2	
N.700A.18	1-10 ml	100.0	1000.0	1.5	0.3	5600.00
			5000.0	0.6	0.2	
			10000.0	0.6	0.2	

**17.710 Fixed Volume Micro pipette**, with Digital Display. stream lined tip ejector. Two step operation.

Cat. No.	Volume l	Acc. (± %)	CV (≤ %)	Price/ Piece Rs.
17.710.06	5.0	1.5	0.8	1600.00
17.710.08	10.0	1.0	0.5	1750.00
17.710.10	20.0	0.5	0.3	1750.00
17.710.12	25.0	0.5	0.3	1750.00
17.710.14	50.0	0.3	0.3	1750.00
17.710.16	100.0	0.3	0.2	1750.00
17.710.18	200.0	0.3	0.2	1750.00
17.710.20	250.0	0.3	0.2	1750.00
17.710.22	500.0	0.3	0.2	1750.00
17.710.24	1000.0	0.3	0.2	1750.00
17.710.26	2000.0	0.3	0.2	1800.00
17.710.28	5000.0	0.3	0.2	1950.00
17.710.30	10000.0	0.3	0.2	1950.00

**17.710A Fixed Volume Micro pipette**, FULLY AUTOCLAVABLE, with Digital Display. stream lined tip ejector. Two step operation.

Cat. No.	Volume l	Acc. (± %)	CV (≤ %)	Price/ Piece Rs.
17.710.06	5.0	1.5	0.8	2400.00
17.710.08	10.0	1.0	0.5	2400.00
17.710.10	20.0	0.5	0.3	2400.00
17.710.12	25.0	0.5	0.3	2400.00
17.710.14	50.0	0.3	0.3	2400.00
17.710.16	100.0	0.3	0.2	2400.00
17.710.18	200.0	0.3	0.2	2400.00
17.710.20	250.0	0.3	0.2	2400.00
17.710.22	500.0	0.3	0.2	2400.00
17.710.24	1000.0	0.3	0.2	2400.00
17.710.26	2000.0	0.3	0.2	2400.00
17.710.28	5000.0	0.3	0.2	2700.00
17.710.30	10000.0	0.3	0.2	2700.00

**N.710 Fixed Volume Micro pipette**, with Digital Display. stream lined tip ejector. two step operation. With **NABL** Certificate

Cat. No.	Volume l	Acc. (± %)	CV (≤ %)	Price/ Piece Rs.
N.710.08	10.0	1.0	0.5	2500.00
N.710.10	20.0	0.5	0.3	2500.00
N.710.12	25.0	0.5	0.3	2500.00
N.710.14	50.0	0.3	0.3	2500.00
N.710.16	100.0	0.3	0.2	2500.00
N.710.18	200.0	0.3	0.2	2500.00
N.710.20	250.0	0.3	0.2	2500.00
N.710.22	500.0	0.3	0.2	2500.00
N.710.24	1000.0	0.3	0.2	2500.00
N.710.26	2000.0	0.3	0.2	2500.00
N.710.28	5000.0	0.3	0.2	2700.00
N.710.30	10000.0	0.3	0.2	2700.00



17.710



17.710A



N.710





N.710A



17.720

17.730



17.732



17.740



17.745

**N.710A Fixed Volume Micro pipette**, FULLY AUTOCLAVABLE, with Digital Display, stream lined tip ejector. two step operation. With **NABL** Certificate

Cat. No.	Volume l	Acc. (± %)	CV (≤ %)	Price/ Piece Rs.
N.710A.08	10.0	1.0	0.5	3300.00
N.710A.10	20.0	0.5	0.3	3300.00
N.710A.12	25.0	0.5	0.3	3300.00
N.710A.14	50.0	0.3	0.3	3300.00
N.710A.16	100.0	0.3	0.2	3300.00
N.710A.18	200.0	0.3	0.2	3300.00
N.710A.20	250.0	0.3	0.2	3300.00
N.710A.22	500.0	0.3	0.2	3300.00
N.710A.24	1000.0	0.3	0.2	3300.00
N.710A.26	2000.0	0.3	0.2	3300.00
N.710A.28	5000.0	0.3	0.2	3600.00
N.710A.30	10000.0	0.3	0.2	3600.00

**17.720 Multichannel (Eight) Micro pipette**, with Digital Display, stream lined tip ejector, two step operation, easy adjustment of volume by turning the plunger.

Cat. No.	Capacity Range	Price/ Piece Rs.
17.720.02	5 to 50 l	24000.00
17.720.04	30 to 300 l	24000.00

**17.730 Tips for Micro pipette.**

Cat. No.	Capacity	Color	Pk. Size	Price/Pk Rs.
17.730.02	upto 200 l	Yellow	1000	360.00
17.730.04	upto 1000 ml	Blue	500	400.00
17.730.06	upto 5000 ml	White	100	900.00

**17.732 Stand for Micro pipettes, 5 places**

**1350.00**

**17.740 Bottle Top Dispensers:** All parts which comes in contact with reagents are made of PTFE, FEP and Borosilicate Glass, so can be used for all Laboratory Reagents dispensing needs. High accuracy and precision is ensured through several stages of strict quality checks during manufacturing. Each Dispenser is calibrated in accordance with ISO 8655 Standard, and supplied with certificate.

**Product Information :**

Piston : PTFE  
 Cylinder : Glass  
 Value Housing : Polypropylene  
 Value Assembly : Glass  
 Volume adjustment : Screw Type  
 Delivery Tube : FEP  
 Inlet Tube : FEP

Compatibility : Excellent with all reagents except HF.

Each dispenser is supplied with 1 standard adapter of 30 mm thread and 5 adapters of 28, 32, 36, 40 & 45 mm. to fit in most of the reagent bottles in Laboratories.

**Note : Instrument is fully autoclave able.**

Cat. No.	Volume ml.	Increment ml	Accuracy		CV		Price/ Piece Rs.
			± %	± ml	± %	± ml	
17.740.02	0.25 - 2.5	0.05	0.6	0.015	0.20	0.005	18500.00
17.740.04	0.5 - 5	0.1	0.5	0.025	0.10	0.005	18500.00
17.740.06	1 - 10	0.2	0.5	0.05	0.10	0.01	18500.00
17.740.08	2.5 - 30	0.5	0.5	0.15	0.10	0.03	20500.00
17.740.10	5 - 60	1	0.5	0.30	0.10	0.06	20500.00
17.740.12	5 - 60	1	0.5	0.30	0.10	0.06	27000.00

**17.745 Pipette Pump Acrylonitrile Butadiene Styrene (ABS).**

Cat. No.	Capacity (ml.)	Price/Piece Rs.
17.745.02	2	480.00
17.745.04	10	480.00
17.745.06	25	540.00

**17.750 Electronic Pipette Filling Device**

17200.00

An efficient and reliable to suit all types of Pipetting needs.

**Features :**

- Continuous adjustment of pump speed during operation.
- Silicon collet suitable to hold firmly upto 100 ml. pipettes.
- Membrane filter provided prevents Aerosol Contamination and liquid to enter the device.
- Rechargeable Ni-MH batteries used in combination with the low power circuit and Vacuum/Pressure Pump, allows 8 hr. continuous operation.
- Battery charge is provided with each piece.
- Two LEDs to show Low charging and charging status.

❖ **ELECTROPHORESIS**

**17.770.01 Electrophoresis Horizontal-MINI**

14800.00

It is required in biotechnology, Molecular Biology applications in Colleges, Universities, Research Institutes etc. It is meant for Nucleic Acid (DNA-RNA) characterization. These are also called Submarine Electrophoresis Unit/ Agrose Gel (Mini Size). The unit is jointless, moulded of transparent Polycarbonate to avoid leakage. The unit includes buffer chamber, safety lid with cables and standard accessories.

**17.770.03 Electrophoresis Vertical-MINI**

14800.00

It is required in biotechnology, Molecular Biology application in colleges, Universities, Research Institutes. It is meant for protein characterization. The unit is jointless, moulded of transparent Polycarbonate to with Acrylic cover. Supplied complete with standard accessories.

**17.770.05 Electrophoresis Digital Microprocessor based Power Supply**

32000.00

programmable, 0-300 V and 0-200 mA with timer 1 minute to 09 hrs. 59 minutes 20 memories can be saved. 3 units can be run simultaneously.

**17.770.07 Electrophoresis Power Supply Analog, Fixed**

14200.00

Analog model with fixed 250mA and also fixed voltage 50V, 100V, 150V, 200V and 250V. It is recommended for mini Horizontal and mini Vertical Electrophoresis Apparatus.

❖ **FILTER PAPERS**

**18.101 Filter Paper, RELIGLAS, Qualitative. No. 1, Pack of 100 Circles.**

Cat. No.	Size	Price/Piece Rs.
18.101.03	7 cm dia.	125.00
18.101.05	9 cm dia.	180.00
18.101.07	11 cm dia.	190.00
18.101.09	12.5 cm dia.	240.00
18.101.11	15 cm dia.	375.00
18.101.21	46 x 57 cm.	2950.00

**18.201 Membrane Paper, Cellulose Acetate, 0.45 or 0.22µ, Pack of 100 Circles.**

Cat. No.	Size	Price/ Piece Rs.
18.201.05	25 mm dia.	2150.00
18.201.07	47 mm dia.	2600.00



17.750



17.770.01



17.770.03



17.770.05



17.770.07



18.101



18.201

Electrophoresis/ Filter Papers

<b>A</b>			
Adapters	48-52		
Agate Mortar & Pestle	95		
Air Condensers	44		
Air Leak Tube	52		
Albumometer	69		
Alcohol Distillation	57		
Alcohol Pipette	9		
Allihn Condensers	45		
Ammonia Distillation	56		
Anaerobic Culture Jars	99		
Anderson Pipette	75		
Arsenic Apparatus	81		
Aspirator	30, 87		
Assemblies	56-59		
Autoclave	107		
Automatic Pipette Washer	106		
Automizer Bulb	98		
<b>B</b>			
B.O.D. Bottles	31		
Ball & Socket	47		
Ball & Socket Clip	47		
Basin, Silica/ Quartz	81-82		
Baths	104-105		
Beakers	26, 82, 85, 86		
Bell Jar	32		
Bladder, Gas Sampling	98		
Blood Cell Counter	69		
Blood Sample Mixer	108		
Blood Sugar Tubes	25		
BOD Incubator	107		
Boiling Flask	36-37		
Boss Heads	91		
Bottle, Mobile Phase	28		
Bottle, Schlenk type	43		
Bottle Top Dispensers	112		
Bottles	27-31, 71, 72, 86, 87		
Buchner Flasks	42		
Buchner Funnel	64, 87, 95		
Bulb Condenser	45		
Bulk Density Cylinder	20		
Burette Clamp	89, 90		
Burettes	1-5		
Burners	93		
Butyrometer	76		
<b>C</b>			
Cabinet Still	60		
Cal. Chloride Tower/Tubes	70		
Carbaryl Apparatus	57		
Carboy	86		
Carrying Tray	89		
Centrifuge Tube	23, 90		
Chiller	59		
Chloroform Bellow	98		
Chromatography Cabinet	99-100		
Chromatography Column	78-80		
Chromatography Sprayers	81		
Chromatography Tank	32, 99		
Chromatography Vials	76-78		
Clamps	89, 90-91		
Cleaver Apparatus	58		
Clinical Lab. Glassware	67-69		
Clips for Standard Joints	46		
COD Digestion Apparatus	102		
Coil Condensers	44-45		
Combustion Boat	83		
Combustion Flask	75		
Condensers	44-46		
Conductivity Cell	75		
Cone for Holding Thermo.	84		
Cones	46		
Cones, Imhoff	21		
Conical Flasks	33-35, 42, 82		
Connectors, Tubing	70, 87		
Conway Type Diffusion	69		
Couplin Jar	69		
Cork Borers	93		
Counting Chamber	68		
Cover Glasses	38		
Crimping Tool	78		
Crow Receiver	20		
Crucible Tongs	93		
Crucibles	64, 82		
Crude Fibre Estimation	102		
Crystallizing Dishes	31		
Culture Flask	34		
Culture Jars	32		
Culture Tubes	21-22		
Cuvette	83		
Cyanide Distillation Apparatus	57		
Cylinder, Measuring	16-21, 89		
<b>D</b>			
Dairy & Milk Testing App.	76		
Davies Condensers	45		
Dean & Stark Apparatus	58		
De-crimping Tool	78		
Dessicator	32, 87		
Digestion Tube	25, 102		
Dispenser, Bottle Top	112		
Dirt Correction	75		
Dishes	31		
Dissolution Bowl	75		
Distillation Apparatus	56-63		
Distillation Flask	36		
Double Surface Condenser	45		
Double Walled Flask	44		
Draining Rack	89, 95		
Dropper	72		
Dropping Bottles	30, 71-72		
Dropping Funnels	55-56		
Dry Bath Heating Block	102		
Drying Tray	69		
Drying Tube	52		
Durham Tube	25		
<b>E</b>			
Electrophoresis	113		
Embedding Molds	69		
Embedding Rings	69		
Erlenmeyer Flasks	33, 35, 42		
ESR Pipette	9		
Essential Oil Determination	58		
Ether Condensers	46		
Evaporating Dish	31		
Evaporators, Rotary	100		
Expansion Adapters	48		
Extractors	57		
<b>F</b>			
Face Masks	90		
Filter Apparatus	64-66		
Filter Cone	98		
Filter Flask	35, 42		
Filter Holders, SS	65		
Filter Paper	113		
Filter Pump	75		
Filter Tubes	75		
Filtering Funnel	33, 82		
Flask, Schlenk type	43		
Flask Stand	38, 87, 98		
Flasks	10-15, 33-43, 80-83		
Flasks, Volumetric	10-15, 83		
Flat Bottom Flask	37, 39		
Float Rack	88		
Florentine Flask	43		
Fluoride Determination	57		
Forceps	94		
Friedrich Condensers	45		
Funnels	33, 64, 88		
Funnel Holder	89		
Furnace, Muffle	108		
<b>G</b>			
Gas Analysis	70-71		
Gas Collecting Tubes	70-71		
Gas Desorber	70		
Gas Generator Kipp's	71		
Gas Inlet Tube	52		
Gas Jar	71		
Gas Sampling Bladder	98		
Gas Tap	94		
Gas Washing Bottles	71		
Glass Cuvette	83		
Glass Spreader	68		
Gloves, Disposable	90		
Gooch Crucible	64		
<b>H</b>			
Haematocrit Capillaries	67		
Haemocytometer	68		
Haemometer	68		
Haffkine Flask	37		
Hand Grip	98		
Heat Exchanger	59		
Heating Block	102		
Heating Mantle	103		
Hoffman's Screw Clip	94		
Hoffman's Voltmeter	75		
Hot Plate	103		
HPLC Vials	76-78		
Hydroxypropoxy Assembly	57		
Hygrometer	84		
<b>I</b>			
Imhoff Cone	21		
Impinger	70		
Incubator	106, 107		
Incubator Shaker	104		
Inland Revenue Condenser	45		
Inoculating Loop Holder	69		
Iodine flask	35		
<b>J</b>			
Jack, Laboratory	90		
Jars	32		
Joints, Standard	46		
<b>K</b>			
Karl Fisher Burette	5		
Kettles-Resin Reaction	37		
Kipp's Apparatus	71		
Kjeldahl Digestion App.	101-102		
Kjeldahl Digestion Tubes	25, 102		
Kjeldahl Digestor	102		
Kjeldahl Dist. Assembly	58, 59		
Kjeldahl Flask	36, 43		
Kjeldahl Distillation App.	101-102		
Kohlraush Flask	15		
<b>L</b>			
Laboratory Jack	90		
Laboratory Metal Ware	90-95		
Laboratory Stirrer	103		
Lactometer	76		
Lechatelier Flask	15		

Liebig Condensers	44, 46	Pressure Equalizing Funnel	56	Still Head	49-50
Loop Holder	69	PTFE Laboratory Ware	85	Stirrer Bars	85
<b>M</b>		Pyknometers	29, 75	Stirrers	52, 103
Mac-Cartney Bottles	30	<b>Q</b>		Stirring Rod	72, 85, 89
Magnetic Needles	85	Quartz Cell	83	Stopcocks	66-67
Magnetic Stirrer	104	Quartz Distillation Unit	61-63	Stoppers	15, 47, 85
Mancozeb Assembly	57	Quartz Labware	81-83	Stuffing Box Gland	53
Markham Distillation Unit	58	<b>R</b>		Suba Seal Stoppers	97
Mat, Rubber/ Silicon	98	R.B.C. Pipette	68	Sugar Flask	15
Max.- Min. Thermometer	84	R.M. Value Apparatus	76	Sulphur Di-Oxide Assembly	57
MCT Box	88	Reaction Flask	37	Swabs	90
MCT Rack	88	Reagent Bottles	27-28, 86	Syringe Needle Destroyer	69
Measuring Cylinders	16-21, 89	Receiver Adapters	48-49	<b>T</b>	
Measuring Jugs	89	Recovery Head	49-50	Taps	94
Melting Point Apparatus	105	Rectangular Jar, Museum	32	Test Tub Holder	93
Melting Point Capillary	25	Reduction Adapters	48	Test Tube Stand	88, 95
Membrane Filter Assembly	66	Reichert Wollney's App.	76	Test Tubes	23-25
Membrane Filter Holder	65	Reservoir, Chromatography	80	Test Tube, Schlenk type	43
Membrane Filter Paper	113	Retort Rings	92	Thermometer Pocket	52
Methoxy Assembly	57	Reverse Osmosis Unit	59, 61, 62	Thermometers	83-84
Micro Capillary Pipettes	67	Rings, Weights for Flasks	16	Thiele's MP Tube	72
Micro Pipettes	109-112	Rocking Platform	69	Thistle Funnel	33
Micro Pipette Stand	112	Rotatable Multi Rack	69	Tilt Measure	9
Micro Slide	67-68	Rotary Evaporator	100	Tips, Micropipette	112
Micro Spatula	94	Rotary Mixer	69	Tissue Homogeniser	69
Milk Pipette	9	Rotary Shaker	108	TLC Kit	99
Mixer, Blood Sample	108	Round Bottom Flask	36-42	Tongs	93
Mobile Phase Bottle	28	Rubber Cone	97-98	Traps	50-51
Moisture Determination	58	Rubber Cork	98	Trays, Laboratory	89
Mojjonier Flask	76	Rubber/ Silicon Mat	98	Trays, Drying	69
Mortar & Pestle, Agate	95	Rubber/ Silicon Sheet	98	Trypsinising Flask	34
Mud Flask	15	Rubber Teat	98	Tubes	21-25
Muffle Furnace	108	Rubber Tubing	96	<b>U</b>	
Multi Channel Pipette	112	<b>S</b>		U.V. Cabinet	100
Multiple Adapters	48	Safety Rider for Vol. Flask	16	Ultrasonic Cleaner	108
<b>N</b>		Sampling Tube (Dip Tube)	75	Universal Multi Rack	88
Nessler Cylinder	21	Schlenk, Tube/Flask/Bottle	43	Urine Container	90
Nessler Cylinder Stand	88, 95	Schoinger Combustion Flask	75	<b>V</b>	
<b>O</b>		Scoop	28, 95	V.D.R.L. Shaker	107
Oil Bath	105	Sedimentation Cone	21	V.D.R.L. Slides	68
Oil Centrifuge	23	Sedimentation Pipette	75	Vacuum Manifold	44
Oven	106, 107	Separating Funnels	53-55	Vacuum Oven	108
Oxygen Combustion Flask	75	Separating Funnel Holder	89	Vacuum Pumps	66
<b>P</b>		Shaker	104, 107, 108	Vials & Closures	76-78
Paper Chrom. Cabinet	99	Sheet, Rubber/ Silicon	98	Viscometer	72-74
Pasteur Pipette	9, 90	Silica Basins/ Crucibles	81-82	Voltmeter, Hoffman's	75
Petri Dish Box	94	Silica Triangle	83	Volumetric Flask	10-15, 83
Petri Dishes	31, 88	Silicon Bulb	10, 98	Vortex Shaker	107
Petroleum Flask/ Jar	15	Silicon Stoppers	97	<b>W</b>	
pH Electrode, Glass	75	Silicon Tubing	96	W.B.C. Pipette	68
Pipette Box	89, 94	Sintered Glassware	64-66	Wash Bottles	76, 87
Pipette Bulbs	10, 98	Slide Mailer	90	Watch Glass	72
Pipette Filler	98	Slides	67-68	Water Baths	104-105
Pipette Filling Device	113	Sockets	46	Water Distillations/ Still	59-63
Pipette Pump	112	Soxhlet Extraction	57	Water Softner	59, 61, 62
Pipette Stand	89, 112	Soxhlet Extraction Unit	102	Water Still	59-63, 106
Pipette, Tips	112	Spatulas	94, 98	Water Taps, Swan neck	94
Pipette Washer	106	Specific Gravity Bottles	29	Weighing Bottles	28-29
Pipettes	5-9, 90, 109-112	Specimen Jars	32	Weighing Scoop	28
Plastic Laboratory Ware	86-90	Spirit Lamp	94	Wintrobe Tubes	25
Polarimeter Tube	74	Splash Head	49-50	Wire Gauge	93
Polenske's Apparatus	76	Sprayers	81	Witt's Apparatus	65
Police Man, Silicon Rubber	98	Spreader	68	Wouff Bottles	30
Porcelain Buchner Funnel	95	Staining Rack, SS	69		
Portable Autoclave	107	Staining Trough	69		
Pour Point Tube	21	Stalganometer	74		
Powder Funnel	33, 88	Stand for Micro Pipette	112		
Power Supply	113	Stands (Retort, Tripod etc.)	89, 92		
PP/ PTFE Stoppers	15, 85	Sterility Test Unit, SS	65		
		Sterilizer (Autoclave)	107		