



Volume-I

2022

PRISTINE BIOMEDICAL

CB 201, Suite #6, Guru Harkishan Plaza
Industrial Area, Naraina Ring Road
New Delhi 110028

Ph: +91 965 427 3263, +91 888 278 0325
info@pristinebiomedical.com, pristbio@gmail.com
<https://www.pristinebiomedical.com>

Freezer Racks & Inventory Systems



Upright Freezer Racks



Chest Freezer & LN2 Racks



Canisters, Frames & Dividers

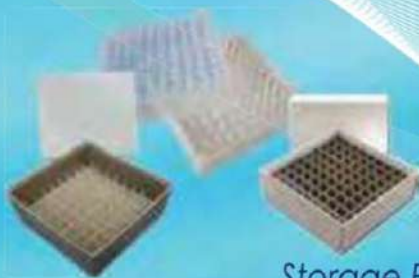

Storage Boxes

Maximizing storage space conveniently and efficiently.

Vertical Racks for Chest Freezer & Liquid Nitrogen Tanks

(Locking Rod Included)

For Standard 2" Boxes

- ◆ Racks are for standard 2" cardboard (white or yellow), plastic (Polypropylene or polycarbonate) or metal (stainless or aluminum) boxes.
- ◆ Constructed of corrosion resistant stainless steel.
- ◆ Security lock devices are available for each rack.



Vertical Rack



Handle & Locking System

StarChill high performance chiller racks

Maintain a fridge environment on the benchtop! The centre section of StarChill racks changes colour when frozen. It then gradually turns back to its original colour as it warms up, thus giving an instant, visual-indication of the temperature.



Stainless Steel Freezer Racks (Vertical Type) (HS CODE : 7326 9090)

Cat No.	Type	Description	Packing	Price
712-108	Vertical type for Cryo Box 2 Inch	1x4	1	2750
712-109	Vertical type for Cryo Box 2 Inch	1x5	1	3375
712-110	Vertical type for Cryo Box 2 Inch	1x7	1	4688
712-111	Vertical type for Cryo Box 2 Inch	1x9	1	6063
712-112	Vertical type for Cryo Box 2 Inch	1x10	1	6750
712-113	Vertical type for Cryo Box 2 Inch	1x12	1	8000
712-114	Vertical type for Multiwell Plates	25 places	1	5625

Ultra-thin Pol



Chemical-res



Label Printer: resistant to alcohol, xylene, ethylene, hot water bath etc. $\pm 220^{\circ} \text{C}$

Upright Freezer Racks

For Standard 2" Boxes

- ◆ Racks are for standard 2" cardboard (white or yellow), plastic (polypropylene or polycarbonate) or metal (stainless or aluminum) boxes.
- ◆ Constructed of corrosion resistant stainless steel.
- ◆ Security lock devices are available for each rack.

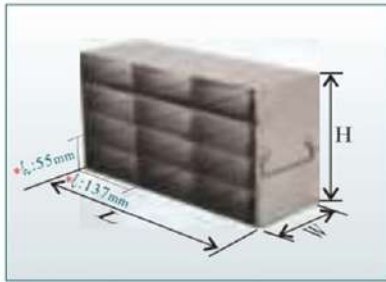

Rack Only



Rack w/Cardboard Box



Rack w/Metal Box



Rack w/Polycarbonate Plastic Box



w/DP Lock Device Option



Stainless Steel Freezer Racks (Upright Frame Type) (HS CODE : 7326 9090)				
Cat No.	Type	Description	Pack	Price
712-115	Upright Frame type for Cryo Box 2 Inch	3x3	1	6188
712-116	Upright Frame type for Cryo Box 2 Inch	3x4	1	8125
712-117	Upright Frame type for Cryo Box 2 Inch	3x5	1	7813
712-118	Upright Frame type for Cryo Box 2 Inch	4x3	1	8125
712-119	Upright Frame type for Cryo Box 2 Inch	4x4	1	10875
712-120	Upright Frame type for Cryo Box 2 Inch	4x5	1	11563



Racks with side access for use in upright freezers have a handle on either end (For use with all standard storage boxes up to 136 x 136 x 55 mm)





Tissue culture
Jam Bottle

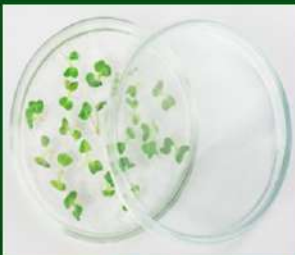

Petri Dish



50ml falcon



cardboard
cryo box



Nitrile
Gloves



Microplate
sealing roller

Pristine Biomedical

CB 201 (Suite #6), Guru Harkishan Plaza,
Industrial Area, Naraina Ring Road, New Delhi 110028
Ph: +91 96 542 73263, +91 98 713 98048
Email:pristbio@gmail.com www.pristinebiomedical.com



the brand apart - a strand apart

Resource Persons - Lab Products Division, Pristine Biomedical



Indu Sharma
+91 888 278 0325



Arvind Sahu
+91 704 236 1410



Piyali Das
+91 965 427 3263



Prakash Shah
+91 885 152 0875

Pristine Biomedical employs under privileged or not-so-privileged individuals from very remote & unreachable parts of India, trains them, hires them & tries to make them efficient.



TABLE OF CONTENTS

2022

PRISTINE BIOMEDICAL

CB 201, Suite #6, Guru Harkishan Plaza
Industrial Area, Naraina Ring Road
New Delhi 110028

Ph: +91 965 427 3263, +91 888 278 0325
info@pristinebiomedical.com, pristbio@gmail.com
<https://www.pristinebiomedical.com>

TABLE OF CONTENTS

(SEQUENTIAL ARRANGEMENT OF TITLES AS PER THEIR PAGE NUMBER)

PRISTINE BIOMEDICAL THE BRAND APART, THE STRAND APART		
SL. NO	DESCRIPTION	PAGE NO
1	FREEZER RACKS & INVENTORY SYSTEMS	1
2	CONTAINER SEAL	3
3	DOT LABELS & STRIPS	3
4	CRYO-BABIES AND CRYO-TAGS	4
5	PETRI SEAL	4
6	DURA SEAL	5
7	INDICATOR TAPE FOR STEM AUTOCLAVE	5
8	SAINT GOBIN BENCH PROTECTOR	6
9	SPILFYTER LAB SOAKER	6
10	SAINT GOBIN CHEMWARE BOILING STONES	7
11	HIGH TEMPRATURE INDICATOR TAPE	5
12	HIGH-LOW TEMPRATURE INDICATOR TAPE	7
13	LABORATORY MARKERS	7
14	AUTOCLAVABLE BAGS	8
15	BIOHAZARD BAGS	8
16	LABORATORY LABELLING TAPE	8
17	RESEALABLE BAGS WITH ZIP LOCK	9
18	SAFETY GOGGLES	9
19	SAFETY GOGGLES BOX	9
20	PARTICULATE RESPIRATOR	10
21	SAFETY FACE SHIELD	10
22	TEMPRATURE RESISTANT GLOVES	10
23	CRYO GLOVES	11
24	FOOT PROTECTION	11
25	FACE MASK	12
26	HEAD COVER	12
27	DISPOSABLE COVERALLS	14
28	LABCOAT DISPOSABLES	13
29	KIMTECH WIPERS	14
30	GLOVE BOX HOLDER	16
31	HAND SANITIZER	16
32	PARAFILM DISPENSER	17

PRISTINE BIOMEDICAL THE BRAND APART, THE STRAND APART		
SL. NO	DESCRIPTION	PAGE NO
33	PARAFILM M	16
34	WORKSPACE STORAGE BINS	17
35	FREEZER THERMOMETER	18
36	LABORATORY BURNER	18
37	BETA RADIATION WIZARD	19
38	BIOHAZARD WASTE CONTAINER	19
39	SAMPLE BAGS	19
40	FUNNEL	20
41	STAINLESS STEEL FREEZER RACKS	20
42	HEAVY DUTY ASPIRATORS	21
43	MEASURING CYLINDER	21
44	REAGENT RESERVOIR	21
45	ARA HARVEST BASE WELLS	22
46	PTFE BEAKER	22
47	REAGENT BOTTLE (NARROW MOUTH)	23
48	VOLUMETRIC FLASK CLASS A	23
49	REAGENT BOTTLE (WIDE MOUTH)	24
50	REAGENT BOTTLES GLASS	24
51	BEAKER	25
52	SOLUTION BOTTLES	25
53	DESICCATORS VACUUM	26
54	WASH BOTTLE	26
55	BOTTLE TOP DISPENSERS	27
56	HAND OPERATED VACUUM PUMP	28
57	PETRI DISH	28
58	VACUUM FILTRATION APPARATUS-GLASS	28
59	PCR TUBES	30
60	PCR PLATES	30
61	SEALING FILM / MAT ROLLER	31
62	MULTI CAVITY SEED DISPLAYER	31
63	BREEDING JAR MOSQUITO	31
64	ACRYLIC LABELS (FIELD)	31
65	ACRYLIC LABELS T SHAPE	31
66	GREEN NETS FOR SUNROOF (PRICE/2 FEETS)	31

TABLE OF CONTENTS

(SEQUENTIAL ARRANGEMENT OF TITLES AS PER THEIR PAGE NUMBER)

PRISTINE BIOMEDICAL THE BRAND APART, THE STRAND APART			PRISTINE BIOMEDICAL THE BRAND APART, THE STRAND APART		
SL. NO	DESCRIPTION	PAGE NO	SL. NO	DESCRIPTION	PAGE NO
67	PLANT IDENTIFICATION PEGS	31	101	PLANTATION POTS	43
68	SOIL PH METER	31	102	MICROPIPETTES	44
69	HAEMOCYTOMETER	31	103	SEALING FILM PLEARACBLE	44
70	ELECTRIC BAG SEALER	31	104	SEALING FILM FOR CELL CULTURE PLATES	45
71	LAB COAT COTTON WASHABLE	31	105	SEALING FILM FOR COLD STORAGE	45
72	KINEMATIC VISCOSITY BATH DIGITAL	31	106	MULTIWELL SEALING PADS	46
73	BENCHTOP MINI COOLERS	32	107	CULTURE TUBE	46
74	PCR RACK WITH COVER	32	108	CELL CULTURE DISH GLASS	47
75	PCR WORKERBENCH RACK	32	109	INOCULATION LOOPS & SPREADERS	48
76	BOX FOR MICRO CENTRIFUGE TUBES	33	110	CELL CULTURE DISH, GLASS BOTTOM	48
77	CARDBOARD CRYO BOX	33	111	SYRINGE FILTERS	49
78	MULTI USE RACK	33	112	MEMBRANE FILTERS	51
79	CRYO BOX (PC)	34	113	FILTER PAPERS	52
80	CRYO BOX (PP)	34	114	PRISTINE LATEX EXAM GLOVES	53
81	CRYO VIALS	34	115	PRISTINE LITE NITRILE GLOVES	53
82	CRYO WORKSTATION	35	116	VINYL GLOVES	53
83	WIRE RACK	35	117	SAFESKIN PURPLE NITRILE GLOVES	54
84	RACK FOR 15ML/ 50ML CENTRIFUGE TUBE	35	118	MICROFLEX GLOVES	55
85	RACK FOR 50ML TUBE	35	119	CENTRIFUGE TUBES	56
86	RACK FOR MICRO CENTRIFUGE TUBES	36	120	MICROCENTRIFUGE TUBES	57
87	MICROCENTRIFUGE TUBE RACKS	36	121	PESTLE	58
88	REVERSIBLE RACK	36	122	SERUM SAMPLE CRYOGENIC VIALS	58
89	CENTRIFUGE TUBE RACK 50ML	37	123	SPECIMEN TUBES	58
90	TEST TUBE STAND	37	124	STORAGE VIALS	58
91	UNIVERSAL RACK	37	125	PIPETTE FILTER	59
92	ELISA PLATE	38	126	SEROLOGICAL PIPETTES	59
93	SEROLOGICAL PLATE	38	127	PASTEUR PIPETTES	60
94	CELL CULTURE FLASKS	39	128	PLANT GROWTH REGULATOR	60
95	DEEPWELL PLATE	39	129	VACCUM FILTERATION APPARATUS	60
96	CELL CULTURE PLATE	41	130	BIO-SOIL / SOIL CONDITIONER	61
97	CELL CULTURE DISH	42	131	SILWET / VAC-IN-STUFF	61
98	CAP FOR JAM BOTTLE	43			
99	MAGENT BOX TRANSPARENT	43			
100	TISSUE CULTURE JAM BOTTLE	43			

TABLE OF CONTENTS

(SEQUENTIAL ARRANGEMENT OF TITLES AS PER THEIR PAGE NUMBER)

PRISTINE BIOMEDICAL THE BRAND APART, THE STRAND APART			PRISTINE BIOMEDICAL THE BRAND APART, THE STRAND APART		
SL. NO	DESCRIPTION	PAGE NO	SL. NO	DESCRIPTION	PAGE NO
132	LABORATORY IDENTIFICATION	62	163	BIOLOGICAL INDICATORS	87
133	LABORATORY LABEL PRINTER	62	164	CHEMICAL INDICATORS	88
134	MICROPLATE SHAKER	66	165	PPE KIT (PERSONAL PROTECTIVE EQUIPMENT)	89
135	ORBITAL SHAKER	67	166	MICROTIP BOXES	89
136	MAGNETIC STIRRER	68	167	MICROTIPS (PIPETTE TIPS)	90
137	MICROCENTRIFUGE	68	168	MICROTIPS (FILTER TIPS)	90
138	ELECTROPHORESIS SYSTEM HORIZONTAL	69	169	MANUAL SPRAYER HEAVY DUTY	91
139	ELECTROPHORESIS SYSTEMS-VERTICAL	71	170	SAFETY TOUCH KEY	92
140	BLOTTING SYSTEMS (SEMI DRY ELECTROBLOTTERS)	72	171	INFRARED THERMOMETER	92
141	POWER SUPPLIES	73	172	OXYGEN KIT WITH MASK	93
142	AGAROSE FOR ELECTROPHORESIS	74	173	DIGITAL THERMOMETER	93
143	LABORATORY SPATULA	79	174	GLOBAL POSITIONING SYSTEM	94
144	DRY BATH MINI	67	175	SURVEYING & MAPPING SOFTWARE	94
145	ORBITAL SHAKER	67	176	ELECTRONIC THEODOLITE	94
146	X-TRACTA GEL EXTRACTION TOOL	77	177	AUTOMATIC LEVEL EXPLORER (AUTO LEVEL)	94
147	GERMINATION PAPER	78	178	MICRO OPTIC THEODOLITE	94
148	MANNUAR	78	179	DISTANCE METER PD SERIES	94
149	PARAFIN COATED (WAX) PAPER	78	180	CROSS LINE LASER ACL SERIES	95
150	BLOTTING PAPER	78	181	LASER PLUMMET RC-10SERIES	95
151	LABORATORY SPATULA	79	182	ROTARY LASER ML-101 SERIES	95
152	MICROCOVER GLASSES	80	183	DIGITAL PLANIMETER	95
153	OPTICA CELLS (CUVETTES)	80	184	CONCRETE TEST HAMMER	95
154	TEST SIEVES	82	185	PLATE & PRISM HOLDER	95
155	SMARTCOAT DECONTAMINANTS	84	186	BRUNTON COMPASS	95
156	DISINFECTANT SPRAY	84	187	GEOLOGICAL HAMMER	95
157	DNA DEGRADATION SOLUTION	85	188	MEASURING WHEEL	95
158	RNA DEGRADATION SOLUTION	85	189	G.P.S. GARMIN TELESCOPIC SPECIAL STAND	95
159	COTTON ROLLS	85	190	FOR TOTAL STAND & ELECTRONIC THEODOLITE	96
160	LAB UTILITY TRAY	86	191	LEVELING STAVES	96
161	THERMO CONDUCTIVE RACK	86	192	FIBRE GLASS TELESCOPIC STAFF	96
162	CONTACTLESS HAND SANITIZER	86	193	SUNSHINE RECORDER COMPLETE WITH CHART	96

TABLE OF CONTENTS

(SEQUENTIAL ARRANGEMENT OF TITLES AS PER THEIR PAGE NUMBER)

PRISTINE BIOMEDICAL THE BRAND APART, THE STRAND APART			PRISTINE BIOMEDICAL THE BRAND APART, THE STRAND APART		
SL. NO	DESCRIPTION	PAGE NO	SL. NO	DESCRIPTION	PAGE NO
194	SUNSHINE BALL	96	223	FREEMAN MEASURING WHEEL DIGITAL	98
195	PRISMATIC COMPASS	96	224	CORE CUTTER WITH RAMMER & DOLLY	98
196	SURVEY COMPASS	96	225	IMPACT TESTING MACHINE WITH COUNTER	98
197	DIGITAL SOIL MOISTURE METER	97	226	SLUMP TEST APPARATUS COMPLETE	98
198	DIGITAL WIRELESS WEATHER STATION	97	227	SAND REPLACEMENT METHOD (IN MM)	98
199	DIGITAL TONG TESTER	97	228	CUBE MOULD 15 X 15 X 15 CM	98
200	DIGITAL ANEMOMETER	97	229	CBR MOTORIZED CUM HAND OPERATED	98
201	ALCOHOL TESTER	97	230	MARSHALL STABILITY MOTORIZED CUM HAND OPERATED (COMPLETE WITH ALL ACCESSORIES)	98
202	SOUND LEVEL	97	231	DIAMOND CORE CUTTER WITH DIESEL ENGINE	98
203	DIGITAL ALTIMETER	97	232	DIAL THERMOMETER FOR BITUMEN	99
204	DIGITAL INSULATION TESTER	97	233	WOOD MOISTURE METER (DIGITAL)	99
205	INFRARED MOISTURE METER	97	234	RAPID MOISTURE METER (SOIL MOISTURE METER)	99
206	POWER GUARD	97	235	VERNIER CALIPERS	99
207	DIGITAL INCLINOMETER	97	236	MICROMETER	S99
208	DIGITAL DEPTH GAUGE	97	237	ELECTRONIC BALANCE 1 GM TO 10 KG	99
209	MANOMETER	97	238	TENT "ARCTIC" NYLON WITH POLE & HANGER	99
210	DIGITAL MULTIMETER	97	239	RUCK SACK	99
211	DIGITAL MULTIMETER POCKET SIZE, MULTIFUNCTION, DATA HOLD	97	240	LIFE JACKET	99
212	STERO SCOPE	97	241	SLEEPING BAG	99
213	PARALLEX BAR (STEREO METER)	97	242	JACKET REVERSIBLE	99
214	INSTRUMENT BOX OF 5 PARTS	97	243	NAGA/ CAMMO/ ON 21/ PARA PATTERN	99
215	INSTRUMENT BOX OF 13 PARTS	97	244	JACKET WIND PROOF	99
216	MINI DRAFTER EXPORT QUALITY	97	245	CAMMO/ GT PATTERN	99
217	SHEET HOLDER (KEEPING THE DRAWING SHEET)	97	246	POUNCHOOS	99
218	ENGINEER PLANE TABLE COMPLETE STANDARD	97	247	SHOES: DMSF/ DMSL/ PARA PATTERN	99
219	ENGINEER PLANE TABLE COMPLETE EXPORT	97	248	CAP FOR FIELD/BALCALAVA / BARRAY	99
220	RAIN GAUGE RECORDING WITH MEASURING JAR	97			
221	FREEMAN TAPE 15 METER	98			
222	FREEMAN MEASURING WHEEL	98			

TABLE OF CONTENTS

(SEQUENTIAL ARRANGEMENT OF TITLES AS PER THEIR PAGE NUMBER)

PRISTINE BIOMEDICAL THE BRAND APART, THE STRAND APART			PRISTINE BIOMEDICAL THE BRAND APART, THE STRAND APART		
SL. NO	DESCRIPTION	PAGE NO	SL. NO	DESCRIPTION	PAGE NO
249	GLOVES: IMPORTED	100		COMPRESSION TESTING	
250	PH/TEMP./MV METER	100	275	MACHINE COMPLETE WITH CALIBRATION REPORT	102
251	PHOTO COLORIMETER&FILTERS	100	276	VICAT NEEDLE APPARATUS	103
252	HEMOGLOBIN METER	100	277	CONCRETE TEST HAMMER	103
253	COND., TDS&TEMP.METER	100	278	FLASH AND FIRE TEST APPARATUS	103
254	SALINITY METER	100	279	TAR VISCOMETER COMPLETE SET	103
255	COLONY COUNTER	100	280	SOFTENING POINT TEST APPARATUS	103
256	TURBIDITY METER	100	281	PYCNOMETER BOTTLE	103
257	NEPHELOMETER	100	282	SOIL PERMEABILITY TEST APPARATUS COMPLETE SET	103
258	AUTO KARI FISHER TITRIMETER	100	283	STANDARD PENETROMETER	103
259	MICROPROCESSOR BASED D.O METER	100	284	VANE SHEAR APPARATUS	103
260	DIGITAL DISSOLVED OXYGEN	100	285	DUCTILITY TEST APPARATUS COMPLETE SET	103
261	MICROPROCESSOR BASED WATER&SOIL ANALYSIS KIT	100		SPECIFIC GRAVITY	
262	SPECTROPHOTOMETER	100	286	APPARATUS (BUOYANCY BALANCE)	103
263	DIGITAL CONDUCTIVITY METER	100	287	VIBRATING TABLE	103
264	FLAME PHOTOMETER	100	288	CRUSHING VALUE APPARATUS	103
265	TELE THERMOMETER WITH VETERINARY PROBS	100	289	DENSITY BASKET	103
266	MELTING POINT APPARATUS	100	290	BLAIN AIR PERMEABILITY APPARATUS	103
	UV_VIS		291	RAMMER FOR CORE CUTTER	103
267	SPECTROPHOTOMETER DOUBLE BEAM	100	292	BULK AND DENSITY SET	103
268	VISCOMETER	101	293	AGGREGATE IMPACT TEST APPARATUS	103
269	DOMESTIC ADVANCED DIGITAL CIRCUIT	101	294	LIQUID LIMIT DEVICE	103
270	DIGITAL FRIABILITY TEST APPARTUS (SINGLE DRUM)	101	295	GAUGING TROWEL	103
271	MICROSCOPE	101		LOS ANGELES TEST	
272	BATTERY FOR ALL TOTAL STATION LIECA, TOPCON, TRIMBLE, NIKON, SOKKIA, LABLINE & SCIBIO ETC.	101	296	APPARATUS COMPLETE SET (FULL BODY)	103
273	CHARGER FOR ALL TOTAL STATION LIECA, TOPCON, TRIMBLE, NIKON, SOKKIA, LABLINE & SCIBIO ETC.	102	297	BITUMEN EXTRACTOR	103
274	UNIVERSAL TESTING MACHINE (UTM)	102	298	MOTORIZED SIEVE SHAKER	103
			299	SIEVES	103
			300	ENORSAND BAG	103
			301	PROCTOR MOULD AND RAMMER	103

TABLE OF CONTENTS

(SEQUENTIAL ARRANGEMENT OF TITLES AS PER THEIR PAGE NUMBER)

PRISTINE BIOMEDICAL THE BRAND APART, THE STRAND APART			PRISTINE BIOMEDICAL THE BRAND APART, THE STRAND APART		
SL. NO	DESCRIPTION	PAGE NO	SL. NO	DESCRIPTION	PAGE NO
302	SLUMP TEST APPARATUS COMPLETE SET	103	327	MORTAR MIXER FOR BITUMEN TEST	104
303	VEE BEE CONSISTOMETER - MOTORISED	104	328	DLC HAMMER MACHINE	104
304	MARSHAL STABILITY MACHINE	104	329	UNCONFINED COMPRESSION TESTING MACHINE	104
305	CORE DRILLING MACHINE	104		TRIAxIAL TESTING MACHINE	
306	COMPRESSOMETER	104	330	COMPLETE WITH ALL STANDARD	104
	CBR MACHINE SINGLE SPEED		331	AIR ENTERTAINMENT METER	104
307	COMPLETE WITH ALL STANDARD ACCESSORIES	104	332	BEAKER GRADUATED, LOW FORM	105
308	TILE ABRASION TESTING MACHINE COMPLETE	104	333	BEAKER GRADUATED, TALL FORM	105
309	EXTENSOMETER	104	334	B.O.D. BOTTLE	105
	DYNAMIC CONE		335	BURETTE WITH PINCH CORK	105
310	PENETROMETER COMPLETE SET	104	336	BURETTE WITH STRAIGHT GLASS STOPCOCK	105
311	RAPID MOISTURE METER PACKED IN WOODEN BOX	104	337	BURETTE SCREW ROTA FLOW STOPCOCK	105
312	COMPACTION FACTOR APPARATUS COMPLETE SET	104	338	CENTRIFUGAL TUBE PLAIN,	105
313	VIBRATING MACHINE GOOD QUALITY	104	339	CENTRIFUGAL TUBE GRADUATED	105
314	CONSOLIDATION TEST APPARATUS COMPLETE SET	104	340	CENTRIFUGAL TUBE WITH SCREW CAP	105
	DIRECT SHEAR TEST APPARATUS COMPLETE SET WITH PROVING RING AND DIAL GAUGE		341	CONDENSER LIE BIG PLAIN	105
315		104	342	CONDENSER LIE BIG WITH I/C JOINT	105
316	DOLLY CUTTER	104	343	CONDENSER ALLIHN WITH I/C JOINT	105
317	LENGTH GAUGE AND THICKNESS GAUGE SET	104	344	DISTILLATION FLASK R.B. SIDE TUBE	105
318	SAND REPLACEMENT APPARATUS	104	345	DISTILLATION APPARATUS AUTOMATIC	105
319	CUBE MOULD	104	346	AUTOMATIC CUT OFF DEVICE FOR ABOVE	105
320	LAB CONCRETE MIXER	104	347	DISTILLATION SET	105
321	PENSKY MARTIN FLASH & FIRE	104	348	DROPPING BOTTLE WITH PIPETTE STOPPER	105
322	REDWOOD VISCOMETER	104	349	R.D. BOTTLE WITH GLASS STOPPER	105
323	SAY VOLT VISCOMETER	104	350	FILTER FLASK PLAIN 'HEAVY FILTRATION	105
324	REAGENT FOR MOISTURE METER (CARBIDE CHEMICAL)	104	351	FLAT BOTTOM FLASK	105
325	PLASTIC LIMIT DEVICE	104	352	FLAT BOTTOM FLASK JOINT B	106
326	SHRINKAGE LIMIT	104		24/29	

TABLE OF CONTENTS

(SEQUENTIAL ARRANGEMENT OF TITLES AS PER THEIR PAGE NUMBER)

PRISTINE BIOMEDICAL THE BRAND APART, THE STRAND APART			PRISTINE BIOMEDICAL THE BRAND APART, THE STRAND APART		
SL. NO	DESCRIPTION	PAGE NO	SL. NO	DESCRIPTION	PAGE NO
353	FUNNEL	106	378	MEASURING CYLINDERS, I/C STOPPERD	107
354	FUNNEL BUCKNER WITH SINTERED DISC	106	379	NESSLERS CYLINDER	107
355	FOLIN TUBE BLOOD SUGAR TUBE	106	380	PETRI DISH	107
356	GOOCH CRUCIBLE G-1/G-2/G-3/G-4/G-5	106	381	PIPETTE GRADUATED	107
357	REAGENT BOTTLE N. M, AMBER COLOR	106	382	PIPETTE VOLUMETRIC	108
358	REFLUXE ASSEMBLY	106	383	REAGENT BOTTLE NARROW MOUTH	108
359	ROUND BOTTOM FLASK	106	384	REAGENT BOTTLE WIDE MOUTH	108
360	ROUND BOTTOM FLASK JOINT B 24/29,	106	385	REAGENT BOTTLE W. M. SCREW CAP	108
361	ROUND BOTTOM FLASK, TWO NECK	106	386	TEST TUBE STOPPER WITH JOINT	108
362	ROUND BOTTOM FLASK, THREE NECK	106	387	TEST TUBE PIGEONHOLE PACK	108
363	SEPARATING FUNNEL PTFE ROTA FLOW STOP COCK	106	388	TEST TUBE BOROSILICATE GLASS	108
364	SOXLETTE EXTRACTION APPARATUS	106	389	TEST TUBE GRADUATED	108
365	CONDENSOR GRAHAM COIL TYPE I/C JOINT	106	390	THISTLE FUNNEL	108
366	CONDENSER DOUBLE SURFACE	106	391	VICTOR MEYERS APPARATUS	108
367	CONICAL FLASK	107	392	VISCOMETER	108
368	CONICAL FLASK WIDE MOUTH	107	393	VOLUMETRIC FLASK SOLID STOPPER	108
369	CONICAL FLASK WITH JOINT B 24/29,	107	394	WEIGHING BOTTLE TALL FORM	108
370	CONICAL FLASK WITH SCREW CAP	107	395	WEIGHING BOTTLE SQUAT FORM	108
371	CULTURE TUBE MEDIA WITH SCREW CAP & RUBBER LINER ROUND / FLAT BOTTOM	107	396	SODA LIME GLASSEWARE	108
372	DESICCATORS PLAIN	107	397	A.P. BOTTLE (PNEUMOTHORAX BOTTLE)	108
373	DESICCATORS VACUUM	107	398	BEAKER GRIFFIN LOW FROM	108
374	IODINE FLASK	107	399	WINCHESTER BOTTLE	108
375	KIPPS APPARATUS	107	400	WOULF BOTTLES	109
376	MEASURING CYLINDERS ROUND BASE	107	401	BEAKER LOW FORM GRADUATED (SCREEN PRINTED)	109
377	MEASURING CYLINDERS HEXAG BASE	107	402	BATTERY JARS (DIA.XHT. CM) BELL JARS WITH KNOB & GROUND RIM (CLOSED AT TOP) (DIA.XHT. CM)	109
			403	BELL JARS WITH STOPPER ON TOP AND GROUND RIM (OPEN AT TOP)(DIA.XHT. CM)	109

TABLE OF CONTENTS

(SEQUENTIAL ARRANGEMENT OF TITLES AS PER THEIR PAGE NUMBER)

PRISTINE BIOMEDICAL THE BRAND APART, THE STRAND APART			PRISTINE BIOMEDICAL THE BRAND APART, THE STRAND APART		
SL. NO	DESCRIPTION	PAGE NO	SL. NO	DESCRIPTION	PAGE NO
405	BELL JAR KNOBBED (DIA.XHT. CM)	109	429	FLASK VOLUMETRIC STOPPER (MEASURING/STANDARD FLASK)	110
406	BOTTLE GAS WASHING DRESCHEL (PLAIN)	109	430	GOLD LEAF JAR	110
407	BURETTE WITH PINCH CLIP COMPLETE WITH RUBBER TUBE AND JETS	109	431	FUNNEL 60 ANGLE PLAIN DIA CM	110
408	BURETTE WITH STOPCOCK	109	432	GAS GENERATING APPARATUS KIPPS	110
409	BREAST PUMP	109	433	GAS JARS WITH GROUND FLANG AND FOOT WITHOUT LID DIA.XHT.CM	110
410	CRYSTALLIZING DISHES FLAT BOTTOM (SIZE IN CM)	109	434	GAS WASHING BOTTLE WITHOUT FITTING	110
411	CANADA BALSAM BOTTLE WITH GLASS ROD	109	435	GAS GENERATING KIPS APPARATUS COMPLETE WITH DELIVERY TUBE AND THISTLE FUNNEL	110
412	CALCIUM CHLORIDE TOWER	109	436	SPARE THISTLE FUNNEL & FITTING ONLY	111
413	CAVITY BLOCK SIZE MM	109	437	HYDROMETER JARS	111
414	COUPLING JAR	109	438	IODINE FLASK STOPPERED	111
415	BOTTLE WITH RUBBER TEAT AND GLASS DROPPER(ML)	109	439	JARS COPLIN WITH COVER	111
416	DROPPING BOTTLE WITH GALSS STOPPER (TKPATTERN)	109	440	JARS STAINING RECTANGULAR WITH COVER	111
417	DROPPING BOTTLE WITH GLASS STOPPER (T. KPATTERN,) AMBER COLOUR	109	441	LACHLANCHE CELL POST	111
418	DESICATORS WITH COVER	109	442	MEDICINE GLASS	111
419	DESICCATORS PYREX TYPE VACUUM	109	443	MORTARS AND PESTLES	111
420	DESICCATORS PYREX TYPE VACUUM	109	444	MEASURING CYLINDERS	111
421	ERLENMEYER FLASKS NARROW MOUTH CONICAL)	109	445	MEDIA BOTTLE COMPLETE WITH ALUMINUM CAP AND RUBBER WASHER	111
422	ERLENMEYER FLASK NARROW MOUTH CONICAL (SEREEN PRINTED)	110	446	URINE TEST GLASS GRADUATED	111
423	FLASK FLAT BOTTOM	110	447	PNEUMETIC TROUGH	111
424	FLASK ROUND BOTTOM	110	448	PETRI DISHES	111
425	FLASK R.B. LONG NECK (RETORTED)	110	449	PNUEATHORAX BOTTLES (A.P BOTTLE)	111
426	FLASK CONICAL	110	450	RT BOTTLES	111
427	FLASK IODINE	110	451	PIPETTE VOLUMETRIC ONE MARK (BULB TYPE)	111
428	FLASK FILTERING WITH TABULATURE AT SIDE HEAVY WALL	110	452	PIPETTE GRADUATED (MOHR TYPE)	111
			453	REAGENT BOTTLE	112

TABLE OF CONTENTS

(SEQUENTIAL ARRANGEMENT OF TITLES AS PER THEIR PAGE NUMBER)

PRISTINE BIOMEDICAL THE BRAND APART, THE STRAND APART		
SL. NO	DESCRIPTION	PAGE NO
454	LABORATORY TUBES & RODS	112
455	RAIN GAUGE CYLINDERS GRADUATED	112
456	SPIRIT LAMP	112
457	SPECIMEN TUBE	112
458	SPECIMEN JARS	112
459	SURGICAL ITEMS	113
460	ARTERY FORCEP S.S. ISI MARK	113
461	ACTIVITY GAUGE	113
462	ALICE TISSUE FORCEP	113
463	AMBU BAG +ROLLER	113
464	AMPOULE FILLING & SEALING MACHINE	113
465	AMPOULE WASHING	113
466	ANEMIA CAN	113
467	ANTIBIOTIC ZONE READER	113
468	ARTERY FORCEP	113
469	ASEPTIC CABINET	113
470	B.P INSTRUMENTS	113
471	B.P. BLADE	113
472	B.P. INSTRUMENTS STAND	113
473	BALL MILL	113
474	BANDAGE CUTTING SCISSOR	113
475	BED PAN	113
476	BED SIDE SCREEN	113
477	BOTTLE FILLING MACHINE	113
478	BOTTLE SEALING MACHINE	113
479	BOTTLE WASHING MACHINE	113
480	BOWL / BOUL	113
481	BULK DENSITY APPARATUS	113
482	CAPSULE COUNTER	113
483	CAPSULE FILLING	113
484	CENTRIFUGE MACHINE	113
485	CENTRIFUGE TUBE 25 ML	113
486	CHEATLE FORCEPS	113
487	CLINICAL THERMOMETER	113
488	COATING PAN	113
489	CONVULSO METER	113
490	D&C SET	113

PRISTINE BIOMEDICAL THE BRAND APART, THE STRAND APART		
SL. NO	DESCRIPTION	PAGE NO
491	D.T. MACHINE	113
492	DISSECTING FORCEPS	113
493	DIGITAL MELTING POINT APPARATUS	114
494	DIGITAL THERMOMETER	114
495	DISSOLUTION TEST APPARATUS	114
496	DISSOLUTION RPM	114
497	DISINTEGRATOR APPARATUS	114
498	DOUBLE CONE BLENDER WITH MOTOR	114
499	DOUBLE UNIT ORANGE BATH	114
500	DRESSING DRUM	114
501	DRESSING SCISSOR	114
502	EDDY HOT PLATE	114
503	EMERGENCY FLUORESCENT LIGHTING DOUBLE TUBE, 230 V	114
504	FETAL MONITOR PULSE METER	114
505	FOOTSTEP SS	114
506	FRIABILITY DIGITAL RPM	114
507	FROG BOARD	114
508	GLUCOMETER	114
509	HAND GRINDING MILL	114
510	HAND TORCH 3 CELL	114
511	HEART LEVER	114
512	HISTAMINE CHAMBER	114
513	HOSPITAL WHEELCHAIR FOLDING	114
514	HOT WATER BAG	114
515	INFUSION PUMP	114
516	INSTRUMENT STERILIZER	114
517	IUCD SET STAINLESS STEEL	114
518	IV STANDS FOR HOSPITAL, HEAVY DUTY	114
519	JUMPING BOX	114
520	KIDNEY TRAY	114
521	KOCHER FORCEPS	114
522	L.P. NEEDLE	114
523	LABORATORY	114
524	MAGNETIC STORM	114

TABLE OF CONTENTS

(SEQUENTIAL ARRANGEMENT OF TITLES AS PER THEIR PAGE NUMBER)

PRISTINE BIOMEDICAL THE BRAND APART, THE STRAND APART			PRISTINE BIOMEDICAL THE BRAND APART, THE STRAND APART		
SL. NO	DESCRIPTION	PAGE NO	SL. NO	DESCRIPTION	PAGE NO
525	MOSQUITO ARTERY FORCEPS	114	559	SUCTION CANNULA	115
526	MAYO SCISSORS	114	560	SURGICAL TRAY WITH COVER	115
527	MEDICINE TROLLY	114	561	SWIMMING TEST APPARATUS	115
528	MICROSCOPE BINOCULAR	114	562	T.L.C. KIT	115
529	MIXING VAT WITH STIRRER	114	563	TABLET COUNTER	115
530	MONSANTO TYPE TABLET HARDNESS TESTER	114	564	TAIL FLICK APPARATUS	115
531	NEEDLE DESTROYER	114	565	TEETH FORCEP	115
532	NEEDLE HOLDER	114	566	TELE THERMOMETER	115
533	OINTMENT SLAB	114	567	THUMB FORCEP	115
534	OPERATION TABLE	114	568	TINCHER PRESS	115
535	OUTLET FORCEP	115	569	TISSU HOMOZENISER	115
536	OXYGEN CYLINDER	115	570	TUBE FILLING	115
537	OXYGEN FLOW METER	115	571	U.V. CABINET SMALL	115
538	PEDIATRIC SUCTION MACHINE ELECTRIC	115	572	URIN PORT FEMALE/MALE	115
539	PASSIVE AVOIDANCE RESPONSE TEST APP.	115	573	VAGINAL RETRACTOR	115
540	TABLET HARDNESS TESTER PFIZER TYPE	115	574	VAGINAL SOEACULAM	115
541	POLE CLIMBING APPARATUS	115	575	VULSELLUM FORCEPS	115
542	POLISHING PAN	115	576	WEIGHT MACHINE	115
543	POSTMORTUM GLOVES(PAIR)	115	577	TEST SIEVE 8'BRASS	116
544	POSTMORTUM SET	115	578	RHIZON SAMPLERS	117
545	PUNCHING MACHINE	115	579	NEEDLES, STERILIZED	117
546	ROTA ROAD II -V CAMP	115	580	VACUUM TUBES, NO ADDITIVES	117
547	SHOCK BOX	115	581	SYRINGESET 10 ML	117
548	SIMPLE LEVER	115	582	WOODEN RETAINER	117
549	SINGLE UNIT ORANGE BATH	115	583	FEMALE CONNECTOR	117
550	SMOKING BURNER	115	584	INSERTION TOOL	117
551	SMOKING BURNER - KEROSENE	115	585	RHIOCERA, PLAIN	117
552	SPONGE HOLDING FORCEP	115	586	RHIZON IRRIGATOR	117
553	STETHOSCOPE	115	587	SYRINGE SET 5 ML AND RETAINER	117
554	STITCH CUTTING SCISSOR	115	588	RESERVOIRS FOR ROBOTIC SYSTEMS	118
555	STOMACH WASH TUBE	115	589	PIPETTE CAROSEAL (EPPENDORF PIPETTE HOLDER STAND)	118
556	STRECHER FOLDING MADE OF CANVAS	115	590	BIOLOGICAL STABILIZATION PRODUCTS	119
557	STRECHER WITH TROLLY	115	591	RNA STABLE	119
558	SUCTION APPARATUS	115	592	DNA STABLE	120

TABLE OF CONTENTS

(SEQUENTIAL ARRANGEMENT OF TITLES AS PER THEIR PAGE NUMBER)

PRISTINE BIOMEDICAL THE BRAND APART, THE STRAND APART			PRISTINE BIOMEDICAL THE BRAND APART, THE STRAND APART		
SL. NO	DESCRIPTION	PAGE NO	SL. NO	DESCRIPTION	PAGE NO
593	THREE LAYERED ALUMINIUM FOIL POUCH PLAIN	121	615	IMPORTED PARCHMENT PAPER BAG-SCINATION	125
594	LINT FREE WIPES	121	616	BUTTER PAPER BAG-SCINATION	125
595	LABORATORY APRON	122	617	MUSLIN CLOTH-SCINATION	125
596	PLASTIC BAG WITH LAMINATION	122	618	NYLON NET SELFING BAG-SCINATION	125
597	INSECT PROOF NYLON NETTING. UV STABILIZED	122	619	KRAFT SEED CONTAINER STAR PAPER-SCINATION	125
598	NYLON NET FOR BIRD PROTECTION	122	620	WATERPROOF ENVELOPES-SCINATION	125
599	UV STABILIZED POLYTHENE SHEET	122	621	GOLDEN YELLOW SEED PACKET-SCINATION	125
600	INSECT TRAP POLYTHENE BAG YELLOW COLOUR	122	622	YELLOW METAL FOLD SEED PACKET-SCINATION	125
601	PLASTIC WHITE FLY YELLOW TRAP	123	623	MARKIN CLOTH BAG-SCINATION	125
602	INSECT COLLECTION NET	123	624	MUSLIN CLOTH BAG-SCINATION	126
603	NYLON NET BAG	123	625	LUGGAGE LABLE-SCINATION	126
604	PLASTIC SHEET MULCHING	123	626	PLANT TAG WITH THREAD (TAG LABLE / PRICE LABLE)-SCINATION	126
605	U.V. STABILIZED RIGIDEX FILM	123	627	ALUMINIUM LABLE-SCINATION	126
606	OINTMENT SPATULAS	124	628	BIRD SCARING RIBBON-SCINATION	126
607	PLASTIC ARROW TYPE TREE LABEL	124	629	THRESHING SHEET DASUTI CLOTH-SCINATION	126
608	SEED PACKET TAG / HARVESTING TAG	124	630	TARPAULIN ASSORTED SIZE-SCINATION	126
609	POND LINING	124	631	COUNTING BOARD 50/100 HOLES-SCINATION	126
610	AUTOCLAVABLE BAG FOR MUSHROOM-SCINATION	124	632	ANATOMY STUDY MODELS	149
611	PLASTIC RING FOR MUSHROOM-SCINATION	124	633	MATHEMATICAL MODEL & KITS	154
612	TASSEL BAG-SCINATION	124			
613	SORGHUM POLLINATING BAG-SCINATION	124			
614	KRAFT PAPER BAG-SCINATION	124			

TABLE OF CONTENTS

(SEQUENTIAL ARRANGEMENT OF TITLES AS PER THEIR PAGE NUMBER)

PRISTINE BIOMEDICAL <i>THE BRAND APART, THE STRAND APART</i>		
SL NO	DESCRIPTION	PAGE NO
634	INTRON BIOTECHNOLOGY: MOLECULAR DIAGNOSIS - HIGH SPECIFICITY & SENSITIVITY	127
635	RAPID DIAGNOSIS - EASY TO USE FOR SCREENING	127
636	PRODUCTS FOR LIFE SCIENCE - FROM EXTRACTION TO THE DETECTION	127
637	INTRON BIOTECHNOLOGY: PREMADE BUFFER	133
638	INTRON BIOTECHNOLOGY: VIRUS & BACTERIA	138
639	CLINICAL CHEMISTRY: BIOCHEMISTRY / DIAGNOSTICS REAGENTS / KITS	143
640	ELISA KITS / RIA KITS	143
641	PLANT ANTIBODIES / DETECTION REAGENTS	162
642	LABORATORY REAGENTS, FINE CHEMICALS & FILTER PAPERS	197
643	MOLECULAR BIOLOGY/IMMUNOLOGY/TISSUE CULTURE WARE/ LABWARE	262
644	CUSTOM DNA SYNTHESIS (DESALTED DNA OLIGOS)	264
645	SEQUENCING SERVICES	264
646	FILTER PAPERS	265
647	MOLECULAR BIOLOGY KITS, REAGENTS SCIBIO-PRISTINE	266
648	CUSTOM SERVICES	273
649	NEXT GENERATION SEQUENCING	273
650	LONG READ SEQUENCING	286
651	SANGER SEQUENCING SERVICES	287
652	MICROARRAY AND GENOTYPING	288
653	PROTEOMICS & ANALYTICAL SERVICES	288
654	CUSTOM OLIGO SYNTHESIS	289
655	MOLECULAR BIOLOGY KITS	289
656	SAMPLE PREREQUISITE	289
657	ASSAY KITS FOR FOOD, FEED, DAIRY, WINE, BEVERAGE, CEREALS, FERMENTATION AND BIOFUEL	290
658	LIQUID HANDLING, CYTOGENETICS, ROBOTICS	305



General Laboratory Supplies
Cell Culture Labwares
Glasswares/Plasticwares
Agricultural field items
Syringe Filters/Filter Papers
Electrophoresis/Power supplies
Chemistry Lab, Engineering Labwares/
Instruments, Surgical Items
Rhizon Samplers/ Label Printers

2022

PRISTINE BIOMEDICAL

CB 201, Suite #6, Guru Harkishan Plaza
Industrial Area, Naraina Ring Road
New Delhi 110028

Ph: +91 965 427 3263, +91 888 278 0325
info@pristinebiomedical.com, pristbio@gmail.com
<https://www.pristinebiomedical.com>

Index 2021

Ordering & Processing

Ordering & Technical Support

For your convenience, you may place your order by the method that is best for you, order via email or mail or you can call our processing staff to your place to place an order in hand. Our highly efficient order processing center will process your order quickly and accurately.

Important Contacts:

Phone : +91 965 427 3263
+91 987 139 8048
E-Mail : pristbio@gmail.com
info@pristinebiomedical.com

Terms & Conditions

In order to serve you better, please ensure that your purchase order carries the following:

- Your complete address with Telephone/Fax Nos. and E-mail ID.
- Our catalog number, pack size, quantity and product description.

Price: The price mentioned in the catalog are FOR destination. All the items which requires special packing of cool pack (Dry ice packing), (All perishable items), Rs.1500/- shall be charged extra per consignment. However, prices are subject to change from time to time due to the unforeseen circumstances such as increase of custom duty, variation in foreign currency rates, any Govt. taxes imposed etc. which are beyond our control. Any variation made in quoted products, quantities, prices, terms or conditions those given in this catalog at the time of placing the order by you, shall not be binding on Pristine Biomedical unless agreed by us on writing.

Taxes: All sales tax and other Govt. levies such as octroi etc. shall be charged extra at the time of supply as applicable. Customers who have any sales tax concession must submit the necessary sales tax declaration form along with the confirmed order. In absence of such forms should be charged full as applicable.

- When you order, please include the following information:
- Institution or company customer number
- Billing address
- Shipping address
- Valid purchase order number
- Name of purchasing agent and department
- Name and phone number of end user
- Catalog number and description of product
- Quantity and size of product

Claims : All the consignment should be verified immediately on receipt of the same at your end and in case you found any discrepancy, please put forward the same to our notice within 4 days from the date of receipt of the material by you.

Payment : All payment are to be made in advance with purchase order.

Part Shipment: We try to make the products available in complete from our ex-stock, but yet, we may require 4-6 weeks to supply the ordered material. Hence, part supply may kindly be accepted.

Perishable Items: Delivery charges for all perishable items shall be extra Rs.1500/- per consignment. Freight will be charged extra as applicable.

All the prices, terms and conditions are subject to New Delhi jurisdiction only.

Lab Accessories

DOT LABELS & STRIPS

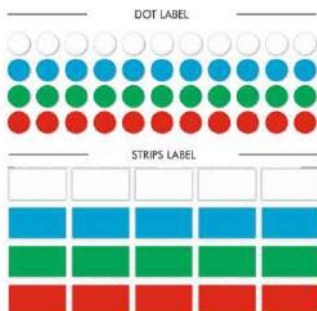

- Cost Effective
- Pre Cut, Peel Off
- 4 Colour Options
- Temperature Range -86°C to 121°C
- No Lamination Required
- Unique Adhesive Formulation
- Ideal for Ultra Low Temperature Applications
- Unique Adhesive Formulation
- Ideal for Ultra Low Temperature Applications
- Country of Origin: USA

Dot Labels & Strip Labels

Cat. No.	Description	HSN	GST%	Price
712-043	Dot Labels(Tough Spots),1/2 inches,1/pk, 1000pcs	39201099	18	3366
712-044	Dot Labels(Tough Spots),3/8 inches,1/pk, 1000pcs	39201099	18	3366
712-045	Dot Labels(Tough Spots),1/2 inches, 5-up Assorted Colours,1/pk,5000pcs	39201099	18	13106
712-046	Dot Labels(Tough Spots),3/8 inches, 5-up Assorted Colours,1/pk,5000pcs	39201099	18	13106
712-047	Strip Labels(Tough Tags), 1.28 inches x 0.50 inches,1/pk,1000pcs	39201099	18	4200
712-048	Strip Labels(Tough Tags),0.94 inches x 0.50 inches,1/pk,1000pcs	39201099	18	3586
712-049	Strip Labels(Tough Tags) Station,1/pk	39201099	18	10200

CONTAINER SEAL

- Container Seal is a sealing tape designed for the vast range of bottles and containers used in laboratory application.
- Its unique elastomeric characteristics allow it to stretch and conform around the irregular perimeters of containers lids and covers to form a tight seal.
- Container Seal will block water vapor loss, reduce the rate of gas exchange and prevent entry of contaminants.
- Ideally sized (0.75" wide) tape can be easily removed from surface without leaving an adhesive residue.
- Container Seal stretches and conforms, can resist chemical & temperature range and is waterproof.
- Available in a wide variety of colours.



Container Seal

Cat. No.	Description	HSN	GST%	Price
712-037	Container Seal,0.75inch x 108ft,Clear,1/pk	39201099	18	6577

CRYO-BABIES AND CRYO-TAGS

- Cryo-Babies are ideally used for 0.5ml and 2.0ml tubes and Cryo-Tags are used for general-purpose applications.
- Cryo-Babies and Cryo-Tags can withstand freezer temperatures down to -196°C (liquid and vapor phase nitrogen), boiling water baths (100°C), autoclaving and moderate oven temperature (150°C). They will resist water soaking for at least 24 hours at room temperature and water vapor (100% relative humidity) at 35°C for at least 24 hours.
- These are chemically inert labels and resist most organic solvents and caustic agents.
- Made with a flexible, polyolefin label material and acrylic adhesive. This unique combination expands and contract together with temperature fluctuations resulting in strong adhesive bond.
- These labels can adhere to most plastics (100% virgin polypropylene tubes recommended), glass and metals without cracking, peeling or degrading.
- These labels accept writing from most lab markers.



Cryo Babies & Cryo Tags

Cat. No.	Description	HSN	GST%	Price
712-040	Cryo- Babies , 0.94 inches x 0.50 inches,1/pk,1000pcs	39201099	18	3960
712-041	Cryo- Babies , 1.28 inches x 0.50 inches,1/pk,1000pcs	39201099	18	3960
712-042	Cryo- Tags , 1.50 inches x 0.75 inches,1/pk,1000pcs	39201099	18	3960

PETRI SEAL



- Petri-Seal stretches and conforms to form a tight seal and is temperature resistant, waterproof and chemically resistant.
- It resists abrasion and puncture and blocks vapor loss while reducing the rate of gas exchange.
- Petri-Seal can be used with microtiter plates, petri dishes and culture plates to prevent entry of any contaminants.
- Petri-Seal remains flexible down to -30°C and can withstand continuous exposure from -40°C (with intermittent exposure up to 100°C).
- Tests have shown that Petri Seal leaves on adhesive residue even after two years.
- Available in wide variety of colours.

Petri Seal

Cat. No.	Description	HSN	GST%	Price
712-050	Petri Seal , 0.5 inches x 108 feet , Clear,1/pk	39201099	18	5120
712-051	Petri Seal , 0.5 inches x 108 feet , White,1/pk	39201099	18	5120
712-052	Petri Seal , 0.5 inches x 108 feet , Blue,1/pk	39201099	18	5120
712-053	Petri Seal , 0.5 inches x 108 feet , Red ,1/pk	39201099	18	5120
712-054	Petri Seal , 0.5 inches x 108 feet , Yellow,1/pk	39201099	18	5120

DURA SEAL



- Dura-Seal the durable, heat and solvent- resistant stretch film, has substantial advantages over common laboratory stretch films.
- Its superior heat-resistant allows for containers to be incubated in boiling water baths without suffering the characteristic melting of paraffin based alternatives.
- Dura Seal based and free of any adhesives, it can resist essentially all caustic agents and organic solvents.

Dura Seal

Cat. No.	Description	HSN	GST%	Price
712-055	Dura - Seal , 2 inches x 500 feet,1/pk	39201099	18	5574
712-056	Dura - Seal , 4 inches x 250 feet,1/pk	39201099	18	5574

INDICATOR TAPE FOR STEM AUTOCLAVE

- Versatile tape indicates completion of normal steam sterilization process.
- Tape accepts and written notations, may be used to seal and identify almost all laboratory material before and after processing.
- Change in the color of the written matter from white to dark after completion of autoclave cycle.



Sizes vary, image for reference only.
See description for details.

Indicator Tape for Stem Autoclave

Cat. No.	Description	HSN	GST%	Price
712-064	Indicator Tape for Steam Autoclave, 1 inch x 500 inches, 1/pk	39201099	18	2620

HIGH TEMPERATURE INDICATOR TAPE



- High Temperature Indicator Tape shows the word "Sterilized" in bold letters after standard dry oven processing.
- These are imprinted with heat-sensitive indicator ink.
- These are cloth-textured tape that can stick to any surface or shape and can withstand acids, alkalis, oils and greases.

High Temperature Indicator Tape

Cat. No.	Description	HSN	GST%	Price
712-065	Hi Temperature Indicator Tape, 0.75 inches x 250 inches,1/pk	39201099	18	6960

SPILFYTER LAB SOAKERS

- Premium sorbent for extended-use/high durability.
- Designed specifically with the lab or cleanroom environment in mind.
- Encased in a low-lint, durable coverstock
- Use low-lint pads to keep work areas safe, free from spills, and from liquid or chemical over-run.
- Available in two sizes for multiple use applications.
- Contain spills and prevent migration.

Chemical and skid resistant backing absorbs spills and cushion delicate glassware. Used for lining hoods, animal cages, trays, drawers or shelves. Can be used



Spilfyter Lab Soakers					
CAT. NO.	DESCRIPTION	HSN	GST%	PACKING	PRICE/PACK
412-185	16" X 20" 250 pads pack Light Duty 750ml/Sq mtr	56039100		1	10851
412-186	20" X 400" 1 Roll pack Light Duty 750ml/Sq mtr	56039100		1	9703
412-187	16" X 20" 250 pads pack Heavy Duty 1050ml/Sq mtr	56039100		1	14183
412-188	20" X 400" 1 Roll pack Heavy Duty 1050ml/Sq mtr	56039100		1	8638

SAINT GOBIN BENCH PROTECTOR



- Inert to most chemicals
- Non-stick and easy to clean
- Easily cut and mounted
- Pressure-sensitive acrylic adhesive
- Use to resurface bench tops and line fume hoods

The bench protector is a laminate consisting of FEP film that is bonded to a support backing of either vinyl or aluminum. The backing is coated with a pressure-sensitive, acrylic adhesive. The Bench protector adheres to most surfaces and conforms to minor irregularities.

The Bench protector provides an easy and economical way to protect bench tops, fume hood surfaces, tables, walls/ceilings, splash screens, and other surfaces with non-stick, chemical-resistant film. Corrosive chemicals, paint, oil, grease, and sticky foods are easily removed by wiping with a damp sponge. Bytac® can be used to protect surfaces from adsorption of radioactive chemicals. It is also useful to contrast surfaces for better observation. Removal of Bytac® is a simple peel-off process that leaves no sticky residue.

Applications:

- Rejuvenate old benches

- Expand work surfaces
- Line fume hoods to protect against damage from corrosives
- Line the apron (ledge) at the front of the fume hood
- Create a non-absorbent, contamination-free surface that can be washed with chlorine bleach for clinical and biological labs
- Make a splash screen behind the sink or work area for easy cleanups
- Bytac Is A Laminate Consisting Of Fep Film That Is Bonded To Vinyl Backing.
- Bytac Provides An Easy And Economical Way To Protect Bench Tops, Fume Hood Surfaces With A Non-Stick Chemical Resistant fluoropolymer Film.
- It Creates A Non-Absorbent, Contamination Free Surface That Can Be Washed With Chlorine Bleach For Clinical And Biological Labs.
- Corrosive Chemicals Or Sticky Substances Are Easily Removed By Wiping With A Damp Sponge.

Saint Gobin Bench Protector

Cat. No>	Description	HSN	GST%	PACKING	Price/Pack
412-181	32 X 460 cm pack of 1				34311
412-182	63.5 X 460 cm pack of 1				44311

SAINT GOBIN CHEMWARE BOILING STONES



Boiling stones of PTFE promotes efficient boiling preventing superheating and minimizing bumping during reflux and speed distillation. Stones will not scratch or abrade glassware. Used upto 288°C.

Saint Gobin Chemware Boiling Stones

Cat. No	Description	HSN	GST%	PACKING	Price
412-180	Boiling Stones 1lbs			1	4177

HIGH-LOW TEMPRATURE INDICATOR TAPE

- Cloth-textured tape that can stick to any container, withstands acid, alkalis, oil, greases, dry ice and liquid gases and wont crack or peel in dry oven or cryogenic temperatures.



High-Low Temperature Indicator Tape

Cat. No.	Description	HSN	GST%	Price
712-066	High-Low temperature indicator Tape, 1 inch ,1/pk	39201099	18	6480

LABORATORY MARKERS



- These Markers are waterproof on most surfaces.
- Light Fast
 - Can be left uncapped for days without drying out.
 - Can be staked easily on the workstation.
 - Note : Mention colour while ordering

Laboratory Markers

Cat. No.	Description	HSN	GST%	Price
712-057	Markers,Red,Blue,Green Black 1pc/pk	96083019	12	1602

LABORATORY LABELLING TAPE



Adhere to almost any dry surface-glass, plastic, metal, paper and rubber.

Oil- proof, waterproof and acid resistant and can be steam autoclaved.

Holds in a wide range of temperatures and transfers cleanly from one surface to another, leaving no messy residue.

These labels accept handwritten notations inscribed with pen, pencil or marker.



Laboratory Id Tape (Write-on-Lable Tape)

Cat. No.	Description	HSN	GST%	Price
712-058	0.75 inches x 500 inches, White,1/pk	39201099	18	994
712-059	0.75 inches x 500 inches, Blue,1/pk	39201099	18	994
712-060	0.75 inches x 500 inches , Green,1/pk	39201099	18	994
712-061	0.75 inches x 500 inches , Orange,1/pk	39201099	18	994
712-062	0.75 inches x 500 inches , Yellow,1/pk	39201099	18	994
712-063	Laboratory Tape Dispenser , 500 inches Roll,1/pk	73262090	18	10200

BIOHAZARD BAGS



*Mainly used for Disposal of Biohazard waste and can be used for autoclaving objects in a safe and efficient way. *Ideal for autoclaving animal cages, petri dishes, membrane filters, culture plates, pipettes, etc.

*Color: Red/Yellow/Clear

*Country of Origin: INDIA/EU



Biohazard Disposable Bags

Cat. No.	Description	HSN	GST%	Price
712-002	Biohazard Disposable Bags, PP, 12 x 18 inch,200/pk	39232100	18	3095
712-003	Biohazard Disposable Bags, PP, 12 x 24 inch,200/pk	39232100	18	3444
712-004	Biohazard Disposable Bags, PP, 18 x 22 inch,200/pk	39232100	18	3939
712-005	Biohazard Disposable Bags, PP, 25 x 35 inch,200/pk	39232100	18	7402

AUTOCLAVABLE BAGS

- polypropylene autoclavable bags made of 100 micron thickness
- Used for discarding used petri dishes, membrane filters, cell culture flasks, pipettes, culture plates and other plastic products.
- Transparent.
- Can be autoclaved



Autoclavable Bags				
Cat. No.	Description	HSN	GST%	Price
712-006	Autoclavable Bags, PP , 8 x 12 inch,100/pk	39232100	18	1836
712-007	Autoclavable Bags, PP , 12 x 24 inch,100/pk	39232100	18	2397
712-008	Autoclavable Bags, PP , 16 x 18 inch,100/pk	39232100	18	2630
712-009	Autoclavable Bags, PP , 16 x 24 inch,100/pk	39232100	18	4202

RESEALABLE BAGS WITH ZIP LOCK



- used to store and ship samples, solids and food.
- Suitable for use with food.
- Though it can be used for all applications it has especially used in food, water, forensic science and quality control laboratory.
- Using the rim and channel closure the bag can be closed by finger pressure and reopened repeatedly.
- Content stored in the bag would be dust free and free of contaminants.

Resealable Bag with Zip Lock				
Cat. No.	Description	HSN	GST%	Price
712-010	Resealable Bags with Zip Lock,PE,10.2x9.8 inch,100/pk	39232100	18	1012
712-011	Resealable Bags with Zip Lock,PE,13.35x13 inch,100/pk	39232100	18	1890

SAFETY GOGGLES

- Ultra Clear
- Polycarbonate lens with side shield.
- Impact resistant and lightweight frames for comfortable eyewear.
- 99.9% UVA/UVB protection.
- Lightweight



Safety Goggles				
Cat. No.	Description	HSN	GST%	Price
712-012	Safety Goggles,2/pk	90049090	18	1350

SAFETY GOGGLES BOX

- Safety Goggle box can be set as Benchtop box or wall mounted for storage of goggles, glasses and other small lab products.
- Safety Lid Keeps the box free of dust and contamination.
- Clear window helps to view the inventory from the outside.

Safety Goggles Box				
Cat. No.	Description	HSN	GST%	Price
712-013	Safety Goggles Box, Acrylic,23 x 16 x 18 mm,Small,1/pk	39269099	18	3840
712-014	Safety Goggles Box, Acrylic,23x16x25 mm,Large,1/pk	39269099	18	4800

SAFETY FACE SHIELD

- Polycarbonate, provides high impact and splash protection.
- Ratchet adjustment on the headgear for comfortable fit.

Safety Face Shield

Cat. No.	Description	HSN	GST%	Price
712-015	Safety Face Shield, 15.5x8x0.04 inch, 1/pk	90049090	18	6259



PARTICULATE RESPIRATOR



- Polycarbonate, provides high impact and splash protection. Compatible with a variety of protective eyewear and hearing protection.
- Adjustable nose clip reduces potential for eyewear fogging and helps ensure a better seal and fit.
- Two-strap design with welded dual point attachment helps provide a secure fit.
- Suggested applications: Grinding, sanding, sweeping, bagging and other dusty operations.
- NIOSH/MSHA approved.

Particulate Respirator

Cat. No.	Description	HSN	GST%	Price
712-016	N 95 Mask, N 95 Particulate respirator, Regular 20/pk	63079090	12	2000
712-017	N 95 Particulate respirator with exhalation, Regular 20/pk	63079090	12	3200

TEMPERATURE RESISTANT GLOVES



Non-Slip grip
Free Size.
Fits All
Flexible & Durable
Chemical Resistant
Temperatures Range -57 °C to +250 °C
Formulated from special grade silicone rubber which provides

superior protection when handling hot or cold objects like flasks, beakers etc. Available in two formats i.e. Grips & Gloves.



Temperature Resistant Gloves

Cat. No.	Description	HSN	GST%	Packing	Price
712-636	Temperature Resistant Hand Grip	40159030		4pcs/pk	3500
712-637	Temperature Resistant Hand Glove	40159030		2prs/pk	4000

CRYO GLOVES



Tempshield Cryo-Gloves, Mid-Arm Length - Medium (size 9) (605-M)

Tempshield cryogloves offer protection for people withdrawing or dispensing liquid nitrogen from a storage Dewar.

These gloves have been developed specially for the handling of very cold objects. At liquid nitrogen temperatures, there is some stiffening of the material, but it still remains flexible enough for use.



Cryo-Glove Liquid nitrogen gloves should not be immersed in the liquid nitrogen

CRYO Gloves					
Cat. No.	Description	HSN	GST%	Packing	Price
712-638	Cryo Gloves, Wrist, Medium	4015 1990		1	12967
712-639	Cryo Gloves, Wrist, Large	4015 1990		1	12967
712-640	Cryo Gloves, Mid Arm, Medium	4015 1990		1	14950
712-641	Cryo Gloves, Mid Arm, Large	4015 1990		1	14950
712-642	Cryo Gloves, Elbow	4015 1990		1	18850
712-643	Cryo Apron, 42"	4015 1990		1	18850
712-644	Cryo Apron, 48"	4015 1990		1	20150

FOOT PROTECTION

AUTOCLAVABLE CLEANROOM SHOES

- Material - Heat resistant rubber.
- Use - For Usage in Sterile Room, Clean Room environment & Operation Theatre.
- Fastener - Heatproof adjuster.
- Colour - White
- Fully covered from all side
- Rubber
- Heel measures approximately 1.5 inches"
- Latex free available and antistatic
- 1.5" heel to reduce fatigue
- Slip resistant sole, medium width
- Sterilize in the autoclave, machine washable or disinfect with bleach



Disposable Polypropylene Shoe Covers, L, 100-Pack Blue

Disposable polypropylene
Economical and disposable
Made of polypropylene non-woven fabric
100-count, 50-pairs of blue shoe covers
Fit shoes up to size 10

Safety Gumboot, Black

- Sizes: 5 to 10, 39 to 44
- Height: 12.5 inch
- Inside Lining: Fabric
- Dual Density: Soft upper and harder sole
- USP: Sturdy design best in category



Foot Protection					
Cat. No	Description	HSN	GST%	PACKING	Price/Pack
500-529	Autoclavable shoe 1 pair			1	2884
500-534	Shoe Cover Disposable PP 100pc/pouch,10pouch/cs			1	6660
500-535	Shoe Cover Disposable NW 100pc/pouch,10pouch/cs			1	7480
500-529A	Safety Gumboot, Black, 1pair X 10			1	6042

FACE MASK



Features: Soft, Good Breathability, Clean, Hygienic, Environmentally Friendly
Color: Blue, Green, White, Pink and Customized.
Standard Size: Adults:17.5 cm x 9.5 cm.; Kids :14.5cm x 9cm.
Loop: Soft round Latex Free elastic.
Fabric: 100% Non-woven + Melt blown fabric
String Length: (Ribbon): 36" and weight of String: 30 gsm x 20mm. **Packing:** 100 pcs
BFE & PFE >98%: Higher Bacteria Filtration Efficiency of >98% @ 3.0 microns and Higher Particulate Filtration Efficiency of >98% @ 0.1 micron against bacteria and viruses.
Free-Size & Comfort: Spandex Elastic ear loops, comfortable for long wearing, built-in metal adjustable nose pin provides a perfect fit, easy to breathe through.
Fluid Resistant, Anti-Pollution & Anti-Dust: protection against bodily fluid and spatter at high resistance. protection against dust and air pollutants.
3 Layer Non-Woven Fabric: Hydrophobic, Electrostatic Charged

Melt Blown, Hydrophilic.

100% Made in India: manufactured in state-of-the-art ISO certified GMP facility.

FACE MASK					
Cat. No	Description	HSN	GST%	PACKING	Price/Pack
500-531	Face mask 3ply Disposable 100Pcs/bx, 20bx/cs	90192090		1	11500
500-533	Dust mask 50Pc/pk	90192090		1	1972
211-557	N95 surgical mask,35x6 pk/Cs	90192090		1	45000
211-557A	KN95 surgical mask,10Pcs	90192090		1	315

HEAD COVER

Standard Size : 16", 18",21"

Features : Soft, Good Breathability, Clean, Hygenic, Enviromental Friendly, Cap is compacted in a Strip and can be easily open to wear/shape.

Color : Blue Green White Pink and Customized.

Weight (gsm) : 10,12,14 gsm.

Material : P.P Spun bond , Spun lace, SMS.

Application : Used in Hospitals ,Pharmaceuticals Ind., Food Industries, Electronic Industries, and other industries, Saloons etc.

Packing : 100 pcs



HEAD COVER					
Cat. No.	Description	HSN	GST%	PACKING	Price/Pack
500-536	Head Cover, Disposable Liner, 100Pc/Pouch, 10Pouch/Cs	90189099		1	6220
500-537	Head Cover, Disposable circular, 100Pc/Pouch, 10Pouch/Cs	90189099		1	7220
500-538	Beard Covers 100Pc/Pouch, 10pouch/cs	90189099		1	7130

LABCOAT DISPOSABLE

Features : Soft ,Good Breathability, Clean, Hygenic, Enviromental Friendly

Color : Blue Green White and Customized.

Weight(gsm) : 25-50 gsm.



Size : S,M,L,XL.

Material : P.P Spun bond , Spun lace, SMS, non woven plastic coated/Customized.

Application : Used in Hospitals, Pharmaceuticals Ind., Food Industries ,Electronic Industries, and other industries, Saloons etc.

Packing : 10 pcs

LABCOAT DISPOSABLE					
Cat. No>	Description	HSN	GST%	PACKING	Price/Pack
500-526	Beta Apron 32" X 20", 1pk	62011390		1	18623
500-527	Chemical Apron 1Pc/Case	62011390		1	18623
500-540	LabCoat front five snap closer, low lint, breathable 25/Cs	62011390		1	5492
500-540A	LabCoat, Cotton, Washable	62113200		1	1587
500-541	LabCoat (Laminated) front four snap closer, splash resistant,25/Cs	62011390		1	5646
500-540B	PPE Kit Laminated 85 GSM 10pcs/pk	6307		1	3200
500-540C	PPE Kit 70 GSM 10pcs/pk	6307		1	2000
500-542	LabGown Lint Free, Back tie closer, splash resistant, breathable 25/Cs	62011390		1	5800
500-542A	Disposable Apron Blue/White Sterile 100pcs			1	1800
500-542B	Full Sleeve Made of 100% Cotton 40, 42, 44			1	950

DISPONSABLE COVERALLS

DISPOSABLE COVERALLS BLUE/WHITE X LARGE 48-50" CHEST 31" L

Breathable fabric with full-length front zip and elasticated hood and ankles.



Knitted Cuffs for Comfort
 2-Way Front Zip
 Reinforced Gusset
 Protection Against Chemical Handling
 Clothing Size Description : XL
 Colour : Blue
 Construction Material (Safety) : 100% Polypropylene
 Gender : Unisex
 Leg Length (Inches) : 31"
 Pack Size : 1
 Product Type: Disposable Coveralls
 Serged seams, attached hood, front zipper closure, elastic wrists and attached boots(Optional)
 Inherent barrier protection against dry particulate hazards
 Applications range from agriculture to spray painting to lead remediation
 Even after abrasions, stops microporous particles better than other reusable garments



The best balance of protection, durability and comfort

Disposable Coverallas					
Cat. No>	Description	HSN	GST%	PACKING	Price/Pack
211-517	XP Large 25Bags/Cs	62114300		1	26775
211-518	Kleenguard XP Medium 25Bags/Cs	62114300		1	26775
211-512	Kleenguard A10 25Bags/Cs	62114300		1	26775

KIMTECH WIPERS

- Kimtech Science KimWipes Delicate Task Wipers; 4.4 x 8.4 in. (11.2 x 21.3cm); 1-ply 280 count
- Low lint and low extractables
- Absorbs 18% more water than other private label wipers
- Absorbs water 24% faster than other private label wipers
- One-at-a-time dispensing
- Won't scratch delicate surfaces when wet



Kimwipe Wipers					
Cat. No.	Description	HSN	GST%	Price	
712-018	Kimtech Science Kimwipes Wipers,11.17 x 21.3 cm,280 sheets,60/pk	48182000	18	18900	
712-019	Kimtech Science Kimwipes Wipers,37.33 x 42.16 cm,140 sheets,15/pk	48182000	18	17880	

KIMTECH WIPERS

- **WYPALL* X70 Wipers / Roll / Blue/white**



- Tackle the toughest tasks with strong, reusable WYPALL* X Cloths.
- Absorbent wipers, help improve efficiency and reduce costs.
- Ideal product to replace cloth towels or rags.
- Can exceptionally absorb oil, grease, solvents and water.
- Designed to perform the wiping function that helps to improve productivity and performance.
- Made from advanced HYDROKNIT material that deliver products that are absorbent, higher in strength and have more bulk.
- Bio-degradable hence reduce disposable cost and are environmental friendly.
- Available in 100 meters roll format in white and blue colour with perforation making it easy to use.

- **WYPALL* L40 Wipers -**

- **Large Roll / Blue**

- Keep efficiency in mind, get the job done quicker and keep hygiene levels high with our range of great-value wiping solutions.
- When you need an absorbent, Limited Life Wiper for a variety of tasks, the WYPALL* L range has a solution to meet your needs.
- WYPALL* L40 Wipers can be used for cleaning large spills and machinery components, yet are soft enough for the face or hands.
- This product will consistently deliver the wiping performance that you need in convenient and cost effective manner.
- Wiper is highly absorbent, thus controls usage and reduces wastage.
- One time use and throw wipers, eliminates cross-contamination.
- Wipers have low lint hence do not leave particles behind.
- Versatile, highly absorbent wiper leaves surface clean and dry.
- Available in both sheet and roll format that makes it easy to use.



Wypall Wipers

Cat. No.	Description	HSN	GST%	Price
712-023	Wypall X70 Wipers , 24.7 x 20 cm , White,100mtrs/roll	48181000	18	3707
712-024	Wypall X70 Wipers , 24.7 x 20 cm , Blue,100mtrs/roll	48181000	18	3707
712-025	Wypall X70 Wipers , 26 x 26 cm , White,50sheets	48181000	18	700
712-026	Wypall X70 Wipers , 25.4 x 38.1 cm , Blue,50 sheets	48181000	18	893
712-027	Wypall L 40 Wipers , 21.75 x 36.5cm,White,56 sheets	48181000	18	642
712-028	Wypall L 40 Wipers , 38 x 23.4cm , Blue,300mtrs/roll	48181000	18	5490
712-028A	General Purpose Tissue Roll 42 x 17.4 x 9.5cms 96rolls	48181000	18	5760
712-028C	General Purpose Tissue Roll 18 x 18 x 20 cms 80rolls	48181000	18	7360

GLOVE BOX HOLDER

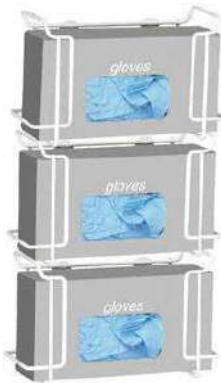

- **Glove Box Holder Acrylic**
- Designed to be installed at any place (wall or benchtop), Can easily be wall mounted.
- A designated place for gloves.
- Clear and pristine holder to give clean appearance.
- Top loading.
- Easy to dispense through the holder.
- Easy to be installed in a convenient location to the proximity of your work and tasks.

Glove Box Holder

Cat. No.	Description	HSN	GST%	Price
712-020	Glove Box Holder, Acrylic , 260 x 100 x 138 mm	39269099	18	1980
712-021	Glove Box Holder, Acrylic , 260 x 100 x 270 mm	39269099	18	2628
712-022	Glove Box Holder, Acrylic ,260 x 100 x 415 mm	39269099	18	3480

KIMCARE NTO HAND CLEANER/ HAND SANITIZER

- **3M Avagard CHG HANDRUB**
- Contains: Chlorhexidine Gluconate 0.5% w/v and Ethyl Alcohol IP 70% v/v, moisturizers and emollients
- Provides broad-spectrum antimicrobial activity
- Applied in a fraction of time causing rapid skin disinfection
- High persistent effect providing protection for longer duration
- High quality moisturizers to prevent skin dryness
- Unique dispensing mechanism.
- CHG+Ethanol based hand antiseptic for rapid kill and persistent action



Kimcare NTO Hand Cleaner/ Hand Sanitizer

Cat. No.	Description	HSN	GST%	Price
712-029	Kimcare NTO Hand Cleaner,200 ml,10pcs	34013090	18	4000
712-030	Kimcare NTO Hand Cleaner,3500 ml ,1/pk	34013090	18	4500
712-029A	Pristine Hand Sanitizer,500 ml 20/pk	34013090	18	9000

PARAFILM M



Parafilm® M is a unique self-sealing, moldable and flexible film for numerous uses in the typical laboratory including electron microscope laboratories. Parafilm® M has unique permeability properties, impressive water vapor transport properties, and is resistant to many common reagents. With the use of the special Parafilm® M dispenser, which is sized to take either the 2" (50.8 mm) or 4" (101.6 mm) wide rolls, one can conveniently cut off uniform sized strips or squares of 2" (50.8 mm) length. The thickness of all Parafilm products is 0.005" (127µm).

Parafilm M				
Cat. No.	Description	HSN	GST%	Price
712-031	Parafilm M , 2 Inches x 250 feet, 1/pk	39219099	18	3060
712-032	Parafilm M , 4 Inches x 125 feet,1/pk	39219099	18	2760
712-033	Parafilm M , 20 Inches x 50 feet,1/pk	39219099	18	6480

PARAFILM DISPENSER

Acrylic Parafilm Dispenser : (25.4 mm) and 4" (100.8 mm) wide rolls fast , safe, and easy, make possible with the smooth downward lever action. The recessed blade ensures safe, dependable use and simplified replacement. The automatic lever holds the desired cut-off length in place adding stability while dispensing.



The ABS Parafilm Dispenser features a unique design that provides maximum user safety. This product can store, dispense, and cut Parafilm, tape, labels, and Tough-Tags. The dispenser has a safety razor that slides and cuts with no danger to your fingers. It is able to store one or two 2-inch rolls, or one 4-inch roll. (Manufacturer: Andwin Scientific 7099301)

Parafilm M Dispenser				
Cat. No.	Description	HSN	GST%	Price
712-034	Parafilm M Dispenser, Acrylic , 2 & 4 inch,1/pk	39269099	18	3084
712-035	Parafilm M Dispenser, ABS , 2 & 4 inch,1/pk	39269099	18	3794

Workspace Storage Bins

Ergonomically designed benchtop storage bins to work with gloved hands
 Large, angled openings and oversized lip.
 Lid remains open when tilted back
 Can be wall mounted



Parafilm M Dispenser				
Cat. No.	Description	HSN	GST%	Price
712-034A	BENCHTOP Storage Top, Acrylic 9' approx..	39269099	18	3084

FREEZER THERMOMETER

- Can be used as probe to investigate and protect frozen and chilled samples from potential spoilage.
- Monitor temperature inside your freezer or refrigerator with the added convenience of sound and flashing LED lights to alert out-of-range temperatures.
- Suction cup attaches the probe inside freezer/refrigerator while the thermometer secures to the outside with hook-and loop tape.
- Large digital display shows freezer / refrigerator temperature plus ambient temperature.
- Set freezer range: (-9.5° to -23° C); set refrigerator range: (2° to 8° C)
- Can be used as Fahrenheit °F or Celsius °C
- Includes one AAA battery.
- Probe cable measures 0.9 m; probe measures 5 mm OD x 17 mm L.



Freezer Thermometer

Cat. No.	Description	HSN	GST%	Price
712-036	Freezer Thermometer , 136 x 19 x 28 mm,1/pk	90251980	18	3960

LABORATORY BURNERS



Lenk's Model 65 Laboratory Burner is small, compact and portable. It eliminates the need for external fuel tanks, costly piping or unsightly hoses. Being self-contained, it is easily moved to any location and conveniently stored in a small space. The Model 65 delivers temperature up to 3000 °F for up to 7-9 hours from a single disposable fuel container.

- Ideal for applications requiring a hot flame
- Scientific Research, Industrial, and Institutional Laboratories hospital and Medical Offices, Clinics and Labs
- University and High School Laboratories

- Industrial and Fine Arts Departments
- Artisan's Studios, Sculpting, and Glass Blowing

Laboratory Burners					
Cat. No	Description	HSN	GST%	PACKING	Price/Pack
PB-BB-65	Butane Lab Burners complete set			1	9075
PB-65BH	Burner Head Up to 1/2" x 6" Flame			1	4075
PB-65F	Butane Fuel Net Weight 5.5 Ounces			1	4075
PB-65FS	Flame Spreader For a Flame up to 2"			1	3075

BETA RADIATION WIZARD

Beta shield is made of thick acrylic having thickness 10mm. BRS is designed to handle β -emitting isotopes. Sturdy Angled Design with High transparency allows clear view of the Samples located behind the shield.
Country of Origin: USA/INDIA

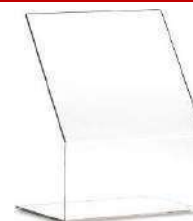

BETA RADIATION SHIELD					
Cat. No.	Capacity (ml)	HSN	Packing	GST%	Price
712-534	Beta Radiation Shield 45x30x30cm	39269099	1	18%	6750

BIOHAZARD WASTE CONTAINER



Lid Lock Design
Large Biohazard Warning Symbol
Suitable for Disposal of sharps

BIOHAZARD WASTE CONTAINER					
Cat. No.	Capacity (L)	HSN	GST%	Packing	Price/Pack
712-137	5L	39231090		1	1563
712-138	15L	39231090		1	1875

SAMPLE BAGS

Laboratory Sample Zip lock bags are made from low density polyethylene material. These high strength bags can be used for Storage and transportation of samples. These bags are ideal choice for small lab samples, food or botanical samples etc.
Size Available: 6"x8" / 8.5"x12.5" / 10.5"x14"



SAMPLE BAGS					
Cat. No.	Capacity	HSN	GST%	Packing	Price
MCZLB01	Size 6"x8"	3923 2100		100	450
MCZLB02	Size 8.5 x12.5"	3923 2100		100	750
MCZLB03	Size 10.5" x14"	3923 2100		100	1200

STAINLESS STEEL FREEZER STORAGE RACKS

VERTICAL / UPRIGHT FRAME TYPE / UPRIGHT DRAWER TYPE



- Made resistant
- Easy to by

your
- space

For use with mainly all standard upright

from Corrosion-stainless steel track samples improving organization in freezers Eliminate dead
- Compatible

and chest freezers

- Customize Size Available

Stainless Steel Freezer Racks						
Cat No.	Type	HSN	GST%	PACKING	Price/pack	
712-108	Vertical type for Cryo Box 2 Inch 4/pk	7326 9090		1	2750	
712-109	Vertical type for Cryo Box 2 Inch 5/pk	7326 9090		1	3375	
712-110	Vertical type for Cryo Box 2 Inch 7/pk	7326 9090		1	4688	
712-111	Vertical type for Cryo Box 2 Inch 9/pk	7326 9090		1	6063	
712-112	Vertical type for Cryo Box 2 Inch 10/pk	7326 9090		1	6750	
712-113	Vertical type for Cryo Box 2 Inch 12/pk	7326 9090		1	8000	
712-114	Vertical type for Cell Culture Plates 25/pk	7326 9090		1	5625	
712-115	Upright Frame type for Cryo Box 2 Inch	7326 9090		3x3	6188	
712-116	Upright Frame type for Cryo Box 2 Inch	7326 9090		3x4	8125	
712-117	Upright Frame type for Cryo Box 2 Inch	7326 9090		3x5	7813	
712-118	Upright Frame type for Cryo Box 2 Inch	7326 9090		4x3	8125	
712-119	Upright Frame type for Cryo Box 2 Inch	7326 9090		4x4	10875	
712-120	Upright Frame type for Cryo Box 2 Inch	7326 9090		4x5	11563	
712-121	Upright Drawer Type for Cryo Box 2 Inch	7326 9090		3x3	8625	
712-122	Upright Drawer Type for Cryo Box 2 Inch	7326 9090		3x4	8625	
712-123	Upright Drawer Type for Cryo Box 2 Inch	7326 9090		3x5	12500	
712-124	Upright Drawer Type for Cryo Box 2 Inch	7326 9090		4x3	11125	
712-125	Upright Drawer Type for Cryo Box 2 Inch	7326 9090		4x4	15000	
712-126	Upright Drawer Type for Cryo Box 2 Inch	7326 9090		4x5	18125	

FUNNEL

Available in 3 Size
-62mm / 75mm / 100mm



FUNNEL					
Cat. No.	Capacity	HSN	GST%	Packing	Price
MCFNL62	62mm	3926 9099		36	414
MCFNL75	75mm	3926 9099		36	432
MCFNL100	100mm	3926 9099		18	396

REAGENT RESERVOIR



Reagent Reservoir is ideal for liquid transfer while handling Multi channel pipettors.
Light weight
Capacity 50ml
Chemical Resistant
Sterile Available

REAGENT RESERVOIR

Cat. No.	Capacity	HSN	GST%	Packing	Price/Pack
712-219	Reagent Reservoir	39233090		50	3000
712-220	Reagent Reservoir Gamma Sterile, 5/pkg	39233090		50	3750

HEAVY DUTY ASPIRATORS

Heavy Duty & Stable
Autoclavable
High Quality Virgin Polypropylene
Leak Proof & break-resistant
Bold & Accurate Moulded Graduations
Ideal for long-term storage of liquids
Resistant to most acids & commonly used solvents



Volumetric Flask Glass Class A

Cat. No.	Capacity	HSN	GST%	Packing	Price
712-592	5 Ltrs	39233090		1	1900
712-593	10 Ltrs	39233090		1	3190
712-594	20 Ltrs	39233090		1	4500

MEASURING CYLINDER



Hexagonal Base gives Stable Design
Autoclavable
High Quality Virgin Polypropylene FDA Approved
Leak Proof & break-resistant
Bold & Accurate Moulded Graduations
Resistant to most acids & commonly used solvents

MEASURING CYLINDER Class B

Cat. No.	Description	HSN	GST%	Packing	Price
712-575	50ML	39269099		12	2640
712-576	100ML	39269099		6	1680
712-577	250ML	39269099		6	2760
712-578	500ML	39269099		6	3540
712-579	1000ML	39269099		4	3080
712-580	2000ML	39269099		4	7200
712-581	Assorted Kit	39269099		1	2510

* Assorted Kit Pack Contains following Cylinders
 50ml X 2 Pcs., 100ml X 2 Pcs., 250ml X 2 Pcs., 500ml X 1 Pcs.

PTFE Beaker (Teflon Cups)



- Non-contaminating and inert to highly corrosive reagents.
- Non-wettable, lightweight, and heat resistant up to 280°C
 - Machined base for good heat transfer
 - Easy to clean
 - Molded-in spout for easy pouring
 - Isostatically molded from pure PTFE

PTFE BEAKERS WITH SPOUT

Cat. No.	Description	HSN	GST%	Price
812-359	PTFE BEAKERS WITH SPOUT 50ML	39269099	18	1,060
812-360	PTFE BEAKERS WITH SPOUT 100ML	39269099	18	1,800
812-361	PTFE BEAKERS WITH SPOUT 250ML	39269099	18	3,450
812-362	PTFE BEAKERS WITH SPOUT 500ML	39269099	18	5,250
812-363	PTFE BEAKERS WITH SPOUT 1000ML	39269099	18	8,350

ARA HARVEST BASE WELLS

Unique Plastic Heavy Duty Root Trainer with Stand

- Material: Plastic, Color: Black
- Item Dimension: 35 cm x 23 cm x 16 cm or more
- Package Contents: 1-Piece Heavy Duty Root Trainer
- Cells Dimension: Upper diameter is 4cm, lower diameter is 2.5cm, height is 9.5cm, Vol is 110cc
- The trays are heavy duty and are reusable and last for many years
- Especially good for bedding plants, salads and herbs, but will work with all seeds, seedlings and cuttings
- A must-have for seeds, seedlings and cuttings
- Produce deeper, faster, straighter fibrous roots through air-pruning resulting in superior plants with no root disturbance or worry of pot bound



ARA HARVEST BASE WELLS ROOT TRAINER

Cat. No.	Description	HSN	GST%	Price
812-364	ARA HARVEST BASE WELLS 40CELLS	39239090	18	150
812-365	ARA HARVEST BASE WELLS 20CELLS	39239090	18	125
812-366	ARA HARVEST BASE WELLS 25CELLS	39239090	18	125
812-367	ARA HARVEST BASE WELLS 12CELLS	39239090	18	125
812-368	ARA HARVEST BASE WELLS 12 CELLS	39239090	18	125

VOLUMETRIC FLASK GLASS CLASS-A



Hexagonal Base gives Stable Design
Autoclavable
High Quality Virgin Polypropylene FDA Approved
Leak Proof & break-resistant
Bold & Accurate Moulded Graduations
Resistant to most acids & commonly used solvents

Volumetric Flask Glass Class A

Cat. No.	Capacity	HSN	GST%	Packing	Price
712-582	5ML	70179090		10	5985
712-583	10ML	70179090		10	5985
712-584	20ML	70179090		10	7485
712-585	25ML	70179090		10	7485
712-586	50ML	70179090		10	7485
712-587	100ML	70179090		10	8235
712-588	200ML	70179090		10	8985
712-589	250ML	70179090		10	11235
712-590	500ML	70179090		10	11985
712-591	1000ML	70179090		10	20985

REAGENT BOTTLE (NARROW MOUTH)

Narrow Mouth
Autoclavable
High Quality Virgin Polypropylene
Leak Proof & break-resistant
Ideal for long-term storage of liquids
Bold & Accurate Moulded Graduations
Resistant to most acids & commonly used solvents
*Amber Colour Available



REAGENT BOTTLE (NARROW MOUTH)

Cat. No.	Capacity	HSN	GST %	Packing	Price/Pack
712-547	30ml	39233090		12	504
712-548	60ml	39233090		12	600
712-549	125ml	39233090		12	828
712-550	250ml	39233090		12	1404
712-551	500ml	39233090		6	900
712-552	1000ml	39233090		6	1890

REAGENT BOTTLE (NARROW MOUTH), STERILE

712-553	30ml, Sterile	39233090		72	2970
712-554	60ml, Sterile	39233090		72	3668
712-555	125ml, Sterile	39233090		72	5340
712-556	250ml, Sterile	39233090		72	9270
712-557	500ml, Sterile	39233090		36	6750
712-558	1000ml, Sterile	39233090		36	13950

REAGENT BOTTLE (WIDE MOUTH)



Wide Mouth
Autoclavable
High Quality Virgin Polypropylene
Leak Proof & break-resistant
Ideal for long-term storage of liquids
Bold & Accurate Moulded Graduations
Resistant to most acids & commonly used solvents
Amber Colour Available

REAGENT BOTTLE (WIDE MOUTH)

Cat. No.	Capacity	HSN	GST %	Packing	Price/Pack
712-535	30ml	39233090		12	400
712-536	60ml	39233090		12	470
712-537	125ml	39233090		12	670
712-538	250ml	39233090		12	1020
712-539	500ml	39233090		6	710
712-540	1000ml	39233090		6	1460

REAGENT BOTTLE (WIDE MOUTH), STERILE

712-541	30ml, Sterile	39233090		72	2760
712-542	60ml, Sterile	39233090		72	3354
712-543	125ml, Sterile	39233090		72	4980
712-544	250ml, Sterile	39233090		72	7920
712-545	500ml, Sterile	39233090		36	6060
712-546	1000ml, Sterile	39233090		36	12360

REAGENT BOTTLES GLASS

Autoclavable
Chemical resistant
Amber Colour Available
Wide mouth for efficient handling
Unique Design Ensures High stability
Made From High Quality Borosilicate Glass



REAGENT BOTTLES Glass

Cat. No.	Description	HSN	GST%	Packing	Price
712-225	Reagent Bottle Glass 100ml	7017 9090		12	3688
712-226	Reagent Bottle Glass 250ml	7017 9090		12	3875
712-227	Reagent Bottle Glass 500ml	7017 9090		6	2063

REAGENT BOTTLES Glass						
Cat. No.	Description	HSN	GST%	Packing	Price	
712-228	Reagent Bottle Glass 1000ml	7017 9090		4	2125	
712-229	Reagent Bottle Glass 2000ml	7017 9090		2	2625	
712-230	Reagent Bottle Glass 5000ml	7017 9090		1	4375	
712-231	Amber Reagent Bottle Glass 100ml	7017 9090		12	5813	
712-232	Amber Reagent Bottle Glass 250ml	7017 9090		12	6375	
712-233	Amber Reagent Bottle Glass 500ml	7017 9090		6	3750	
712-234	Amber Reagent Bottle Glass 1000ml	7017 9090		4	4813	
712-235	Amber Reagent Bottle Glass 2000ml	7017 9090		2	4375	
712-236	Amber Reagent Bottle Glass 5000ml	7017 9090		1	8125	

SOLUTION BOTTLES

Sterile Solution Bottles are ideal for safe solution storage. The chemical resistant and Gamma irradiation sterilized ensures safe storage of your solution. Ideal for



- Transportation of Samples
- Individually Packed
- High stability & light in weight
- Chemical resistant, Wide mouth for efficient handling / Engraved Graduation

SOLUTION BOTTLES						
Cat. No.	Capacity	HSN	GST%	Packing	Price	
712-237	250 ml, Sterile	39233090		1/Pkg, 6/Pack	1900	
712-238	500 ml, Sterile	39233090		1/Pkg, 4/Pack	1900	
712-239	2000 ml, Sterile	39233090		1/Pkg, 2/Pack	1900	

BEAKER

- Sturdy With Stable Base Design
- Autoclavable
- High Quality Virgin Polypropylene
- Leak Proof & break-resistant
- Bold & Accurate Moulded Graduations
- Resistant to most acids & commonly used solvents

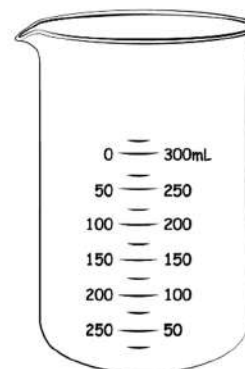

BEAKER Class B FDA Approved Raw Material						
Cat. No.	Description	HSN	GST%	Packing	Price	
712.564	100ml	3926 9099		12	540	
712.564	250ml	3926 9099		12	972	
712.564	500ml	3926 9099		6	756	
712.564	1000ml	3926 9099		4	1020	
712.564	2000ml	3926 9099		4	1800	
712.564	Assorted Kit 1	3926 9099		1	780	

Assorted Kit Pack Contains following Beakers
100ml X 2 Pcs., 250ml X 2 Pcs., 500ml X 2 Pcs., 1000ml X 1 Pcs.

DESICCATORS VACUUM



Desiccators are sealable enclosures containing desiccants used for preserving moisture-sensitive items. These are made of transparent polycarbonate (PC) cover and highly stable polypropylene (PP) base which will not shatter at max vacuum.

Available in 4 Formats

150mm
200mm
250mm
300mm

DESICCATOR VACUUM

Cat. No.	Capacity	HSN	GST %	Packing	Price
712-538	150 mm	39269099		1	1600
712-539	200 mm	39269099		1	2450
712-540	250 mm	39269099		1	3050
712-541	300 mm	39269099		1	4500

DESICCATOR VACUUM CLEAR

Cat. No.	Capacity	HSN	GST %	Packing	Price
712-542	150 mm, Clear	39269099		1	1800
712-543	200 mm, Clear	39269099		1	2950
712-544	250 mm, Clear	39269099		1	3700
712-545	300 mm, Clear	39269099		1	5500

WASH BOTTLE

- Narrow Mouth, Stable Design
- Autoclavable
- High Quality Virgin Polypropylene
- Leak Proof & break-resistant
- Bold & Accurate Moulded Graduations
- Resistant to most acids & commonly used solvents



WASH BOTTLE

Cat. No.	Description	HSN	GST%	Packing	Price
712-570	250ml WASH BOTTLES	39233090		12	936
712-571	500ml WASH BOTTLES	39233090		6	660
712-572	1000ml WASH BOTTLES	39233090		6	1080
712-573	250ml WASH BOTTLES Type II	39233090		12	1416
712-574	500ml WASH BOTTLES Type II	39233090		6	828



Wash bottle
Type-II

BOTTLE TOP DISPENSERS



SciBio Bottle Top dispensers makes the dispensing process fast, convenient and accurate. These are designed for handling liquids from a large variety of bottles in a safe way avoiding wastage. These Dispensers can be used with variety of bottles. These dispensers are offered as a complete package with variety of adapters to use it with different bottles.

Specifications

Volume Range	Graduation	A $\leq \pm$		CV \leq	
		%	μ l	%	μ l
0.5-5	0.1	0.5	25	0.1	5
1-10	0.2	0.5	50	0.1	10
2.5-25	0.5	0.5	125	0.1	25
5-50	1	0.5	250	0.1	50

A- Accuracy, CV- Coefficient of Variation

BOTTLETOP DISPENSER

Cat. No.	Description	HSN	GST%	Packing	Price
712-559	Bottle Top Dispenser 0.5-5 ml	8479 8999		1	26000
712-560	Bottle Top Dispenser 1.0-10 ml	8479 8999		1	26000
712-561	Bottle Top Dispenser 2.5-25.0 ml	8479 8999		1	32000
712-562	Bottle Top Dispenser 5.0-50.0 ml	8479 8999		1	32000
712-563	DIGITAL BOTTLE TOP DISPENSER 0.1-99.9ml	8479 8999		1	89250

VACUUM FILTRATION APPARATUS-GLASS

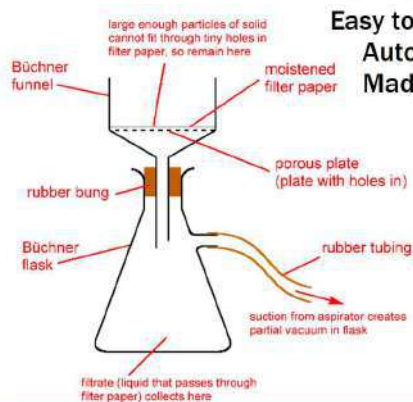

Easy to use

Autoclavable

Made from High Quality Borosilicate Glass

VACUUM FILTRATION APPARATUS-GLASS

Cat. No.	Capacity	HSN	GST%	Pack	PRICE
712-385B	VACUUM FILTRATION APPARATUS-GLASS	8421 2900		1	16250

VACUUM FILTRATION APPARATUS

Cat. No.	Capacity	HSN	GST%	Packing	Price/Pack
712-385A	Nylon MEMBRANE PORE SIZE :0.45um CAPACITY : 150ML	8421 2900		1	1450

HAND OPERATED VACUUM PUMP



Light weight

Very Easy to Use

Attain vacuum of 25"

Moulded Hard Case

Description

The Hand Operated Vacuum pumps is ideal for fast filtration.



These durable pumps quickly attain and hold vacuum of 25" (635mmHg). With SciBio Vacuum Filtration apparatus you can use these pumps for fast efficient filtration.

HAND OPERATED VACUUM PUMP

Cat. No.	Description	HSN	GST%	Packing	Price/Pack
712-385	Hand Operated Vacuum Pump	84141000		1	7000

PETRI DISH

SciBio Petri dishes are manufactured from high quality polystyrene which ensures high clarity. It has smooth, uniform wall and bottom thickness.



PETRI DISH

Cat. No.	Description	HSN	GST %	Pack	Price
712-221	Petri Dish 60mm Individual Pack, ETO Sterile	39233090		250	2975
712-222	Petri Dish 60mm Individual Pack, Gamma Sterile	39233090		250	3213
712-223	Petri Dish 90mm Individual Pack, Gamma Sterile	39233090		450	5185

PETRI DISH					
Cat. No.	Description	HSN	GST %	Pack	Price
712-221A	Petri Dish 90mm 10/Sleeve, ETO Sterile	39233090		450	5142
712-221B	Petri Dish 90mm individual Pack, Gamma Sterile	39233090		450	6205
712-221C	Petri Dish 90mm 2 Compartment Individual Pack, ETO Sterile	39233090		300	6545
712-221D	Petri Dish 90mm 2 compartment Individual Pack, Gamma sterile	39233090		300	7650
712-221E	Petri Dish 90mm 3 compartment Individual Pack, ETO Sterile	39233090		300	6545
712-221F	Petri Dish 90mm 3 compartment Individual Pack, Gamma sterile	39233090		300	7650

Extra Depth PETRI DISH



High Clarity | Uniform Wall & Bottom thickness | Available Ethylene Oxide Sterile & Gamma Irradiation Sterile | Certified Dnase Rnase Free, Non Pyrogenic

Manufactured from medical-grade virgin polystyrene which offers very high clarity. Equipped with a Guard ring which is very useful while handling dishes. These dishes have extra depth compared to standard 90mm dishes

and also the new stable lid design for better stability while stacking. Also designed to use with automated filling systems.

Petri Dish Extra Depth					
Cat. No.	Description	HSN	GST%	Pack	Price
712-609	Petri Dish 90x20mm Individual Pack, ETO Sterile	39233090		300	8850
712-610	Petri Dish 90x20mm Individual Pack, Gamma Sterile	39233090		300	10050

PETRI DISH SQUARE

High Clarity | Uniform Wall & Bottom thickness | Available Ethylene Oxide Sterile & Gamma Irradiation Sterile | Certified Dnase Rnase Free, Non Pyrogenic

Manufactured from high quality polystyrene which ensures high clarity. It has smooth, uniform wall and bottom thickness. Size : 100 X 100 X 15mm

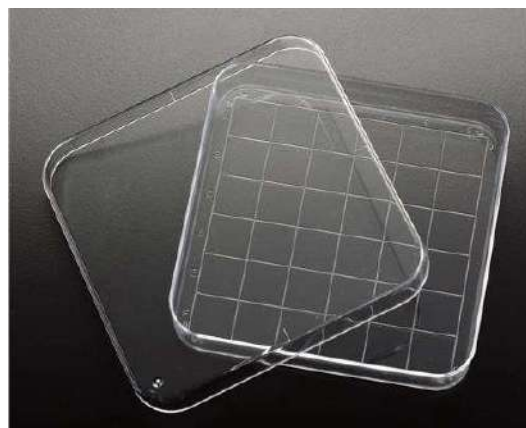

PETRI DISH SQUARE					
Cat. No.	Description	HSN	GST%	Packing	Price
712-224	Petri Dish Square Individual Pack, Gamma Sterile	39233090		150	7750
712-224A	Petri Dish Square Individual Pack, Gamma Sterile	39233090		150	8250

PCR TUBES/ PCR PLATES (HIGH PERFORMANCE)

Optical Flat Cap
Ultra Thin Wall Design
High Performance
Uniform Wall thickness



High Performance PCR Products

Cat. No.	Description	HSN	GST%	Packing	Price
712-294	PCR tube 0.2ml thin wall, optical flat cap, Clear, sterile	39269099		1000	3125
712-295	PCR tube 0.2ml thin wall, Domed cap, Clear, sterile	39269099		1000	3125
712-296	PCR tube 0.5ml thin wall, optical flat cap, Clear, sterile	39269099		1000	3750
712-297	PCR 8 strip thin wall with Flat cap Clear, Sterile	39269099		240	10750
712-298	PCR 8 strip thin wall with Domed Cap, Clear, Sterile	39269099		240	10750
712-299	PCR 8 strip thin wall White, Sterile, Flat Cap	39269099		240	15000
712-300	PCR Plate 96well, Non Skirted, Clear Sterile	39269099		25	5125
712-301	PCR Plate 96well, Non Skirted, White, Sterile	39269099		25	5125
712-302	PCR Plate 96well, Semi Skirted, Clear, Sterile	39269099		25	6875
712-303	PCR Plate 96well, Semi Skirted, White, Sterile	39269099		25	6875

PCR TUBES/ PCR PLATES (STANDARD QUALITY)



Thin wall
Frosted Flat & Domed Cap
Optimal Performance
Uniform Wall thickness

Standard PCR Product Range

Cat. No.	Description	HSN	GST%	Packing	Price/Pack
712-287	PCR tube Flat Standard 0.2ml Sterile	39269099		1000	2225
712-288	PCR tube Domed Standard 0.2ml Sterile	39269099		1000	2225
712-289	PCR Tube Strip 8 Standard Sterile	39269099		100	3865
712-290	PCR Tube Strip 12 Standard Sterile	39269099		100	3865
712-291	PCR Plate Non Skirted Elevated Well Standard	39269099		25	4375
712-292	PCR Plate Non Skirted Standard	39269099		25	4375
712-293	PCR Plate Skirted Standard	39269099		25	5625
712-294	PCR PLATE SKIRTED 384 WELL	39269099		25	25625

SEALING FILM/MAT ROLLER

The Adhesive Seal Roller and Adhesive Seal Applicator ensure even pressure is applied across the seal for a complete application to the plate

- To obtain the best sealing results when using our Adhesive Seals, we strongly recommend the use of the Adhesive Seal Roller or Adhesive Seal Applicator.
- Both application tools ensure even pressure is applied across the adhesive seal for complete and secure application to your plate, across every well.
- The handle of the Adhesive Seal Roller is made of a durable plastic, with a semi-hard padded rolling wheel.
- The straight rigid sides of the small-sized Adhesive Seal Applicator allow for even pressure application.



Mat Sealer						
Cat. No.	Capacity	HSN	GST %	Packing	Price/Pack	
E9127-2940	Microtitre Sealing Brayer	39233090		1	6957	

RESEARCH ARTICLES-FIELD



SC-24510



SC-24511



SC-24512



SC-24513



SC-24514



SC-24515

Seed Displayer						
Cat. No.	Capacity	HSN	GST %	Packing	Price/Pack	
SC-24510	Multi Cavity seed displayer	39233090		1	1945	
SC-24511	Breeding Jar Mosquito			1	450	
SC-24512	Acrylic Labels (Field)			1	280	
SC-24513	Acrylic Labels T shape			1	110	
SC-24514	Green NETS for Sunroof (Price/2 feet)			1	30	
SC-24515	Plant Identification pegs			1	50	
SC-24516	Soil pH meter			1	6500	
SC-24517	Haemocytometer			1	3500	
SC-24518	Electric Bag Sealer			1	4500	
SC-24519	Lab Coat cotton washable			1	1480	
SC-24520	Kinematic Viscosity Bath Digital			1	45980	



Soil pH meter

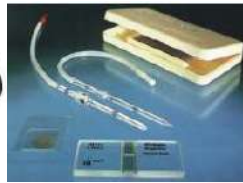

Haemocytometer



Electric Bag Sealer



Lab Coat



Kinematic Viscosity Bath

PCR RACK WITH COVER



Ideal PCR workstation
Suitable for PCR tubes, strips and Plate

PCR RACK WITH COVER					
Cat. No.	Description	HSN	GST%	Packing	Price
712-305	PCR Rack	39269099		8/pk	2063

PCR WORKBENCH RACK

Best Workbench
Stackable
Compatible with PCR Tubes, Strips and all types of plates

PCR WORKBENCH					
Cat. No.	Description	HSN	GST%	Packing	Price
712-304	PCR Workbench	39269099		5/pk	1313



BENCHTOP MINI COOLERS



Benchtop Mini Coolers maintains freezer temperature during frost-free cycles, power failures and accidental door openings. These Coolers Protect enzymes, cells, reagents and solutions by maintaining freezer temperatures. Freeze the Mini cooler at -2°C to -10°C for 24 Hours before Use. High Quality PP Material Sturdy & Rigid Construction Clear Transparent Lid Single Box for Multiple Tubes Holds 1.5ml – 30 Tubes, 0.5ml – 12 Tubes, 0.2ml

- 12 Tubes
Available in 2 formats - ICE Box Only - Gel filled ICE Box.

Benchtop Cooler					
Cat. No.	Description	HSN	GST%	Packing	Price
712-633	MINI COOLER ICE BOX	39231090		4	1600
712-634	MINI COOLER GEL FILLED BOX	39231090		2	2200
712-635	PCR Mini-Cooler Yellow OR PINK OR BLUE 2Pcs/PK	39231090		1	14090

Multi Use Rack



Multi Use Rack

Cat. No.	Description	HSN	GST%	Pack	Price
712-606	50 Places (upto 18mm Tube)	39269099		8	5925

BOX FOR MICRO CENTRIFUGE TUBES

The Micro centrifuge tube box is made of polypropylene. The tight fit cover ensures samples won't fall if box is reversed. This box is autoclavable at 121 °C & Freezable at -80 °C

Ideal for micro tubes storage
Tight fit cover ensures sample won't fall



BOX FOR MICRO-CENTRIFUGE TUBES

Cat. No.	Capacity	HSN	GST%	Packing	Price
712-598	For 0.5ml Tubes	39231090		8	2800
712-599	For 1.5 / 2ml Tubes 8 1600	39231090		8	2800
712-600	For 5ml Tubes 6 1450	39231090		6	2800

CARDBOARD CRYO BOX



These boxes are made of special type of sturdy cardboard and is most versatile and economical option for storage of Cryovials, Microtubes & Centrifuge tubes. These boxes are cold resistant and can withstand long time freezing.

Sturdy Material
Cold-resistant, withstands freezing

CARDBOARD CRYO BOX

Cat. No.	Capacity	HSN	GST%	Packing	Price/Pack
712-127	Cardboard Box for 1.8ml Tubes	39233090		24	3300
712-128	Cardboard Box for 15ml Tubes	39233090		8	1563
712-129	Cardboard Box for 50ml Tubes	39233090		8	1875

CRYOVIALS

Cryogenic vials are manufactured from special grade virgin polypropylene to withstand temperatures to -196°C . These Vials fulfill all International Standards in terms of quality and performance. Our Cryovials are External screw cap reduces risk of contamination from handling. Certified Rnase Dnase Free, Non Pyrogenic.

Warning: Do not use Cryo vials for storage in the liquid phase of liquid nitrogen.

CRYOVIALS					
Cat. No.	Capacity	HSN	GST%	Packing	Price/pk
712-091	Cryovial 2ml, External Thread, Gamma Sterile	3926 9099		250/pk	4000
712-092	Cryovial 2ml, Internal Thread Gamma Sterile	3926 9099		250/pk	4250
712-093	Cryovial 5ml, External Thread, Gamma Sterile	3926 9099		250/pk	6000
712-094	Cryovial 5ml, Internal Thread, Gamma Sterile	3926 9099		250/pk	6250
712-095	Cap Insert for Cryovial, Red / Yellow / Blue / Green	3926 9099		100/pk	238

CRYO BOX (PP)

These boxes are made of PP with a tight fitting lid which ensures samples won't fall out even if the box is reversed. These boxes can hold most brands of Cryovials as well as micro tubes. Autoclavable at 121°C and freezable at -80°C

Sturdy and rigid

Keep samples safe

Made from High Quality Polypropylene



CRYO BOX (PP)					
Cat. No.	Capacity	HSN	GST%	Packing	Price
712-802	2ml / 100 places	3923 1090		8	1900

CRYO BOX (PC)

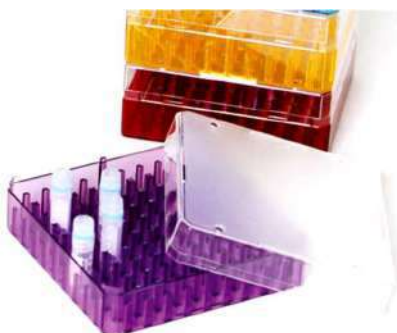

These boxes are made of PC with a tight fitting printed transparent lid for Easy Sample Identification. These boxes are meant for use in Ultra Low Temperatures.

Sturdy and rigid

Keep samples safe

Made From High Quality Polycarbonate

CRYOBOX PC					
Cat. No.	Description	HSN	GST%	Packing	Price
712-607	2ml / 25 Places	3923 1090		8	1650
712-608	2ml / 100 Places	3923 1090		8	4575

CRYO WORKSTATION



Cryo workstation is made of Polypropylene. The workstation can hold 40 Vials. These boxes can hold most brands of Cry vials as well as micro tubes. Autoclavable at 121 °C and freezable at -80 °C
Rigid & Sturdy
Made from High Quality PP
Cold-resistant, withstands freezing

40 x 2ml/5ml Cryotubes

CRYO WORKSTATION

Cat no.	Capacity	HSN	GST%	Packing	Price
712-801	Cryo Workstation	3926 9099		4	1500

WIRE RACK (MULTI USE RACK)

Multi use rack is made of polypropylene and is available in two formats. It is an ideal storage and workbench option for handling variety of tubes.

44 X 15ml tubes
21 X 50ml tubes
Autoclavable at 121 °C and
freezable at -80 °C



MULTI USE RACK

Cat. No.	Capacity	HSN	GST%	Packing	Price
712-596	T1, For 15ml Tubes	39269099		4	2800
712-597	T2, For 50ml Tubes	39269099		4	2800

RACK FOR 15ML/50ML CENTRIFUGE TUBE



This rack is most suitable where conical centrifuge tubes are in job. It has alphanumeric inscription for easy identification of test and can be easily assembled or disassembled. Withstands Autoclaving & Freezing.

18 X 15ml tubes
10 X 50ml tubes

RACK FOR 15ml/50ml CENTRIFUGE TUBE

Cat. No.	Capacity	HSN	GST%	Packing	Price/Pack
712-135	15/50ml	3926 9099		8	2750

RACK FOR 50ML CENTRIFUGE TUBE

50ml Centrifuge tube rack is made of polypropylene. It is an ideal workbench option for handling 50ml conical bottom tubes.

10 X 50ml tubes

Autoclavable at 121 °C and freezable at -80 °C



RACK FOR 50ML CENTRIFUGE TUBE					
Cat. No.	Capacity	HSN	GST%	Packing	Price
712-803	15/50ml, Type Small	3926 9099		8	2200
712-804	15/50ml, Type Small	3926 9099		4	1900

RACK FOR MICRO CENTRIFUGE TUBES

This rack is made up of ABS and is most suitable workbench proven for micro tubes.

Ideal workbench for handling microtubes
Rigid and sturdy construction

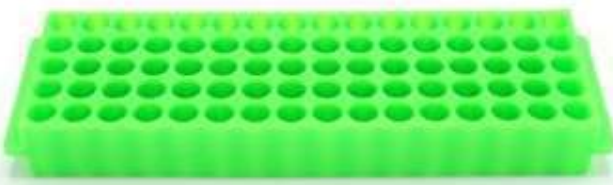

RACK FOR MICRO CENTRIFUGE TUBES					
Cat. No.	Capacity	HSN	GST%	Packing	Price/pack
712-130	0.5ml / 50 Places	3926 9099		4	1375
712-131	1.5ml / 50 Places	3926 9099		4	1563

REVERSIBLE RACK

This rack is made of polypropylene in 60 and 96 Places format. It is an ideal storage and workbench option for handling micro tubes.

Ideal for storage and bench top work
Autoclavable at 121 °C and freezable at -80 °C

Easy Identification of Samples with
Alphanumeric Inscriptions

For 0.5ml on One Side, For 1.5/2ml on other side.



REVERSIBLE RACK					
Cat. No.	Description	HSN	GST%	Packing	Price
712-805	60 Places	3926 9099		10	1800
712-806	80 Places	3926 9099		10	1900
712-807	96 Places	3926 9099		10	3000

TEST TUBE STAND

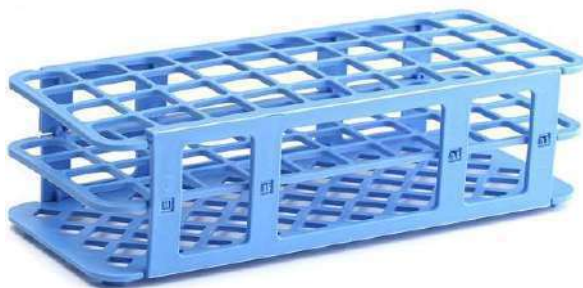

These stands are made of Acrylic / ABS material and is suitable for handling 12/13mm tubes. These racks have alphanumeric inscription for test identification.
Sturdy and Stable
Alphanumeric Inscription for test Identification

TEST TUBE STAND

Cat. No.	Capacity	HSN	GST%	Packing	Price/Pack
712-136	12/13mm 50 Place Acrylic	39269099		8	1875

UNIVERSAL RACK

These Racks are designed to support a variety of tube sizes and styles. Withstands Autoclaving and Freezing.

- 4 x 50 ml conical tubes
- 12 x 15 ml conical tubes
- 32 x 1.5/2.0 ml micro tubes
- 32 x 0.5 ml micro tubes



Universal Rack

Cat. No.	Description	HSN	GST %	Pack-ing	Price
712-601	Universal Rack	39269099		10	3200

CENTRIFUGE TUBE RACK (50ML)



Centrifuge Tube Rack (50ML)

Cat. No.	Description	HSN	GST	Packing	Price
712-605	10 Places, 50ml Centrifuge Tube Rack	39269099		8	3800

SEROLOGICAL PLATES

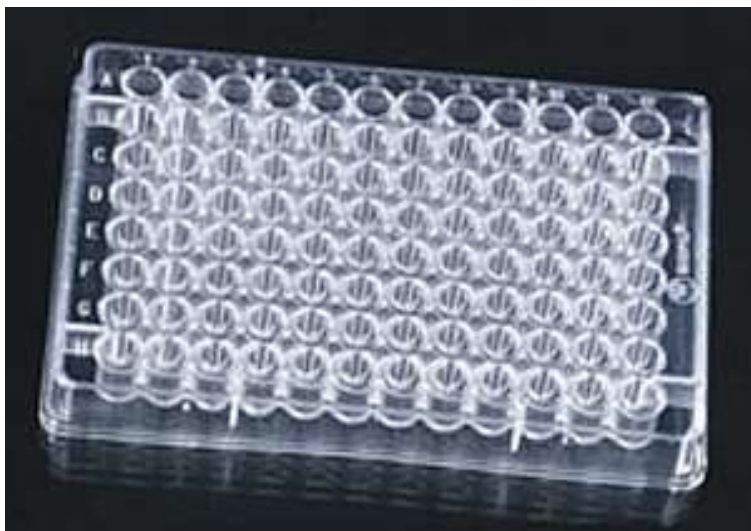

Ideal for general applications including serological dilution and other basic analysis. Made from optically clear polypropylene to ensure better visualization

SEROLOGICAL PLATES

Cat. No.	Description	HSN	GST%	Packing	Price
712-611	96 WELL FLAT BOTTOM, GAMMA STERILE	39269099		100	7750
712-612	96 WELL U BOTTOM, GAMMA STERILE	39269099		100	9375
712-613	96 WELL V BOTTOM, GAMMA STERILE	39269099		100	9375
712-614	96 WELL BLACK, FLAT BOTTOM, GAMMA STERILE	39269099		50	7250

ELISA PLATES

Plates ELISA tests , Efficient in binding assays. Free from inclusions to provide optimal results.

Uniform and smooth Well surface

Fixed flat and detachable bottom available

High and Medium Binding available

CV of transmittance is less than 5.00%



ELISA PLATES

Cat. No.	Description	HSN	GST%	Packing	Price/Pack
712-241	ELISA Plate F Bottom Detachable 8x12, Gamma Sterile	3919 9090		100	9063

DEEPWELL PLATES



Manufactured from high quality Virgin Polypropylene and is excellent for sample storage. These plates are chemical resistant to wide variety of chemicals and is compatible with most automated systems.

Individually Packed
Alpha Numeric Well Coding
Chemical resistant, Gamma Irradiation Sterilized
Compatible with most automated liquid handling system

DEEPWELL PLATES

Cat. No.	Description	HSN	GST%	Packing	Price
712-615	2.2ML STERILE, INDIVIDUAL PACK	36269099		48	14000
712-616	4.6ML STERILE, INDIVIDUAL PACK	36269099		48	16000
712-617	SEALING MAT	36269099		48	13000

CELL CULTURE FLASKS

- High transparency
- Plug Seal Cap & Vent Cap Available
- Different Growth area Available
- Uniform TC Treatment Ensures Uniform growth
- Precise Bold & Accurate Engraved Graduations
- TC Treated & Gamma Irradiation Sterile
- Certified Dnase, Rnase Free, Non Pyrogenic
- High clarity medical grade polystyrene material

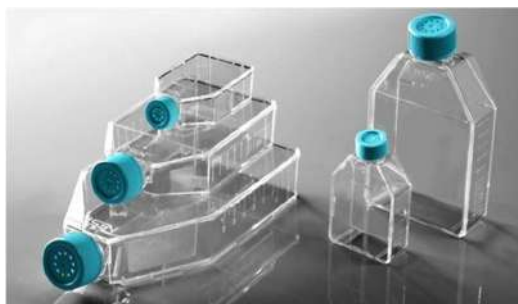

- Packaged in Zip bags
- High clarity, 100% virgin polystyrene
- Frosted writing and clear graduations
- Stackable
- Sterilized by E-Beam
- Vent caps (with breathable 0.22um membrane)
- Clear lot number for batch traceability
- Non-Pyrogenic, DNase/RNase free

Cell Culture Flasks

Cat. No.	Description	HSN	GST%	Packing	Price
712-245	25cm ² Cell Culture Flakes plug Seal Cap TC Treated Sterile	39233090		200	9250
712-246	75cm ² Cell Culture Flakes plug Seal Cap TC Treated Sterile	39233090		100	9250
712-247	175cm ² Cell Culture Flakes plug Seal Cap TC Treated Sterile	39233090		40	6875
712-248	225cm ² Cell Culture Flakes plug Seal Cap TC Treated Sterile	39233090		25	7813
712-249	25cm ² Cell Culture Flakes Vent Cap TC Treated Sterile	39233090		200	10625
712-250	75cm ² Cell Culture Flakes Vent Cap TC Treated Sterile	39233090		100	10625

Cell Culture Flasks				
Cat. No.	Description	HSN	GST%	Packing Price
712-251	175cm ² Cell Culture Flakes Vent Cap TC Treated Sterile	39233090		40 8000
712-252	225cm ² Cell Culture Flakes Vent Cap TC Treated Sterile	39233090		25 8563

CELL CULTURE FLASK (MULTI LAYER) & BIO-FACTORY



5-layer cell culture flask

- High clarity medical grade polystyrene material
 - Growth area: 870cm²
 - TC treatment for better cell attachment
 - Sterilized by E-Beam, non-pyrogenic
 - Both plug seal cap and vent cap are available
- Tips: To avoid foams and bubbles causing the media in upper layer flowing into the bottom layer, a gentle operation requested while operating the multi-layer flasks.

BioFactory™

Layer: 1 Layer / 2 Layers / 5 Layers / 10 Layers / 40 Layers



- USP Class VI grade polystyrene material
 - Nest BioFactory™ Systems are compact, multi-layer, single-use cell culture systems designed for easy scale-up cell culture applications, such as production of vaccines, monoclonal antibodies or pharmaceuticals. Versatile, easy-to-use systems for small scale research or commercial production with reduced contamination risk. Narrow mouth caps available for tubing solutions.
 - Temperature Range: Approx.-86 to+64°C
 - Sterilized by E-Beam SAL=10⁻⁶
 - Non-pyrogenic
 - Double-layer sterile bag
 - TC treated , good for cell attachment and growth
 - Clear lot number for batch traceability
- Ultrasonic welding without extrinsic ingredients. Excellent welding line design can avoid producing particles during welding. And make the biofactory stronger.
 - Vent caps with 0.22um hydrophobic filters for gas exchange without contamination.
 - Wide mouth is applicable to pour culture medium directly. Narrow mouth is applicable to operate with the aseptic pipeline.
 - Growth kinetics are the same as cells grow in the cell culture flasks. Applicable to large-scale culture adherent cells.
 - Large growing area. Just a single operate, you can cultivate a large number of cells and reduce contamination risk.
 - Applicable to automatic machine. Standardize operations to reduce batch differences.

Recommendations:

A gentle operation requested while using the biofactory to avoid air bubbles. Air bubbles will lead the culture medium flow from the upper layer to the lower layer.

NEST MULTI LAYER CULTURE FLASKS & BIO-FACTORY

Cat. No.	Description	HSN	GST%	Packing	Price/Pack
712-277	5-Layer Cell Culture Flask, Plug Seal Cap, Straight Neck, TC Treated, Sterile	39239090		8	14375
712-278	5-Layer Cell Culture Flask, Vent Cap, Straight Neck, TC Treated, Sterile	39239090		8	15625
712-279	Nest BioFactory 1 Chamber; Wide Mouth; Total culture area: 647cm ² ; TC Treated, Sterile	39269099		8	41875
712-280	Nest BioFactory 2 Chamber; Wide Mouth; Total culture area: 1279cm ² ; TC Treated, Sterile	39269099		8	50000
712-281	Nest BioFactory 5 Chamber; Wide Mouth; Total culture area: 3175cm ² ; TC Treated, Sterile	39269099		4	49375
712-282	Nest BioFactory 10 Chamber; Wide Mouth; Total culture area: 6335cm ² ; TC Treated, Sterile	39269099		6	106250
712-283	Nest BioFactory 1 Chamber; Narrow Mouth; Total culture area: 647cm ² ; TC Treated, Sterile	39269099		8	39063
712-284	Nest BioFactory 2 Chamber; Narrow Mouth; Total culture area: 1279cm ² ; TC Treated, Sterile	39269099		8	45000
712-285	Nest BioFactory 5 Chamber; Narrow Mouth; Total culture area: 3175cm ² ; TC Treated, Sterile	39269099		4	43563
712-286	Nest BioFactory 10 Chamber; Narrow Mouth; Total culture area: 6335cm ² ; TC Treated, Sterile	39269099		6	91125

CELL CULTURE PLATE

- High transparency
- Uniform growth surface in all wells
- Different growth areas available
- Alphanumeric Well coding for easy identification
- Lid enables optimal gas exchange with lowest possible evaporation
- TC Treated & Gamma Irradiation Sterile
- Certified Dnase Rnase Free, Non Pyrogenic
- High clarity, 100% virgin polystyrene
- Sterilized by E-beam
- Vacuum Plasma tissue culture treatment
- Clear lot number for batch traceability
- Peel-to-open, individually wrapped
- Markings of well coordinates available for 12, 24, 48 96 and 384 well plates
- Non-Pyrogenic, DNase/RNase Free
- The package box of Nest cell culture plates can be used as reservoirs.



CULTURE PLATES					
Cat. No.	Description	HSN	GST%	Packing	Price
712-253	6 Well Cell Culture Plate, TC Treated, Sterile	39269099		100	10750
712-254	12 Well Cell Culture Plate, TC Treated, Sterile	39269099		100	11625
712-255	24 Well Cell Culture Plate, TC Treated, Sterile	39269099		100	11625
712-256	48 Well Cell Culture Plate, TC Treated, Sterile	39269099		100	13063
712-257	96 Well Cell Culture Plate, Flat Bottom, TC Treated, Sterile	39269099		100	10500
712-258	96 Well Cell Culture Plate, U-bottom, TC Treated, Sterile	39269099		100	15000
712-259	96 Well Cell Culture Plate, V-bottom, TC Treated, Sterile	39269099		100	15000
712-260	384 Well Cell Culture Plate, clear, TC Treated, Sterile	39269099		100	30625

CELL CULTURE DISH



- Excellent Clarity
- Uniform Surface treatment
- Uniform growth surface
- Different growth Areas available
- TC Treated & Gamma Irradiation Sterile
- Certified Dnase Rnase Free, Non Pyrogenic
- High clarity polystyrene
- Ideal for all types of culturing where microscopic observation is required. Numeric marks on the bottom of each dish allow users to identify the location of cells.
- Flat transparent surface for distortion-free observation
- Vacuum plasma TC treatment, excellent cell adherence
- Stackable for easy storage and handling
- Sterilized by E-Beam
- Non-pyrogenic

CULTURE DISH					
Cat. No.	Description	HSN	GST	Packing	Price
712-261	35mm Cell Culture Dish, 20Pcs./Pkg, TC Treated, Sterile	39269099		500	7750
712-262	60mm Cell Culture Dish, 20Pcs./Pkg, TC Treated, Sterile	39269099		500	9000
712-263	90mm Cell Culture Dish, 10Pcs./Pkg, Non Treated, Sterile	39269099		500	10625
712-264	90mm Cell Culture Dish, 10Pcs./Pkg, TC Treated, Sterile	39269099		500	13750
712-265	100mm Cell Culture Dish, 5Pcs./Pkg, TC Treated, Sterile	39269099		300	8750
712-266	150mm Cell Culture Dish, 5Pcs./Pkg, TC Treated, Sterile	39269099		100	11250

MAGENTA BOXES, TRANSPARENT

These Racks are designed to support a variety of tube sizes
 Size: 65 x 65 x 100 mm
 Pack size: 12
 Material : Polycarbonate with PP cap, Colour - Transparent



Magenta Boxes					
Cat. No.	Description	HSN	GST %	Pack- ing	Price
PB1091	MAGENTA BOXES, TRANSPARENT	39269099		12	1280

CAP FOR JAM BOTTLE



Screw Type PACK SIZE : 600
 Press Type PACK SIZE : 500
 M.O.C. PP, Colour- Milky White

CAP FOR JAM BOTTLE					
Cat. No.	Description	HSN	GST %	Pack- ing	Price
PB1092S	Screw Type cap	39269099		600	6500
PB1092P	Press Type cap	39269099		500	4000

TISSUE CULTURE JAM BOTTLE

400/500 gm bottles 64 1600.00
 Suitable for Pack Size
 M.O.C. PP, Colour- Milky White



Tissue Culture Jam Bottle					
Cat. No.	Description	HSN	GST %	Pack	Price
PB1093	400/500gm bottles	39269099		64	2000

PLANTATION POTS



PB1094B

Plantation Pots					
Cat. No.	Description (Dia in mm)	HSN	GST%	Pack	Price
PB1094A	100 x 100	39269099		20	2000
PB1094A	150 x 150	39269099		20	1000
PB1094A	200 x 200	39269099		20	1600
PB1094A	250 x 250	39269099		20	2800
PB1094A	300 x 300	39269099		20	5000
PB1094B	for Conveyor system 35cm ht. x 19 cm dia. Bot. x 23 cm dia top	39269099		20	6500

Liquid Handling Systems

MICROPIPETTES

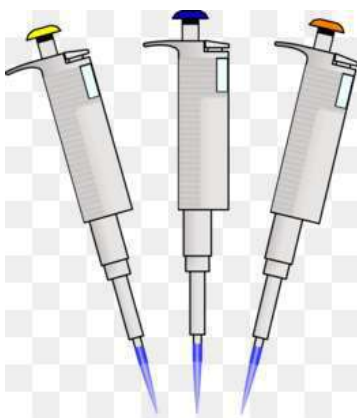

Pristine Biomedical PRISTIPET Single-Channel Pipettes

- Designed and constructed for the low-contamination transfer of liquids, in particular for samples from the human body and for reagents within the scope of an in-vitro diagnostic application in order to allow the in-vitro diagnostic medical device to be used as intended.
- in-vitro diagnostic device according to Directive 98/79/EC of the European Parliament and the Council.
- Intended exclusively for indoor use and for operation by qualified staff.

MICROPIPETTES Variable Volume Single Channel

Cat. No.	Description(Dia in mm)	HSN	GST %	Pack-ing	Price
PB1114A	0.2-2 μ l	39269099		20	16910
PB1114C	0.5-5 μ l	39269099		20	16910
PB1114D	1-10 μ l	39269099		20	16910
PB1114E	2-20 μ l	39269099		20	16910
PB1114F	5-50 μ l	39269099		20	16910
PB1114G	10-100 μ l	39269099		20	16910
PB1114H	20-200 μ l	39269099		20	16910
PB1114J	100-1000 μ l	39269099		20	16910
PB1114K	0.5-5ml	39269099		20	16910
PB1114L	1-10ml	39269099		20	16910

SCISEAL PIERCEABLE SEALING FILM (FOR GENERAL APPLICATION)



- Easily Pierceable, Inert and Chemical resistant
- Protect samples short-term and limit evaporation
- Excellent Films for Sample Recovery
- EZ-Pierce and Zone free films are 70 μ m thick , X Pierce film is 100 μ m.
- Functional temperature ranges -40 $^{\circ}$ C to +90 $^{\circ}$ C
EZ-Pierce films are easily pierceable by robotic probes and pipette tips for sample recovery. Zone-

Free™ films feature adhesive-free top layer with a inert white polypropylene/adhesive sublayer. The easy-piercing top layer allows direct sample recovery with pipette tips without adhesive fouling and minimizes adhesive contact with samples. X-Pierce™ films are designed for temporary protection of samples in multiwell plates. Precut "X" over each well creates four flaps that easily bend downward when pushed by pipette tip allowing sample access without adhesive fouling. The flaps return to their original position after sampling for continued protection.

PIERCEABLE SEALING FILMS (For General Applications)					
Cat. No.	Description	HSN	GST%	Packing	Price/Pack
712-417	EZ Pierce Films Sterile	3919 9090		50Pcs./Pack	6250
712-418	Zone Free Films Sterile	3919 9090		50Pcs./Pack	13125
712-419	X-pierce Films Sterile	3919 9090		100Pcs./Pack	11875

SCISEAL SEALING FILMS FOR CELL CULTURE PLATES AND DEEP WELL PLATES

For Culture Plates

Allows uniform air/gas exchange

Non-cytotoxic, highly gas permeable

Easily pierceable with pipette tips

*Recommended for temperatures from -20°C to +80°C

114µm hydrophobic porous film with medical-grade adhesive and is suitable for Culture plates.

These seals are known as Breathable Sealing Films and is most suitable where gas exchange is necessary for cell and bacterial growth. These films allows uniform gas exchange in all wells and minimize evaporation.

AERA SEAL & CLASSIC SEAL (FOR CULTURE & ELISA PLATES)					
Cat. No.	Description	HSN	GST%	Price/Pack	Price/Pack
712-410	Aera Seal Sterile	3919 9090		100Pcs./Pack	8125
712-411	Classic Plate Seal, Sterile	3919 9090		100Pcs./Pack	8125
712-412	Classic Seal Mini Strips Sterile	3919 9090		100Pcs./Pack	5313

SEALING FILMS FOR COLD STORAGE

Aluma Seals are Made up of soft non-permeable aluminum with strong medical-grade adhesive to eliminate the need for heat-sealing devices. These films protects samples from evaporation during thermal cycling & is best option for cold storage down to -80°C.



ALUMA SEALS (FOR PCR & COLD STORAGE)					
Cat. No.	Description	HSN	GST%	Packing	Price/Pack
712-416	Alumna Seal 96 Sterile	3919 9090		100Pcs./Pack	7750

MULTIWELL SEALING PAD/FILM (SPECIALITY PRODUCT)

Adhesive tape sheets for sealing multiwell plates and blocks



These adhesive tape sheets are highly suited for sealing 96-well plates and 96-well blocks for easy mixing without cross-contamination.

Product features

- Tape pads are intended for sealing unused portions of a 96-well solid phase extraction plate during vacuum processing to enable vacuum to be uniformly applied to each well being used
- Use a clean sheet each time for maximum sealing ability
- These tape sheets are not intended for sealing collection plates prior to sample injection because the adhesive

may clog the injection needle

- These products are intended for use during scientific research only and are not intended for use in medical devices or in assessment and treatment of clinical patients

Product description

These pads are intended for sealing unused portions of a 96-well solid phase extraction plate during vacuum processing to enable vacuum to be uniformly applied to each well being used. Use a clean sheet each time for maximum sealing ability. These tape sheets are not intended for sealing collection plates prior to sample injection because the adhesive may clog the injection needle. These products are intended for use during scientific research only and are not intended for use in medical devices or in assessment and treatment of clinical patients.

Multiwell Sealing Pad/Film(Speciality Product)

Cat. No.	Description	HSN	GST%	PACKING	Price/Pack
PB-3M-SF	3M Sealing pad for Multiwell Plates 100			1	6530

CULTURE TUBE

Excellent Clarity

Uniform growth surface

Different growth areas available

CULTURE TUBE

Cat. No.	Description	HSN	GST%	Packing	Price
712-267	Culture Tube 12x100mm, With Plug Cap, Non Treated, Gamma Sterile	39269099		2500	9938
712-268	Culture Tube 16x100mm, With Plug Cap, Non Treated, Gamma Sterile	39269099		2500	17500



CULTURE TUBE, GLASS

Excellent Clarity
Uniform growth surface
Different growth areas available



Culture Tube, Glass						
Cat. No.	Description	HSN	GST%	Packing	Price	
712-622	Culture Tube, 5ml, Glass, Clear, 'U' bottom, with cap	70179090		500	19500	
712-623	Culture Tube, 10ml, Glass, Clear, 'U' bottom, with cap	70179090		500	23400	
712-624	Culture Tube, 30ml, Glass, Clear, 'U' bottom, with cap	70179090		500	27300	
712-625	Culture Tube, 60ml, Glass, Clear, 'U' bottom, with cap	70179090		500	36400	
712-626	Culture Tube, 5ml, Glass, Amber, 'U' bottom, with cap	70179090		500	39000	
712-627	Culture Tube, 10ml, Glass, Amber, 'U' bottom, with cap	70179090		500	45500	
712-628	Culture Tube, 30ml, Glass, Amber, 'U' bottom, with cap	70179090		500	58500	
712-629	Culture Tube, 60ml, Glass, Amber, 'U' bottom, with cap	70179090		500	89700	

TEST TUBE, GLASS

TEST TUBES, GLASS						
Cat. No.	Description	HSN	GST%	Packing	Price	
712-630	12x75MM, CLEAR GLASS, U bottom, with cap	70179090		500	3575	
712-630	12X100MM, CLEAR GLASS, U bottom, with cap	70179090		500	4453	
712-630	15x125MM, CLEAR GLASS, U bottom, with cap	70179090		500	6175	
712-630	15x150MM, CLEAR GLASS, U bottom, with cap	70179090		500	6663	
712-630	18x150MM, CLEAR GLASS, U bottom, with cap	70179090		500	7800	
712-630	25x100MM, CLEAR GLASS, U bottom, with cap	70179090		500	10238	
712-630	25x150MM, CLEAR GLASS, U bottom, with cap	70179090		500	13000	
712-630	25x200MM, CLEAR GLASS, U bottom, with cap	70179090		500	16900	
712-630	32x200MM, CLEAR GLASS, U bottom, with cap	70179090		500	24700	
712-630	38x200MM, CLEAR GLASS, U bottom, with cap	70179090		250	16250	



CELL CULTURE DISH, GLASS BOTTOM



- Excellent Clarity
- Suitable for live cell observation
- Special bottom for easy grip
- Medical adhesive to guarantee non-cytotoxicity
- TC treated & Gamma irradiation sterile
- Certified Dnase, Rnase Free, Non pyrogenic
- Used for cell observation in Confocal microscope, high resolution microscope, differential interface contrast microscope, polarized light microscope and phase contrast microscope

Cell Culture Dish, Glass Bottom

Cat. No.	Description	HSN	GST%	Packing	Price
712-618	Cell Culture Dish, Glass Bottom, 15mm, 10pcs/Pkg, TC treated, sterile	39269099		200	32900
712-619	Cell Culture Dish, Glass Bottom, 20mm, 10pcs/Pkg, TC treated, sterile	39269099		200	32900
712-620	Cell Culture Plate, Glass Bottom, 6 well, 20mm 1Pcs/Pkg, TC treated, sterile	39269099		10	32200
712-621	Cell Culture Plate, Glass Bottom, 24 well, 10mm 1Pcs/Pkg, TC treated, sterile	39269099		10	32200

INOCULATION LOOPS & SPREADERS

High flexibility
Sterilized
Assure uniform sample quantity
Provide Easy Access to Samples/Growth Surface
Gamma Irradiation Sterile
Certified Dnase/Rnase Free, Non Pyrogenic



Inoculation Loop & Needle



Cell Lifter

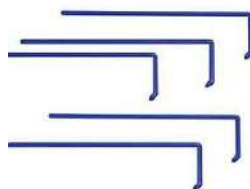

Cell Spreader L shape



Cell Scraper



Cell Spreader T Shape

INOCULATION LOOPS & SPREADERS

Cat. No.	Description	HSN	GST	Packing	Price/Pack
712-269	Inoculation loops 1ul, 1/pkg	39269099		100	488
712-270	Inoculation loops 1ul, 10/pkg	39269099		100	425
712-271	Inoculation loops 10ul, 1/pkg	39269099		100	488
712-272	Inoculation loops 10ul, 10/pkg	39269099		100	425
712-273	L spreaders 10/pkg	39269099		100	1063

INOCULATION LOOPS & SPREADERS					
Cat. No.	Description	HSN	GST	Packing	Price/Pack
712-274	T spreaders 10/pkg	39269099		100	1750
712-275	Cell Scrapper 250mm Individual Pack	39269099		200	11875
712-276	Cell Scrapper 400mm Individual Pack	39269099		200	15625
712-631	Inoculation Loop Needle	39269099		100	695
712-632	Cell Lifter	39269099		50	1500

SYRINGE FILTERS

**Bulk Packing for Non Sterilized
Individual Pack for Sterilized**



**2 pore size
0.22um,
0.45um
available
2 Housing Dia.
13mm , 25mm
available**



**6 membrane Options PVDF, PES, MCE,
PTFE, NYLON6, NYLON66**

Syringe filters are cost-effective solution

for efficient filtration of aqueous and organic solutions and is widely used for applications in biotechnology, pharmaceutical, agricultural, environmental laboratories. With High quality PP housing and we have different options of Membranes in Filtration range are available like Nylon 6, Nylon 66, PES, PTFE, MCE and PVDF in order to satisfy different research requirements.

SYRINGE FILTERS (Non Sterile)						
Cat. No.	Membrane	HSN	GST%	Dia	Pore Size	Price/Pack
712-306	MCE , 100/Pack	84212900		13mm	0.45um	2125
712-307	MCE , 100/Pack	84212900			0.22um	2125
712-308	MCE , 100/Pack	84212900		25mm	0.45um	2813
712-309	MCE , 100/Pack	84212900			0.22um	2813
712-310	CA, 100/Pack	84212900			0.45um	2625
712-311	CA, 100/Pack	84122900		13mm	0.22um	2625
712-312	CA, 100/Pack	84122900			0.45um	3625
712-313	CA, 100/Pack	84122900		25mm	0.22um	3625
712-314	Nylon6 , 100/Pack	84122900		13mm	0.45um	2438
712-315	Nylon6 , 100/Pack	84122900			0.22um	2438
712-316	Nylon6 , 100/Pack	84122900		25mm	0.45um	3563
712-317	Nylon6 , 100/Pack	84122900			0.22um	3563
712-318	Nylon66 , 100/Pack	84122900		13mm	0.45um	2750
712-319	Nylon66 , 100/Pack	84122900			0.22um	2750
712-320	Nylon66 , 100/Pack	84122900		25mm	0.45um	4250
712-321	Nylon66 , 100/Pack	84122900			0.22um	4250
712-322	PES , 100/Pack	84122900		13mm	0.45um	3125
712-323	PES , 100/Pack	84122900			0.22um	3125

SYRINGE FILTERS (Non Sterile)						
Cat. No.	Membrane	HSN	GST%	Dia	Pore Size	Price/Pack
712-324	PES , 100/Pack	84122900		25mm	0.45um	4000
712-325	PES , 100/Pack	84122900			0.22um	4000
712-326	PTFE , 100/Pack	84122900		13mm	0.45um	3688
712-327	PTFE , 100/Pack	84122900			0.22um	3688
712-328	PTFE , 100/Pack	84122900		25mm	0.45um	4813
712-329	PTFE , 100/Pack	84122900			0.22um	4813
712-330	PVDF , 100/Pack	84122900			0.45um	3938
712-331	PVDF , 100/Pack	84122900		13mm	0.22um	3938
712-332	PVDF , 100/Pack	84122900		25mm	0.45um	4938
712-333	PVDF , 100/Pack	84122900			0.22um	4938

SYRINGE FILTERS STERILE

SYRINGE FILTERS (Sterile)						
Cat. No.	Membrane	HSN		Dia	Pore Size	Price/Pack
712-334	CA, Sterile 100/Pack	8421 2900		13mm	0.45um	6875
712-335	CA, Sterile 100/Pack	8421 2900		13mm	0.22um	6875
712-336	CA, Sterile 50/Pack	8421 2900		25mm	0.45um	5250
712-337	CA, Sterile 50/Pack	8421 2900		25mm	0.22um	5250
712-338	Nylon66 , Sterile 100/Pack	8421 2900		13mm	0.45um	6875
712-339	Nylon66 , Sterile 100/Pack	8421 2900		13mm	0.22um	6875
712-340	Nylon66 , Sterile 50/Pack	8421 2900		25mm	0.45um	5250
712-341	Nylon66 , Sterile 50/Pack	8421 2900		25mm	0.22um	5250
712-342	PES , Sterile 100/Pack	8421 2900		13mm	0.45um	6875
712-343	PES , Sterile 100/Pack	8421 2900		13mm	0.22um	6875
712-344	PES , Sterile 50/Pack	8421 2900		25mm	0.45um	5250
712-345	PES , Sterile 50/Pack	8421 2900		25mm	0.22um	5250
712-346	PTFE , Sterile 100/Pack	8421 2900		13mm	0.45um	6875
712-347	PTFE , Sterile 100/Pack	8421 2900		13mm	0.22um	6875
712-348	PTFE , Sterile 50/Pack	8421 2900		25mm	0.45um	5250
712-349	PTFE , Sterile 50/Pack	8421 2900		25mm	0.22um	5250
712-350	PVDF , Sterile 100/Pack	8421 2900		13mm	0.45um	6875
712-351	PVDF , Sterile 100/Pack	8421 2900		13mm	0.22um	6875
712-352	PVDF , Sterile 50/Pack	8421 2900		25mm	0.45um	5250
712-353	PVDF , Sterile 50/Pack	8421 2900		25mm	0.22um	5250

MEMBRANE FILTERS

Available Sterile

2 pore size 0.22um, 0.45um available

6 membrane Options PVDF, PES, MCE, PTFE, NYLON6, NYLON66

Membrane filters are known for cost-effective and efficient filtration of aqueous and organic solutions and is widely used for applications in biotechnology, pharmaceutical, agricultural, environmental laboratories. Different options of Membranes in Filtration range are available like Nylon 6, Nylon 66, PES, PTFE and MCE in order to satisfy different research requirements.



MEMBRANE FILTERS					
Cat. No.	Membrane	HSN	Dia	Pore Size	Price/Pack
712-354	MCE, 100/pkg	8421 2900	47mm	0.45um	2000
712-355	MCE, 100/pkg	84212900	47mm	0.22um	2000
712-356	CA, 100/pkg	84212900	47mm	0.45um	3688
712-357	CA, 100/pkg	84212900	47mm	0.22um	3688
712-358	Nylon6 , 100/pkg	84212900	47mm	0.45um	5000
712-359	Nylon6 , 100/pkg	84212900	47mm	0.22um	5000
712-360	Nylon66 , 100/pkg	84212900	47mm	0.45um	10250
712-361	Nylon66 , 100/pkg	84212900	47mm	0.22um	10250
712-362	PES, 100/pkg	84212900	47mm	0.45um	7688
712-363	PES, 100/pkg	84212900	47mm	0.22um	7688
712-364	PTFE , 100/pkg	84212900	47mm	0.45um	7738
712-365	PTFE , 100/pkg	84212900	47mm	0.22um	7738
712-366	PVDF , 100/pkg	84212900	47mm	0.45um	7813
712-367	PVDF , 100/pkg	84212900	47mm	0.22um	7813
712-368	CA , Sterile 200/pkg	84212900	47mm	0.45um	10625
712-369	CA , Sterile 200/pkg	84212900	47mm	0.22um	10625
712-370	Nylon6, Sterile 200/pkg	84212900	47mm	0.45um	10625
712-371	Nylon6, Sterile 200/pkg	84212900	47mm	0.22um	10625
712-372	PES , Sterile 200/pkg	84212900	47mm	0.45um	18125
712-373	PES , Sterile 200/pkg	84212900	47mm	0.22um	18125
712-374	PTFE, Sterile 200/pkg	84212900	47mm	0.45um	18125
712-375	PTFE, Sterile 200/pkg	84212900	47mm	0.22um	18125
712-376	PVDF , Sterile 200/pkg	84212900	47mm	0.45um	18125
712-377	PVDF , Sterile 200/pkg	84212900	47mm	0.22um	18125

FILTER PAPERS



- High quality and High degree of purity
- Efficient filtration used for general filtration purpose and are categorized into different numbers depending on purity, hardness, and chemical resistance.
- Made up of extremely pure cotton linters, containing nearly 100% alpha grade cellulose.

Technical Details (Qualitative filter papers)					
Grade	Basic weight (g/m ²)	Filter Speed	Wet Bursting Strength (≥ mm H ₂ O)	Ash Content (<%)	Pore Size (μm)
Grade 4 fast	80 ± 4	≤ 35	120	0.15	20 ~ 25
Grade 1 Medium		≤ 70	140		15 ~ 20
Grade 5 Slow		≤ 140	180		10 ~ 15
Technical Details (Quantitative filter papers)					
Grade	Basic weight (g/m ²)	Filter Speed	Wet Bursting Strength (≥ mm H ₂ O)	Ash Content (<%)	Pore Size (μm)
Grade 41 fast	80 ± 4	≤ 35	120	0.01	20 ~ 25
Grade 40 Medium		≤ 70	200		15 ~ 20
Grade 42 Slow		≤ 140	280		10 ~ 15

Filter Papers Qualitative						
Cat. No.	Size (mm)	HSN	GST%	Pcs/Pack	Pks/Box	Price/Pack
712-386	90 (Grade-4) fast	4823 2000		100pcs	5	2063
712-387	110 (Grade-4) fast	4823 2000		100pcs	5	2594
712-388	125 (Grade-4) fast	4823 2000		100pcs	5	3063
712-389	150 (Grade-4) fast	4823 2000		100pcs	5	3938
712-390	90 (Grade-1) medium	4823 2000		100pcs	5	1906
712-391	110 (Grade-1) medium	4823 2000		100pcs	5	2188
712-392	125 (Grade-1) medium	4823 2000		100pcs	5	2656
712-393	150 (Grade-1) medium	4823 2000		100pcs	5	3156
712-394	90 (Grade-5) slow	4823 2000		100pcs	5	2688
712-395	110 (Grade-5) slow	4823 2000		100pcs	5	3219
712-396	125 (Grade-5) slow	4823 2000		100pcs	5	3969
712-397	150 (Grade-5) slow	4823 2000		100pcs	5	5500

Filter Papers Quantitative						
712-398	90 (Grade-41) fast	4823 2000		100pcs	5	4906
712-399	110 (Grade-41) fast	4823 2000		100pcs	5	6563
712-400	125 (Grade-41) fast	4823 2000		100pcs	5	7813
712-401	150 (Grade-41) fast	4823 2000		100pcs	5	10688
712-402	90 (Grade-40) Medium	4823 2000		100pcs	5	4688
712-403	110(Grade-40) Medium	4823 2000		100pcs	5	5844
712-404	125(Grade-40) Medium	4823 2000		100pcs	5	6938
712-405	150(Grade-40) Medium	4823 2000		100pcs	5	9438
712-406	90(Grade-42) Slow	4823 2000		100pcs	5	4813
712-407	110(Grade-42) Slow	4823 2000		100pcs	5	6188
712-408	125(Grade-42) Slow	4823 2000		100pcs	5	7719
712-409	150(Grade-42) Slow	4823 2000		100pcs	5	9563

PRISTINE LATEX EXAM GLOVES



- Natural Rubber~ Biodegradable
- Slightly Powdered
- Better Sensitivity & Better Elasticity than Nitrile Gloves
- Balance of Comfort & Protection
- Meets Standards for Medical Exam Use
- Mfg Acc. to Malaysian Standards
- Meets CE, ISO 9001, ISO 13485, ASTM Intl. Standards

Made In Malaysia



ISO 9001:2008 ISO 13485:2003 HACCP



PRISTINE LATEX EXAM GLOVES

Cat. No.	Description	Packing	Price/Pack
712-453	Latex Gloves Small	100 Pcs/Box, 10 Box/Pack	8500
712-454	Latex Gloves Medium	100 Pcs/Box, 10 Box/Pack	8500
712-455	Latex Gloves Large	100 Pcs/Box, 10 Box/Pack	8500

PRISTINE LITE NITRILE GLOVES

Nitrile Glove Range products are formulated with 100% Nitrile which contains no natural rubber latex protein and thus is ideal for persons who are allergic to latex.

- Soft Nitrile Formulation
- Powder Free
- Light in Weight
- LATEX/PROTEIN FREE & POWDER FREE
- Textured fingertips for better Grip
- Balance of Comfort & Protection
- Provides precise grip in both dry & Wet conditions



Nytro+ Lite

Cat. No.	Description	Packing	Price/Pack
712-423	Nytro+ Lite Nitrile Gloves Small	10 x 100	9625
712-424	Nytro+ Lite Nitrile Gloves Medium	10 x 100	9625
712-425	Nytro+ Lite Nitrile Gloves Large	10 x 100	9625

VINYL GLOVES

- Soft touch , Latex Free
- Powdered
- Ambidextrous – fits either Hand
- Durable & Stretchable
- Excellent Grip properties
- Recommended for Medical examination, Laboratories, Household, etc

Vinyl Gloves			
Cat. No.	Description	Packing	Price/Pack
712-450	Vinyl Gloves Small	10 x 100	7500
712-451	Vinyl Gloves Medium	10 x 100	7500
712-452	Vinyl Gloves Large	10 x 100	7500

SAFESKIN PURPLE NITRILE GLOVES

Safeskin Purple Nitrile Powder-Free Exam Gloves



- These unique purple gloves combine the durability of nitrile with superb comfort and fit. Powder free design reduces the risk of powder-related interference during lab work. These gloves are ideal product to protect your exposure to



bacteria, viruses and chemicals. It also enhances your ability to offer maximum security against cross-contamination.

- Its unique purple color provides quick, visual differentiation from natural rubber latex and other synthetic gloves.
- Its textured fingertips enhanced wet and dry grip.
- Custom design enhance comfort and fit.
- These gloves are powder free, minimizing the potential for powder related complications, irritation and dermatitis.
- Powder-free
- Non-sterile
- Textured fingertips
- Beaded cuff

Safeskin Nitrile Gloves					
Cat. No.	Description	HSN	GST%	PACKING	Price/Pack
211-146	Safe Skin, NITRILE, (Powder Free) Large	62114300		10 X 100	23854
211-147	Safe Skin, NITRILE, (Powder Free) Medium	62114300		10 X 100	23854
211-148	Safe Skin, NITRILE, (Powder Free) Small	62114300		10 X 100	23854

Note: Please check availability & price before ordering

MICROFLEX GLOVES

Microflex Supreno Se Nitrile Glove, Powder Free, 9.6" Length, 4.7 Mils Thick (Pack Of 1000)

- Nitrile Provides Better Elasticity Than Vinyl, Better Puncture Resistance Than Latex Or Vinyl, And Better Abrasion Resistance Than Chloroprene
- Textured Along The Length Of The Fingers For Improved Grip Compared To A Glove With Textured Fingertips, And An External Polymer Coating Helps Prevent Tapes And Adhesives From Sticking To The Glove
- Palm Thickness Is 4.7 Mils And Finger Thickness Is 7.1 Mils, And Standard Length Glove Is 9.6" Long And Has A Beaded Wrist Cuff That Is 3.9 Mils Thick
- Chlorinated Glove Allows For Quick Donning, Particularly In Wet Environments
- Powder Free Glove Leaves No Residue, Helping To Reduce The Likelihood Of Spreading Bacteria Compared To A Powdered Glove



Microflex® Diamond Grip Plus™ 6.3 mil Powder-Free 9" Latex Exam Gloves, 100/Box, 10box/ case

Great strength – great dexterity



Give workers the glove toughness they need for work without limiting their motion or dexterity. This is the disposable exam glove that fits the bill.

- Increased glove strength – greater glove dexterity
- Extended beaded cuff provides increased wrist protection
- Diamond Grip Plus™ textured for a secure grip
- Specially formulated Microflex® exam gloves reduce the risk of adverse latex reactions
- Powder-free agent helps each glove go on fast
- 6.3 mil fingertip thickness, 5.1 mil palm thickness
- 9" length
- 100 gloves per box/ 10 boxes per case

Microflex Gloves					
Cat. No.	Description	HSN	GST%	PACKING	Price/Pack
DGP-INT-L	Diamond Grip Plus LATEX (Powder Free) Large, 100Pc/Bx, 10Bx/Cs	40151900		1	11600
DGP-INT-M	Diamond Grip Plus LATEX (Powder Free) Medium, 100Pc/Bx, 10Bx/Cs	40151900		1	11600
DGP-INT-S	Diamond Grip Plus LATEX (Powder Free) Small, 100Pc/Bx, 10Bx/Cs	40151900		1	11600
DGP-INT-XS	Diamond Grip Plus LATEX (Powder Free) Extra Small, 100Pc/Bx, 10Bx/Cs	40151900		1	11600
SU-INT-L	Supreno SE, NITRILE, Powder Free, Large, 100Pc/Bx, 10Bx/Cs	40151900		1	11700

Microflex Gloves						
Cat. No.	Description	HSN	GST%	PACKING	Price/Pack	
SU-INT-M	Supreno SE, NITRILE, Powder Free, Medium, 100Pc/Bx, 10Bx/Cs	40151900		1	11700	
SU-INT-S	Supreno SE, NITRILE, Powder Free, Small, 100Pc/Bx, 10Bx/Cs	40151900		1	11700	
SU-INT-XS	Supreno SE, NITRILE, Powder Free, Extra Small, 100Pc/Bx, 10Bx/Cs	40151900		1	11700	

Note: Please check availability & price before ordering

CENTRIFUGE TUBES

- SciBio Premium quality Centrifuge tubes
- Made from the top-quality medical grade 100% virgin polypropylene
- Assures excellent transparency, chemical resistibility and have Low retention surface.
- Made with fully automatic machines to ensure products dnase, rnase free.
- Different Sterile options & Non Sterile options are available for different research requirements.
- Graduations and writing areas are clear and are chloroform resistant.
- Leak-proof and autoclavable at 121 °C/freezable to -80 °C.

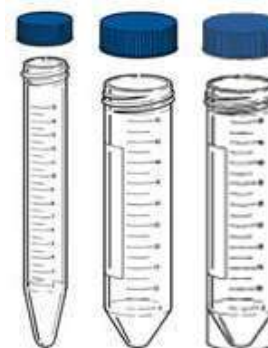

Leak proof | High Clarity | RCF up to 12000g | Printed White frosted Large writing area | BOLD Black & White Colour Graduations

CENTRIFUGE TUBE (PREMIUM QUALITY)						
Cat. No.	Description	HSN	GST %	Packing	Price/Pack	
712-068	15ml Non Sterile	39269099		1000/Pack	8750	
712-069	15ml ETO Sterile	39269099		1000/Pack	9813	
712-070	50ml Non Sterile	39269099		500/Pack	6219	
712-071	50ml ETO Sterile	39269099		500/Pack	8688	
712-072	15ml Gamma Sterile	39269099		1000/Pack	10188	
712-073	50ml Gamma Sterile	39269099		500/Pack	7800	

CENTRIFUGE TUBE SELF STANDING						
Cat. No.	Capacity	HSN	GST %	Packing	Price/Pack	
712-085	50ml	39269099		500/Pack	9063	
712-086	50ml, Gamma Sterile	39269099		500/Pack	11563	

MICROCENTRIFUGE TUBES



The SECURE CAP Micro centrifuge tubes are made from high quality PP material which assures high transparency and clear graduations. These tubes have consistent wall thickness with tight fit attached



caps which ensures leak proof operation. These tubes are available either sterilized or non-sterilized in order to satisfy the different research requirements.

MICRO CENTRIFUGE TUBE

Cat. No.	Packing	HSN	GST %	Packing	Price/Pack
712-074	0.5ml 1000pcs/box	39269099		10 boxes	6413
712-075	1.5ml 500Pcs/Box	39269099		10 boxes	9438
712-076	2ml 500 Pcs/Box	39269099		10 boxes	5264
712-077	5ml 200 Pcs/Box	39269099		5 boxes	3902
712-077A	10ml 200 Pcs/Box	39269099		2 boxes	3146
712-078	0.5ml, Gamma Sterile,1000pc	39269099		10 boxes	7506
712-079	1.5ml, Gamma Sterile,500pcs	39269099		10 boxes	10879
712-080	2ml, Gamma Sterile,500pcs	39269099		10 boxes	6607
712-081	5ml, Gamma Sterile,200pcs	39269099		5 boxes	5718
712-081A	10ml 200 Pcs/Bag,200pcs	39269099		2 boxes	4037

MICRO CENTRIFUGE TUBE (PREMIUM QUALITY)

MICRO CENTRIFUGE TUBE (PREMIUM QUALITY)

Cat. No.	Capacity	HSN	GST %	Packing	Price/Pack
712-082	0.5ml Clear, Gamma Sterile ,1000pcs	39269099		5 bx	9680
712-083	1.5ml Clear, Gamma Sterile,500pcs	39269099		10bx	9196
712-084	1.9ml Clear, Gamma Sterile,500pcs	39269099		10bx	10285

Leak Proof | Made from High Quality PP | Withstands autoclaving and freezing | Made from High Quality PP Material | Consistent Wall thickness | Frosted writing area | Secure Cap & leak Proof Design | Easy One hand operation | Certified Dnase/Rnase Free | Gamma Sterile |

MICRO CENTRIFUGE TUBE (AMBER)



MICRO CENTRIFUGE TUBE (AMBER)

Cat. No.	Capacity	HSN	GST %	Packing	Price
712-083A	1.5ml, 500pcs	39269099	18	4 bx	2600
712-083g	1.5ml, Gamma Sterile,500pcs	39269099	18	4bx	3380

Leak Proof | Made from High Quality PP | Withstands autoclaving and freezing | Made from High Quality PP Material | Amber Colour | Consistent Wall thickness | Frosted writing area | Secure Cap & leak Proof Design | Easy One hand operation | Certified Dnase/Rnase Free | Available Gamma Sterile |

PESTLE

Specimen tubes are made from high quality virgin polypropylene. These Versatile tubes are used for storage and collection of a wide range of specimens and is capable to withstand freezing and autoclaving.



PESTLE

Cat. No.	Capacity	HSN	GST %	Price/Pack
712-083A	Pestle 10pcs/pk	3926 9099	18	650

SPECIMAN TUBES

Specimen tubes are made from high quality virgin polypropylene. These Versatile tubes are used for storage and collection of a wide range of specimens and is capable to withstand freezing and autoclaving.

SPECIMAN TUBE (FLAT BOTTOM)

Cat. No.	Capacity	HSN	GST %	Packing	Price/Pack
712-535	25ml	39269099		500	7020
712-536	25ml, ETO Sterile	39269099		500	8125
712-537	25ml, Gamma Sterile	39269099		500	8840

STORAGE VIALS



Storage vials are made of high-quality virgin polypropylene and is capable to withstand freezing and autoclaving, silicon ring cap design,

STORAGE VIALS

Cat. No.	Capacity	HSN	GST%	PACK	Price
712-087	1.8ml	39233090		2000	7300
712-088	1.8ml Gamma Sterile	39233090		2000	8720
712-089	5ml	39233090		1000	5600
712-090	5ml Gamma Sterile	39233090		1000	6395

SERUM AND SAMPLE CRYOGENIC TUBES

Serum and sample tubes proves to be excellent while handling & processing small volume of samples. These tubes are build from high quality PP and have silicon ring in cap which ensures leak proof operation.



SERUM & SAMPLE CRYOGENIC TUBES					
Cat. No.	Capacity	HSN	GST%	Packing	Price/Pack
712-096	SER.& SAM. CRYO TUBE 0.5ml	39233090		1000Pcs	7450
712-097	SER.& SAM. CRYO TUBE 0.5ml Gamma Sterile	39233090		1000Pcs	7950
712-098	SER.& SAM. CRYO TUBE 1.0ml	39233090		1000Pcs	7450
712-099	SER.& SAM. CRYO TUBE 1.0ml Gamma Sterile	39233090		1000Pcs	7950
712-100	SER.& SAM. CRYO TUBE 1.5ml	39233090		1000Pcs	7450
712-101	SER.& SAM. CRYO TUBE 1.5ml Gamma Sterile	39233090		1000Pcs	7950

SEROLOGICAL PIPETTES



Serological Pipettes are manufactured exclusively with high-grade polystyrene (GPPS) which ensures excellent clarity. The filter prevents overfilling and are suitable with all brands of pipetting apparatus. Precise, Bold & Black Graduations with clear scale ensure accuracy.

SEROLOGICAL PIPETTES					
Cat. No.	Description	HSN	GST	Pack	Price/Pk
712-209	Serological Pipette 1ml, Sterile	39269099		1000	13125
712-210	Serological Pipette 5ml, Sterile	39269099		300	6063
712-211	Serological Pipette 10ml, Sterile	39269099		200	4563
712-212	Serological Pipette 25ml, Sterile	39269099		200	8750
712-213	Serological Pipette 50ml, Sterile	39269099		100	12500

PIPETTE FILLER

SciBio pipette controller is an alternative to rubber pipette bulbs & other manual aspiration devices. It provides precise one-hand operation & an excellent tool for pipetting. It is compatible with 1 to 100ml serological volumetric & graduated pipettes. The 3um filter prevents cross-contamination and protects against over aspiration.



PIPETTE FILLER					
Cat. No.	Capacity (ml)	HSN	GST%	PACKING	PRICE
712-214	Pipette Controller 1-100ml	84798999		1	5500

PASTEUR PIPETTES

Pasteur pipette are made of PE – LD & are perfect products for transfer of fluid in a quick.



PASTEUR PIPETTES

Cat. #	Capacity	HSN	GST%	Pack	Price/Pk
712-215	1ml, Non Sterile	39269099		500 x 10/ pack	7313
712-216	1ml, Bulk Gamma Sterile	39269099			10000
712-217	3ml, Non Sterile	39269099			7313
712-218	3ml, Bulk Gamma Sterile	39269099			10000

VACUM FILTRATION APPARATUS

Vacuum filtration apparatus are useful to purify large volume samples efficiently in easy and fast manner. The filters are ultrasonically weld in the upper cup of apparatus and bottle has a wide mouth for efficient handling. Both Upper and lower cups have graduations.



VACUUM FILTRATION APPARATUS

Cat. No.	Membrane/ capacity	HSN	GST%	Price/Pack	Price/Pack
712-379	Nylon 1/pkg 150ml	8421 2900		0.45um	1188
712-380	Nylon 1/pkg 250ml	8421 2900		0.45um	1188
712-381	Nylon 1/pkg 500ml	8421 2900		0.45um	1438
712-382	PVDF 1/pkg 250ml	8421 2900		0.10um	1188
712-383	PVDF 1/pkg 250ml	8421 2900		0.22um	1188
712-384	PVDF 1/pkg 250ml	8421 2900		0.45um	1188

PLANT GROWTH REGULATOR



Plant Preservative Mixture (PPM), is a broad-spectrum biocide/fungicide for plant tissue culture. PPM™ is the ultimate solution to the never-ending struggle against microbial airborne, waterborne and endogenous contamination.

Plant Preservation Mixture (PPM™) is a robust broad-spectrum biocide formulated for use in plant tissue culture. PPM™ targets bacteria and fungi in plant tissue culture growth media as well as contaminated tissue. It affects key enzymes in the Krebs cycle and in the Electron Transport Chain. Depending on the dose and the level of contamination, PPM is a biocidal component in plant culture medium. In addition, it may also function as a biostatic compound as a preventative measure. When diluted with plant growth media it is effective as a microbiocide (i.e. bactericide and

fungicide) against non-human health pathogenic organisms component of liquid or semi-solid plant culture media.

PPM™ is effective for most seed bearing plants - angiosperm, as well as gymnosperm- however, it is not recommended for use in ferns, mosses, algae and aquatic plants. Optimization may be required to maximize potency. While PPM is an excellent tool in the prevention and elimination of culture contamination it is not a substitute for aseptic laboratory techniques and appropriate air handling systems are recommended.

Physical Properties : Physical form: Solution/Appearance:Clear,colorless to amber/pH: 3.8

Plant Preservation/Tissue Culture					
Cat. No.	Description	HSN	GST%	PACKING	Price/Pack
PPM-PB-200	Plant Preservative Mixture 200ml			1	50895
PPM-PB-500	Plant Preservative Mixture 500ml			1	85785

SILWET / VAC IN STUFF

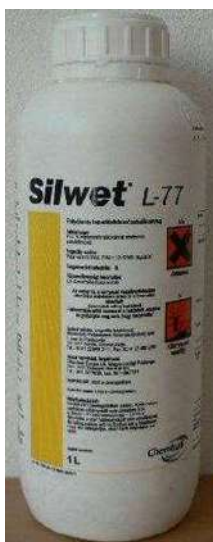

LEHLE SEEDS SILWET L77

Silwet L-77 (silicone-polyether copolymer) Economy Size. Vac-In-Stuff is a chemical mixture of polyalkyleneoxide modified heptamethyltrisiloxane (84%) and allyloxypolyethyleneglycol methyl ether (16%).

Silwet L 77 / Vac in Stuff					
Cat. No	Description	HSN	GST%	PACK	Price
PBS-5ml	L-77 Silwet spreader 10ml			1	10456
PBS-50ml	L-77 Silwet spreader 50ml			1	34895
PBS-500ml	L-77 Silwet spreader 500ml			1	60856

BIO-SOIL / SOIL CONDITIONER

SOILRITE-MIX

Soilrite-mix is a mixture of horticulture grade expanded perlite, Irish Peat moss and exfoliated vermiculite in equal ratio i.e., 1/3:1/3:1/3.

As Soilrite-mix contains peat moss with Vermiculite, Peat moss serves to increase water- holding capacity of the mix and the proportion of peat is just right to provide the plant the correct air / water ratio.

FEATURES

- Improves aeration and drainage
- Moisture and nutrients made readily available to plants
- Sterile - weed and disease free
- Inorganic - does not deteriorate
- PH essentially neutral 5.5 to 6.5
- Insulator - reduces extreme soil temperature fluctuations

ADVANTAGES - SOILRITE-MIX

- Compost of material with known properties
- All ingredients are standardized after exhaustive trials
- Nutrients contents are specifically known
- Handling and mixing done mechanically



- PDrainage and aeration are standardized
- Perlite and vermiculite are manufactured in high temperature conditions, hence no separate sterilization required
- Disease free and increased land growth response
- Lightweight and easy to move containers

APPLICATIONS - SOILRITE-MIX

- Container growing
- Landscaping and interspaces
- Potted plants
- Plant Propagation
- Lawns / Turf conditioning
- Soil Conditioning
- Outdoor Gardening Plant Tissue cultures
- Seed germination Rooting cutting
- Golf Greens Roof Gardens

Soil Rite Soil Conditioner					
Cat. No	Description	HSN	GST%	PACKING	Price/PACK
SS-BS-05	BioSoil-SoilRite 5Kg			1	2000
SS-BS-10	BioSoil-SoilRite 10Kg			1	3500
SS-BS-25	BioSoil-SoilRite 25Kg			1	7400

LABORATORY IDENTIFICATION SYSTEM

QL-800 Label Printer

The QL-800 is the perfect choice for office workers who need a reliable and fast address label printer.



Quickly print labels from your PC or Mac with this high speed label printer. Thanks to the integrated P-touch Editor Lite label design software it is so easy to use - simply connect to your computer, click the icon to launch the software and design and print your labels. Or use the advanced P-touch Editor label design software to include barcodes, images, and other advanced functions.

You're also able to produce labels with both black and red print without the need of ink or toner - ideal to highlight important information on a label.

And the integrated cutter allows custom sized labels up to one metre in length when using one of the continuous label rolls.

Key Features

- USB connectivity for quick and easy set-up
 - Print labels up to 62mm wide from your PC or Mac
 - Built-in label editing software doesn't need installing.
- Simply click to run
- Print in black and red without needing ink or toner
 - Print on pre sized labels (for your laboratory plates, tubes, slides, address or shipping labels) or continuous rolls up to 62mm wide (for indoor/outdoor signage).

BMP™21-LAB Printer

The BMP®21-LAB Printer can take on a variety of labeling project in laboratory environments, from vials and tubes to general identification

Label Materials that Last

Ultra-thin Polyester (B-461)



- Ultra-thin label easily slides in and out of racks and centrifuges
- Ideal for tubes, vials and conicals
- Lasts in liquid nitrogen, autoclaves and hot water baths

Catalog #	Color	Width Inch (mm)	Length Ft (m)
M21-375-461	Black on White	0.375 (9.53)	21 ft (6.40 m)
M21-500-461	Black on White	0.500 (12.70)	21 ft (6.40 m)
M21-750-461	Black on White	0.750 (19.05)	21 ft (6.40 m)

Polypropylene Label (B-7425)



- Versatile, durable and economical
- Ideal for vials, tubes and other specimen containers
- Lasts in liquid nitrogen

Catalog #	Color	Width Inch (mm)	Length Ft (m)
M21-375-7425	Black on White	0.375 (9.53)	21 ft (6.40 m)
M21-500-7425	Black on White	0.500 (12.70)	21 ft (6.40 m)
M21-750-7425	Black on White	0.750 (19.05)	21 ft (6.40 m)

Chemical-resistant Polyester Label (B-488)



- Ideal for slides
- Lasts in freezers and autoclaves, and withstands DMSO, ethanol and short-term xylene exposure

Catalog #	Color	Width Inch (mm)	Length Ft (m)
M21-375-488	Black on White	0.375 (9.53)	21 ft (6.40 m)
M21-500-488	Black on White	0.500 (12.70)	21 ft (6.40 m)
M21-750-488	Black on White	0.750 (19.05)	21 ft (6.40 m)

Nylon Cloth Label (B-499)



- Easy-to-handle label for non-rigid and curved surfaces
- Ideal for bags, bottles and tubes
- Lasts in liquid nitrogen, freezers and autoclaves

Catalog #	Color	Width Inch (mm)	Length Ft (m)
M21-375-499	Black on White	0.375 (9.53)	16 ft (4.88 m)
M21-500-499	Black on White	0.500 (12.70)	16 ft (4.88 m)
M21-750-499	Black on White	0.750 (19.05)	16 ft (4.88 m)



Y3998490 MS3998490

Clear Polyester Material (B-430)



- For flat or large curved surfaces
- Ideal for general purpose bottles, flasks and dishes
- Lasts in freezers and autoclaves

Catalog #	Color	Width Inch (mm)	Length Ft (m)
M21-250-430	* Black on Clear	0.250 (6.35)	21 ft (6.40 m)
M21-250-430-WT-CL	* White on Clear	0.250 (6.35)	21 ft (6.40 m)
M21-375-430	Black on Clear	0.375 (9.53)	21 ft (6.40 m)
M21-375-430-WT-CL	White on Clear	0.375 (9.53)	21 ft (6.40 m)
M21-500-430	Black on Clear	0.500 (12.70)	21 ft (6.40 m)
M21-500-430-WT-CL	White on Clear	0.500 (12.70)	21 ft (6.40 m)
M21-750-430	Black on Clear	0.750 (19.05)	21 ft (6.40 m)
M21-750-430-WT-CL	White on Clear	0.750 (19.05)	21 ft (6.40 m)

* Cartridge is only compatible with the BMP®21-LAB printer.

Durable Vinyl Material (B-595)



- Ideal for equipment, shelves, cabinets and general facility ID
- Available in a variety of colors
- For uneven and rough surfaces

Catalog #	Color	Width Inch (mm)	Length Ft (m)
M21-250-595-WT	* Black on White	0.250 (6.35)	21 ft (6.40 m)
M21-375-595-WT	Black on White	0.375 (9.53)	21 ft (6.40 m)
M21-500-595-WT	Black on White	0.500 (12.70)	21 ft (6.40 m)
M21-750-595-WT	Black on White	0.750 (19.05)	21 ft (6.40 m)
M21-250-595-YL	* Black on Yellow	0.250 (6.35)	21 ft (6.40 m)
M21-375-595-YL	Black on Yellow	0.375 (9.53)	21 ft (6.40 m)
M21-500-595-YL	Black on Yellow	0.500 (12.70)	21 ft (6.40 m)
M21-750-595-YL	Black on Yellow	0.750 (19.05)	21 ft (6.40 m)
M21-375-595-OR	Black on Orange	0.375 (9.53)	21 ft (6.40 m)
M21-500-595-OR	Black on Orange	0.500 (12.70)	21 ft (6.40 m)
M21-750-595-OR	Black on Orange	0.750 (19.05)	21 ft (6.40 m)
M21-375-595-BK	White on Black	0.375 (9.53)	21 ft (6.40 m)
M21-500-595-BK	White on Black	0.500 (12.70)	21 ft (6.40 m)
M21-750-595-BK	White on Black	0.750 (19.05)	21 ft (6.40 m)
M21-375-595-RD	White on Red	0.375 (9.53)	21 ft (6.40 m)
M21-500-595-RD	White on Red	0.500 (12.70)	21 ft (6.40 m)
M21-750-595-RD	White on Red	0.750 (19.05)	21 ft (6.40 m)
M21-375-595-BL	White on Blue	0.375 (9.53)	21 ft (6.40 m)
M21-500-595-BL	White on Blue	0.500 (12.70)	21 ft (6.40 m)
M21-750-595-BL	White on Blue	0.750 (19.05)	21 ft (6.40 m)
M21-375-595-BR	White on Brown	0.375 (9.53)	21 ft (6.40 m)
M21-500-595-BR	White on Brown	0.500 (12.70)	21 ft (6.40 m)
M21-750-595-BR	White on Brown	0.750 (19.05)	21 ft (6.40 m)
M21-375-595-GN	White on Green	0.375 (9.53)	21 ft (6.40 m)
M21-500-595-GN	White on Green	0.500 (12.70)	21 ft (6.40 m)
M21-750-595-GN	White on Green	0.750 (19.05)	21 ft (6.40 m)
M21-375-595-PL	White on Purple	0.375 (9.53)	21 ft (6.40 m)
M21-500-595-PL	White on Purple	0.500 (12.70)	21 ft (6.40 m)
M21-750-595-PL	White on Purple	0.750 (19.05)	21 ft (6.40 m)
M21-375-595-GY	Black on Grey	0.375 (9.53)	21 ft (6.40 m)
M21-500-595-GY	Black on Grey	0.500 (12.70)	21 ft (6.40 m)
M21-750-595-GY	Black on Grey	0.750 (19.05)	21 ft (6.40 m)

* Cartridge is only compatible with the BMP®21-LAB printer.

- Handheld label printer creates multi-line labels for clear identification of laboratory equipment including slides, tubes, beakers, bottles and more
- Built-in label templates with mathematical symbols save you time and makes labeling easy and efficient

- On-board keyboard contains letters A to Z and numbers 0 to 9, and backlit LCD graphics display for easier labeling even in low-lit areas
- Prints in 6 different text sizes ranging from 6 point to 40 point in a single color
- Label materials for laboratory applications such as cryogenic vials and slides
- Greek symbols commonly used in the laboratory
- **Barcoding**
- Automated label function cuts the label according to the size of the vial
- Automated serialization.

When it comes to in-the-lab labeling, illegible or smeared writing is not an option. With the powerful and affordable BMP® 21-LAB printer on hand, you can rely on crisp, long-lasting identification. Once you experience the built-in symbols, durable labels and vial/tube auto-sizing capabilities of the BMP21-LAB printer, you'll never use a pen again.



Labels Tested for Labs

- Labels and inks built to withstand harsh lab environments, including autoclaves, freezers, liquid nitrogen, and isopropyl alcohol and methyl ethyl ketone chemicals
- Unlike handwritten identification, printed labels reduce errors with easy-to-read text that fits more information in a small space
- Labels engineered for the lab means you never lose your data due to a failed label
- Technical Data Sheets (TDS) available with the specific properties and test results of each material, available at BradyID.com/tech data

Convenient Printer Features

- Vial label shortcut key automatically cuts labels to fit to vial and tube sizes
- Greek symbols and time and date stamps for enhanced sample tracking
- Built-in serialization and bar code symbologies provide more information in a smaller footprint
- Drop-lock-and-print cartridges for quick printing with no setup required
- Easy to use and easy to train others to use
- Variety of power options (use AA batteries, rechargeable battery or AC power supply — all sold separately)

Easy to Own and Maintain

Label supplies and printer available through top lab distributors
Low price point allows each technician or lab station to have a printer.

BMP®21-LAB Printer						
Cat. No.	Description	HSN	GST%	PACKING	Price/Pack	
BMP21-LAB	BMP21-LAB Printer Blister Pack (Ships with:Printer + Lanyard + M21-750-7425 label cartridge)	84433290		1	35000	

BMP®21-LAB & Battery Pack Kit					
BMP21-LAB-KIT1	BMP21-LAB Printer Kit (Ships with: Printer + Li-ion Battery + Charger/ Power Cord + Lanyard+M21-750-7425 label) cartridge	84433290		1	45000
BMP71-LAB	BMP21-LAB Laboratory Labelling	84433290		1	85000
BMP71-LAB-L1	Labels for BMP71 * 1.8ml Vials + PCR Plates 1000 labels roll	84433290		1	4000
BMP71-LAB-C1	Ink Cartridges for BMP71 * 1.8ml Vials + PCR Plates 1000 labels roll	84433290		1	1500
QL-800 Label Printer with cartridge					
QL-800-ctrg	QL-800 Label Printer with cartridge Direct thermal printing via thermal head, Max. 150 mm/sec, Max. 93 labels/min. (Standard Address Labels) It will work form -80° up to +120° Liquid Nitrogen sustainability of labels. Application : Bottle / Beaker identification and any kind of sample vials 2 to 50ul. Test substance management (test tube, slide etc)	84433290		1	15000
DK-22205	Continuous roll 62mmx30.8 meters thermal paper roll, self adhesive, no need to add ink/cartridge.	84433290		1	2000
361075	BBP11-34L	84433290		1	79815
361069	BBP11-24L			1	64600
81029	LABPAL			1	35000
81030	PAL-375-461			1	4532
81013	PAL-375-499			1	2710
81031	PAL-375-488			1	3758
81010	PAL-375-423			1	3116
81011	PAL-375-430			1	3116
81012	PAL-375-439			1	2662
81032	PAL-500-461			1	4913
81017	PAL-500-499			1	2824
81033	PAL-500-488			1	4810
81014	PAL-500-423			1	3402
81015	PAL-500-430			1	3382
81016	PAL-500-439			1	2824
81034	PAL-750-461			1	6654
81021	PAL-750-499			1	3276
81035	PAL-750-488			1	5041
81018	PAL-750-423			1	3518
Cat. No.	Description	HSN	GST%	PACKING	Price/Pack
81019	PAL-750-430			1	3461
81020	PAL-750-439			1	3790

MINOR INSTRUMENTS

MICROPLATE SHAKER



- Mixing Motion : Orbital
- Orbit Diameter : 4.5mm
- Speed Range : 0-1500 Single Plate , 0-1000 Dual Plate
- Speed Display : Scale
- Sturdy and Compact Design
- Variable speed range upto 2500 RPM in Vortex Mixer
- Variable speed range upto 1500 RPM in Micro Plate Shaker
- Oil Less ball bearings ensures noise free operation and long

life

- Brushless DC Motor

Microplate Shaker

Cat No.	Description	HSN	GST%	Packing	Price
712-525	Microplate Shaker	84798200		1	33125
712-526	Accessories Dual Microplate Attachment	84798200		1	1563
712-527	Accessory Pack For All Tubes 0.2ml,0.5ml,1.5ml,2ml,15ml	84798200		1	5000

MULTITUBE VORTEX MIXER

- Timer Function
- Bright LED Display
- Short Mix / Continuous Operation
- Unique Design Offers Stability
- All Accessories Included



Vortex Mixer

Cat No.	Description	HSN	GST	Packing	Price
712-491	Touch fairy Vortexer	84798200		1	13750
712-492	Vortex Mixer Fixed Basic	84798200		1	11563
712-493	Vortex Mixer Adjustable Speed	84798200		1	15000
712-494	Accessories Tube Holding Rod	84798200		1	3500
712-495	Accessory Pack Any One (0.2ml, 0.5ml, 1.5ml/2ml, 15ml)	84798200		1	2438
712-496	Accessory Pack For All Tubes 0.2ml, 0.5ml, 1.5ml/2ml, 15ml	84798200		1	5000
712-497	Accessory Pack Flat Platform Pad with Universal Plate	84798200		1	1875
712-498	Multi Tube Vortex Mixer with Accessories	84798200		1	11875
712-499	Accessory Pack for Multi Tube Vortex Microtubes 1.5ml/2ml	84798200		1	3125
712-500	Accessory Pack for Multi Tube Vortex Microtubes 15ml	84798200		1	3125

712-501	Accessory Pack for Multi Tube Vortex Microtubes 50ml	84798200	1	3125
---------	--	----------	---	------

DRY BATH MINI



Mini Dry Bath
Smallest! Fits in the palm of your hand
Economically priced Easy to Use
Exchangeable blocks for tubes from 0.2 to 50ml
Digital temperature control improves temp. Uniformity
Used advanced thermoelectric technique Decent LCD Display with Simultaneous time and temp.
Beep Sound After program

MINI DRY BATH

Cat. No.	Description	HSN	GST%	Packing	Price
712-514	Mini Dry Bath(RT+5 C to 100)	8419 8990			30000
712-515	Mini Dry Bath(-10to100C)	8419 8990			74375
712-516	Block For Dry Bath 40x0.2ml	8419 8990			6125
712-517	Block For Dry Bath 24x0.5ml	8419 8990			6125
712-518	Block For Dry Bath 15x1.5ml/2ml	8419 8990			6125
712-519	Block For Dry Bath 4x15ml	8419 8990			6125
712-520	Block For Dry Bath 2x 50ml	8419 8990			6125

ORBITAL SHAKER



Orbital Shaker

Cat No.	Description	HSN	GST%	Packing	Price
712-502	Orbital Shaker 10mm	8479 8200		1	60000
712-503	Orbital Shaker 20mm	8479 8200		1	60000
712-504	Orbital Shaker 30mm	8479 8200		1	68750
712-505	Flat platform with non-slip rubber mat	8479 8200		1	3500
712-506	Universal platform with adjustable bars	8479 8200		1	15625
712-507	Platform with clamps for flasks 100-150ml	8479 8200		1	4750
712-508	Platform with clamps for flasks 250-300ml	8479 8200		1	5625

MAGNETIC STIRRER

- Sturdy and Compact Design
- Super Bright LED display
- Variable Speed upto 1500 RPM
- Plastic & Ceramic Coated surface are both highly chemical resistant
- Microprocessors ensures accurate temperature control



Magnetic Stirrer

Cat. No.	Description	HSN	GST	Packing	Price
712-460	FLAT SPIN Magnetic Stirrer	84798200		1	10875
712-461	Magnetic Stirrer, Plastic Top	84798200		1	11250
712-462	Magnetic Stirrer LED , Plastic Top	84798200		1	13750
712-463	Magnetic Stirrer + Hot Plate, Ceramic Top	84798200		1	24375
712-464	Magnetic Stirrer 7 Inch Square + Hot Plate, Ceramic Top	84798200		1	46875
712-465	Stirring bars Assorted Pack	85051190		1	1250
712-466	10x6(2Pcs.),15x8 (2Pcs.),25x8(2Pcs.), 40x8 (1Pcs.)	85051190		1	2580
712-467	Stirring Bar Mover	85051190		1	3313

MICRO CENTRIFUGE



- Ideal For Quick Spin-downs
- Easy To use
- New Clip-On Designed Rotor
- Bright LED Display
- Noise Free Operation
- Sturdy Compact Design
- Maintenance Free Motor
- Large Rotor (helps achieving better Centrifugal force)

Mini Centrifuge

Cat No.	Description	HSN	GST	Packing	Price
712-488	Mini Centrifuge, Fixed Speed	84211910		1	11563
712-489	Mini Centrifuge, Variable Speed	84211910		1	29375
712-490	Plus High Speed Mini Centrifuge	84211910		1	75000

ELECTROPHORESIS SYSTEMS-HORIZONTAL

*StarPhoresis Mini and Wide Mini Gel
Horizontal Systems*

Mini Horizontal Gel System,
Cat. No. N2007-0810

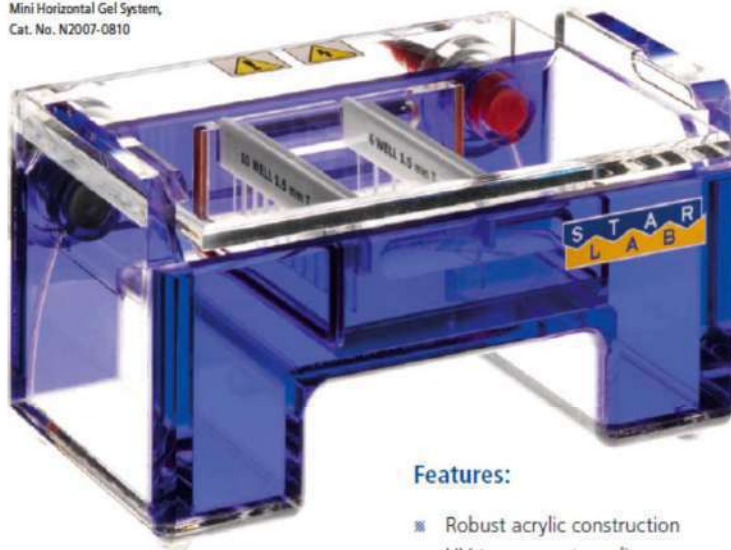

StarPhoresis

Features:

- ❖ Robust acrylic construction
- ❖ UV-transparent acrylic
- ❖ Safety lid
- ❖ Gasketed gel tray
- ❖ Various comb slot configurations
- ❖ Optional casting accessories
- ❖ 36-month warranty

Small and quick!

STARLAB's new StarPhoresis Mini Gel Systems offer a range of commonly used Mini Gel and Wide Mini Gel formats for the quick separation and analysis of nucleic acids on smaller agarose gels. The units are equipped with a safety lid and gasketed gel trays for direct casting of gels in the tray (except N2014-1010).

Combs are available in 1.0 mm and 1.5 mm thicknesses, in a microtitre format, and in a variety of tooth configurations to accommodate a variety of sample quantity and volume.

A range of casting accessories make these units suitable for all research laboratories and the high quality acrylic construction will withstand daily use without breakage, warping or leakage.

Specification for StarPhoresis Mini Gel Horizontal Systems

Cat. No.	Product Description	Comb Specification	Gel Dimensions	System Dimensions (L x W x H)	Maximum Voltage	Maximum Sample Capacity	Max. Samples, Full Length	Max. Buffer Volume
N2007-0810	Mini Horizontal 7 x 8 cm Gel System, incl. Gel Tray with 2 Comb Slots, 2 Combs	1.5 mm thickness, 6 and 10 teeth	7 x 8 cm	17.6 x 12 x 9.5 cm	150 V	24	12	400 ml
N2009-1110	Mini Horizontal 9 x 11 cm Gel System, incl. Gel Tray with 2 Comb Slots, 2 Combs	1.5 mm thickness, 10 and 14 teeth	9 x 11 cm	22 x 15 x 9.5 cm	150 V	28	14	600 ml
N2012-1410	Mini Horizontal 12 x 14 cm Gel System, incl. Gel Tray with 4 Comb Slots, 2 Combs	1.5 mm thickness, 12 and 20 teeth	12 x 14 cm	24.5 x 18 x 9.5 cm	150 V	100	25	800 ml

Specification for StarPhoresis Wide Mini Gel Horizontal Systems

Cat. No.	Product Description	Comb Specification	Gel Dimensions	System Dimensions (L x W x H)	Maximum Voltage	Maximum Sample Capacity	Max. Samples, Full Length	Max. Buffer Volume
N2014-1010	Wide Mini Horizontal 14.4 x 10.2 cm Gel System, incl. Gel Tray with 2 Comb Slots, 4 Combs, external Gel Caster	1.5 mm thickness, 2 x 30 and 2 x 40 teeth	14.4 x 10.2 cm	17 x 17 x 10 cm	150 V	80	40	600 ml
N2023-1410	Wide Mini Horizontal 23.5 x 14 cm Gel System, incl. Gel Tray with 4 Comb Slots, 4 Combs	1.5 mm thickness, 4 x 50 teeth	23.5 x 14 cm	29 x 26 x 10 cm	150 V	200	50	1000 ml

StarPhoresis Long and Wide Long Gel Horizontal Systems

More separations!

StarPhoresis Long and Wide Long Gel Horizontal Systems are ideally suited for the analysis of up to 600 sample sets of DNA and RNA. The longer gel trays separate samples containing a large number of fragments with a high resolution. The systems' robust, high quality acrylic construction will withstand daily use without breakage, warping or leakage. All units are equipped with a safety lid and a three-point leveling base for obtaining consistent reproducible results. Agarose gel can be cast directly in the gasketed gel tray without the use of tape.

The combs are available in 1.0 mm and 1.5 mm thicknesses, in a micotitre format, and in a variety of tooth configurations to accommodate a wide range of sample quantities and volumes.

Wide Long Horizontal Gel System,
Cat. No. N2120-2510

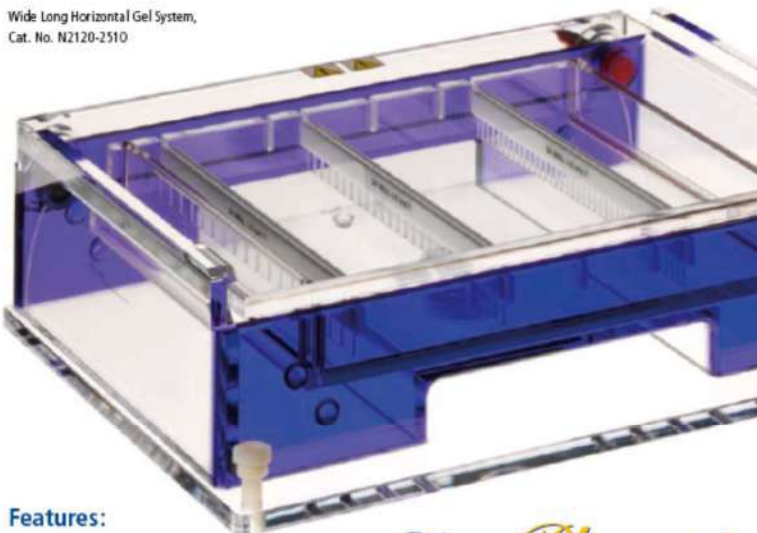

Features:

- Robust acrylic construction
- UV-transparent acrylic
- Safety lid
- Three-point leveling base
- Gel trays with gasketed endgates
- Allows a high number of samples and a higher resolution
- Various comb slot configurations
- 36-month warranty

StarPhoresis

Specification for StarPhoresis Long and Wide Long Gel Horizontal Systems								
Cat. No.	Product Description	Comb Specification	Gel Size (W x L)	System Dimensions (L x W x H)	Maximum Voltage	Max. Sample Capacity	Max. Samples, Full Length	Max. Buffer Volume
Long Horizontal								
N2113-2510	Long Horizontal 13 x 25 cm Gel System, incl. 3 Point leveling base, Gel Tray with 6 Comb Slots, 3 Combs	1.5 mm thickness, 12, 16 and 20 teeth	13 x 25 cm	37.5 x 21.5 x 10.5 cm	200 V	112	28	1600 ml
N2120-2510	Long Horizontal 20 x 25 cm Gel System, incl. 3 Point leveling base, Gel Tray with 6 Comb Slots, 3 Combs	1.5 mm thickness, 16, 24 and 36 teeth	20 x 25 cm	37.5 x 29 x 10.5 cm	200 V	168	42	2300 ml
Wide Long Horizontal								
N2123-2510	Wide Long Horizontal 23.5 x 25 cm Gel System, incl. 3 Point leveling base, Gel Tray with 14 Comb Slots, 4 Combs	1.5 mm thickness, 2 x 25 and 2 x 50 teeth	23.5 x 25 cm	37.5 x 32 x 10.5 cm	200 V	500	50	3000 ml
N2123-4010	Wide Long Horizontal 23.5 x 40 cm Gel System, incl. 3 Point leveling base, Gel Tray with 12 Comb Slots, 4 Combs	1.5 mm thickness, 2 x 25 and 2 x 50 teeth	23.5 x 40 cm	53 x 32 x 10.5 cm	200 V	600	50	4500 ml

ELECTROPHORESIS SYSTEMS-VERTICAL

ELECTROPHORESIS

StarPhoresis 2-Gel Mini and 2-Gel Wide Mini Vertical Systems



2-Gel Mini
10 x 10 cm Vertical System,
Cat. No. N2510-1010

Highest resolution!

The Polyacrylamide Gel Electrophoresis (PAGE) is a frequently used method for identifying and quantifying protein and nucleic acid fragments in Biotech laboratories. To achieve high resolution PAGE separations STARLAB offers the StarPhoresis 2-Gel Mini Vertical Systems to help simplify the routine in laboratories. Manufactured to an "intelligent design" StarPhoresis Vertical Systems guarantee easy handling without breakage, warping or leakage. The integrated efficient water cooling system avoids smiling effects of the dye front.

Combs are available in thicknesses of 0.8 mm and 1.5 mm and in a variety of tooth combinations. Four unit sizes are available, all equipped with a special safety lid.

Features:

- Water cooling system
- Parallel gel runs
- High resolution
- Robust acrylic construction
- Intelligent design
- Safety lid
- Integrated casting base
- Various comb slot configurations
- 36-month warranty

StarPhoresis

Specification for StarPhoresis 2-Gel Mini and 2-Gel Wide Mini Vertical Systems

Cat. No.	Product Description	Comb Specification	Spacer	Gel Size (W x L)	Maximum Voltage	Current (mAmps), Constant	Maximum Sample Capacity	Upper Buffer Chamber Capacity	Lower Buffer Chamber Capacity
Mini Vertical									
N2510-1010	2-Gel Mini 10 x 10 cm Vertical System, "Water Cooled", incl. Casting Base, 2 Combs, 4 Side Spacers, 4 Sets of Glass (4 each notched & blank), Blocking Plate, Replacement Gaskets for Upper Buffer Chamber and Casting Base, 2 Spring Pegs	0.8 mm thickness, 2 x 10 teeth	4 Side Spacer, 0.8 mm thickness	10 x 10 cm	600 V	15-35 mA/Gel	24	170 ml	240 ml
N2516-1410	2-Gel Mini 16 x 14 cm Vertical System, "Water Cooled", incl. Casting Base, 4 Combs, 8 Side Spacers, 4 Sets of Glass (4 each notched & blank), Blocking Plate, Replacement Gaskets for Upper Buffer Chamber and Casting Base, 2 Spring Pegs	1.5 mm thickness, 2 x 10 and 2 x 15 teeth	8 Side Spacer, 1.5 mm thickness	16 x 14 cm	600 V	15-50 mA/Gel	48	400 ml	300 ml
N2520-2010	2-Gel Mini 20 x 20 cm Vertical System, "Water Cooled", incl. Casting Base, 4 Combs, 8 Side Spacers, 4 Sets of Glass (4 each notched & blank), Blocking Plate, Replacement Gaskets for Upper Buffer Chamber and Casting Base, 2 Spring Pegs	1.5 mm thickness, 2 x 15 and 2 x 20 teeth	8 Side Spacer, 1.5 mm thickness	20 x 20 cm	600 V	15-75 mA/Gel	50	600 ml	800 ml
Wide Mini Vertical									
N2520-1010	2-Gel Wide Mini 20 x 10 cm Vertical System, "Water Cooled", incl. Casting Base, 4 Combs, 8 Side Spacers, 4 Sets of Glass (4 each notched & blank), Blocking Plate, Replacement Gaskets for Upper Buffer Chamber and Casting Base, 2 Spring Pegs	0.8 mm thickness, 2 x 15 and 2 x 20 teeth	4 Side Spacer, 0.8 mm thickness	20 x 10 cm	600 V	30-45 mA/Gel	72	400 ml	450 ml

BLOTTING SYSTEMS (SEMI DRY ELECTROBLOTTERS)

STARLAB Semi-Dry Electro-Blotters

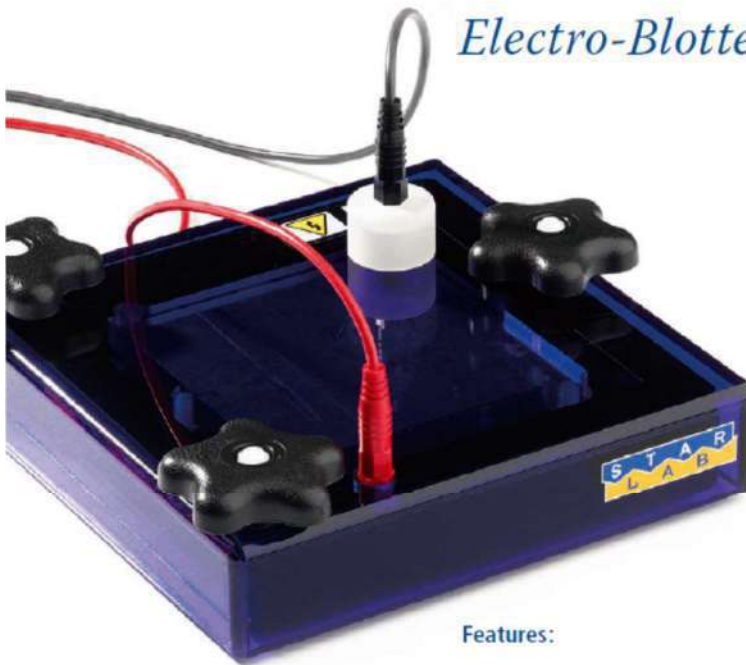

Semi-Dry Electro-Blotter Mini 10 x 10cm, Cat. No. N2011-1110

Features:

- Platinised titanium and stainless steel plate electrodes
- Large surface area
- Highly efficient transfer of fragments
- Corrosion-free gold-plated plugs
- Safety cover
- Robust acrylic construction
- 36-month warranty

Blotting that works!

Southern, Northern and Western Blotting are common techniques used for the transfer of nucleic acid and protein fragments from polyacrylamide or agarose gels to blotting membranes such as nitrocellulose, nylon or PVDF membranes.

STARLAB's Semi-Dry Electro-Blotters have a large surface area of plate electrodes to enable rapid and highly efficient transfer in conjunction with high signal strength. The highly conductive platinised titanium and stainless steel plate electrodes allow transfer at low voltages without the use of external cooling systems.

STARLAB Electro-Blotters consume significantly less transfer buffer without a loss in transfer efficiency or signal strength. A safety cover prevents the reverse orientation of electric fields, and the robust acrylic construction guarantees easy handling without breakage, warping or leakage.

Specification for StarLab Semi-dry Electro Blotters				
Cat. No.	Product Description	Gel Size (W x L)	Power Settings	Suggested Power Supplies
Mini Format				
N2011-1110	STARLAB Semi-Dry Electro-Blotter Mini 10 x 10 cm, complete system includes base and cover with planar electrodes, assembly knobs and attached power cords	10 x 10 cm	Protein: Constant current 0.8–3 mA per cm ² gel surface area, 10–14 V maximum DNA/RNA: Constant current 0.5–3 mA per cm ² gel surface area, 10–14 V maximum	STARLAB Power Supply with 300 V/400 mA/120 W or STARLAB Power Supply with 300 V/500 mA/150 W
Maxi Format				
N2021-2110	STARLAB Semi-Dry Electro-Blotter Maxi 20 x 20 cm, complete system includes base and cover with planar electrodes, assembly knobs and attached power cords	20 x 20 cm	Protein: Constant current 0.8–3 mA per cm ² gel surface area, 10–14 V maximum DNA/RNA: Constant current 0.5–3 mA per cm ² gel surface area, 10–14 V maximum	STARLAB Power Supply with 600 V/800 mA/300 W

POWER SUPPLIES

STARLAB Power Supplies



Features:

- 300–1000 Volt range to accommodate many applications
- Constant voltage
- Constant power
- LED display
- Tactile membrane panels
- Automatic restart in case of power failure

High Voltage!

Results of electrophoresis and electroblotting techniques depend not only on the primary equipment but also on reliable power supplies.

Adjusted to specific requirements of different separating and transferring applications, STARLAB power supplies are available in ranges from 300 V/400 mA up to 1000 V/600 mA. They are designed according to international and CE European guidelines to guarantee the highest quality and safety.

The last setting is automatically restored at power up and the timer function (except Type 300-400) also allows user friendly analysis runs. A further feature is a tactile membrane panel for precise input of parameters.

STARLAB power supplies have LED displays to indicate voltage and current (a display indicates time on some models), and they also have automatic restart in the case of power failure, making them the first choice for your laboratory.

Specification for StartLab Power Supplies

Cat. No.	Product Description	Maximum Voltage	Maximum Current	Maximum Power	Dimensions (W x D x H)	Minimum regulated value	Fault detection	Gel Saver*	Operating temperature	Weight
N2000-3040	STARLAB Power Supply 300-400	300 V	400 mA	120 W	17 x 24 x 7 cm	1 V/1 mA	Stop	–	0°C–40 °C	1.6 kg
N2000-3050	STARLAB Power Supply 300-500	300 V	500 mA	150 W	17 x 24 x 7 cm	1 V/1 mA	Stop and audible alarm	✓	0°C–40 °C	1.6 kg
N2000-5030	STARLAB Power Supply 500-300	500 V	300 mA	150 W	17 x 24 x 7 cm	1 V/1 mA	Stop and audible alarm	✓	0°C–40 °C	1.6 kg
N2000-6080	STARLAB Power Supply 600-800	600 V	800 mA	300 W	27 x 34 x 11 cm	5 V/1 mA	Stop and audible alarm	–	0°C–40 °C	4 kg
N2000-1060	STARLAB Power Supply 1000-600	1000 V	600 mA	300 W	27 x 34 x 11 cm	10 V/1 mA	Stop and audible alarm	–	0°C–40 °C	4 kg

*Gel Saver (300-500 and 500-300 supplies only): In case of the timer indicating the end of an electrophoresis application, the gel saver function avoids diffusion of bands.

Applications for StartLab Power Supplies

Product Description	DNA/RNA, agarose gel	RFLP and DNA Fragments	PCR-Screening	Protein Electrophoresis	Preparative Gels/ SDS-Page	Semi-dry Blotting	Western Blotting
STARLAB Power Supply 300-400	**	**	**	**	**	*	**
STARLAB Power Supply 300-500	**	**	**	**	**	**	**
STARLAB Power Supply 500-300	**	**	**	**	**	*	–
STARLAB Power Supply 600-800	**	**	**	**	**	**	**
STARLAB Power Supply 1000-600	*	*	*	**	**	*	*

** recommended * use possible

AGAROSE FOR ELECTROPHORESIS

StarPure Agarose

Product Overview

Agarose is a neutral polysaccharide extracted from the cell walls of certain Rhodophyceae algae also known as agarophyte seaweeds.

The molecular structure of this polysaccharide gives the capacity to form gels that are very strong even at low concentrations.

StarPure Agaroses are reliably high quality products for Gel Electrophoresis in Biotech laboratories.

They can be used with, but are not limited to, StarPhoresis Electrophoresis Systems. Six StarPure grades will cover the most common applications in biotech labs.



StarPure Agarose
CAS: 9012-36-6 EC: 2327318
For laboratory use only.
Store at room temperature.

StarPure Grades

- ✦ Low EEO Standard
- ✦ Low EEO Standard GQT
- ✦ Low Melt
- ✦ Low Melt Sieve GQT
- ✦ High Resolution
- ✦ High Resolution 3:1

StarPure Agarose for Horizontal Electrophoresis		
Cat. No.	Product Description	Pack Size
N3101-0100	StarPure Low EEO Standard Agarose, > 1 kb	100 g
N3101-0500	StarPure Low EEO Standard Agarose, > 1 kb	500 g
N3102-0100	StarPure Low EEO Standard Agarose, > 1 kb, GQT	100 g
N3102-0500	StarPure Low EEO Standard Agarose, > 1 kb, GQT	500 g
N3103-0100	StarPure Low Melt Agarose, > 1kb	100 g
N3104-0100	StarPure Low Melt Sieve Agarose, < 1000 bp, GQT	100 g
N3104-0500	StarPure Low Melt Sieve Agarose, < 1000 bp, GQT	500 g
N3105-0100	StarPure High Resolution Agarose, 10–1200 bp	100 g
N3105-0500	StarPure High Resolution Agarose, 10–1200 bp	500 g
N3106-0100	StarPure High Resolution 3:1 Agarose, 150–1500 bp	100 g

StarPure Application Information								
	Analytical Separation > 1000 bp	Analytical Separation < 1000 bp	Preparative Electrophoresis	DNA Typing	Blotting	High Resolution	In-Gel Applications	Protein Electrophoresis
Low EEO Standard Agarose, > 1 kb	✓			✓	✓			
Low EEO Standard Agarose, > 1 kb, GQT	✓		✓	✓	✓			
Low Melt Agarose, > 1 kb	✓							
Low Melt Sieve Agarose, < 1000 bp, GQT		✓	✓			✓	✓	
High Resolution Agarose, 10–1200 bp		✓				✓		✓
High Resolution 3:1 Agarose, 150–1500 bp		✓			✓	✓		

StarPure Agarose Grades

Low EEO

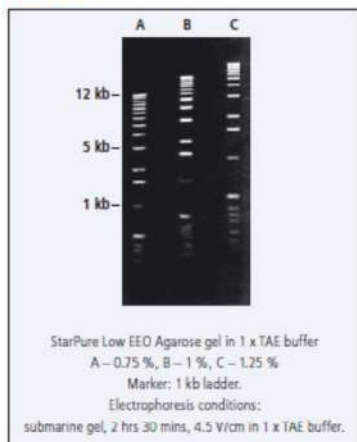

Features:

- For DNA/RNA separation >1 kb
- Low EEO for high electrophoresis mobility
- Extraordinary mechanical resistance for reliable and easier handling
- Excellent transparency of the gel
- Very low absorption of staining agents
- Greater thermal stability due to hysteresis (difference between gelling and melting temperature)

Low Melt

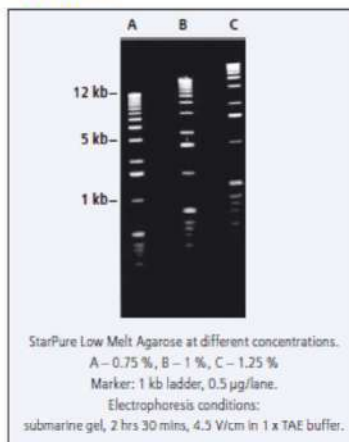

Features:

- For DNA/RNA separation > 1 kb
- Lower melting and gelling temperatures than standard agaroses
- Recovery of larger DNA fragments below the denaturation temperature
- Higher clarity than gels of standard agarose
- Greater sieving capacity

High Resolution

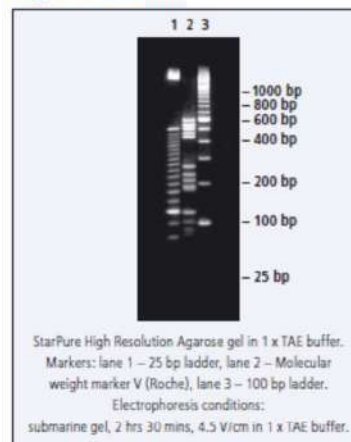

Features:

- Highest DNA/RNA separation from 10–1200 bp close to the resolution of PAGE
- Specially formulated for molecular screening
- Improved clarity of the gel, even at high concentrations
- High gel strength enables easy handling

Low Melt Sieve

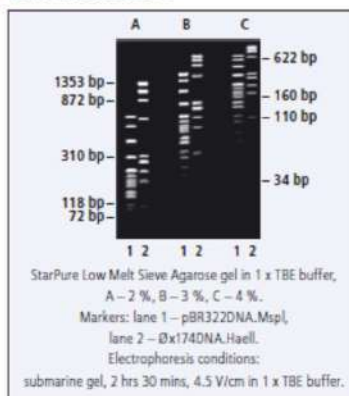

Features:

- For DNA/RNA separation < 1000 bp
- High resolving capacity for small DNA fragments
- Lower melting and gelling temperatures than standard agaroses
- Recovery of smaller DNA fragments below the denaturation temperature
- For In-Gel enzymatic processing
- For preparative Electrophoresis

High Resolution 3:1

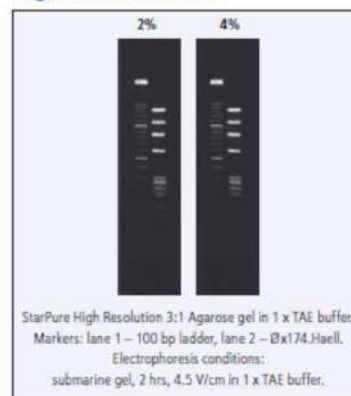

Features:

- High DNA/RNA separation from 10–1200 bp
- Strong and flexible Gels especially for Blotting procedures
- Low viscosity allows preparation of high gel concentrations

GQT

GQT (Genetic Quality Tested) is a synonym for an agarose quality especially made for In-Gel applications. The agarose is free of disturbing contaminants and allows a direct analysis procedure in remelted agarose.

GQT also ensures that preparative Electrophoresis can be performed and DNA recovered without damaging its properties and structure.

Electrophoresis System, Power Supply, Electro-Blotting System, Agarose

Cat. No.	Description	HSN	GST%	Pack	Price
N3101-0100	STARLAB Low EEO Standard Agarose, > 1Kb	13021915		1	7776
N3101-0500	STARLAB Low EEO Standard Agarose, > 1Kb	13021915		1	36258
N3102-0100	STARLAB Low EEO Standard Agarose, > 1Kb, GQT tested	13021915		1	8672
N3102-0500	STARLAB Low EEO Standard Agarose, > 1Kb, GQT tested	13021915		1	40745
N3103-0100	STARLAB Low Melt Agarose, >1 Kb	13021915		1	35955
N3104-0100	STARLAB Low Melt Sieve Agarose, < 1000 bp, GQT tested	13021915		1	37152
N3104-0500	STARLAB Low Melt Sieve Agarose, < 1000 bp, GQT tested	13021915		1	183168
N3105-0100	STARLAB High Resolution Agarose,10-1200 bp	13021915		1	27406
N3105-0500	STARLAB High Resolution Agarose, 10-1200 bp	13021915		1	134451
N3106-0500	STARLAB High Resolution 3:1 Agarose, 150-1500 bp	13021915		1	27861
N2000-1060	STARLAB Power supply 1000-600	85044090		1	206848
N2000-3040	STARLAB Power supply 300-400	85044090		1	76512
N2000-3050	STARLAB Power supply 300-500	85044090		1	92346
N2000-5030	STARLAB Power supply 500-300	85044090		1	92346
N2000-6080	STARLAB Power supply 600-800	85044090		1	190227
N2007-0810	STARLAB Mini Horizontal 7 x 8cm Gel System, incl. Gel Tray with 2 Comb Slots, 2 Combs	90278090		1	40777
N2009-1110	STARLAB Mini Horizontal 9 x 11cm Gel System, incl. Gel Tray with 2 Comb Slots, 2 Combs	90278090		1	45500
N2011-1110	STARLAB Semi-dry Electro-Blotter Mini 10 x 10cm, complete System includes base and cover with planar electrodes, assembly knobs and attached power cords	90278090		1	94294
N2012-1410	STARLAB Mini Horizontal 12 x 14cm Gel System, incl. Gel Tray with 4 Comb Slots, 2 Combs	90278090		1	53369
N2014-1010	STARLAB Wide Mini Horizontal 14.4 x 10.2cm Gel System, incl. Gel Tray with 2 Comb Slots, Gel Caster, 4 Combs	90278090		1	61240
N2021-2110	STARLAB Semi-dry Electro-Blotter Maxi 20 x 20cm, complete System includes base and cover with planar electrodes, assembly knobs and attached power cords	90278090		1	125773
N2023-1410	STARLAB Wide Mini Horizontal 23.5 x 14cm Gel System, incl. Gel Tray with 4 Comb Slots, Gel Caster, 4 Combs	90278090		1	78554
N2113-2510	STARLAB Long Horizontal 13 x 25cm Gel System, incl. 3 Point leveling base, Gel Tray with 6 Comb Slots, 3 Combs	90278090		1	70683

Cat. No.	Description	HSN	GST%	Pack	Price
N2120-2510	STARLAB Long Horizontal 20 x 25cm Gel System, incl. 3 Point leveling base, Gel Tray with 6 Comb Slots, 3 Combs	90278090		1	80287
N2123-2510	STARLAB Wide Long Horizontal 23.5 x 25cm Gel System, incl. 3 Point leveling base, Gel Tray with 14 Comb Slots, 4 Combs	90278090		1	86584
N2123-4010	STARLAB Wide Long Horizontal 23.5 x 40cm Gel System, incl. 3 Point leveling base, Gel Tray with 12 Comb Slots, 4 Combs	90278090		1	94294
N2510-1010	STARLAB 2-Gel Mini 10 x 10cm Vertical System, "Water Cooled", incl. Casting Base, 2 Combs, 4 Side Spacers, 4 Sets of Glass (4 each notched & blank), Blocking Plate, Replacement Gaskets for Upper Buffer Chamber and Casting Base, 2 Spring Pegs	90278090		1	90519
N2516-1410	STARLAB 2-Gel Mini 16 x 14cm Vertical System, "Water Cooled", incl. Casting Base, 4 Combs, 8 Side Spacers, 4 Sets of Glass (4 each notched & blank), Blocking Plate, Replacement Gaskets for Upper Buffer Chamber and Casting Base, 2 Spring Pegs	90278090		1	137738
N2520-1010	STARLAB 2-Gel Wide Mini 20 x 10cm Vertical System, "Water Cooled", incl. Casting Base, 4 Combs, 8 Side Spacers, 4 Sets of Glass (4 each notched & blank), Blocking Plate, Replacement Gaskets for Upper Buffer Chamber and Casting Base, 2 Spring Pegs	90278090		1	121998
N2520-2010	STARLAB 2-Gel Mini 20 x 20cm Vertical System, "Water Cooled", incl. Casting Base, 4 Combs, 8 Side Spacers, 4 Sets of Glass (4 each notched & blank), Blocking Plate, Replacement Gaskets for Upper Buffer Chamber and Casting Base, 2 Spring Pegs	90278090		1	153478

X-TRACTA GEL EXTRACTION TOOL

- High accuracy and precision
- Rapid, four-step process
- One-handed operation
- No risk for cross-contamination
- Easy to use
- High yield recovery
- Low failure rate



X-tracta Gel Extraction Tool

Cat. No.	Description	HSN	GST%	Price
N2000-0025	X-tracta disposable gel extraction tool 25/pk		18	3,761
N2000-0100	X-tracta disposable gel extraction tool 100/pk		18	12,021

GERMINATION PAPER

Germination Paper is made of brown color good quality absorbent paper with creping for seed germination testing. Seed Germination Paper is available in standard size of 45x28cm or 18"x12" in packing of 25 Kg per bundle. The specifications are as follows:



S. No.	Specification	Value
1.	Basic Weight	125 gm/m ²
2.	Bursting Strength	25 kg/m ²
3.	Capillary Rise	38 mm/minute
4.	pH Value	7.0
5.	Ash % (max)	0.49

Germination Paper

Cat. No.	Description	HSN	GST%	Price
812-001	45x28 cm Special Quality (kg)		18%	325
812-002	45x28 cm Imported Quality (kg)		18%	425
812-003	45x28cm Ordinary Quality (kg)		18%	315
812-004	45x28cm Ordinary Quality (ream) white		18%	3000

MANUAR



Manuar

Cat. No.	Description	HSN	GST%	Price
812-005	Vermiculite 25(kg)		18%	1100
812-006	Perlite 15 (kg)		18%	1680
812-007	Soilrite 5 (kg)		18%	700
812-008	Agro Peat 25 (kg)		18%	1150

PARAFIN COATED PAPER (WAX PAPER)

These wax paper sheets are so great...I use my envelope template to make vintage mini envelopes, I wrap small gifts with them but I mostly use them for tissue paper. Since so many of my packages I sell are small, they are the perfect size instead of the regular large tissue paper sheets. Be Green :)



Parafin Coated Paper (Wax Paper)

Cat. No.	Description	HSN	GST%	Price
812-009	50x 38 cm		18%	1200

BLOTTING PAPER



Cat. No.	Description	HSN	GST%	Price
812-010	46x57 cm Mill Made		18%	4150
812-011	46x57 cm Hand Made		18%	2450

LABORATORY SPATULA



laboratories, spatulas and micro spatulas are small stainless steel utensils, used for scraping, transferring, or applying powders and paste like chemicals or treatments. Many **spatula** brands are also resistant to acids, bases, heat, and solvents, which make them ideal for use with a wide range of compound.

Laboratory Spatula				
Cat. No.	Description	HSN	GST%	Price
812-012	6" Polypropylene		18%	280
812-013	8" Polypropylene		18%	340
812-014	6" One Side Spoun SS		18%	950
812-015	8" One Side Spoun SS		18%	1150
812-016	10" One Side Spoun SS		18%	1900
812-016	6" One Side Wire SS		18%	1250
812-017	8" One Side Wire SS		18%	1150
812-018	10" One Side Wire SS		18%	1300
812-019	6" One Side Arrow SS		18%	1300
812-020	8" One Side Arrow SS		18%	1900

MICROCOVER GLASSES

These microscope cover glasses are corrosion-resistant and uniformly thin and flat. The processing techniques result in superior cleanliness. Cover glasses are free from bubbles, scratches, and striations. Thickness: 0.17-0.25mm



Micro cover Glasses				
Cat. No.	Description	HSN	GST%	Price
812-021	18x18 (10gms)		18%	135
812-022	22x22 (10 gms)		18%	135
812-023	22x30 (10 gms)		18%	135
812-024	22x40 (10 gms)		18%	135
812-025	22x50 (10 gms)		18%	135
812-026	24x 50 (10 gms)		18%	140
812-027	24x60 (10 gms)		18%	140

OPTICA CELLS (CUVETTES)

A cuvette is a small tube-like container with straight sides and a circular or square cross section. It is sealed at one end, and made of a clear, transparent material such as plastic, glass, or fused quartz.

Optica Cells (cuvettes)				
Cat. No.	Description	HSN	GST%	Price
812-028	10mm 12.5x12.5x45 (3.50ml)		18%	3400
812-029	20mm 12.5x22.5x45 (7.00ml)		18%	6000
812-030	40mm 12.5x42.5x45 (14.00ml)		18%	10990
812-031	50mm 12.5x52.5x45 (17.00ml)		18%	12490
812-032	100mm 12.5x102.5x45 (35.00ml)		18%	24970
812-033	10mm Oblique midget 12.5x12.5x45 (1.40ml)		18%	11200
812-034	10mm Oblique midget 12.5x12.5x45 (1.00ml)		18%	12000
812-035	10mm 12.5x12.5x45 (0.7ml)		18%	9900
812-036	1mm 12.5x3.5x45 (0.35ml)		18%	12000



OPTICA CELLS FOR SPECTROPHOTOMETER GLASS

Polarimetric Measurement for some applications, e.g. in polarimetri and for circular dichroism measurements, it is important to check that the cells are free of strain birefringence. The effect of possible strain birefringence is determined in the following way: In a polarimeter the rotation of the plane of polarisation of the incident linearly polarised light is measured. The measurement is carried out in a circular area of approximately 3 mm diameter whose centre coincides with the centre height of the empty cell. Because of the measuring geometry, only cells with an aperture diameter or aperture width of greater than 3 mm can be measured in this way

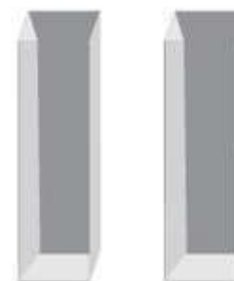

Optica Cells For Spectrophotometer Glass

Cat. No.	Description	HSN	GST%	Price
812-037	10mm 12.5x12.5x45 (3.50ml)		18%	1600
812-038	20mm 12.5x22.5x45 (7.00ml)		18%	2700
812-039	40mm 12.5x42.5x45 (14.00ml)		18%	3500
812-040	50mm 12.5x52.5x45 (17.50ml)		18%	4250
812-041	100mm 12.5x102.5x45 (35.00ml)		18%	8500
812-042	Oblique midget (black)10mm 12.5x12.5x45 (1.40ml)		18%	8150
812-043	Oblique midget 10mm 12.5x12.5x45 (0.7ml)		18%	8840

OPTICA CELLS FOR SPECTROPHOTOMETER QUARTZ

Our Cuvettes are high-quality cells designed to hold liquid samples. The UV fused quartz glass construction allows these cuvettes to be used with UV light at wavelengths as low as 200 nm, as well as with visible and infrared light up to 3 μ m. We offer cuvettes with either two polished sides, for use in absorption spectroscopy experiments, or four polished sides, for use in fluorescence spectroscopy. The polished sides can be cleaned using standard optics cleaning procedures. Versions are also available with one of two PTFE tops: a cap to block dust and other particles or a stopper to prevent evaporation and provide an airtight seal



Optica Cells For Spectrophotometer Quartz

Cat. No.	Description	HSN	GST%	Price
812-044	10mm 12.5x12.5x45 (3.5ml)		18%	15300
812-045	10mm 12.5x12.5x45 (1.4ml)		18%	16830
812-046	10mm 12.5x12.5x45 (0.7 ml)		18%	17850

Optica Cells For Flourimeter-Quartz

Cat. No.	Description	HSN	GST%	Price
812-047	3.5ml 10mm macro		18%	14450
812-048	1.4ml 10mm micro		18%	27200
812-049	0.5ml 10mm micro		18%	28900

Optica Cells For Flourimeters-Glass

Cat. No.	Description	HSN	GST%	Price
812-050	3.5ml 10mm macro		18%	12025
812-051	1.4ml 10mm micro		18%	19550
812-052	0.5ml 10 mm micro		18%	25415

PESTEL AND MORTARS

Pestel And Motors

Cat. No.	Description	HSN	GST%	Price
812-053	60mm (40ml)		18%	200
812-054	75mm (80ml)		18%	250
812-055	85mm (125ml)		18%	300
812-056	100mm (175ml)		18%	400
812-057	125mm (275ml)		18%	600
812-058	150mm (450ml)		18%	750
812-059	175mm (600ml)		18%	850
812-060	200mm (1000ml)		18%	980
812-061	Teflon cups for digestion(50ml)		18%	1300
812-062	PESTLE-MORTAR WOODEN		18%	5500



TEST SIEVES

The majority of sieving methods and practices specify test sieves meeting ASTM E11 or ISO 565/3310-1 specifications. These two specifications have become more closely harmonized in recent years to simplify international use. Refer to the **sieve sizes** reference chart.

AASHTO M92 is a specification often used by state or federal transportation agencies and closely follows ASTM E11. Test Sieves meeting these specifications are supplied in Compliance Grade; serial numbered and supplied with a certificate of manufacturing conformance.

For applications where documented accuracy is required, Compliance Grade sieves can be upgraded to Inspection or Calibration Grades by adding the appropriate Gilson Verification Service to your order.

- **ASTM Test Sieves** are available in all mesh sizes, with frames and mesh constructed of stainless steel, brass or combination brass frame and stainless steel cloth. These sieves meet ASTM E11 and AASHTO M92 requirements. Selection of frame diameter and full or half-height configuration is based on specimen volume and particle size.
- **ASTM Supplemental Sieves** comply with ASTM E11 which incorporates a new range of opening sizes for test sieves (supplemental sizes), intended to supplement existing sizes. Gilson offers these Metric Alternative sizes in stainless steel cloth installed in conventional 3in, 8in, and 12in diameter stainless steel frames.
- **ISO Test Sieves** are based on SI, or metric dimensions, with 200mm or 300mm diameter and all ISO mesh sizes available. These sieves meet ISO 565 and 3310-1 specifications. They are constructed of stainless steel frame and mesh or brass frame with stainless steel mesh, and come in full- or half-height sizes.
- **Wet-Wash Sieves** feature durable extra-deep brass or stainless steel frames to contain wash water, avoid sample loss and allow accurate and efficient preparation and testing of materials. Some models are designed with interchangeable screens and discs that are easily replaceable for extended service life. The Elutriation Sieve is a unique design, well suited for washing samples with high fines contents.
- **3" Acrylic Frame Test Sieves** are designed for the **GA-6 Gilsonic Autosiever** and other Sonic Sifters. Acrylic Frame Test Sieves are precision-made and allow enhanced visibility during testing. Available fitted with ASTM E11 woven wire cloth or ASTM E161 Precision Electroformed Mesh, these sieves can also be substituted for 3in metal frame sieves when using the **3in Vibratory Sieve Shaker**. E11 Acrylic Frame Test Sieves are designed to reduce sample loss, while the ASTM E11 Precision Electroformed Mesh Sieves offer precise particle sizing of fine powders.
- **Air Jet Sieves** are special test sieves required for use with old-style Micron Air Jet Sieves. They have stainless steel frames with stainless steel mesh, and can be upgraded from Compliance Grade to Inspection or Calibration Grade when ordering by specifying Gilson Verification Services. They can also be easily modified for use with the new Mikro Air Jet Sieve™.
- **ASTM Precision Electroformed Sieves** are available in a wide range of opening sizes. Accuracy to $\pm 2\mu\text{m}$ makes the ASTM Precision Electroformed Sieve the ideal choice for very fine powders. The mesh is formed by electrodeposition of nickel onto a precisely-sized grid form. Electroformed sieves have 8in or 3in frames with extremely accurate mesh openings in sizes as small as $5\mu\text{m}$. They comply with ASTM E161 and ISO 565/3310-3 requirements. Come with a Certificate of Compliance.
- **Two-Part Replaceable Mesh Sieves** are available in clear non-metallic polycarbonate or brass. The 8in diameter sieve frames use replaceable non-metallic cloth that is easily removed and discarded after use. The sieve cloth is made of monofilament polyester or nylon and is ideal for materials that are sensitive or hazardous, or when cross-contamination is a concern.
- **3" Non-Metallic Sieves** are non-metallic test sieves hand-made by Gilson, and useful for wet sieving of small samples. Each sieve features a clear polycarbonate frame and polyester mesh. The clear frame offers easy viewing of wet sieving operations. The sieves seal when nested, are autoclaveable, and microwaveable for drying.

Sieve Size Comparison Chart

ASTM E11			ISO 565/ 3310-1	ASTM E11			ISO 565/ 3310-1	ASTM E11			ISO 565/ 3310-1
Standard	Alternate	Size		Standard	Alternate	Size		Standard	Alternate	Size	
100.0mm	4in	-		-	-	5.0mm		355µm	No.45	355µm	
90.0mm	3 1/2in	-		4.75mm	No.4	4.75mm		-	-	315µm	
75.0mm	3in	-		-	-	4.50mm		300µm	No.50	300µm	
63.0mm	2 1/2in	63.0mm		4.00mm	No.5	4.00mm		-	-	280µm	
-	-	56.0mm		3.55mm	-	3.55mm		250µm	No.60	250µm	
53.0mm	2.12in	53.0mm		3.35mm	No.6	3.35mm		-	-	224µm	
50.0mm	2in	50.0mm		-	1/8in*	-		212µm	No.70	212µm	
45.0mm	1 3/4in	45.0mm		3.15mm	-	3.15mm		-	-	200µm	
-	-	40.0mm		2.80mm	No.7	2.80mm		180µm	No.80	180µm	
37.5mm	1 1/2in	37.5mm		-	-	2.50mm		-	-	160µm	
-	-	35.5mm		2.36mm	No.8	2.36mm		150µm	No.100	150µm	
31.5mm	1 1/4in	31.5mm		2.00mm	No.10	2.00mm		-	-	140µm	
-	-	28.0mm		-	-	1.80mm		125µm	No.120	125µm	
26.5mm	1.06in	26.5mm		1.70mm	No.12	1.70mm		-	-	112µm	
25.0mm	1in	25.0mm		-	-	1.60mm		106µm	No.140	106µm	
22.4mm	7/8in	22.4mm		1.40mm	No.14	1.40mm		-	-	100µm	
-	-	20.0mm		-	-	1.25mm		90µm	No.170	90µm	
19.0mm	3/4in	19.0mm		1.18mm	No.16	1.18mm		-	-	80µm	
18.0mm	-	18.0mm		-	-	1.12mm		75µm	No.200	75µm	
16.0mm	5/8in	16.0mm		1.00mm	No.18	1.00mm		-	-	71µm	
-	-	14.0mm		-	-	900µm		63µm	No.230	63µm	
13.2mm	0.530in	13.2mm		850µm	No.20	850µm		-	-	56µm	
12.5mm	1/2in	12.5mm		-	-	800µm		53µm	No.270	53µm	
11.2mm	7/16in	11.2mm		710µm	No.25	710µm		-	-	50µm	
-	-	10.0mm		-	-	630µm		45µm	No.325	45µm	
9.5mm	3/8in	9.5mm		600µm	No.30	600µm		-	-	40µm	
-	-	9.0mm		-	-	560µm		38µm	No.400	38µm	
8.0mm	5/16in	8.0mm		500µm	No.35	500µm		-	-	36µm	
-	-	7.1mm		-	-	450µm		32µm	No.450	32µm	
6.7mm	0.265in	6.7mm		425µm	No.40	425µm		25µm	No.500	25µm	
6.3mm	1/4in	6.3mm		-	-	400µm		20µm	No.635	20µm	
5.6mm	No. 3 1/2	5.6mm		-	-	-		-	-	-	

Sieve mesh sizes are based on dimensions of the mesh size opening, or on the number of openings per linear inch. The two major standards governing test sieves and appropriate sizes are ASTM E11 and ISO 565/3310-1, both of which specify parameters for aperture dimensions, mesh size, and statistical variations.

Opening sizes and mesh diameters for test sieves are often duplicated between these two standards, making it easier to select the proper sieve size for your material. The above table is a list of all available sieves in U.S. and metric sizes for both ASTM E11 and ISO 565/3310-1. Sieve mesh opening sizes range from 5in (125mm) down to #635 (20µm). The table outlines the standard, an alternate and the recommended sizes.

Gilson test sieves for particle size analysis of fine or coarse materials, soil, powder and other applications are available with brass or stainless steel frames fitted with brass or stainless steel cloth meeting ASTM or ISO standards. Common frame diameters, 3in (76mm), 8in (203mm), and 12in (305mm), as well as many ISO sizes in 200 mm and 300 mm frames, are in stock ready to ship. Other frame sizes such as 6in (152mm), 10in (254mm), and 18in (457mm) can be ordered. ASTM wire cloth is available cut-to-order or in bulk.

Test Sieves				
Cat. No.	Description	HSN	GST%	Price
812-063	4.75mm		18%	1300
812-064	3.35mm		18%	1300

Test Sieves				
Cat. No.	Description	HSN	GST%	Price
812-065	2.80mm		18%	1300
812-066	2.36mm		18%	1300

Test Sieves				
Cat. No.	Description	HSN	GST%	Price
812-067	2.00 mm		18%	1300
812-068	1.70mm		18%	1300
812-069	1.40mm		18%	1300
812-070	1.18mm		18%	1300
812-071	1.00mm		18%	1300
812-072	850microns		18%	1300
812-073	710microns		18%	1300
812-074	600microns		18%	1300
812-075	500microns		18%	1300
812-076	425microns		18%	1300
812-077	355microns		18%	1300
812-078	300microns		18%	1300
812-079	250microns		18%	1300
812-080	212microns		18%	1300

Test Sieves				
Cat. No.	Description	HSN	GST%	Price
812-081	180microns		18%	1300
812-082	150microns		18%	1300
812-083	125microns		18%	1300
812-084	106microns		18%	1500
812-085	90 microns		18%	1500
812-086	75 microns		18%	1700
812-087	63microns		18%	1900
812-088	53microns		18%	1900
812-089	45microns		18%	2000
812-090	44 microns		18%	2100
812-091	40 microns		18%	3500
812-092	38 microns		18%	4200
812-093	25 microns		18%	4600

SMARTCOAT DECONTAMINANTS



- Decomposing anything organic in nature (like micro-organisms) which comes into contact with, or onto a treated area. Bacteria, viruses, fungi and many other airborne contaminants being typical examples:
- SmartCoat's technology utilizes any light source to activate its oxidative ability when it is applied onto surfaces.
- Through this process, SmartCoat's surfaces are able to break any organic matters upon contact.

SmartCoat DeContaminants				
Cat No.	Description	HSN	GST	Price
812-100	Aromr8 (250 ml)	28230010	18%	18577
812-101	Aromr8 MINI (150 ml)	28230010	18%	18057
812-102	Aromr8 Micro (60ml)	28230010	18%	17667

SmartCoat DeContaminants				
Cat No.	Description	HSN	GST	Price
812-103	Smartcoat Nano Tio2 (500 ml)	28230010	18%	148850
812-104	Aromr8 (250 ml)	28230010	18%	18577

DISINFECTANT SPRAY



- kills a broad spectrum of microorganisms namely viruses, mold, mildew, Algae, fungi, yeasts, gram (+) and (-) bacteria
- This product is a multi-surface cleaner and disinfectant. Use on windows, mirrors, and other non-food contact surfaces.
- Base/Active : Quarternary Ammonium Chloride
- Organisms : Aspergillus Niger, CA Methicillin Resistant Staph (CA-MRSA), HBV Hepatitis B Virus, HCV Hepatitis C Virus, HIV-1 Aids Virus, Human Coronavirus, Influenza A (H1N1) virus, Legionella pneumoniae, Listeria monocytogenes, Methicillin Resistant Staph (MRSA), Newcastle virus, SARS associated coronavirus, Staphylococcus, Streptococcus, Trichophyton (Athletes Foot), Trichophyton (Ring Worm)
- Effective for more than 30 days
- Expiry : 1 year

Disinfectant Spray				
Cat. No.	Description	HSN	GST%	Price
DIS-SPR	Disinfectant Spray 1Ltr		18	3800

DNA DEGRADATION SOLUTION



DNA-ExitusPlus™ solutions employ a mild and non-corrosive chemistry for a rapid non-enzymatic degradation of nucleic acids. Already short incubation times with DNA-ExitusPlus™ completely remove unwanted DNA and RNA from work surfaces and tools.

Actual pictures may vary depending upon the availability.

DNA DEGRADATION SOLUTION				
Cat. No.	Description	HSN	GST%	Price
A7089,0500D	DNA-ExitusPlus™ 500ml		18%	19850

RNA DEGRADATION SOLUTION

RNase ExitPlus eliminates RNase and DNA from laboratory surfaces. Ideal for decontaminating apparatus, bench-tops, glassware and plasticware. Reduces dependency on carcinogenic DEPC treatments and saves time needed to bake glassware.

Actual pictures may vary depending upon the availability.



RNA DEGRADATION SOLUTION				
Cat. No.	Description	HSN	GST%	Price
A7089,0250R	RNase-ExitPlus 250ml		18%	14005

COTTON ROLLS



- Cotton Rolls absorbent.

Actual pictures may vary depending upon the availability.

COTTON ROLLS				
Cat. No.	Description	HSN	GST%	Price
SB-M02A	Cotton Rolls absorbent 2 rolls pack		18%	405

LAB UTILITY TRAY



Lab Utility Tray / Ice Bucket / Ice Basket
Actual pictures may vary depending upon the availability.

Lab Utility Tray/ Ice Bucket / Ice Basket				
Cat. No.	Description	HSN	GST%	Price
712-633A	Utility Tray 350x275x75 (mm) 6 pcs/pk		18%	1900
712-633B	Utility Tray 360x310x125 (mm) 6/pk		18%	3475

THERMO CONDUCTIVE RACK

Thermo Conductive Rack 96 PCR Tubes or Strips or Plate
For 384 well PCR plate
Actual pictures may vary depending upon the availability.



THERMO CONDUCTIVE RACKS

Cat. No.	Description	HSN	GST%	Price
712-131D	Thermo Conductive Racks for 96/24 well plates/Tubes 1pc/pk		18%	6475
712-131E	Thermo Conductive Racks for 384 well plates 1pc/pk		18%	8600

AUTOMATIC HAND SANITIZER DISPENSER (WALL MOUNTED) Contactless hand sanitizer

Contactless hand sanitizer A new Standard of Hygiene
Touch Free dispenser
Consistent, Accurate Dispensing
Meets ADA requirements for walkways and corridors
Foaming Products for great coverage with less consumption



rusting, wear and tear

Sanitizer

Any liquid sanitizer can be used in this dispensing machine.

Dispensing

Every dispensing cycle is of 5 ml. This machine can work for 2500 cycles of hand sanitizing before next refilling.

Capacity

The tank in the machine has capacity of 12-15 liters.

Power supply

Standard 220v AC supply from wall socket.

- Perfect use for Public Washroom, Hotels, Hospitals, Homes, Schools and Offices
- Completely comfortable.
- Sanitize your hands within 5-10 seconds
- Material: ABS Plastic, Easily mountable on the wall, Long Lasting, elegant and durable ABS cover for protection against

AUTOMATIC HAND SANITIZER DISPENSER

Cat. No.	Description	HSN	GST%	Price
712-029S1	Automatic Hand Sanitizer Dispenser Sprayer with sensor	84192090	18	8500
712-029S2	Automatic Hand Sanitizer Non-Liquid Infrared sensor	84192090	18	12500

BIOLOGICAL INDICATORS

STERIS Spordex® Biological Indicator Strips are specifically designed for determining the effectiveness of steam, ethylene oxide (EO) and dry heat sterilization procedures. Each strip is inoculated with bacterial spores, either *Bacillus atrophaeus* (BA) (formerly *Bacillus subtilis* var. niger) for ethylene oxide and dry heat sterilization or *Geobacillus stearothermophilus* (GS) for saturated steam sterilization. Each easy to peel glassine pouch has the lot number, organism and expiration printed on it. Spordex Biological Indicator Strips are available in a variety of standard populations as well as custom configurations.



HOW SPORDEX STRIPS WORK

Spordex Biological Indicator Strips are small strips of special filter paper inoculated with bacterial spores, either *Bacillus atrophaeus* (BA) for ethylene oxide and dry heat sterilization or *Geobacillus stearothermophilus* (GS) for saturated steam sterilization. Each strip is packaged in a glassine envelope and is used to validate or requalify sterilization processes.

WHY SPORDEX STRIPS?

- **Ease of Use** - Individually packaged strips in sterilizable envelopes for easy placement in your test pack.
- **Reliability** - Lot number and expiration printed on each glassine envelope.
- **Easy to Validate** - Each lot is documented with population and resistance for either *B. atrophaeus* and *G. stearothermophilus* spores.
- **Efficacy** - Meet the suggested performance parameters published in the current USP standards.
- **Flexibility** - Custom designed strips with defined populations or D-value ranges are available.

Actual pictures may vary depending upon the availability.

Biological & Chemical Indicators				
Cat. No.	Description	HSN	GST%	Price
Indc-100A	Biological Indicator Strips (100 strips/Box)	3918 1099	18%	60005
Indc-500A	Biological Indicator Strips (500 strips/Box)	3919 1099	18%	164587
INDC-100	Radiation Chemical Process indicator 1x5000no	3920 1099	18	9119
INDC-101	Steam Chemical Process indicators 1x5000no	3920 1099	18	9565
INDC-102	Ethylene Oxide (EO) Chemical Process indicators 1x5000no	3920 1099	18	9565
INDC-103	Dry Heat Chemical Process indicators 1x500no	3920 1099	18	16825
INDC-104	Dry Heat Chemical Process indicators 1x1000no	3920 1099	18	19333
INDC-105	Steam Indicator Tape	3920 1099	18	902
INDC-106	EO Indicator Tape	3920 1099	18	2156
INDC-107	Steam Indicator Strip 1x250no	3920 1099	18	6303
INDC-108	Bowie & Dick Test Pack 1 X 5pk	3920 1099	18	2734
INDC-109	Bowie & Dick Test Pack 1 x 20pk	3920 1099	18	10258

Biological & Chemical Indicators				
Cat. No.	Description	HSN	GST%	Price
INDC-110	Geobacillus stearothermophilus 1 x 25no	3920 1099	18	5891
INDC-111	Geobacillus stearothermophilus 1x 100no	3920 1099	18	22979
INDC-112	Geobacillus stearothermophilus1x25no	3920 1099	18	3427
INDC-113	Geobacillus stearothermophilus1x100no	3920 1099	18	13338
INDC-114	B. atrophaeus 1x25no	3920 1099	18	2739
INDC-115	B. atrophaeus 1x100no	3920 1099	18	10687
INDC-116	Geobacillus Stearothermophilus Ampoule 1x25no	3920 1099	18	6622
INDC-117	Geobacillus Stearothermophilus Ampoule 1x50no	3920 1099	18	12051
INDC-118	Geobacillus Stearothermophilus Ampoule 1x25no	3920 1099	18	13789
INDC-119	Geobacillus Stearothermophilus Ampoule 1x50no	3920 1099	18	25075

CHEMICAL INDICATORS



STERIS Steraffirm™ Bowie Dick Test Packs are pre-assembled single-use test packs designed to evaluate the performance of the air removal system of a pre-vacuum equipped sterilizer. Several versions of these test packs are available. They are calibrated to be compatible with pre-vacuum cycles operating at specific exposure temperatures or within a specified exposure temperature range (e.g., 121° C/250° F). They conform to the ISO 11140 (Type 2) standards. They are for use in Life Sciences applications only. They are not cleared for use in healthcare facilities in the United States.

HOW STERAFFIRM BOWIE DICK TEST

PACKS WORK

STERIS Steraffirm Bowie Dick Test Packs should be placed over the drain each day to test your pre-vacuum steam sterilizer. During the cycle, the indicator ink will change from yellow to a blue/purple color. After the cycle is complete, the indicator card can be removed and kept for your records. Steraffirm Bowie Dick Test packs can help identify a problem before you have sterilization failures while helping to identify the potential source of the problem.

WHY STERAFFIRM BOWIE DICK TEST PACKS?

- **Reliability** - Preassembled single use test provides consistent testing of the pre-vacuum steam sterilizer cycles.
- **Productivity** - Distinctive, total color change from yellow to a blue/purple color provides a clear indication of a successful test.
- **Easy to Validate** - Each pack and indicator has a lot number and expiration date printed on it for easy documentation.
- **Efficacy** - Conforms to ISO 11140 Type 2 standards.
- **Flexibility** - Indicator can detect wet steam, superheated steam, and noncondensables in the steam supply to aid troubleshooting problems.

Actual pictures may vary depending upon the availability.

STERAFFIRM BOWIE DICK TEST PACKS

Cat. No.	Description	HSN	GST%	Price
Chem-Indc-1	STERAFFIRM BOWIE DICK TEST PACK FOR 121-124DEG C 20/BX		18%	92005

PPE KIT (PERSONAL PROTECTIVE EQUIPMENT)



PERSONAL PROTECTIVE EQUIPMENT- PPE KIT

COVERALL SPUNBOND POLY WITH LAMINATED HOOD	1 PC
SHOE COVER	1 PAIR
PROTECTING GOGGLES	1 PC
NITRILE GLOVES	1 PAIR
BOUFFANT CAP	1 PC
3 PLY SURGICAL MASK	1 PC
DISPOSABLE BAG	1 PC

SIZE
XL

ISO, GMP, CE CERTIFIED COMPLIANT



- Anti-bacteria. Antistatic, anti-alcohol, anti-plasma, water-repellent
- Non-woven fabric is made of spun bond non-woven fabric. Collarless hood, elasticated brim.
- Made of high quality polypropylene to provide protection, duality for use in non-hazardous environments for working and comfortable and breathable
- Useful in clinics, hospitals, laboratories, workshops, construction sites, painting, commercial and household inspections, keeping off insulation, for general isolation and protection

Pack Contains :

- >One Coverall Suit with Hood (Non Woven - 50 gsm) : 01
- >Pair of examination gloves : 01
- >Pair of Shoe cover : 01
- >One Face Mask, 3 Ply Stitch Elastic Loop : 01
- >Goggle : 01
- >Garbage Bag : 01

PPE Kit				
Cat. No	Description	HSN	Pk	Price/Pk
500-540B	PPE Kit Laminated 85 GSM 10pcs/pk	6307	1	15050
500-540C	PPE Kit Non Laminated 85 GSM 10pcs/pk	6307	1	12500
500-540D	PPE Kit for High Security Diseases 10pcs/pk	6307	1	20310

MICROTIP BOXES

- **Pipette Tip Box:** Material: PP , Stackable & Sturdy , Clear Lid , Lid lock design
- Withstand Autoclaving and Freezing
- Compatible with Standard & Premium Range of Pipette Tips
- Compatibility with Axygen, Thermo, Eppendorf, Tarsons, Abdos, Pristipet, Socorex and many others



Pipette Tips Box

Cat. No.	Capacity	HSN	GST %	Price
PB-1114-20	Pipette Tips box 10ul 10bx/pk	39231090	18	1618
PB-1114-21	Pipette Tips box 10ul long 10bx/pk	39231090	18	1618
PB-1114-22	Pipette Tips box 200ul 10bx/pk	39231090	18	1618
PB-1114-23	Pipette Tips box 1000ul 10bx/pk	39231090	18	2105
PB-1114-24	Pipette Tips box 1250ul 10bx/pk	39231090	18	2738
PB-1114-25	Pipette Tips box 5000ul 10bx/pk	39231090	18	5253

PIPETTE TIPS



- **Pipette Tips: Graduated, High Clarity**
- **Certified free of detectable RNase, DNase, DNA and pyrogens**
- **Autoclavable, Gamma Sterile available**
- **Universal fit, Compatible with standard & Premium range of pipettes**
- **Compatibility with Axygen, Thermo, Eppendorf, Tarsons, Abdos, Pristipet, Socorex and many others**

Pipette Tips Bulk & Rackd

Cat. No.	Capacity	HSN	GST %	Price/Pack
PB-1114-01	10ul Clear, Bulk 1000/Bag, 10Bag/Pack	3923 1090	18	5720
PB-1114-02	10ul Clear, Bulk Sterile 1000/Bag, 10Bag/Pack	3923 1090	18	6380
PB-1114-03	10ul Clear, Racked Sterile 20 Rack/Pack	3923 1090	18	4675
PB-1114-04	10ul long Clear, Bulk 1000/Bag, 10Bag/Pack	3923 1090	18	5720
PB-1114-05	10ul long Clear, Bulk Sterile 1000/Bag, 10Bag/Pack	3923 1090	18	6380
PB-1114-06	10ul long Clear, Racked Sterile 20 Rack/Pack	3923 1090	18	4675
PB-1114-07	200ul Clear, Bulk 1000/Bag, 10Bag/Pack	3923 1090	18	4345
PB-1114-08	200ul Clear, Bulk Sterile 1000/Bag, 10Bag/Pack	3923 1090	18	5225
PB-1114-09	200ul Clear, Racked Sterile 20 Rack/Pack	3923 1090	18	4675
PB-1114-10	1000ul Clear, Bulk 500/Bag, 10 Bag/Pack	3923 1090	18	3795
PB-1114-11	1000ul Clear, Bulk Sterile 500/Bag, 10 Bag/Pack	3923 1090	18	5005
PB-1114-12	1000ul Clear, Racked Sterile 20 Rack/Pack	3923 1090	18	6325
PB-1114-13	5000ul Clear, Bulk 250/Box, 5 Box/Pack	3923 1090	18	5912
PB-1114-14	5000ul Clear, Bulk Sterile 250/Box, 5 Box/Pack	3923 1090	18	7095
PB-1114-15	5000ul Clear, Racked Sterile 20 Rack/Pack	3923 1090	18	14740
PB-1114-16	5000ul Long Clear, Bulk 250/Box, 5 Box/Pack	3923 1090	18	6875
PB-1114-17	5000ul Long Clear, Bulk Sterile 250/Box, 5 Box/Pack	3923 1090	18	8057
PB-1114-18	5000ul Long Clear, Racked Sterile 20 Rack/Pack	3923 1090	18	16500

FILTER TIPS

- **Universal Fit, Compatibility with Axygen, Thermo, Eppendorf, Tarsons, Abdos, Pristipet, Socorex and many others.**
- **Only Racked & Sterile. Because bulk filter tips lose its blocking capacity after autoclaving.**
- **Prevents Both Liquid & Aerosol passing through the filter.**
- **Best Suited for Biological application.**
- **Filters are 100% pure porous PE makes Recovery of Samples from Wetted, Filtered without Contamination.**
- **Non Cytotoxic (ISO 10993-5 MRM, Minimal Essential Media Elution, GLP Compliant).**
- **99.9% Bacterial Aerosol Filtration Efficiency (BFE), (ASTM F21012).**
- **Non Hemolytic (Modified ASTM F 756-08 Hemolysis Direct Contact GLP with Human Blood).**
- **Inert, Hydrophobic Filter does not trap or block the liquid.**



Filter Tips				
Cat. No.	Description	HSN	GST%	Price
PB-1114-29	StarLab Pipette Filter Tips 100 - 1000µl, 10 x 96 x 5, Racked sterile	84799090	18%	27995
PB-1114-32	StarLab Pipette Filter Tips 1-200µl 10 x 96 x 5, Racked sterile	84799090	18%	24995
PB-1114-30	StarLab Pipette Filter Tips 1-100µl bevelled, 10 x 96 x 5, Racked sterile	84799090	18%	30195
PB-1114-33	StarLab Pipette Filter Tips 1-50µl bevelled 10 x 96 x 5, Racked sterile	84799090	18%	28995
PB-1114-27	StarLab Pipette Filter Tips 0,5-20µl, 10 x 96 x 5, Racked sterile	84799090	18%	24995
PB-1114-26	StarLab Pipette Filter Tips 0,1-10µl, 10 x 96 x 5, Racked sterile	84799090	18%	24995

MANUAL SPRAYER HEAVY DUTY

- * Tank Capacity : 16 Ltrs
 - * POM resistant Piston
 - * High quality rocker bar
 - * Every product is 100% examined especially for the product function
 - * Durable heavy plastic material have a long time to use and resist acid and corrosion
- Use for Agricultural Spray Purpose only



4 Stroke power sprayers :

Technical Details :

Engine : 34CC, 2 Stroke Petrol

Carburetor : Diaphragm Type

Ignition System : T.C.I.,

Max Power (In Kw./RPM) : 0.75 kw/ 8500

Max Power (In Hp) : 1 Hp

Engine RPM : 8500

Working RPM : 7000

Start System : Recoil Starter

Fuel Tank Capacity : 700 ml

Use for Agricultural Spray Purpose only

Actual pictures may vary depending upon the availability.

AGRICULTURAL SPRAYERS				
Cat. No.	Description	HSN	GST%	Price
Agro-Spray-M1	Agricultural Sprayers Manual 16ltrs		18%	4895
Agro-Spray-D1	Agricultural Sprayers 2-in-1 (Manual + battery) operated 16ltrs		18%	6589
Agro-Spray-A1	4 Stroke power sprayers Automatic Sprayers 16ltrs		18%	15789

SAFETY TOUCH KEY

Safety Touch Key:

- **Material:** Cast Grade Acrylic / Metallic also available
- **Size:** Length: 104mm, Height: 69mm
- **Thickenss:** 8mm
- **Price:** Rs.150.00 / pk

Actual pictures may vary depending upon the availability.



Specially designed to be used before, during or after doing any scientific experiment to avoid any contamination



SAFETY TOUCH KEY				
Cat. No.	Description	HSN	GST%	Price
SFT-TOU-01A	Safety Touch Key Acrylic		18%	1300
SFT-TOU-01B	Safety Touch Key Metallic		18%	1500

INFRARED THERMOMETER



INFRARED THERMOMETER

- Three-color Backlight:
 - Green (Normal Temperature)
 - Yellow (Slight Fever)
 - Red (High Fever)
- Longevity use (100,000 readings)
- Accuracy: $\pm 0.2^{\circ}\text{C}$ (0.4°F)
- Automatic power-off: <30 secs
- Memory: 32
- Response Time: 1 sec
- Measuring Time: 1 sec
- Measuring Distance: 3~5CM

Measuring range (body): $32^{\circ}\text{C} \sim 43^{\circ}\text{C}$
 Measuring range (surface): $0^{\circ}\text{C} \sim 60^{\circ}\text{C}$
 Temperature display resolution: $\pm 0.1^{\circ}\text{C}$ (0.1°F)
 Audible alarm if temperature is more than 38°C (100.4°F)

Actual pictures may vary depending upon the availability.

INFRARED THERMOMETER				
Cat. No.	Description	HSN	GST%	Price
INFR-01	Infrared Thermometer		18%	3450
INFR-01	Infrared Thermometer		18%	7450

OXYGEN KIT

OXYGEN KIT WITH MASK, HUMIDIFIER & TUBING & CYLINDER.



WATER CAPACITY 10 LITERS

Duration Approx 13 hrs @ speed of 2 Liters

* Duration specified is @2 liter per minute

- A complete oxygen medical kit that is 45 % lighter than traditional steel cylinders.
- Refillable and reusable.
- With its cylinder made

from aluminum alloy, OxyGo is completely rust free unlike Iron & other materials.

- The simple finger operated valve and regulator that can be used by the patient.
- Oxygen quality within the cylinder maintained due to its internal aluminum finish and special internal cleaning process.

*Actual pictures may vary depending upon the availability.

OXYGEN KIT

Cat. No.	Description	HSN	GST%	Price
OXYK-01M	Oxygen Kit 10 Ltrs. Metallic		18%	18550
OXYK-01M	Oxygen Kit 10 Ltrs. Aluminium		18%	23500

DIGITAL THERMOMETER

DIGITAL THERMOMETER

Standard Features:

- Numeric display - easy to read
- With Beep Alert
- Mercury Free (environmental friendly)
- Unbreakable
- High Precision
- Measurement Range: 32-42°C & 89.6-109.4°F
- Display Resolution: 0.1°C & 0.1°F
- Easy Replaceable Battery
- Auto power off 8 minutes
- Last measurement memory
- In plastic case



DIGITAL THERMOMETER

Cat. No.	Description	HSN	GST%	Price
DIGITHERM-01	Digital Thermometer		18%	250

Physics / Chemistry Consumables

Physics / Soil Science Consumables Price List

S.NO.	Item Name	Price Each
1	<u>SciBio Total Station AL-200 Series Global Positioning System</u> (Packing 1pcs) Complete With All Accessories In Original Box With Following Accessories - Stand For Total Station Packed In Canvas Cover -Prism Group: Prism With Target Plate And Holder Packed In Canvas Cover -Prism Pole Packed In Canvas Cover. -Battery -Software -Manual	
	(A) SciBio Total Station AL-215(5 Sec accuracy)	285600
	(B) SciBio Total Station AL-212(2Sec accuracy)	299200
	(C) SciBio Total Station AL-212R(2Sec accuracy) with reflector less	394400
	(D) SciBio Total Station AL-212RC (2Sec accuracy) with reflector less with memory card	516800
	(E) SciBio Total Station AL-212RCL (2 Second Accuracy with Reflector less & Memory Card, with Laser Guide Light)	571200
	(F) SciBio Total Station AL-212RCW (2Sec accuracy) with reflector less with memory card with window system	870400
2	<u>SURVEYING & MAPPING SOFTWARE SciBio CASS 2008 of Topographic, Land Management, City Planning, Municipality, Geology</u>	29920
3	<u>SciBio Electronic Theodolite AL-2000 Series (Packing 1 pcs)</u>	
	(A) SciBio Electronic Theodolite AL-2005 (5Sec accuracy)	87040
	(B) SciBio Electronic Theodolite AL-2002 (2 Sec accuracy)	92480
4	<u>SciBio Automatic Level (Packing 4 pcs)</u>	
	(A)SciBio Automatic Level 20 (20XMagnification)	11424
	(B) SciBio Automatic Level 22 (22XMagnification)	12240
	(C)SciBio Automatic Level 24 (24XMagnification)	13056
	(D)SciBio Automatic Level 26 (26XMagnification)	14688
	(E)SciBio Automatic Level 28 (28XMagnification)	15776
	(F)SciBio Automatic Level 30 (30XMagnification)	16864
	(G)SciBio Automatic Level 32 (32XMagnification)	17680
5	SciBio Digital Level (Packing 1 pcs)	122400
6	Carl Zeiss Micro Optic Theodolite (Packing 1 pcs)	176800
7	<u>SciBio Distance Meter PD Series</u> (Packing 1 pcs)	
	(A)15 Meter	4080
	(B) 40 Meter (PD-54)	7616
	(C) 60 Meter (PD-56)	8704

S.NO.	Item Name	Price Each
	(D) 80 meter (PD-80)	11968
	(E) 120 Meter (PD-120)	24480
	(F) 200 Meter (PD-200)	29920
8	<u>SciBio Cross Line Laser ACL Series</u> (Packing 1pcs)	
	(A)SciBio ACL-211 Vertical/Horizontal Accuracy :±2mm(at 10m) ;Emits 1 Horizontal, 1 Vertical line, 1 plumb-down point; Auto Magnetic Compensation ±2; Working range :10m (indoor)-/30m (with detector)	14960
	(B)SciBio ACL-221-Vertical/Horizontal SciBio ACL-221 Vertical/Horizontal Accuracy :±2mm(at 10m) ;Emits 1 Horizontal, 2Vertical line, 1 plumb-down point; Auto Magnetic Compensation ±2; Working range :10m (indoor)-/30m (with detector)	17680
	(C)SciBio ACL-241 Vertical/Horizontal Accuracy :±2mm(at 10m) ;Emits 1 Horizontal, 4 Vertical line, 1 plumb-down point; Auto Magnetic Compensation ±2; Working range :10m (indoor)-/30m (with detector)	23120
9	SciBio Laser Plummet RC-10Series (Packing 1pcs)	122400
	Standard Deviation:1/45000; Plate Vial Accuracy:20"/20mm;Magnification:25X; WorkingRange:200m(day) /250m (night); Deviation between Vertical & Collimation Axis:5";Deviation between Laser & Collimation Axis:5"; Wave Length: 635nm, Class II; Power Supply:3V(2XAA Batteries)	
10	SciBio Rotary Laser ML-101 Series (Packing 1pcs)	149600
	Rotary Laser: Horizontal Accuracy: ±10",Upward Laser Accuracy: ±5"; Working Range:0.5-200m(with Detector); Compensation Range:±5.7°;Wave Length:635nm;Max.Emitting Power: 1.0mw; Laser Class II/III. Ni-H Rechargeable Battery DETECTOR: Accuracy :±1mm (high) /±2.5mm (low) ;Accuracy of Bubble:30"/2mm; Power Supply:DC9V Batteries	
11	SciBio Digital Planimeter (Packing 1pcs)	
	(A) SciBio	62560
	(B) PLACOM KP90N	70720
12	SciBio Concrete test Hammer (Packing 4pcs)	20400
13	SciBio Prism Group : Prism Target Plate & Prism Holder Packed in Canvas Cover	9520
14	<u>SciBio Complete Prism group :</u> <u>Tribrach, Adopter, Prism Holder, and Prism Packed in Box---</u>	
	(A) Single Prism	28560
	(B) Three Prism	39440
15	<u>SciBio Brunton Compass (Packing 12pcs)</u>	
	(A) DQY-1	8160
	(B) DQL-8	9520
16	Geological Hammer Imported(SciBio)	3264
17	SciBio Measuring Wheel (Packing pcs)	6528
18	<u>G.P.S. Garmin:-</u>	
	(A) Garmin Etrex - 10	19584
	(B) Garmin Etrex - 20	34000
	(C) Garmin Etrex - 30	39440

S.NO.	Item Name	Price Each
	(D) Garmin 72H	25840
19	SciBio Teakwood Telescopic Special Stand For Total Stand & Electronic Theodolite Packed in Canvas Cover (Packing of 2pcs)	9520
20	SciBio Aluminum Telescopic Stand for Automatic Level Packed in Canvas Cover (Packing of 6pcs)	2720
21	<u>SciBio Leveling Staves</u> <u>(Export Quality with Powder Coating)</u> <u>Packing of 10pcs</u>	
	(A) Size 4 meter in four fold	1496
	(B) Size 5 meter in five fold	1768
	(C) Size 6 meter in five fold	2040
22	<u>SciBio Fibre Glass Telescopic Staff</u>	
	(A) 3 Meter in 3 Fold	8160
	(B) 4 Meter in 4 Fold	9520
	(C) 5 Meter in 5 Fold	10880
	(D) 7 Meter in 7 Fold	14960
23	Sunshine Recorder Complete With Chart	19040
24	Sunshine Ball	3264
25	<u>Automatic Level : Complete with all accessories in Fiber Box</u>	
	(A) SUN DS 240 (24 X)	10880
	(B) Sokkia B-40A	33320
26	<u>Dumpy Level (Erect): Complete with all accessories in Fiber Box & Telescopic Aluminum Stand. Packed in Canvas Cover</u> <u>Easy to Handling</u>	
	(A) Size 178 MM (7")	7072
	(B) Size 225 MM (9")	7616
27	<u>Tilting Level (Erect) : Complete with all accessories in Fiber Box & Telescopic Aluminum Stand Packed in Canvas Cover</u>	
	(A) Size 178 MM (7")	7888
	(B) Size 225 MM (9")	8704
28	<u>Dumpy Level : Size 300 MM (12") Complete with Wooden Box & Telescopic Aluminum Stand Packed in Canvas Cover Easy to Handling</u>	
	(A) Mix	9520
	(B) Full Brass	13056
29	<u>Theodolite (Erect): Special Quality in Teakwood Box & Special Quality Telescopic Aluminum Stand Packed in Canvas Cover Easy to Handling</u>	
	(A) 10 sec Accuracy	23120
	(B) 20 Sec Accuracy	21760
30	<u>Theodolite (Erect): Export Quality in Teakwood Box & Export Telescopic Aluminium Stand Packed in Canvas Cover Easy to Handling</u>	
	(A) 10 Sec Accuracy	39440
	(B) 20 Sec Accuracy	36720
31	<u>Prismatic Compass With Aluminum Stand Made of Brass</u>	
	(A) 100 MM (4")	2448
	(B) 125 MM (5")	3264
	(C) 150 MM (6")	4352
32	Survey Compass with Aluminium Stand	2720

S.NO.	Item Name	Price Each
33	Digital Soil Moisture Meter	9520
34	Weather Station Complete	
	(A) Digital Wireless Weather Station	122400
	Model :NEXUS	
	Memory Functions	0
	- Stores 3000 weather records (without a computer connection) with memory saving intervals (1 hr default).	0
	- Interval: 5 Min., 10 Min., 20 Min., 30 Min., 1 Std., 1/2 Std., 2 Std., 3 Std., 4 Std., 6 Std., 24 Std	0
	(B) Digital Wireless Weather Station	114240
	Model :WS-2800	
	(C) Digital Wireless Weather Station	87040
	Model :WS-2307	
35	Digital Tong Tester	2992
36	Digital Anemometer	9520
37	Alcohol Tester	5984
38	Sound Level	8704
39	Digital Altimeter	12240
40	Digital Insulation Tester	12240
41	Infrared Moisture Meter	
	(A) 1000°C	13056
	(B) 1300°C	14960
42	Power Guard	6800
43	Digital Inclinator	14960
44	Digital Depth Gauge	10880
45	Manometer	8160
46	Digital Multimeter	680
47	Digital Multimeter Pocket Size, Multifunction, Data Hold	1360
48	<u>Stero Scope Pocket:-</u>	
	(A) Standard	544
	(B) Export	1224
49	Mirror Stero Scope in Wooden Box	3808
50	Mirror Stero Scope with 4 x Binocular	
	(A) Indian	21760
	(B) Imported	68000
51	Parallex Bar (Stereo meter)	5440
52	Instrument Box of 5 Parts	122.4
53	Instrument Box of 13 Parts	299.2
54	Mini Drafter Export Quality	204
55	Mini Drafter Export Quality Folding Type	353.6
56	Sheet Holder (Keeping the Drawing Sheet)	48.96
57	Engineer Plane Table Complete Standard	4896
58	Engineer Plane Table Complete Export	6528
59	Non Recording Rain Gauge with Measuring Jar in Fiber Body	2176
60	Digital rain gauge techno line WS-9006	32640

S.NO.	Item Name	Price Each
61	Self Recording Rain Gauge (Automatic) in Fiber Body	25840
62	<u>Freeman Tape 15 Meter</u>	
	(A) Metallic	285.6
	(B) Fiber	312.8
	(C) Steel	598.4
63	<u>Freeman Tape 30 Meter</u>	
	(A) Metallic	571.2
	(B) Fiber	625.6
	(C) Steel	870.4
64	<u>Freeman Tape 50 Meter</u>	
	(A) Metallic	924.8
	(B) Fiber	979.2
	(C) Steel	1360
65	Freeman Tape Fiber 100 Meter	2121.6
66	Freeman Measuring Wheel	4896
67	Freeman Measuring Wheel Digital	5440
68	Compressing Testing Machine Hand Operated With Calibration Chart	
	(A) 100 Tons	70720
	(B) 150 Tons	95200
	(C) 200 Tons	130560
69	Core Cutter With Rammer & Dolly	3808
70	Impact Testing Machine With Counter	14960
71	Slump Test Apparatus Complete	2448
72	Sand Replacement Method (in MM)	4216
73	<u>Sieves Made of G.I Heavy:- 125, 100, 90, 80, 75, 63, 53, 50, 45, 40, 37.5, 31.5, 26.5, 25, 22.4, 20, 19, 16, 13.2, 12.5, 11.2, 10.8, 6.3, 5.6, 4.75, & Lid & Pan</u>	
	(A) 300 MM Dia (12")	435.2
	(B) 450 MM Dia (18")	870.4
74	<u>Sieves (in MM & Microns) Made of Brass Heavy:- 10mm, 4.75, 2.36, 1.18, 600, 300, 150, 180, 425, 3.35, 710, 850, 1 MM, 2 MM& Lid & Pan.</u>	
	(A) 20 CM Dia (200MM)	707.2
	(B) 30 CM Dia (300MM)	1577.6
75	<u>Sieves Made of Brass Heavy</u>	
	<u>75 Micron & 90 Micron</u>	
	(A) 20 CM Dia (200MM)	802.4
	(B) 30 CM Dia (300MM)	1632
76	Cube Mould 15 x 15 x 15 cm	1632
77	CBR Motorized Cum Hand Operated (Complete with all Accessories)	87040
78	Marshall Stability Motorized Cum Hand Operated (Complete with all accessories)	97920
79	Diamond Core Cutter With Diesel Engine (with 100 mm Diamond Bit Complete)	212160
80	<u>Sieves Shaker :-</u> <u>Suitable for Following Sieves. Hand Operated</u>	

S.NO.	Item Name	Price Each
	(A) Suitable for 20 cm Sieves	5984
	(B) Suitable for 20 cm & 30 cm Sieves	8704
	(C) Suitable for 30 cm & 45 cm Sieves	12240
81	Dial Thermometer for Bitumen	408
82	Wood Moisture Meter (Digital)	4080
83	<u>Rapid Moisture Meter (Soil Moisture Meter)</u>	
	(A) Mechanical	7616
	(B) Digital	8160
84	<u>Vernier Calipers : 150 MM (Imported)</u>	
	(A) Mechanical	816
	(B) Digital	1904
85	<u>Micro Meter 0-25 MM (Imported)</u>	
	(A) Mechanical	816
	(B) Digital	5984
86	Electronic Balance 1 GM To 10 KG	2176
87	<u>Tent "Arctic" Nylon : (Imported)</u>	
	<u>Complete with Pole With Hanger</u>	
	(A) Single Person	5984
	(B) Two Person	9520
	(C) Five Person	14960
	(D) Eight Person	25840
	(E) Ten Persons	32640
	(F) Fifteen Persons	48960
88	<u>Ruck Sack : (Imported)</u>	
	(A) USA Pattern	3808
	(B) Modi Field / Cammo	5440
	(C) Alpine	7072
	(D) Hercules / Casual	8160
89	Life Jacket : (Imported)	2584
90	<u>Sleeping Bag : (Imported)</u>	
	(A) Standard Pattern	2584
	(B) Mummy/ Quilt Pattern	4352
	(C) D.L. Pattern	4896
	(D) Chen (Double) Pattern	5984
91	Jacket Reversible : (Imported)	4352
	Naga/ Cammo/ On 21/ Para Pattern	
92	Jacket Wind Proof : (Imported)	2176
	Cammo/ GT Pattern	
93	Pounchoos	1632
94	Shoes: DMSF/ DMSL/ Para Pattern	2992
	<u>Cap:</u>	
	(A) Field	408
	(B) Balcalava / Barray	544

S.NO.	Item Name	Price Each
95	Gloves : Imported	952
96	MICROPROCESSOR BASED PH/TEMP./MV METER	23392
97	DIGITAL PH METER WITH MANUAL TEMP.COMPENSATION	7344
98	DIGITAL PH METER,COND.AND TEPM.METER	16864
99	DELUX PH METER WITH AUTOMATIC TEMP.COMPANSTION	8704
100	DIGITAL PH,COND.&TDS METER	17136
101	DIGITAL PHOTO COLORIMETER&FILTERS	7616
102	AUTO PHOTO COLORIMETER 8 FILTERS	10880
103	DIGITAL HEMOGLOBIN METER	12240
104	MICROPROCESSOR BASEDCOND.,TDS&TEMP.METER	23120
106	DIGITAL TDS METER	8704
107	DIGITAL SALINITY METER	10880
108	DIGITAL COLONY COUNTER	5984
109	DIGITAL TURBIDITY METER	10880
110	DIGITAL NEPHELOMETER	14144
111	AUTO KARI FISHER TITRIMETER	26112
112	MICROPROCESSOR BASED D.O METER	23120
113	DIGITAL DISSOLVED OXYGEN	10880
114	MICROPROCESSOR BASED WATER&SOIL ANALYSIS KIT(7PERAMETER)	7888
115	MICROPROCESSOR BASED(8PERAMETER)	8432
116	DIGITAL WATER &SOIL ANALY.KIT(9 PERAMETER)	55760
117	DIGITAL WATER &SOIL ANALY.KIT(8 PERAMETER)	27200
118	DIGITAL WATER&SOIL ANALY.KIT(7 PERAMETER)	21760
119	DIGITAL WATER&SOIL ANALY.KIT(6 PERAMETER)	20400
120	WATER AND SOIL ANALYSIS KIT (5 PERMETER)	18496
121	DIGITAL SPECTROPHOT OMENTER(SINGLE DISPLAY)	37536
122	DIGITAL SPECTROPHOTOMETER(DOUBLE DISPLAY)	48960
123	MICROPROCESSOR SPECTROPHOTOMETER(VIS)SINGLE BEAM(IMPOTED)	81600
124	MICROPRO.BASED COND.,TDS&TEMP.METER	23392
125	DELUX CONDUCTIVITY METER	14144
126	DIGITAL CONDUCTIVITY METER	8704
127	MICROPROC.BASEDDIGITAL FLAME PHOTOMETER	112880
128	DIGITAL FLAME PHOTOMETER WITH FILTER	43520
129	DIGITAL CLINICAL FLAME PHOTOMETER	58480
130	DIGITAL TELE THERMOMETER 6 CHANNELS WITH 6 VETERINARY PROBS	14144
131	AUTOMATIC MELTING POINT APPARATUS	58480
132	DIGITAL MELTING POINT APPARATUS	39440
133	DOUBLE BEAM MICROPROC.UV_VIS SPECTROPHOTOMETER	59840
134	DOUBLE BEAM MICROPROC.UV-VIS SPECTROPHOTOMETER	65280
135	MICROPROC.UV-VIS SPECTROPHOTOMETER(SINGLE BEAM,ASSEMBLED WITH IMPORTED)	231200

S.NO.	Item Name	Price Each
136	MICROPROC.UV-VIS SPECTROPHOTOMETER(SINGLE BEAM,ADVANCE MODEL))	285600
137	MICROPROC.UV-VIS SPECTROPHOTOMETER(SINGLE BEAM,INDIA MODEL)	228480
138	DIGITAL VISCOMETER	285600
139	DOMESTIC ADVANCED DIGITAL CIRCUIT	402560
140	DIGITAL FRIABILITY TEST APPARTUS(SINGLE DRUM)	23936
141	<u>Micro Scopes (SciBio)</u>	
	(A) DISSECTING MICROSCOPE BEKALITE	816
	(B) DISSECTING MICROSCOPE BRASS	1360
	(C) SINGLE NOSE MICROSCOPE	1360
	(D) STUDENT MICROSCOPE	2992
	(E) JUNIOR MICROSCOPE	3264
	(F) STUDENT MICROSCOPE ISI	4352
	(G) STUDENT MICROSCOPE ISI	4624
	(H) JUNIOR MEDICAL MICROSCOPE ISI	4896
	(I) STERO MICROSCOPE	5440
	(J) TRAVELLING MICROSCOPE	7072
	(K) MEDICAL MICROSCOPE	7072
	(L) NEWTON RING MICROSCOPE	7616
	(M) PATHOLOGICAL MICROSCOPE ISI	8160
	(N) INCLIND MICROSCOPE	11424
	(O) PROJECTION MICROSCOPE	11968
	(P) BINOCULAR MICROSCOPE	13056
	(Q) MONOCULAR INCLINED RESEARCH MICROSCOPE ISI	14960
	(R) BINOCULAR RESEARCH MICROSCOPE ISI	17680
	(S) STERO MICROSCOPE DUAL LIGHT	19584
	(T) CO-AXIAL BINOCULAR MICROSCOPE	19584
	(U) CO-AXIAL RESEARCH MONOCULAR INCLIND MICROSCOPE ISI	21216
	(V) CO-AXIAL BINOCULAR MICROSCOPE ISI	24480
	(W) TRINOCULAR RESEARCH MICROSCOPE ISI	28560
	(X) CO-AXIAL TRINOCULAR RESEARCH MICROSCOPE ISI	35360
	<u>BATTERY FOR ALL TOTAL STATION LIECA, TOPCON, TRIMBLE, NIKON, SOKKIA, LABLINE & SciBio ETC.</u>	
142	LEICA GEB111 (TPS400, 700, 800)	15776
143	LEICA GEB121 (TPS400, 700, 800, 1100 Series)	19312
144	LEICA GEB212 (ATX1200/GPS1200/GRX1200/TC1200/TPS1200)	19312
145	LEICA GEB211 (TPS400, 700, 800, 1200 Series)	17680
146	LEICA GEB221 (TPS400, 700, 800, 1200 Series & GPS 1200)	22304
147	LEICA GEB70 (TPS100, TCA1800, TC2003)	54944
148	LEICA GEB77 (TPS1000, TPS100, TCA1800, TC2003 Series)	22304
149	LEICA GEB171 (TPS1000, TCA1800)	69360
150	LEICA GEB187 (TPS1000 & 2000 Series)	29920
151	TOPCON BDC70 (CX/RX-350)	25568
152	TOPCON BT-24Q (GTS-300/700 Series)	69360

S.NO.	Item Name	Price Each
153	TOPCON BT-32Q (GTS-220/210/200/GPT-1003)	17680
154	TOPCON BT-50Q (GTS600 Series)	32640
155	TOPCON BT-52QA (100)	19312
156	TOPCON BT-52L (GTS-330/3000)	29920
157	TOPCON BT-G1 (100 & GTS-102N)	19312
158	TOPCON BT-65Q (GTS-900)	21760
159	TOPCON BT-66Q (GTS-900)	19040
160	TOPCON TBB-2 (100)	19040
161	TOPCON TBB-2R (GTS-102N)	19040
162	TOPCON 24-030001-01 (Hiper, Gps Battery, Hiper Pro)	136000
163	Trimble 54344 (GPS5700)	16320
164	Trimble 8900084XXQ (M3 DR235)	48960
165	Trimble M3 (M3)	32096
166	Trimble TSCE	15776
167	Nikon BC-65 (DTM-300, 400, NPR-300)	27200
168	Nikon BC-80 (DTM-500)	69360
169	Nikon 67201-01-SPN (NIVO M/C)	32640
170	Sokkia BDC25 (Set BC5)	20400
171	Sokkia BDC35 (Set 030R, 130R, 2100, 22D)	25840
172	Sokkia BDC58 (Set Series/STRATUS L1 GPS/RCA)	21760
173	Sokkia TBB-2S/BT-G1 (GTS-105/Set02N)	19312
174	Sokkia BDC70 (CX/RX-350)	25840
175	Sokkia BDC46A Sokkia BDC46 (Set10K, 30R) SokkiaBDC46B	13600
176	South NB-20 (NTS-30 Series)	15776
177	South NB-10 (DT Series)	12240
178	South NB-28 (NTS-30 Series)	15776
179	South S82 (GPS)	15776
180	South WA3004 (7527C/7525C)	15776
181	South 730 (S730)	20400
182	Lab line BE-256, 286, 286 R	17680
183	SciBio AL-215, AL-212, AL-212 RC, AL-212 RCW	23120
184	<u>CHARGER FOR ALL TOTAL STATION LIECA, TOPCON, TRIMBLE, NIKON, SOKKIA, LABLINE & SciBio ETC.</u>	
185	Universal Testing Machine (UTM) Digital Operated (SciBio) Capacity: (A) 10 Tons (B) 20 Tons (C) 40 Tons	408000 663000 969000
186	Compression Testing Machine Complete With Calibration Report (Hand Operated) (SciBio) Capacity: (A) 100 Tons	59925

S.NO.	Item Name	Price Each
	(B) 150 Tons	81600
	(C) 200 Tons	119850
187	Compression Testing Machine Complete With Calibration Report (Digital Operated) (SciBio)	
	(A) Capacity 100 Tons	140250
	(B) Capacity 150 Tons	165750
	(C) Capacity 200 Tons	193800
188	Vicat Needle Apparatus Complete Set Packed In Box	3570
189	Concrete Test Hammer Packed In Box	
	(A) Indian	8925
	(B) Imported (SciBio)	17850
190	Flash And Fire Test Apparatus	6375
191	Tar Viscometer Complete Set	10710
192	Softening Point Test Apparatus	10200
193	Pycnometer Bottle	637.5
194	Soil Permeability Test Apparatus Complete Set	24225
195	Standard Penetrometer Hand Operated	8925
196	Standard Penetrometer Electric Operated	21675
197	Vane Shear Apparatus Electric Operated	34425
198	Ductility Test Apparatus Complete Set	62475
199	Specific gravity apparatus (buoyancy balance)	39525
200	Vibrating table size- 20"	30600
201	Crushing value apparatus 150mm	8160
202	Density basket	1657.5
203	Blain air permeability apparatus	3952.5
204	Rammer for core cutter	3442.5
205	Bulk And Density Set 3,15,30 Ltr	10200
206	Aggregate Impact Test Apparatus	11475
207	Liquid Limit Device	3697.5
208	Gauging Trowel	561
209	Los Angles Test Apparatus Complete Set (Full Body)	89250
210	Bitumen Extractor Hand Operated	11730
211	Bitumen Extractor Electrical Operated	28050
212	Sieves Brass 8" - 75 Mic And 90 Mic (Special No.)	841.5
213	Motorized sieve shaker 8" dia	31875
214	Sieves Good Quality	
	(A) Brass 8"	714
	(B) GI 12"	433.5
	(C) GI 18"	816
215	Enorsand Bag	2167.5
216	Proctor Mould And Rammer 2.6 Kg	3952.5
217	Proctor Mould And Rammer 4.89 Kg	5100
218	Slump Test Apparatus Complete Set	

S.NO.	Item Name	Price Each
	(A) Standard	2167.5
	(B) As per IS	2805
219	Vee bee consistometer - motorised	30600
220	Marshal stability machine complete with all standard accessories	89250
221	Diamond core drilling machine 5 H.P. petrol operated	165750
222	Portable core drilling machine electrically operated	42075
223	Compressometer	16575
224	CBR machine single speed complete with all standard accessories	86700
225	Tile abrasion testing machine complete	91800
226	Extensometer	16575
227	Dynamic Cone Penetrometer Complete Set	16575
228	Rapid Moisture Meter Packed In Wooden Box	4972.5
229	Compaction Factor Apparatus Complete Set	20400
230	Vibrating Machine Good Quality	39525
231	Consolidation Test Apparatus Complete Set	57375
232	Direct Shear Test Apparatus Complete Set With Proving Ring And Dial Gauge	91800
233	Dolly Cutter	816
234	Length Gauge And Thickness Gauge Set	1224
	Sand Replacement Apparatus	
	(A) 100 Mm Dia	2677.5
	(B) 150 Mm Dia	5610
	(C) 200 Mm Dia	8670
235	Cube Mould	
	(A) 50x50x50mm	726.75
	(B) 70.6x70.6x70.6mm	841.5
	(C) 100x100x100mm	1224
236	(D) 150x150x150mm	1504.5
237	Lab Concrete Mixer	66300
238	Penskey Martin Flash & Fire	14790
239	Redwood Viscometer	14025
240	Say Volt Viscometer	14025
241	Reagent For Moisture Meter (Carbide Chemical)	204
242	Plastic Limit Device	1657.5
243	Shrinkage Limit	2167.5
244	Mortar Mixer For Bitumen Test	81600
245	DLC Hammer Machine	58650
	Unconfined Compression Testing Machine	
	(A) Hand Operated	73950
246	(B) Motorized	96900
247	Triaxial Testing Machine Complete With All Standard	132600
248	Air Entertainment Meter	29325
	Beam Mould	
	(A) 100x100x500mm	4590

S.NO.	Item Name	Price Each
249	(B) 150x150x700mm	6885

Chemistry Lab Consumables Price List

Cat No.	Description	Price ₹
BEAKER Graduated, Low Form		
SC-1A	10 ml	65
SC-1B	25 ml	71
SC-1C	50 ml	88
SC-1D	100 ml	105
SC-1E	150 ml	122
SC-1F	250 ml	190
SC-1G	400 ml	272
SC-1H	500 ml	330
SC-1H1	1000 ml	697
SC-1H2	2000 ml	
BEAKER Graduated, TALL FORM		
SC-2A	10 ml	65
SC-2B	25 ml	71
SC-2C	50 ml	95
SC-2D	100 ml	116
SC-2E	150 ml	150
SC-2F	250 ML	207
SC-2G	400 ML	303
SC-2H	500 ML	374
SC-2H1	1000 ML	823
B.O.D.BOTTLE		
SC-3A	125 ML	534
SC-3B	300 ML	779
BURETTE with Pinch Cork		
SC-4A	25 ML	150
SC-4B	50 ML	177
SC-4C	100 ML	262
BURETTE with straight GLASS stopcock		
SC-5A	10 ml	3743
SC-5B	25 ml	374
SC-5C	50ml	425
SC-5D	100 ML	507
BURETTE SCREW Rota Flow Stopcock		
SC-6A	10 ML	286
SC-6B	25 ML	313
SC-6C	50 ML	374
SC-6D	100 ML	452
CENTRIFUGAL TUBE PLAIN,		
SC-7A	10 ML	41
SC-7B	15 ml	58
SC-7C	25 ML	102
SC-7D	50 ML	180
CENTRIFUGAL TUBE GRADUATED		
SC-8A	10 ML	58
SC-8B	15 ML	75
SC-8C	25 ML	122
SC-8D	50 ML	221
CENTRIFUGAL TUBE WITH SCREW CAP		

Cat No.	Description	Price ₹
SC-9A	10 ML	109
SC-9B	15 ML	122
SC-9B	25 ML	197
CONDENSER LIE BIG plain		
SC-10A	200 mm	493
SC-10B	300 MM	598
SC-10C	400 MM	656
SC-10D	500 MM	864
CONDENSER LIE BIG with I/C Joint		
SC-11A	200 MM	619
SC-11B	300 MM	697
SC-11C	400 MM	904
CONDENSER ALLIHN with I/C Joint		
SC-12A	200 MM	738
SC-12B	300 MM	904
SC-12C	400 MM	1149
DISTILLATION FLASK R.B. side tube		
SC-22A	50 ML	197
SC-22B	100 ML	221
SC-22C	250 ML	289
SC-22D	500 ML	411
SC-22E	1000 ML	823
DISTILLATION APPARATUS Automatic		
SC-23A	3000 ML	34558
SC-23B	5000 ML	41140
SC-23C	10000 ml	65824
SC-24A	Automatic Cut Off Device For Above	8639
DISTILLATION SET		
SC-25A	250 ML	18102
SC-25B	500 ML	1972
SC-25C	1000 ML	2383
DROPPING BOTTLE with pipette stopper		
SC-26A	30 ML	343
SC-26B	60 ML	374
SC-26C	125 ML	411
SC-26D	250 ML	493
R.D.BOTTLE with glass stopper		
SC-27A	10 ml	245
SC-27B	25 ml	262
SC-27C	50 ml	303
FILTER FLASK PLAIN 'heavy filtration		
SC-28A	250 ML	534
SC-28B	500 ML	697
SC-28C	1000 ML	1397
FLAT BOTTOM FLASK		
SC-29A	5/10 ML	99
SC-29B	25 ML	122
SC-29C	50 ML	139

Cat No.	Description	Price ₹
SC-29D	100 ML	153
SC-29E	250 ML	214
SC-29F	500 ML	337
SC-29G	1000 ML	697
SC-29H	2000 ML	1397
SC-29I	3000 ML	2880
SC-29J	5000 ML	5348
FLAT BOTTOM FLASK Joint B 24/29		
SC-30A	5/10 ML	146
SC-30B	25 ML	180
SC-30C	50 ML	207
SC-30D	100 ML	221
SC-30E	250 ML	289
SC-30F	500 ML	411
SC-30G	1000 ML	823
SC-30H	2000 ML	1564
SC-30I	3000 ML	3084
SC-30J	5000 ML	5760
FUNNEL		
SC-31A	50 mm	92
SC-31B	65 mm	109
SC-31C	75 mm	122
SC-31D	100 MM	238
SC-31E	125 mm	534
SC-31F	150 MM	779
FUNNEL BUCKNER WITH Sintered Disc		
SC-32A	G-1/G-2/G-3/G-4/G-5	
SC-32B	35 ML	534
SC-32C	80 ML	1027
SC-32D	200 ML	2261
SC-32E	500 ML	4937
SC-32E	1000 ML	9874
SC-33A	FOLIN TUBE BLOOD SUGAR TUBE	150
GOOCH CRUCIBLE G-1/G-2/G-3/G-4/G-5		
SC-34A	30 ML	313
SC-34B	50 ML	507
REAGENT BOTTLE N. M, AMBER COLOR		
SC-47A	60 ML	473
SC-47B	125 ML	615
SC-47C	250 ML	751
SC-47D	500 ML	1068
SC-47E	1000 ML	1727
SC-47F	2000 ML	3291
REFLUXE ASSEMBLY		
SC-48A	250 ML	1068
SC-48B	500 ML	1234
ROUND BOTTOM FLASK		
SC-49A	5/10 ML	1010
SC-49B	25 ML	1085
SC-49C	50 ML	1384
SC-49D	100 ML	156
SC-49E	250 ML	231
SC-49F	500 ML	337
SC-49G	1000 ML	697

Cat No.	Description	Price ₹
SC-49H	2000 ML	1397
SC-49I	3000 ML	2880
SC-49J	5000 ML	5348
SC-49K	10000 ML	11353
SC-49L	20000 ml	28798
ROUND BOTTOM FLASK Joint B 24/29,		
SC-501	5/10 ML	150
SC-502	25 ML	180
SC-503	50 ML	204
SC-504	100 ML	221
SC-505	250 ml	289
SC-506	500 ML	411
SC-507	1000 ML	823
SC-508	2000 ML	1564
SC-509	3000 ML	3084
SC-510	5000 ML	5760
SC-511	10000 ML	12753
SC-512	20000 ML	31266
ROUND BOTTOM FLASK, TWO NECK		
SC-514	100 ML	384
SC-515	250 ML	493
SC-516	500 ML	721
SC-517	1000 ML	1275
SC-518	2000 ML	2179
SC-519	3000 ML	3703
SC-520	5000 ML	7405
ROUND BOTTOM FLASK, THREE NECK		
SC-522	100 ML	554
SC-523	250 ML	673
SC-524	500 ML	986
SC-525	1000 ML	1768
SC-526	2000 ML	2795
SC-527	3000 ML	4525
SC-528	5000 ML	8639
SEPARATING FUNNEL PTFE Rota Flow Stop Cock		
SC-530	60 ML	391
SC-531	125 ML	452
SC-532	250 ML	575
SC-533	500 ML	864
SC-534	1000 ML	1397
SC-535	2000 ML	2057
SOXLETTE EXTRACTION APPARATUS		
SC-537	60 ML	1809
SC-538	100 ML	1972
SC-539	200 ML	3291
SC-540	400 ML	7817
CONDENSOR GRAHAM Coil Type I/C Joint		
SC-542	200 MM	823
SC-543	300 MM	1197
SC-544	400 MM	1149
CONDENSER DOUBLE SURFACE		
SC-546	200 MM	1479
SC-547	300 MM	1727

Cat No.	Description	Price ₹
SC-548	400 MM	2057
CONICAL FLASK		
SC-550	5/10 ML	102
SC-551	25 ML	122
SC-552	50 ML	143
SC-553	100 ML	156
SC-554	250 ML	214
SC-555	500 ML	337
SC-556	1000 ML	697
SC-557	2000 ML	1397
SC-558	3000 ML	2880
SC-559	5000 ML	5348
CONICAL FLASK WIDE MOUTH		
SC-561	5/10 ML	102
SC-562	25 ML	129
SC-563	50 ML	156
SC-564	100 ML	177
SC-565	250 ML	262
SC-566	500 ML	377
SC-567	1000 ML	823
SC-568	2000 ML	1601
SC-569	3000 ML	3084
SC-570	5000 ML	5760
CONICAL FLASK with Joint B 24/29,		
SC-572	5/10 ML	150
SC-573	25 ML	139
SC-574	50 ML	204
SC-575	100 ML	224
SC-576	250 ML	286
SC-577	500 ML	411
SC-578	1000 ML	823
SC-579	2000 ML	1561
SC-580	3000 ML	3084
SC-581	5000 ML	5760
CONICAL FLASK with screw cap		
SC-583	50 ML	343
SC-584	100 ML	374
SC-585	250 ML	452
SC-586	500 ML	656
SC-587	1000 ML	1234
SC-588	2000 ML	2179
CULTURE TUBE MEDIA with screw cap & RUBBER liner Round / Flat bottom		
SC-590	5 ml 15X75	54
SC-591	10 ML 15X125	71
SC-592	15 ML 15X150	78
SC-593	25 ML 18X150	95
SC-594	30 ml 25X100	102
SC-595	50 ML 25X150	119
SC-596	60 ml 25X200	150
DESICCATORS PLAIN		
SC-598	100 MM	3291
SC-599	150 MM	4070
SC-600	200 MM	7198
SC-601	240 MM	10900

Cat No.	Description	Price ₹
SC-602	300 MM	20815
DESICCATORS VACUUM		
SC-604	150 MM	6786
SC-605	200 MM	9462
SC-606	240 MM	14685
SC-607	300 MM	28387
IODINE FLASK		
SC-609	100 ML	374
SC-610	250 ML	473
SC-611	500 ML	697
SC-612	1000 ML	1149
KIPPS APPARATUS		
SC-614	250 ML	5348
SC-615	500 ML	7817
SC-616	1000 ML	11108
MEASURING CYLINDERS Round Base		
SC-618	5 ML	133
SC-619	10 ML	153
SC-620	25 ML	184
SC-621	50 ML	224
SC-622	100 ML	330
SC-623	250 ML	575
SC-624	500 ML	823
SC-625	1000 ML	1479
SC-626	2000 ML	3206
MEASURING CYLINDERS Hexag Base		
SC-628	5 ML	452
SC-629	10 ML	534
SC-630	25 ML	615
SC-631	50 ML	680
SC-632	100 ML	796
SC-633	250 ML	1438
SC-634	500 ML	1907
SC-635	1000 ML	2880
SC-636	2000 ML	5348
MEASURING CYLINDERS I/C Stopperd		
SC-638	5 ML	228
SC-639	10 ML	133
SC-640	25 ML	286
SC-641	50 ML	343
SC-642	100 ML	493
SC-643	250 ML	697
SC-644	500 ML	986
SC-645	1000 ML	1809
SC-646	2000 ML	3703
NESSLERS CYLINDER		
SC-648	50 ML	102
SC-649	100 ML	146
PETRI DISH		
SC-651	50 mm	269
SC-652	75 mm	309
SC-653	100 MM	343
PIPETTE GRADUATED		
SC-655	Form 0.1 ml up to 10 ML	99

Cat No.	Description	Price ₹
SC-656	20/25 ML	167
PIPETTE VOLUMETRIC		
SC-658	1 ml/ 2 ml	68
SC-659	5 ML / 10 ML	102
SC-660	20 ml / 25 ML	122
SC-661	50 ML	214
SC-662	100 ML	262
REAGENT BOTTLE Narrow Mouth		
SC-664	60 ML	313
SC-665	125 ML	391
SC-666	250 ML	507
SC-667	500 ML	738
SC-668	1000 ML	1275
SC-669	2000 ML	2302
REAGENT BOTTLE Wide Mouth		
SC-671	60 ML	394
SC-672	125 ML	493
SC-673	250 ML	615
SC-674	500 ML	904
SC-675	1000 ML	1561
SC-676	2000 ML	2550
REAGENT BOTTLE W. M. screw cap		
SC-678	60 ML	411
SC-679	125 ML	473
SC-680	250 ML	697
SC-681	500 ML	904
SC-682	1000 ML	1727
SC-683	2000 ML	2672
TEST TUBE STOPPER WITH JOINT		
SC-685	10 x 75 mm	75
SC-686	10 x 100 mm	82
SC-687	12 x 100 mm	85
SC-688	15 x 125 mm	109
SC-689	15 x 150 mm	116
SC-690	18 x 150 mm	122
SC-691	25 x 150 mm	156
TEST TUBE pigeon hole pack		
SC-693	10 x 75 mm	58
SC-694	10 x 100 mm	6
SC-695	12 x 100 mm	6
SC-696	15 x 125 mm	9
SC-697	15 x 150 mm	14
SC-698	18 x 150 mm	13
SC-699	25 x 150 mm	21
TEST TUBE BOROSILICATE glass		
SC-701	10 x 75 mm	11
SC-702	10 x 100 mm	13
SC-703	12 x 100 mm	15
SC-704	15 x 125 mm	
SC-705	15 x 150 mm	33
SC-706	18 x 150 mm	41
SC-707	25 x 150 mm	48
TEST TUBE GRADUATED		
SC-709	10 x 75 mm	33
SC-710	10 x 100 mm	39

Cat No.	Description	Price ₹
SC-711	12 x 100 mm	41
SC-712	15 x 125 mm	41
SC-713	15 x 150 mm	49
SC-714	18 x 150 mm	65
SC-715	25 x 150 mm	82
THISTLE FUNNEL		
SC-717	CUP TYPE	71
SC-718	BULB TYPE	92
SC-719	VICTOR MEYERS APPARATUS	2672
SC-720	VISCOMETER	146
VOLUMETRIC FLASK Solid Stopper		
SC-722	5 ML	180
SC-723	10 ML	184
SC-724	25 ML	197
SC-725	50 ML	235
SC-726	100 ML	272
SC-727	250 ML	354
SC-728	500 ML	639
SC-729	1000 ML	864
SC-730	2000 ML	2057
SC-731	5000 ML	6171
WEIGHING BOTTLE tall form		
SC-733	25 x 60 mm	156
SC-734	30 x 65 MM	224
SC-735	40 x 90 mm	493
WEIGHING BOTTLE squat form		
SC-737	50 x 25 mm	534
SC-738	50 x 30 mm	575
SC-739	60 x 30 MM	700
SODA LIME GLASSEWARE		
Aspirator Bottle with Outlet for Stopper on side size ltrs		
SC-744	1	765
SC-745	2	765
SC-746	2.5	765
SC-747	3	1445
SC-748	5	3145
SC-749	10	
A.P. Bottle (Pneumothorax Bottle)		
SC-752	1100 ml graduated	279
SC-753	2000ml graduated	432
Beaker Griffin Low From		
SC-755	25ml	167
SC-756	50ml	167
SC-757	100ml	167
SC-758	150ml	167
SC-759	250ml	167
SC-760	400ml	167
SC-761	500ml	167
SC-762	600ml	167
SC-763	1000ml	279
SC-764	2000ml	417
Winchester Bottle		
SC-766	2000ml	680

Cat No.	Description	Price ₹
SC-767	2500ml	850
SC-768	3000ml	1020
SC-769	5000ml	1190
SC-770	7500ml	1360
SC-771	10000ml	1530
SC-772	15000ml	2550
SC-773	20000ml	4760
SC-774	25000ml	5950
SC-775	30000ml	7650
Woulf Bottles		
SC-777	250ml	1445
SC-778	500ml	1445
Beaker Low Form Graduated (Screen Printed)		
SC-781	25ml	197
SC-782	50ml	197
SC-783	100ml	197
SC-784	150ml	197
SC-785	250ml	197
SC-786	500ml	197
SC-787	1000ml	197
SC-788	2000ml	435
Battery Jars (Dia.xHt. Cm)		
SC-791	15x10	262
SC-792	20x15	425
Bell Jars with Knob & Ground Rim (Closed at top)(Dia.xHt. Cm)		
SC-796	10x20	850
SC-797	15x22.5	850
SC-798	16x10	5950
SC-799	18x10	7650
Bell Jars with stopper on Top and Ground Rim(Open at top)(Dia.xHt. Cm)		
SC-802	10x20	595
SC-803	15x22.5	765
SC-804	16x10	4913
SC-805	18x10	7140
Bell Jar Knobbed(Dia.xHt. Cm)		
SC-807	8x4	850
SC-808	9x6	850
SC-809	16x10	5950
SC-810	18x10	7650
Bottle Gas Washing Dreschel (plain)		
SC-812	250ml	289
Burette with pinch clip complete with rubber tube and jets		
SC-815	25ml	218
SC-816	50ml	315
SC-817	100ml	389
Burette with stopcock		
Please refer to item numbers 5,6 & 7 in Borosilicate glass ware		
Section for Burettes with stopcock in various models and sizes		
SC-821	Breast Pump	425

Cat No.	Description	Price ₹
Crystallizing Dishes Flat Bottom (size in cm)		
SC-824	7.5	765
SC-825	10	765
Canada balsam Bottle with Glass Rod		
SC-828	30ml	245
SC-829	60ml	425
SC-830	12.Cup Volta Meter	252
SC-831	6" Voltameter Cup	313
Calcium Chloride Tower		
SC-834	125ml	425
SC-835	250ml	425
Cavity Block Size mm		
SC-838	40x40	218
SC-839	55x55	228
Coupling jar		
SC-841	For 5 to 10 slide (small)	306
SC-842	For 10 to 20 slide (big)	459
Bottle with Rubber teat and glass dropper(ml)		
SC-845	30ml	111
SC-846	60ml	111
SC-847	125ml	111
SC-848	250ml	425
Dropping Bottle with glass stopper (TKPattern)		
SC-851	30ml	231
SC-852	60ml	247
SC-853	125ml	265
Dropping Bottle with Glass Stopper (T.Kpattern,)Amber colour		
SC-856	30ml	296
SC-857	60ml	313
SC-858	125ml	425
Desicators with Cover		
SC-860	4"	765
SC-861	5"	765
SC-862	6"	2788
SC-863	8"	3740
SC-864	10"	4760
SC-865	12"	5610
Desiccators Pyrex Type Vacuum		
SC-868	10cm	604
SC-869	15cm	986
SC-870	20cm	3332
SC-871	25cm	4250
Desiccators Pyrex Type Vacuum		
SC-874	15cm	4301
SC-875	20cm	4845
SC-876	25cm	5950
Erlenmeyer Flasks Narrow Mouth Conical)		
SC-879	50ml	189
SC-880	100ml	189
SC-881	150ml	189
SC-882	250ml	189

Cat No.	Description	Price ₹
SC-883	500ml	189
SC-884	1000ml	189
Erlenmeyer Flask Narrow Mouth Conical (screen Printed)		
SC-887	50ml	189
SC-888	100ml	189
SC-889	250ml	189
SC-890	500ml	189
SC-891	1000ml	189
Flask Flat Bottom		
SC-894	100ml	189
SC-895	150ml	189
SC-896	250ml	189
SC-897	500ml	189
SC-898	1000ml	189
Flask flat bottam (printed)		
SC-900	10ml	189
SC-901	250ml	189
SC-902	500ml	189
SC-903	1000ml	189
Flask Round Bottom		
SC-905	100ml	189
SC-906	150ml	189
SC-907	250ml	189
SC-908	500ml	189
SC-909	1000ml	189
Flask R.B. Long Neck (Retorted)		
SC-911	100ml	189
SC-912	250ml	189
SC-913	500ml	189
Flask Round Bottam (printed)		
SC-915	100ml	189
SC-916	250ml	189
SC-917	500ml	189
SC-918	1000ml	189
Flask conical		
SC-920	50ml	189
SC-921	100ml	189
SC-922	150ml	189
SC-923	250ml	189
SC-924	500ml	189
SC-925	1000ml	189
SC-926	2000ml	595
Flask conical (graduated with screen Printing)		
SC-928	50ml	189
SC-929	100ml	189
SC-930	150ml	189
SC-931	250ml	189
SC-932	500ml	189
SC-933	1000ml	189
SC-934	2000ml	425
Flask iodine		
SC-936	250ml	189
SC-937	500ml	189

Cat No.	Description	Price ₹
Flask Filtering with tabulature at side heavy wall		
SC-940	100ml	189
SC-941	250ml	189
SC-942	500ml	359
SC-943	1000ml	529
Flask Volumetric Stopper (Measuring/standard Flask)		
SC-946	50ml	189
SC-947	100ml	189
SC-948	250ml	189
SC-949	500ml	189
SC-950	1000ml	425
SC-951	2000ml	595
Gold Leaf Jar		
SC-954	Glass jar only	189
Funnel 60 Angle Plain dia cm		
SC-957	2"	189
SC-958	2.5"	189
SC-959	3"	189
SC-960	4"	189
SC-961	5"	189
SC-962	6"	189
SC-963	8"	425
Gas Generating Apparatus kippis		
SC-965	250ml	2040
SC-966	500ml	2550
SC-967	1000ml	3060
SC-968	Gold leaf jar	189
Gas jars with Ground Flang and foot without lid Dia.xHt.cm		
SC-971	10x3.15 (4.15)	189
SC-972	15x5 (6x2)	189
SC-973	20x5 (8x2)	189
SC-974	25x5 (10x2)	189
SC-975	30x5 (12x12)	342
SC-976	7.5x20 (8x3)	342
SC-977	7.5x25 (10x3)	491
SC-978	7.5x30 (12x3)	595
SC-979	7.5x37.5 (15x3)	595
SC-980	10x15 (6x4)	595
SC-981	10x20 (8x4)	595
SC-982	10x25 (10x4)	646
SC-983	10x30 (12x4)	765
SC-984	10x37.5 (15x4)	850
SC-985	15x20 (8x6)	1020
SC-986	30x15 (12x6)	1190
SC-987	37.5x15 (15x6)	1360
Gas Washing Bottle without Fitting		
SC-990	25ml	189
Gas Generating Kips Apparatus complete with Delivery tube and thistle funnel		
SC-993	250ml	1615
SC-994	500ml	2040
SC-995	1000ml	2550

Cat No.	Description	Price ₹
	Spare thistle funnel & fitting only	332
Hydrometer jars		
SC-998	25ml	189
SC-999	50ml	189
SC-1000	100ml	189
SC-1001	250ml	189
SC-1002	500ml	189
SC-1003	1000ml	445
SC-1004	2000ml	680
Iodine Flask Stoppered		
SC-1007	250ml	189
SC-1008	500ml	213
Jars coplin with Cover		
SC-1011	5/10 slide	189
SC-1012	Jars Staining Rectangular with cover	476
Lachlanche cell post		
SC-1015	2 Pints	432
SC-1016	3 Pints	510
Medicine Glass Graduated		
SC-1019	10ml	189
SC-1020	25ml	189
SC-1021	50ml	189
SC-1022	100ml	189
SC-1023	200ml	189
SC-1024	500ml	189
Mortars And Pestles Diameter cm		
SC-1027	6cm	189
SC-1028	9cm	189
SC-1029	11.5cm	425
SC-1030	15cm	595
39.Measuring cylinders Graduated Size ml.		
SC-1033	5ml	189
SC-1034	10ml	189
SC-1035	25ml	189
SC-1036	50ml	189
SC-1037	100ml	189
SC-1038	250ml	189
SC-1039	500ml	425
SC-1040	1000ml	425
SC-1041	2000ml	663
Measuring cylinder (Screen Printed)		
SC-1043	25ml	189
SC-1044	50ml	189
SC-1045	100ml	189
SC-1046	250ml	189
SC-1047	500ml	425
SC-1048	1000ml	425
SC-1049	2000ml	765
Media Bottle complete with aluminum cap and Rubber washer		
SC-1052	7ml	189

Cat No.	Description	Price ₹
SC-1053	15ml	189
SC-1054	30ml	189
SC-1055	30ml long	189
SC-1056	30ml short	189
SC-1057	125ml	189
SC-1058	180ml	189
Urine Test Glass Graduated		
SC-1060	100ml	189
SC-1061	250ml	189
SC-1062	500ml	425
Pneumatic Trough		
SC-1064	6x4	425
SC-1065	8x4	425
SC-1066	10x4	595
SC-1067	10x5	765
SC-1068	12x4	935
SC-1069	12x5	1105
SC-1070	12x6	1445
Petri dishes		
SC-1072	5cm	189
SC-1073	7.5cm	189
SC-1074	9cm	189
SC-1075	10 cm	189
SC-1076	12.5cm	189
SC-1077	15cm	510
SC-1078	20cm	680
Pneathorax Bottles (A.P Bottle)		
SC-1080	1100ml (Graduated)	323
SC-1081	1500ml (Graduated)	595
SC-1082	2000ml(Graduated)	680
Rt Bottles N. M .F. S.		
SC-1084	30ml	189
SC-1085	60ml	189
SC-1086	125ml	189
SC-1087	250ml	189
SC-1088	500ml	425
SC-1089	1000ml	425
SC-1090	2000ml	425
SC-1091	Stand Blasting Charges	189
Rt. Bottle W.M.F.S.		
SC-1093	30ml	189
SC-1094	60ml	189
SC-1095	125ml	189
SC-1096	250ml	189
SC-1097	500ml	189
SC-1098	1000ml	425
SC-1099	2000ml	595
SC-1100	3000ml	680
Pipette Volumetric one mark (Bulb Type)		
SC-1103	5ml	
SC-1104	10ml	189
SC-1105	20ml	189
SC-1106	25ml	189
SC-1107	50ml	
44.Pipette Graduated (Mohr Type) Sizes ml		

Cat No.	Description	Price ₹
SC-1110	1.0/	60
SC-1111	2.0/	70
SC-1112	5.0/	80
SC-1113	10.0/	90
SC-1114	20.0/	100
SC-1115	25.0/	110
SC-1116	50.0/	120
Reagent bottle w.m.f.s. (Amber)		
SC-1119	125ml	189
SC-1120	250ml	425
SC-1121	500ml	476
SC-1122	1000ml	510
Reagent Bottle with Dust Proof Flat Stopper Narrow Mouth,Amber colour		
SC-1124	30ml	189
SC-1125	60ml	189
SC-1126	125ml	179
SC-1127	250ml	189
SC-1128	1000ml	377
SC-1129	2000ml	425
SC-1130	2500ml	952
SC-1131	3000ml	1360
SC-1132	4000ml	1190
Laboratory Tubes & Rods		
SC-1134	1 To 10MM	
SC-1135	Glass Beads	
Rain Gauge Cylinders Graduated		
SC-1138	12.5mm	189
SC-1139	20mm	359
SC-1140	25mm	425
Spirit lamp		
SC-1142	60MI	189
SC-1143	125ml	189
SC-1144	150ml	189
SC-1145	Sprit lamps Hexagonal	189
SC-1146	Hexagonal shape125 Brass	189
Specimen tube		
SC-1148	75x25mm	507
SC-1149	75x31	507
SC-1150	75x238mm	507
SC-1151	100x25mm	507
SC-1152	100x31mm	507
SC-1153	100x38mm	527
SC-1154	100x50mm	527
SC-1155	150x25mm	527
SC-1156	150x38mm	527
SC-1157	150x50mm	765
SC-1158	200x50mm	935
Specimen jar Round with Knobbed Stoppers with Flange Dia.xHt.cm		
SC-1161	5x15	189
SC-1162	5x20	189
SC-1163	5x25	189
SC-1164	5x30	189

Cat No.	Description	Price ₹
SC-1165	7.5x20	425
SC-1166	7.5x25	425
SC-1167	7.5x30	510
SC-1168	7.5x37.5	765
SC-1169	10x15	765
SC-1170	10x20	765
SC-1171	10x25	765
SC-1172	10x30	765
SC-1173	10x37.50	935
SC-1174	15x20	935
SC-1175	15x30	1275
SC-1176	15x37.5	1445
Specimen jars with Plastic caps		
SC-1178	180ml	189
SC-1179	250ml	189
SC-1180	500 ml	189
SC-1181	1000ml	357
SC-1182	1500ml	357
Specimen jars with knobbed stopper		
SC-1184	10x3.15cm (4x1.5)	189
SC-1185	15x5cm (6x2)	189
SC-1186	20x5cm (8x2)	255
SC-1187	25x5cm (10x2)	425
SC-1188	30x5cm (12x2)	425
SC-1189	20x7.5cm (8x3)	485
SC-1190	25x7.5cm (10x3)	527
SC-1191	30x7.5cm (12x3)	655
SC-1192	37.5x7.5cm (15x3)	680
SC-1193	15x10cm (6x4)	850
SC-1194	20x10cm (8x4)	850
SC-1195	25x10 (10x4)	850
SC-1196	30x10 (12x4)	1020
SC-1197	37.5x10 (15x4)	1190
SC-1198	20x15 (8x6)	1360
SC-1199	30x15 (12x6)	1697
SC-1200	37.5x15 (15x6)	1697
Specimen jar Rectangular		
SC-1202	5x5x3	189
SC-1203	10x5x6	189
SC-1204	15x10x5	425
SC-1205	15x9x6	425
SC-1206	12x12x9	595
SC-1207	15x15x9	595
SC-1208	15x15x5	595
SC-1209	15x15x6	595
SC-1210	15x15x8	952
SC-1211	15x15x15	850
SC-1212	16x12x10	850
SC-1213	20x8x5	850
SC-1214	20x10x5	850
SC-1215	20x12x10	850
SC-1216	20x20x40	850
SC-1217	20x12x12	850
SC-1218	20x20x7	850

Cat No.	Description	Price ₹	Cat No.	Description	Price ₹
SC-1219	20x20x12	1020	SB-M24	Bandage cutting scissor 8"	425
SC-1220	20x20x16.5	1190	SB-M25	Bed pan male	1105
SC-1221	22x15x10	1190	SB-M26	Bed pan S.s. female	1105
SC-1222	26x15x10	1190	SB-M27	Bed side screen 3 fold with curtain S.s	5185
SC-1223	26x17x9	1190	SB-M28	Bed side screen 4 fold with curtain S.s	5185
SC-1224	25x17x15	1360	SB-M29	Bottle Filling Machine	65637
SC-1225	28x21x10.4	1853	SB-M30	Bottle sealing machine	60588
SC-1226	30x8x5	2550	SB-M31	Bottle washing machine	70686
SC-1227	30x15x12	2550	SB-M32	Boul S.s 10"	425
SC-1228	30x17x9	2550	SB-M33	Boul S.s 12"	425
SC-1229	25x25x12	2550	SB-M34	Boul S.s 8"	425
SC-1230	31x29x11	5950	SB-M35	Bulk Density apparatus	28274
SC-1231	45x45x15	7650	SB-M36	Bulk Density App. Digital	45441
SC-1232	30x25x20	8500	SB-M37	Capsule counter	10098
Surgical Items			SB-M38	Capsule Filling	90882
SB-M01	Artery forcep S.S. ISI mark 5"	425	SB-M39	Centrifuge machine electric 6 tube	10512
SB-M02	Activity Gage	38372	SB-M40	Centrifuge tube 25 ml	90
SB-M03	Alice tissue forcep S.S. ISI mark 10"	425	SB-M41	Centrifuge tube 15 ml	70
SB-M04	Alice tissue forcep S.S. ISI mark 8"	425	SB-M42	Cheatle forceps S.S. ISI mark 8"	425
SB-M05	Ambu bag +roller	5950	SB-M43	Cheatle forceps S.S. ISI mark 10"	425
SB-M06	Ampoule Filling & Sealing Machine Double Burner	40392	SB-M44	Clinical thermometer	425
SB-M07	Ampoule Filling & Sealing Machine Single Burner	30294	SB-M45	Coating Pan	55539
SB-M08	Ampoule Washing	15147	SB-M46	Convulso Meter	33323
SB-M09	Anemia can S.S	1105	SB-M47	D&C set	4250
SB-M10	Anemia can plastic	595	SB-M48	D.T.Machine Double Basket Digital Temp.	55539
SB-M11	Antibiotic Zone Reader	65637	SB-M49	D.T.Machine Double Basket	40392
SB-M12	Artery forcep S.S. ISI mrk 6"	425	SB-M50	D.T.Machine Double Basket Digital T.M.P. Timer with water bath	15147
SB-M13	Artery forcep S.S. ISI mrk 7"	425	SB-M51	D.T.Machine Single Basket	30294
SB-M14	Artery forcep S.S. ISI mark 8"	425	SB-M52	D.T.Machine Single Basket	28274
SB-M15	Aseptic cabinet	40392	SB-M53	D.T. Single Basket Digital Temp.	45441
SB-M16	B.P instruments Digital ISI	1445	SB-M54	Dissecting forceps S.S.5"	425
SB-M17	B.P instruments Digital ISI	9588	SB-M55	Dissecting forceps S.S.6"	425
SB-M18	B.P instruments Mercurial ISI	5950	SB-M56	Dissecting forceps S.S.8"	425
SB-M19	B.P. Blade	425	SB-M57	Dissecting forceps S.S.7"	425
SB-M20	B.P.Instruments stand modal ISI	7684			
SB-M21	Ball Mill 1 kg	27265			
SB-M22	Ball Mill 2 kg	38372			
SB-M23	Bandage cutting scissor 10"	425			

Cat No.	Description	Price ₹
SB-M58	Digital Melting Point Apparatus	131274
SB-M59	Digital thermometer	425
SB-M60	Dissolution Test apparatus	60588
SB-M61	Dissolution RPM single (Digital)	60588
SB-M62	Dissolution RPM with Temp. Single	80784
SB-M63	Dissolution Apparatus Single Phase	40392
SB-M64	Dissolution Apparatus Single Phase Six Stages	403920
SB-M65	Disintegrator apparatus	65637
SB-M66	Double cone Blender with motor	65637
SB-M67	Double cone Blender with gear box	90882
SB-M68	Double unit orange bath	28274
SB-M69	Dressing Drum S.S. 10x12	4250
SB-M70	Dressing Drum S.S. 12x15	4760
SB-M71	Dressing Drum S.S. 8x10	1445
SB-M72	Dressing scissor S.S.9"	425
SB-M73	Dressing Scissor S.S 8"	425
SB-M74	Dressing Scissor S.S 10"	425
SB-M75	Eddy Hot Plate	40392
SB-M76	Emergency Fluorescent Lighting Double Tube, 230 V	13500
SB-M77	Fetal Monitor pulse meter	3594
SB-M78	Foot step ss	4250
SB-M79	Friability Digital RPM Single Drum	45441
SB-M80	Friability Digital RPM Timer Single	60588
SB-M81	Friability Double drum	270994
SB-M82	Friability single drum	40392
SB-M83	Frog Board big size	1111
SB-M84	Frog Board Small size	707
SB-M85	Glucometer	4250
SB-M86	Hand Grinding Mill	6059
SB-M87	Hand torch 3 cell	225
SB-M88	Heart Lever	1212
SB-M89	Histamine chamber	22216

Cat No.	Description	Price ₹
SB-M90	Hospital Wheel chair folding	14450
SB-M91	Hot Water Bag	1105
SB-M92	Infusion pump	14450
SB-M93	Instrument Sterilizer ss 16x6x4	11050
SB-M94	Instrument Sterilizer ss 18x6x4	11050
SB-M95	IUCD Set Stainless Steel	14450
SB-M96	IV Stands for Hospital, Heavy Duty	4250
SB-M97	Jumping box	90882
SB-M98	Kidney Tray S.s 10"	425
SB-M99	Kidney Tray S.s 8"	425
SB-M100	Kocher forceps S.S ISI mark 5"	425
SB-M101	Kocher forceps S.S ISI mark 6"	425
SB-M102	Kocher forceps S.S. ISI mar 7"	425
SB-M103	Kocher forceps S.S. ISI mark 8"	425
SB-M104	L.P. Needle	425
SB-M105	Laboratory	22216
SB-M106	Magnetic storm	10098
SB-M107	Mosquito artery forceps S.S Isi 7"	425
SB-M108	Mosquito artery forceps S.S Isi 5"	425
SB-M109	Mosquito artery forceps S.S Isi 6"	425
SB-M110	Mosquito artery forceps S.S. Isi 8"	425
SB-M111	Mayo Scissors S.S 5"	425
SB-M112	Mayo Scissors S.S 6"	425
SB-M114	Mayo Scissors S.S 7"	425
SB-M115	Mayo Scissors S.S 8"	425
SB-M116	Medicine trolley 69x45x83	14450
SB-M117	Microscope Binocular	8594
SB-M118	Mixing Vat with stirrer	3029
SB-M119	Monsanto Type Tablet Hardness Tester	7069
SB-M120	Needle Destroyer machine	7650
SB-M121	Needle holder s.s 8"	425
SB-M122	Needle holder S.S. 6"	425
SB-M123	Needle holder S.S. 7"	425
SB-M124	Ointment slab	757
SB-M125	Operation Table small	12118

Cat No.	Description	Price ₹
SB-M126	Operation table small animal	40392
SB-M127	Outlet forcep S.S 10"	425
SB-M128	Oxygen Cylinder key	1105
SB-M129	Oxygen Cylinder complete set 20 C.F.T	16150
SB-M130	Oxygen flow meter	3060
SB-M131	Pediatric Suction Machine electric	14450
SB-M132	Passive Avoidance Response Test App.	100980
SB-M133	Pfizer type Tablet Hardness Tester	17167
SB-M134	Pole Climbing apparatus	60588
SB-M135	Polishing Pan	15147
SB-M136	Postmortum Gloves(pair)	425
SB-M137	Postmortum set with all instru.S.s.	9520
SB-M138	Punching Machine	11108
SB-M139	Rota Road ii camp	50490
SB-M140	Rota Road iii camp	55539
SB-M141	Rota Road iv camp	60588
SB-M142	Rota Road v camp	70686
SB-M143	Shock Box	40392
SB-M144	Simple Lever	757
SB-M145	Single unit orange bath	12118
SB-M146	Smoking Burner	6564
SB-M147	Smoking Burner - Kerosene	5049
SB-M148	Sponge holding forcep S.S ISI 10"	425
SB-M149	Sponge holding forcep S.S ISI 8"	425
SB-M150	Stethoscope	425
SB-M151	Stethoscope ISI	1445
SB-M152	Stitch cutting scissor S.S 8"	425
SB-M153	Stitch cutting scissor S.S 6"	425
SB-M154	Stomach wash tube	1445
SB-M155	Strecher folding made of canvas	4250
SB-M156	Strecher with trolley	6460
SB-M157	Suction Apparatus electric	14450
SB-M158	Suction Apparatus S.S. top trolley model	14450
SB-M159	Suction cannula	425

Cat No.	Description	Price ₹
SB-M160	Surgical tray with cover S.S. 10x10	895
SB-M161	Surgical tray with cover S.S. 8x10	425
SB-M162	Surgical tray with cover S.S.10x12	425
SB-M163	Surgical tray with cover S.S.12x15	1445
SB-M164	Swimming Test Apparatus	65637
SB-M165	T.L.C. KIT	40392
SB-M166	Tablet Counter	4544
SB-M167	Tail Flick Apparatus	20196
SB-M168	Teeth forcep S.S 5"	425
SB-M169	Teeth forcep S.S 6"	425
SB-M170	Teeth forcep S.s 7"	425
SB-M171	Teeth forcep S.S 8"	425
SB-M172	Tele thermometer single prove	17167
SB-M173	Tele thermometer six prove	25245
SB-M174	Thumb forcep S.S. Isi 10"	425
SB-M175	Thumb forcep S.S. Isi 8"	425
SB-M176	Tincher press	15147
SB-M177	Tissu Homozeniser	23225
SB-M178	Tube Filling	40392
SB-M179	U.v. Cabinet small	28274
SB-M180	Urin port S.s. female	1105
SB-M181	Urin port S.s. male	1105
SB-M182	Vaginal Retractor 12"S.s	425
SB-M183	Vaginal soeaculam S.s	425
SB-M184	Vulsellum forceps S.S. Isi 8"	425
SB-M185	Vuisellum forceps S.S. Isi 10"	425
SB-M186	Weight Machine child Isi	4250
SB-M187	Weight machine Adult Digital	4250
SB-M188	Weight Machine Adult ISI	4250

Test Sieves Price List TEST SIEVE 8'BRASS

BSS	ASTM	ISS	MICRO NS	MO	PRICE
4	5	480	4750	4.75	1536
5	6	340	3353	3.25	1536
6	7	280	2813	2.80	1536
7	8	240	2411	2.36	1536
8	10	200	2057	2.00	1536
10	12	170	1698	1.70	1536
12	14	140	1405	1.40	1536
14	16	120	1204	1.18	1536
16	18	100	1000	1.00	1536
18	20	85	850	0.250	1536
22	25	70	710	0.410	1536
25	30	60	600	0.500	1536
30	35	50	500	0.500	1536
36	40	40	425	0.425	1536
44	45	35	355	0.355	1536

BSS	ASTM	ISS	MICRO NS	MO	PRICE
52	50	0	300	0.000	1536
60	60	25	250	0.250	1536
72	70	20	212	0.212	1536
85	80	18	180	0.180	1536
100	100	15	150	0.150	1536
120	120	12	125	0.125	1664
150	140	10	106	0.106	1741
170	170	9	90	0.000	1792
200	200	8	75	0.075	1843
240	230	7	63	0.063	2048
300	270	6	53	0.053	2048
325	300	5	45	0.045	2432
350	325	4	44	0.044	2304
400	380	3	38	0.035	2560

Rhizon samplers, for extracting pore water



Rhizons for sampling pore water

Rhizon samplers extract small volumes of pore water from soil and sediments, in an easy, non-destructive way. They can be used for sampling water from unsaturated soils as well as from saturated zones.

For the measurement of all dissolved compounds in soil moisture or water, Rhizon samplers can be used. The mean pore size of the porous part is 0.15 µm, hence filtering the samples before analyzing is unnecessary.

New: Also Rhizons with a mean pore size of 0.6 µm are available. Have a look on [Rhizons](#) or [contact us](#).

Rhizon samplers are made of inert polymer with no ion exchange properties. Other advantages of Rhizons are their small diameter and low dead volume. Rhizons are easy to handle and once installed for an experiment, they can be used frequently.



Rhizon Sampler Price List

Cat No.	Description	Pk size	Price Rs.
19.21.01	Rhizon SMS, 10 cm porous, 12 cm tubing, male luer	10	38254
19.21.01F	Rhizon SMS, 10 cm porous, 12 cm tubing, female luer	10	38254
19.21.02	Needles, sterilized, 0.8*40 mm	10	19958
19.21.03	Vacuum tubes, no additives, plastic, 9 ml	50	26796
19.21.04	Syringeset 10 ml, female connector and retainer 7 cm	10	24394
19.21.05	Rhizon SMS, 5 cm porous, 12 cm tubing, male luer	10	37145
19.21.05F	Rhizon SMS, 5 cm porous, 12 cm tubing, female luer	10	37145
19.21.08F	FF-connector for male sampler and syringe	10	19958
19.21.08M	MM-connector for female sampler and needle and vacuum tube	10	19958
19.21.09.7	Wooden retainer 7 cm for syringe 10 ml	10	19958
19.21.09.8	Wooden retainer 8,5 cm for syringe 20 ml	10	19958
19.21.09.10	Wooden retainer 10 cm for syringe 30 ml	10	19958
19.21.10	Female connector and retainer 7 cm	10	21252
19.21.13	Silicone tubing, 6*2 mm, length 1 m	10	19958
19.21.14	PE tube, black, 3.2*1 mm, length 50 m	1	25133
19.21.16	PE/PVC tube, transparent, 2.5*1 mm, length 50 m	1	30122
19.21.18	2-way stopcock	10	22915
19.21.19	3-way stopcock	10	23470
19.21.21	Rhizon MOM, 10 cm porous, 12 cm tubing, male luer	10	38254
19.21.21F	Rhizon MOM, 10 cm porous, 12 cm tubing, female luer	10	38254
19.21.22	Rhizon MOM, 5 cm porous, 12 cm tubing, male luer	10	37145
19.21.22F	Rhizon MOM, 5 cm porous, 12 cm tubing, female luer	10	37145
19.21.23	Rhizon CSS, 5 cm porous, 12 cm tubing, male luer	10	39917
19.21.23F	Rhizon CSS, 5 cm porous, 12 cm tubing, female luer	10	39917
19.21.24	Rhizon CSS, 10 cm porous, 12 cm tubing, male luer	10	41026
19.21.24F	Rhizon CSS, 10 cm porous, 12 cm tubing, female luer	10	41026
19.21.25	Rhizon Flex, 10 cm porous, 60 cm tubing, male luer	10	38254
19.21.25F	Rhizon Flex, 10 cm porous, 60 cm tubing, female luer	10	38254
19.21.26	Rhizon Flex, 5 cm porous, 30 cm tubing, male luer	10	37145
19.21.26F	Rhizon Flex, 5 cm porous, 30 cm tubing, female luer	10	37145
19.21.35	MacroRhizon, 9 cm porous, female luer	10	53962
19.21.36	MacroRhizon mount on PVC-pipe 90 cm, female luer	10	89074
19.21.37	MacroRhizon spare tip	10	51190
19.21.38	MacroRhizon mount on PVC-pipe 30 cm, female luer	10	82236
19.21.39	MacroRhizon mount on PVC-pipe 60 cm, female luer	10	85008
19.21.44	Extension PVC/PE tubing 100 cm, incl. male and female luer	10	28644
19.21.45	Extension PVC/PE tubing 50 cm, incl. male and female luer	10	27350
19.21.46	Syringe set 20 ml and retainer 8.5 cm	10	24578
19.21.47	Syringe set 50 ml and retainer 12 cm	10	28644
19.21.48	Syringe set 10 ml and retainer 7 cm	10	22915
19.21.49	Syringe set 30 ml and retainer 10 cm	10	27350
19.21.51	Insertion tool MacroRhizon, length 100 cm	1	36590
19.21.54	Silicon sleeve mount on Rhizon sampler	10	21806
19.21.61	RhioCera, 5 cm female luer	10	67082
19.21.62	RhioCera, plain	10	57288
19.21.71	Rhizon irrigator	10	64310
19.21.81	MicroRhizon, 8 mm porous, 12 cm PEEK tubing, connection for syringe	10	61538
19.21.82	MicroRhizon, 8 mm porous, 12 cm PEEK tubing, PEEK guide, connection for syringe	10	68376
19.21.83	MicroRhizon, 8 mm porous, 12 cm PEEK tubing, silicon sleeve, connection for syringe	10	64310
19.21.84	PEEK guide tubing 5 cm	10	25502

Cat No.	Description	Pk size	Price Rs.
19.21.85	PEEK extension tubing 30 cm	10	33818
19.21.88	Syringe set 5 ml and retainer 5 cm for MicroRhizon	10	22361
19.31.80	Rhizon Box for MicroRhizon (19.21.81)	1	170940
19.60.01F	Rhizon SMS, 10 cm porous 0.6 µm, 12 cm tubing, female luer	10	38993
19.60.05F	Rhizon SMS, 5 cm porous 0.6 µm, 12 cm tubing, female luer	10	37884
19.60.21F	Rhizon MOM, 10 cm porous 0.6 µm, 12 cm tubing, female luer	10	38993
19.60.22F	Rhizon MOM, 5 cm porous 0.6 µm, 12 cm tubing, female luer	10	37884
19.60.23F	Rhizon CSS, 5 cm porous 0.6 µm, 12 cm tubing, female luer	10	40656
19.60.24F	Rhizon CSS, 10 cm porous 0.6 µm, 12 cm tubing, female luer	10	41765
19.60.25F	Rhizon Flex, 10 cm porous 0.6 µm, 60 cm tubing, female luer	10	38993
19.60.26F	Rhizon Flex, 5 cm porous 0.6 µm, 30 cm tubing, female luer	10	37884

RESERVOIRS FOR ROBOTIC SYSTEMS

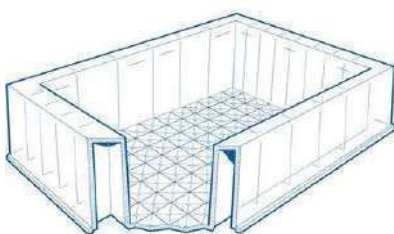

240 ml Reservoir, Single-Well | 96 Pyramid Bottoms | High Profile | All robotic reservoirs are certified RNase, DNase and Pyrogen free | 25plates/PACK

High quality for high throughput!

STARLAB reservoirs conform to the standard SBS footprint for compatibility with most robotic systems. They have virtually no dead volume and are available in high- or low profile and two well styles. The sturdy polypropylene construction ensures rigidity during automation

and provides excellent chemical resistance.

RESERVOIRS FOR ROBOTIC SYSTEMS



Cat. No.	E2999-8008	E2999-8412	E2999-2496
Description	80 ml Reservoir, Multi-Well 8-Channel High Profile	84 ml Reservoir, Multi-Well 12-Channel High Profile	240 ml Reservoir, Single-Well 96 Pyramid Bottoms High Profile
Packaging	1 Box × 25 Reservoirs		
HSN	9031		
Price ₹	₹ 54165.00	₹ 54165.00	₹ 54165.00

PIPETTE CAROUSEL (EPPENDORF PIPETTE HOLDER STAND)

Pipette Carousel 2 carries up to six manual single or multi-channel pipettes. Single pipette holders can be mounted to the carousel in two orientations turned by 180 degrees to each other to store all current and most predecessor manual pipettes. This includes Eppendorf Research, Research plus, Reference, Reference 2 and Biomaster.



EPPENDORF PIPETTE HOLDER SYSTEM

Cat. No.	Description	HSN	GST%	Price
3116.000.015	Pipete stand for 6 micropipette		18%	16550

EPPENDORF PIPETTE SPECIAL PACKAGE

Cat. No.	Description	HSN	GST%	Price
3120.000.934	Eppendorf Research® plus 6-pack (0.1-2.5 µL, 0.5-10 µL, 2-20 µL yellow, 10-100 µL, 20-200 µL, 100-1000 µL, 0.5-5 mL), epT.I.P.S.® Box (0.1-20 µL, 2-200 µL), epT.I.P.S.® Standard 100-5000 µL (5 bags of 100 tips) and a Pipette carousel	9420	18%	147580

Biological Stabilization Products

Innovative solutions to stabilize, store & ship biological samples (DNA, RNA, Blood, E.Coli) at Room Temperatures.

Biological stabilization products to improve the reliability of diagnostic testing performed anywhere, under any conditions

DNASTABLE®

Stabilize store and ship purified DNA at room temperature

- Long-term stabilization, storage and shipment of DNA at room temperature
- High yield DNA recovery and use without further purification
- Compatible with most downstream applications, e.g., PCR, sequencing, and microarrays
- Available in a variety of compact formats, e.g., tubes, multi-well plates & custom.
- Cost-effective, eco-friendly solution to freezer crawl and lab space management

DNASTABLE® enables you to preserve, store and ship your purified DNA samples at room temperature. Sample recovery is achieved within minutes by simply adding water or buffer to the matrix. Sample is ready for downstream analysis without need for any additional purification step.

Catalog No.	Product Description	Size	Price
93021-001	DNASTABLE® Tube Kit	25 tubes of DNASTABLE	43680
93021-011	DNASTABLE® (3 x 25) Tube Kit	3 x 25 tubes of DNASTABLE	53120
90021-001	DNASTABLE® 96-Well Plate	1 DNASTABLE 96-well plate	29360
90022-001	DNASTABLE® 96-Well 10 Plate Kit	10 DNASTABLE 96-well plates	98600
48901-399	DNASTABLE® Validation Kit for Forensic Labs	1 kit	460000
53001-066	DNASTABLE® LD	2 ml 100 rxns	58760

52001-026	DNASTable® LD	10 ml 500rxns	274120
52091-036	DNASTable® LD	50 ml 2500rxns	675280
93000-001	DNASTable® Trial Kit	3 tubes of DNASTable	28320

DNASTable® Plus

Stabilize and store purified DNA at Room Temperature

- Next generation liquid preservative for purified DNA - at all temperatures
- Liquid format option compatible with automation and sample handling workflows
- Recover high amounts of DNA and analyze instantly without further purification
- Compatible with most downstream applications, e.g., PCR, RT-PCR, SNP analysis, DNA sequencing, etc.
- Cost-effective, eco-friendly solution to freezer crawl and lab space management

Catalog No.	Product Description	Size	Price
53091-016	DNASTable® Plus	2 mL	50240
52091-026	DNASTable® Plus	10 mL	207520
59000-011	DNASTable® Plus Trial Kit	0.75 mL	29360

DNASTable® Blood

Stabilize and Preserve DNA in Whole Blood at Room Temperature

- Preserve DNA in blood and buffy coat samples for at least 12 years at ambient temperatures.
- Cost effective and convenient blood sample archiving
- Available in either liquid or pre-dried formats
- Compatible with all downstream applications
- Cost Effective Solutions to Store Blood Samples

DNASTable® Blood and DNASTable® Blood LD are innovative products for dry storage and preservation of DNA in blood samples at ambient temperatures. The DNASTable Blood matrix forms a thermostable barrier as samples dry, protecting the blood DNA from degradation. DNASTable Blood is available in two convenient formats: pre-dried in tubes and multi-well plates (DNASTable Blood) and liquid (DNASTable Blood LD). Once the DNASTable Blood reagent is mixed with blood, samples can be dried in a laminar flow hood at room temperature, in a ventilated 40°C incubator, or in a vacuum centrifuge. Samples can then be stored at ambient temperature for at least 12 years (based on accelerated aging studies).

Catalog No.	Product Description	Size	Price
93020-017	DNASTable® Blood Trial Kit	3 Tubes	24320
93027-027	DNASTable® Blood Tubes	50 tubes of DNASTable Blood	52400
57022-357	DNASTable® Blood 48-Well Plate Pack	10 x DNASTable Blood 48-well plates	207280
90622-026	DNASTable® Blood 96-Well Plate Pack	10 x DNASTable Blood 96-well plates	84800
52001-047	DNASTable® Blood LD	100 mL	228880

RNASTable®

Stabilize and store RNA at Ambient Temperatures

- Preserves RNA at ambient temperatures without degradation
- Eliminates the need to store RNA in freezers or to ship on dry ice
- Concentrates RNA more effectively than other methods
- Compatible with most downstream applications

RNASTable® and RNASTable® LD allows you to preserve and ship your total RNA, mRNA, and miRNA for up to 12 years at ambient temperatures*. They provide a cost-effective, eco-friendly solution to freezer crawl and lab space

management. Moreover, they eliminate sample loss due to freeze/thaw cycles. When you are ready to use your RNA samples, you can fully recover them in minutes without any additional purification steps.

RNAstable is available in two convenient formats:

RNAstable: provided pre-dried in 1.5 ml microfuge tubes and 96-well plates to which hydrated RNA can be added.
RNAstable LD: a liquid reagent which can be added directly to RNA samples in your own tubes, multi-well plates, or other containers.

Catalog No.	Product Description	Size	Price
93220-001	RNAstable® Trial Kit	(3) Tubes of RNAstable®	25520
93221-001	RNAstable® Tube Kit	(25) Tubes of RNAstable®	39200
93221-011	RNAstable® Tube Kit	3 x (25) Tubes of RNAstable®	73400
90220-001	RNAstable® 96-Well Plate	(1) 96-well plates	37880
16901-081	Breathe-EASIER Membranes	100-pack	26960
53201-013	RNAstable® LD 2ml	(1) 2ml bottle of liquid RNAstable® for dry storage 100rxns	74120
52201-013	RNAstable® LD 10ml	(1) 10ml bottle of liquid RNAstable® for dry storage 500rxns	214480

RESEARCH/EXPERIMENTAL FIELD/FARM USABLES

THREE LAYERED ALUMINIUM FOIL POUCH PLAIN

Cat. No.	Description	HSN	GST%	Price
712-010A	20x16cm 100pc/pk		18%	1200
712-010B	30x23cm 100pc/pk		18%	1700
712-010C	18x12cm 100pc/pk		18%	1000
712-010D	12x8cm 100pc/pk		18%	800
712-010E	30x12cm 100pc/pk		18%	1100



THREE LAYERED ALUMINIUM FOIL POUCH Printed

Cat. No.	Description	HSN	GST%	Price
712-011A	20x16cm 100pc/pk		18%	1200
712-011B	30x23cm 100pc/pk		18%	1700
712-011C	18x12cm 100pc/pk		18%	1000
712-011D	12x8cm 100pc/pk		18%	1200
712-011E	30x12cm 100pc/pk		18%	2000

LINT FREE WIPES

Cat No.	Description	HSN	GST%	Price
812-105	11.3 × 20 cm (4.5" × 8.5)	28230010	18%	18577





LABORATORY APRON

Cat No.	Description	HSN	GST%	Price
812-106	Terricot/ cotton 5pcs/Pk	28230010	18%	4000

PLASTIC BAG WITH LAMINATION

Cat No.	Description / Capacity	HSN	GST%	Price/pk
812-107	05 Kg 100Pc/pk			1800
812-108	10 Kg 100Pc/pk			2000
812-109	20 Kg 100Pc/pk			2500
812-110	40 Kg 100Pc/pk			4000



INSECT PROOF NYLON NETTING. UV STABILIZED

Cat No.	Description	HSN	GST%	Price/sq mtr
812-111	20 Mesh			80
812-112	40 Mesh			85
812-113	60 Mesh			90

NYLON NET for BIRD protection

Cat No.	Description	HSN	GST%	Price/sq mtr
812-114	12.5 mm MESH SIZE			65
812-115	25 mm MESH SIZE			50



UV STABILIZED POLYTHENE SHEET 200 MICRON

Cat No.	Description	HSN	GST%	Price/sq mtr
812-116	Width 7 Mtr			108
812-117	Width 9 Mtr			105

INSECT TRAP POLYTHENE BAG YELLOW COLOUR

Cat No.	Description	HSN	GST%	PRICE/PK
812-118	23 cm x 15 cm 100pCS PACK			350
812-119	30 cm x 17 cm 100pCS PACK			450





PLASTIC WHITE FLY YELLOW TRAP

Cat No.	Description	HSN	GST%	PRICE
812-120	45 cm x 25 cm			550
812-121	30 cm x 22 cm			430

INSECT COLLECTION NET

Cat No.	Description	HSN	GST%	Price/pc
812-122	insect collection net			880



NYLON NET BAG



Set Garden Plant against Insect Fruit Protect Drawstring Mesh Net Bag, Fruit Protect Bag with Drawstring, Reusable Nylon Mesh Garden Netting Protection Bag for Plant/Fruit/Flower

NYLON NETTING BAG

Cat No.	Description	HSN	GST%	Price/pk
812-123	14" x 7" 500pcs/pk			2950
812-124	18" x 12" 500pcs/pk			4350

PLASTIC SHEET MULCHING

Cat No.	Description	HSN	GST%	Price/pc
812-125	1.2 mtr width (25 Micron) 400mtrs roll			4500
812-126	1.2 mtr width (50 Micron) 400mtrs roll			8500
812-127	1.2 mtr width (100 Micron)400mtrs roll			15500



U.V. STABILIZED RIGIDEX FILM

Cat No.	Description	HSN	GST%	Price/sq mtr
812-128	120 GSM			130
812-129	150 GSM			180

Ointment Spatulas					
Cat No.	Description	HSN	GST%	Price/sq mtr	
812-130	4 inch Wooden handle 10pcs/pk			200	
812-131	6 inch Wooden handle 10pcs/pk			210	
812-132	6 Stainless Steel handle 10pcs/pk			385	
812-133	Pointer Spatula 6 inch 10pcs/pk			130	



Plastic Arrow Type Tree Label					
Cat No.	Description	HSN	GST%	Price/pk	
812-134	Plastic, White colour, Rectangle Arrow Shape, 8cm X 1.5cm 1000pcs			550	

Seed Packet Tag / Harvesting Tag					
Cat No.	Description	HSN	GST%	Price/pk	
812-135	Seed Packet Tag Paper Tag with cloth lining for better grip, Yellow, 12x6 cm, 100 pcs/pk			1800	



Pond Lining					
Cat No.	Description	HSN	GST%	Price/sq mtrs	
812-136	200 micron			30	

Field Usables - SciNation					
Cat No.	Description	HSN	Pk.	GST%	Price/pk
SN412-001	Autoclavable Bag for mushroom size 40x17 cm	39269099	1000	18%	2731
SN412-002	Plastic Ring for Mushroom 30 mm x 16 mm	39269099	Each		3
SN412-003	Plastic Ring for Mushroom 35 mm x 20 mm	39269099	Each		3
SN412-004	Tassel bag 80 GSM Star paper machine made 420 x 180 x 100 mm	39269099	1000		3312
SN412-005	Sorghum Pollinating bag machine made 60 GSM Star Paper 420 x 120 x 60 mm	39269099	1000		1990
SN412-006	Kraft paper bag machine made 80 GSM Star Paper 150 x 100 mm	4804	1000		748
SN412-007	Kraft paper bag machine made 80 GSM Star Paper 350 x 80 mm	4804	1000		1104

Field Usables - SciNation					
Cat No.	Description	HSN	Pk.	GST%	Price/pk
SN412-008	Imported Parchment Paper Bag machine made 230 x 90 mm	39269099	1000		1242
SN412-009	Imported Parchment Paper Bag machine made 200 x 80 mm	39269099	1000		1104
SN412-010	Butter paper bag machine made 420 x 120 x 60 mm	48239090	1000		2622
SN412-011	Butter paper bag machine made 350 x 90 mm	48239090	1000		1242
SN412-012	Butter paper bag machine made 230 x 90 mm	48239090	1000		897
SN412-013	Butter paper bag machine made 200 x 80 mm	48239090	1000		748
SN412-014	Butter paper bag machine made 100 x 60 mm	48239090	1000		483
SN412-015	Muslin Cloth Bag 380 x 220 mm	63049229	Each		9
SN412-016	Muslin Cloth Bag 220 x 150 mm	63049229	Each		5
SN412-017	Muslin Cloth Bag 1000 x 900 mm	63049229	Each		69
SN412-018	Muslin Cloth Bag 400 x 400 mm	63049229	Each		15
SN412-019	Nylon net Selfing bag with closing string for veg. crop 300 x 200 mm	39269099	Each		7
SN412-020	Nylon net Selfing bag with closing string for veg. crop 450 x 300 mm	39269099	Each		14
SN412-021	Nylon net Selfing bag with closing string for veg. crop 700 x 450 mm	39269099	Each		23
SN412-022	Nylon net Selfing bag with closing string for veg. crop 950 x 700 mm	39269099	Each		37
SN412-023	Nylon net Selfing bag with closing string for veg. crop 1000 x 900 mm	39269099	Each		52
SN412-024	Kraft Seed Container Star Paper 80 GSM 120 x 70 mm	4804	1000		449
SN412-025	Kraft Seed Container Star Paper 80 GSM 150 x 70 mm	4804	1000		483
SN412-026	Kraft Seed Container Star Paper 80 GSM 190 x 70 mm	4804	1000		598
SN412-027	Kraft Seed Container Star Paper 80 GSM 250 x 100 mm	4804	1000		943
SN412-028	Kraft Seed Container Star Paper 80 GSM 350x125 mm	4804	1000		1357
SN412-029	Water Proof Envelopes Star Paper 280 x 120 mm	4804	1000		4428
SN412-030	Water Proof Envelopes Star Paper 250 x 100 mm	4804	1000		3450
SN412-031	Water Proof Envelopes Star Paper 200 x 100 mm	4804	1000		2898
SN412-032	Golden Yellow Seed Packet Thick quality 150x80 mm	39269099	1000		1104
SN412-033	Golden Yellow Seed Packet Thick quality 100x60mm	39269099	1000		828
SN412-034	Yellow Metal Fold Seed Packet 130 x 80 mm	39269099	1000		1656
SN412-035	Yellow Metal Fold Seed Packet 180 x 100 mm	39269099	1000		2070
SN412-036	Markin Cloth bag 500 gm capacity/size 220x150 mm	61159500	Each		6
SN412-037	Markin Cloth bag 1000 gm capacity/size 300x170mm	61159500	Each		7
SN412-038	Markin Cloth bag 2000 gm capacity/size 370x220mm	61159500	Each		12
SN412-039	Markin Cloth bag 3000 gm capacity/size 400x250mm	61159500	Each		15
SN412-040	Markin Cloth bag 5000 gm capacity/size 450x300mm	61159500	Each		18

Field Usables - SciNation					
Cat No.	Description	HSN	Pk.	GST%	Price/pk
SN412-041	Markin Cloth bag 10000 gm capacity or size 520 x 350 mm	61159500	Each		23
SN412-042	Markin Cloth bag 15000 gm capacity or size 600 x 450 mm	61159500	Each		35
SN412-043	Markin Cloth bag 20000 gm capacity or size 750 x 450 mm	61159500	Each		41
SN412-044	Markin Cloth bag 30000 gm capacity or size 800 x 600 mm	61159500	Each		55
SN412-045	Markin Cloth bag 500 gm Superior Quality size 220 x 150 mm	61159500	Each		8
SN412-046	Markin Cloth bag 1000 gm Superior Quality size 300 x 170 mm	61159500	Each		10
SN412-047	Markin Cloth bag 2000 gm Superior Quality size 370 x 220 mm	61159500	Each		16
SN412-048	Markin Cloth bag 3000 gm Superior Quality size 400 x 250 mm	61159500	Each		20
SN412-049	Markin Cloth bag 5000 gm Superior Quality size 450 x 300 mm	61159500	Each		25
SN412-050	Markin Cloth bag 10000 gm Superior Quality size 520 x 350 mm	61159500	Each		31
SN412-051	Markin Cloth bag 15000 gm Superior Quality size 600 x 450 mm	61159500	Each		45
SN412-052	Markin Cloth bag 20000 gm Superior Quality size 750 x 450 mm	61159500	Each		54
SN412-053	Markin Cloth bag 30000 gm Superior Quality size 800 x 600 mm	61159500	Each		75
SN412-054	Muslin Cloth Bag 220 x 150 mm	63079020	Each		5
SN412-055	Muslin Cloth Bag 380 x 220 mm	63079020	Each		9
SN412-056	Muslin Cloth Bag 400 x 400 mm	63079020	Each		15
SN412-057	Muslin Cloth Bag 450 x 300 mm	63079020	Each		14
SN412-058	Muslin Cloth Bag 600 x 450 mm	63079020	Each		24
SN412-059	Muslin Cloth Bag 1000 x 900 mm	63079020	Each		69
SN412-060	Luggage Lable No. 3 Eyeletted 80 x 40 mm	39269099	1000		368
SN412-061	Luggage Lable No. 4 Eyeletted 100 x 50 mm	39269099	1000		391
SN412-062	Luggage Lable No. 5 Eyeletted 110 x 60 mm	39269099	1000		414
SN412-063	Luggage Lable No. 4 with Plastic Cover	39269099	1000		1656
SN412-064	Plant tag with thread Oval Shape (Tag Lable / Price Lable)	39269099	1000		173
SN412-065	Aluminium Lable 80 x 30 mm with wire	76169990	1000		598
SN412-066	Aluminium Lable with tail	76169990	1000		2300
SN412-067	Bird Scaring Ribbon Red & silver color	39269099	kg		759
SN412-068	Threshing Sheet Dasuti Cloth 3 x 3 meter	63079020	Each		966
SN412-069	Threshing Sheet Dasuti Cloth 4 x 4 meter	63079020	Each		1553
SN412-070	Tarpaulin Assorted Size	630612	Sq.mtr		230
SN412-071	Counting Board made of Plastic Sheet 50/100 holes for wheat/pulses/ maize/sorghum etc.	39269099	Each		2875



- MOLECULAR BIOLOGY/ ELISA KITS/ RIA KITS/ ANTIBODIES/
 - PLANT ANTIBODIES / DETECTION REAGENTS
 - LABORATORY REAGENTS, FINE CHEMICALS & FILTER PAPERS
- CUSTOM DNA SYNTHESIS (DESALTED DNA OLIGOS)
- SEQUENCING SERVICES/ NEXT GENERATION SEQUENCING
 - CUSTOM OLIGO SYNTHESIS
- ASSAY KITS FOR FOOD, FEED, DAIRY, WINE, BEVERAGE, CEREALS, FERMENTATION AND BIOFUEL
- LIQUID HANDLING, CYTOGENETICS, ROBOTICS
- CLINICAL CHEMISTRY : BIOCHEMISTRY / DIAGNOSTICS REAGENTS / KITS/ PATHOLOGY LAB REAGENTS/ CHEMICALS

2022

PRISTINE BIOMEDICAL

CB 201, Suite #6, Guru Harkishan Plaza
Industrial Area, Naraina Ring Road
New Delhi 110028

Ph: +91 965 427 3263, +91 888 278 0325
info@pristinebiomedical.com, pristbio@gmail.com
<https://www.pristinebiomedical.com>

Part	NO	Product Name	Cat.No	Size	Type	Application	Price	Expy	Stor
Genomic DNA	1	G-spin™ Total DNA Extraction Mini Kit	17045	50 Col	Spin	Genomic DNA: Cell / tissue	₹23,520	2 years	RT
	2		17046	200 Col			₹76,800	2 years	RT
	3	G-spin™ Genomic DNA Extraction Mini Kit (Bacteria)	17121	50 Col	Spin	Genomic DNA: Bacteria	₹27,120	2 years	RT
	4	G-DEX™ IIc Genomic DNA Extraction Kit (Cell/Tissue)	17231	300 Tests	Solution	Genomic DNA: Cell / tissue	₹42,000	2 years	RT
	5	i-genomic BYF DNA Extraction Mini Kit	17361	50 Col	Spin	gDNA: Bacteria/Yeast/Fungi	₹34,800	2 years	RT
	6	i-genomic Plant DNA Extraction Mini Kit (Plant)	17371	50 Col	Spin	Genomic DNA: plant	₹36,720	2 years	RT/B
	7	i-genomic Clinic DNA Extraction Mini Kit	17384	50Col	Spin	Genomic DNA: Clinic	₹52,320	2 years	RT
Plasmid DNA	1	DNA-spin™ Plasmid DNA Purification Kit	17096	50 Col	Spin	Plasmid DNA	₹9,600	2 years	RT
			17098	200 Col	Spin	Plasmid DNA	₹28,800	2 years	RT
	2	Fast DNA-spin™ Plasmid DNA Purification Kit	17013	200 Col	Spin	Plasmid DNA	₹31,440	2 years	RT
	3	DNA-midi™ GT Plasmid DNA Extraction Kit (Gravity)	17254	25 Tests	Gravity	Plasmid DNA	₹49,680	2 years	RT
	4	DNA-maxi™ SV Plasmid DNA Purification Kit	17253	12 Col	Spin/Vacuum	Plasmid DNA	₹38,400	2 years	RT
5	MEGAquick-spin™ plus Total Fragment DNA Purification Kit	17290	200 Col	Spin	DNA Fragment	₹38,400	2 years	RT	
RNA	1	easy-BLUE™ Total RNA Extraction Kit	17061	100 ml	Solution	Total RNA: Cell/tissue	₹32,400	2 years	B
	2	easy-spin™ Total RNA Extraction Kit	17221	50 Col	Spin	Total RNA: Cell/Tissue	₹46,320	2 years	RT
	3	IQeasy™ Plus Plant RNA Extraction Mini Kit	17491	50 Col	Spin	Total RNA: Plant	₹52,320	2 years	RT
	4	RNA-spin™ Total RNA Extraction Kit	17211	50 Col	Spin	Total RNA: Cell/Tissue	₹40,080	2 years	RT
	5	Viral Gene-spin™ Viral DNA/RNA Extraction Kit	17151	50 Col	Spin	Viral DNA/RNA	₹34,800	2 years	RT

Part	NO	Product Name	Cat.No	Size	Type	Application	Price	Expy	Stor
	6	Patho Gene-spin™ Viral DNA/RNA Extraction Kit	17154	50 Col	Spin	Pathogenic samples	₹38,400	2 years	RT
	7		17154.2	200 col	Spin	Pathogenic samples	₹130,560	2 years	RT
	8	RNase WiPER	21131	200ml * 2ea	Spin	RNase Remover	₹15,600	2 years	RT
Protein	1	PRO-PREP™ Protein Extraction Solution (Cell/Tissue)	17081	100 ml	Solution	Protein Prep.	₹22,800	2 years	D
	2	PRO-PREP™ Protein Extraction Solution (Cell/Tissue) (EDTA free)	17081.1	100 ml	Solution	Protein Prep.	₹22,800	2 years	B/D
	3	PRO-MEASURE™ Protein Measurement Solution	21011	100 ml	Solution	Protein Quantification	₹23,520	1 year	B
	4	SMART™ BCA Protein Assay Kit	21071	2,500 Test	Solution	Protein Quantification	₹23,520	2 years	RT
	5	GangNam Stain™ Prestained Protein Ladder (3 Colors)	24052	250 ul	Solution	Protein Marker	₹15,360	2 years	D
	6	Miracle-Star™ Western Blot Detection System	16028	200 ml	Solution	Western Blot Sol.	₹23,520	2 years	B
	7	Fast-One Blocker (Blocking Solution and Signal Enhancer)	16174	500ML	Solution	Western Blot.	₹22,800	1 year	B
	8	NomeIRT™ Western Blot Stripping Buffer	21112	500 ml	Strip ping buffer	Western Blot.	₹22,800	X	RT
PCR	1	i-Taq™ DNA Polymerase with Buffer, dNTPs.	25021	250 Units	Solution	General PCR	₹12,240	2 years	D
			25022	500 Units			₹20,880	2 years	D
	2	i-StarTaq™ DNA Polymerase with Buffer, dNTPs.	25161	250 Units	Solution	General PCR, Hot- Start	₹17,520	2 years	D
			25162	500 Units			₹33,120	2 years	D
	3	i-pfu DNA Polymerase with Buffer, dNTPs.	25181	250 Units	Solution	General PCR, High Fidelity	₹30,480	2 years	D
	4	i-MAX™ II DNA Polymerase with Buffer, dNTPs.	25261	250 Units	Solution	Long, High Fidelity	₹22,800	2 years	D
5	i-StarMAX™ II DNA Polymerase with Buffer, dNTPs.	25173	250 Units	Solution	Hot-Start, Long, High Fidelity	₹28,800	2 years	D	
6	Maxime™ PCR PreMix Kit (i-Taq), 20 ul	25025	96 Tubes (20ul)	PreM ix PCR Tube	General PCR	₹13,920	2 years	D	

Part	NO	Product Name	Cat.No	Size	Type	Application	Price	Expy	Stor	
	7		25026	96 Tubes x 5ea	PreMix PCR Tube	General PCR	₹55,920	2 years	D	
	8	Maxime™ PCR PreMix Kit (i-StarTaq), 20 ul	25165	96 Tubes (20ul)	PreMix PCR Tube	General PCR, Hot-Start	₹17,520	2 years	D	
	9		25167	96 Tubes x 5ea	PreMix PCR Tube	General PCR, Hot-Start	₹75,120	2 years	D	
	10	Maxime™ PCR PreMix Kit (i-pfu), 20 ul	25185	96 Tubes	PreMix PCR Tube	General PCR, High Fidelity	₹25,200	2 years	D	
	11	Maxime™ PCR PreMix Kit (i-MAX II), 20 ul	25265	96 Tubes	PreMix PCR Tube	Long, High Fidelity	₹26,160	2 years	D	
	12	Maxime™ PCR PreMix Kit (i-StarMAX II), 20 ul	25281	96 Tubes	PreMix PCR Tube	Hot-Start, Long, High Fidelity	₹28,800	2 years	D	
	13	2X PCR Master mix Solution (i-Taq), 0.5 ml x 2vials	25027	1 ml	MasterMix Solution	General PCR	₹8,640	1.5 year	B	
	14	2X PCR Master mix Solution (i-Taq), 1 ml x 5vials	25028	5 ml	MasterMix Solution	General PCR	₹38,400	1.5 year	B	
	15	2X PCR Master mix Solution (i-StarTaq), 0.5 ml x 2vials	25166	1 ml	MasterMix Solution	General PCR, Hot-Start	₹11,280	1.5 year	B	
	16	2X PCR Master mix Solution (i-pfu), 0.5 ml x 2vials	25186	1 ml	MasterMix Solution	General PCR, High Fidelity	₹13,920	1.5 year	B	
	17	2X PCR Master mix Solution (i-MAX II), 0.5 ml x 2vials	25266	1 ml	MasterMix Solution	Long, High Fidelity	₹13,920	1.5 year	B	
	18	2X PCR Master mix Solution (i-StarMAX II), 0.5 ml x 2vials	25174	1 ml	MasterMix Solution	Hot-Start, Long, High Fidelity	₹15,600	1.5 year	B	
	RT-PCR	1	Maxime™ RT PreMix Kit (Oligo dT Primer), 20 ul	25081	96 Tubes	PreMix PCR Tube	cDNA Synthesis, Premix	₹23,520	1 year	D
		2	Maxime™ RT PreMix Kit (Random Primer), 20 ul	25082	96 Tubes	PreMix PCR Tube	cDNA Synthesis, Premix	₹23,520	1 year	D
		3	Maxime™ RT-PCR PreMix Kit, 20 ul	25131	96 Tubes	PreMix	RT-PCR, Hot-Start	₹40,080	1 year	D

Part	NO	Product Name	Cat.No	Size	Type	Application	Price	Expy	Stor	
					PCR Tube					
	4	ONE-STEP RT-PCR PreMix Kit	25101	50 rxn.	Solution	RT-PCR, Hot-Start	₹28,800	1 years	D	
	5	HiSenScript™ RH(-) RT PreMix kit	25087	96 tubes	PreMix PCR Tube	cDNA Synthesis, Premix	₹28,800	1 year	D	
	6	HiSenScript™ RH(-) RT-PCR PreMix Kit	25135	96 tubes	PreMix PCR Tube	RT-PCR Premix	₹46,320	1 year	D	
	7	Power cDNA Synthesis Kit	25011	30 rxn.	Solution	General cDNA Synthesis	₹38,400	1 year	D	
Real-time	1	RealMOD™ Green W ² 2x qPCR mix	25350	100 rxn.	MasterMix Solution	Quantitative PCR	₹15,600	1 year	D	
	2	RealMOD™ Probe W ² 2x qRT-PCR mix	25352.1	100 rxn.	MasterMix Solution	Quantitative qRT-PCR	₹28,800	1 year	D	
			25352.5	500 rxn.			₹104,640	1 year	D	
			25352.1	1000 rxn.			₹174,480	1 year	D	
	3	RealMOD™ Probe M ² 2X qRT-PCR mix	25358.1	100 rxn.	MasterMix Solution	Quantitative qRT-PCR	₹28,800	1 year	D	
			25358.5	500 rxn.			₹104,640	1 year	D	
			25358.1	1000 rxn.			₹174,480	1 year	D	
	Cell Culture	1	iN-fect™ In vitro transfection reagents	15081	500ul	Solution	Transfection	₹34,800	1 years	B
		2	NO (Nitric Oxide) Plus Detection kit	21023	≤ 1000 assay	Solution	Nitric Oxide Detection	₹38,400	6 months	B
3		e-Myco™ Mycoplasma PCR Detection Kit (ver.2.0)	25235	48 Tubes	PreMix PCR Tube	Mycoplasma detection	₹52,320	1.5 year	D	
4		e-Myco™ plus Mycoplasma PCR Detection Kit	25237	48 Tubes	PreMix PCR Tube	Mycoplasma detection	₹61,200	1.5 year	D	
5		e-Myco™ VALiD Mycoplasma PCR Detection Kit	25239	48 Tubes	PreMix PCR Tube	Mycoplasma detection	₹61,200	1.5 year	D	
6		e-Myco™ VALiD-Q Mycoplasma qPCR Detection Kit	25245	50 Tests	Real-time Solution	Mycoplasma detection	₹174,480	1.5 year	D	
7		e-Myco™ VALiD-Q ² Mycoplasma qPCR Detection Kit	IP24421	48 Tubes	Real-time Premix	Mycoplasma detection	₹174,480	1 year	D	

Part	NO	Product Name	Cat.No	Size	Type	Application	Price	Expy	Stor
Others	8	MycoClean™ Mycoplasma Prevention Spray	21083	200ml	solution	Mycoplasma Removal	₹10,560	2 years	RT
	1	pLUG-Prime® TA-cloning Vector Kit II	11063	20 rxn.	Solution	TA Cloning	₹34,800	2 year	D
	2	LPS Extraction Kit	17141	100 rxn.	Solution	Lipoplysaccharides Prep	₹38,400	1 year	B
	3	RedSafe™ Nucleic Acid Staining Solution	21141	1ml	Solution	EtBr Alternative	₹12,240	2 years	RT
	4	Agarose LE	32034	500 g	Powder	Routine Analysis, Biotting	₹96,000	x	RT
	5	dNTP Mixture	32292	2.5 mM/each(2 ml)	Tube	PCR	₹23,520	1 year	D
	6	SiZer™-100 DNA Marker Solution	24073	0.5 ml	Solution	DNA Size Marker	₹13,920	2 years	D
	7	SiZer™-1000 DNA Marker Solution	24074	0.5 ml	Solution	DNA Size Marker	₹12,240	2 years	D
Buffers	8	SiZer™-1000 plus DNA Marker Solution	24075	0.5 ml	Solution	DNA Size Marker	₹15,600	2 years	D
	1	G-DEX IIb RBC Lysis Buffer	172R-1000	1 L	Solution	Genomic DNA buffer	₹22,800	2 years	RT
	2	G-DEX II Cell Lysis Buffer	172C-1000	1 L	Solution	Genomic DNA buffer	₹63,600	2 years	RT
	3	G-DEX II Protein PPT Buffer	172P-0350	350ml	Solution	Genomic DNA buffer	₹57,600	2 years	RT
	4	G-DEX II DNA Rehydration Buffer	172D-0500	500ml	Solution	Genomic DNA buffer	₹38,400	2 years	RT
	5	DNA-spin Lysis buffer	17097L-500	500 ml	Solution	Plasmid DNA buffer	₹28,800	2 years	RT
	6	DNA-spin Neutralization Buffer	17097N-500	500 ml	Solution	Plasmid DNA buffer	₹28,800	2 years	RT
Column	7	MEGAquick-spin plus Agarose Lysis Buffer	17290L-500	500 ml	Solution	Plasmid DNA buffer	₹32,640	2 years	RT
	1	DNA-spin(Column only)	17097C	500ea	Column	Plasmid DNA column	₹76,800	x	RT
	2	MEGAquick-spin plus (Column only)	17290C	500ea	Column	Plasmid DNA column	₹76,800	x	RT
	3	G-spin series Column + Collection tube	17000GC	500ea	Column, Tube	Genomic DNA column	₹86,400	x	RT
	4	i-genomic series Column + Collection tube (CAPS)	C170001C	500ea	Column, Tube	Genomic DNA column	₹174,480	x	RT

Part	NO	Product Name	Cat.No	Size	Type	Application	Price	Expy	Stor
	5	RNA series Column + Collection tube (CAPS)	C17000 RC	500ea	Column, Tube	RNA series column	₹211,200	x	RT

Premade Buffer – Intron Biotechnology			
Cat No.	Product Name	Application	Price
BA001	7.5M Ammonium Acetate	250ml	18915
BA002	ACRYLAMIDE 40% ULTRA PURE	500ml	21304
BA003	Acrylamide-Bis Solution 40% , 19:1	500ml	22328
BA003-1	Acrylamide-Bis Solution 40% , 29:1	500ml	22328
BA004	Acrylamide-Bis Solution 30% , 29:1	500ml	22328
BA004-1	Acrylamide-Bis Solution 30% , 19:1	500ml	22328
BA005	Acrylamide-Bis Solution 40% , 37.5:1	500ml	22328
BA005-1	Acrylamide-Bis Solution 30% , 37.5:1	500ml	22328
BA006	6X Agarose gel loading buffer Type I	10ml	19598
BA007	6X Agarose gel loading buffer Type II	10ml	19598
BA008	6X Agarose gel loading buffer Type III	10ml	19598
BA009	6X Agarose gel loading buffer Type IV	10ml	19598
BA010	Alkaline Lysis Solution I	500ml	20280
BA011	Alkaline Lysis Solution II	500ml	19598
BA012	Alkaline Lysis Solution III	500ml	20963
BA013	10% Ammonium persulfate solution	10ml	18574
BA014	10x Anode buffer	500ml	24034
BA015	Alkaline transfer buffer	500ml	19256
BA016	Agarose Triple dye	10ml	19598
BA017	1x Anode buffer	5L	26423
BA018	Acetate Buffer pH 5.5	500ml	19598
BA019	0.2M Ammonium Bicarbonate Buffer Solution, pH 8.2.	1000ml	19598
BA020	1M Arginine HCL-pH 3.2	1000ml	27788
BA021	ampicillin (100mg/ml)	20ml	23010
BA022	Akaline solution for comet assay	1000ml	22328
BB001	1 X BBS	500ml	18574
BB002	2 X BBS	500ml	18915
BB003	5 X Binding Buffer	100ml	20621
BB004	Bis-acrylamide 2% SOLUTION	100ml	18915
BB005	Blocking buffer	500ml	22328
BB006	BSA(100mg/ml)	5ml	23010
BB007	50mM Boric Acid, 4M Sodium Chloride Buffer pH8.0	1000ml	19598
BB008	10X Borate Saline Buffer	1000ml	20963
BB009	1X Borate Saline Buffer	1000ml	19598
BC001	Calcium Chloride <i>E.coli</i> Transformation Buffer	250ml	19939
BC002	1M Calcium Chloride Solution	500ml	19598
BC003	CHURCH Buffer	1000ml	21645
BC004	0.1M Citric Acid	500ml	18915
BC004-1	10mM Citrate buffer	500ml	18915
BC005	Coomassie Blue G-250 Staining solution	1000ml	21645
BC005	Coomassie Blue G-250 Staining solution	5L	33930
BC006	Coomassie Blue R-250 Staining solution	1000ml	21645
BC006	Coomassie Blue R-250 Staining solution	5L	33930

Premade Buffer – Intron Biotechnology			
Cat No.	Product Name	Application	Price
BC007	CTAB Extraction Solution	250ml	19598
BC008	10x Cathode buffer	500ml	23693
BC009	ChIP dilution buffer	100ml	20280
BC010	Chloroform-IAA	500ml	22328
BC011	1x Cathode buffer	5L	26423
BC012	Coating Buffer	1000ml	21645
BC013	10x carbonate Coating Buffer	100 ml	21645
BC014	3X Citrate Buffered Saline pH 5.5	1000ml	20280
BC015	CHAP Equalibration Buffer	1000ml	19598
BC016	Carbenicillin, (100mg/ml, Ethanol)	1ml	34613
BC017	chloramphenicol, 100 mg/mL in ethanol: IPA (95:5)	10 ml	20963
BC018	1M Citric acid	1000ml	22328
BD001	100X Denhards Solution	50ml	22328
BD002	10X DEA Buffer	100 ml	22328
BD003	10X Denaturing Solution	1000ml	19598
BD004	10X Detection Buffer	1000ml	20280
BD005	10X DIG Washing Buffer	100ml	19256
BD006	Denaturing Solution I	500ml	18915
BD007	Denaturing Solution II	1000ml	46215
BD008	Diluent	100ml	19598
BD009	DNA-PAGE 10% (19:1) ULTRA PURE	250ml	19939
BD010	DNA-PAGE 12% (19:1) ULTRA PURE	250ml	19939
BD011	DNA-PAGE 20% (19:1) ULTRA PURE	250ml	19939
BD012	DNA-PAGE 4% (19:1) ULTRA PURE	250ml	19939
BD013	DNA-PAGE 6% (19:1) ULTRA PURE	250ml	19939
BD014	DNA-PAGE 8% (19:1) ULTRA PURE	250ml	19939
BD015	DNase I Buffer	10ml	18574
BD016	Destaining solution for SDS PAGE	1000ml	19256
BD016	Destaining solution for SDS PAGE	5L	24375
BD017	1M DTT	50ml	25740
BD019	DNA Suspension Buffer (T10E0.1, BT010)	500ml	18915
BE001	200mM EDTA, pH 8.0	500ml	18915
BE002	500mM EDTA, pH 8.0	500ml	19939
BE002	500mM EDTA, pH 8.0	1L	21850
BE003	Ethidium Bromide Solution	20ml	20963
BE004	1M EGTA, pH 8.0	10ml	23693
BE005	EC Lysis buffer	1000ml	22328
BE006	Enzymeatic lysis buffer	500ml	19939
BR007	Elution buffer for qiagen	500ml	20621
BE008	1M EDTA, pH 8.0	500ml	24375
BE009	500mM EDTA, pH 7.5.	500ml	20280
BE009a	500mM EDTA, pH 7.4	500ml	20280
BE010	Electroblot Buffer	1000ml	19939
BE011	Electroporation buffer	100ml	20963
BE012	Electroporation buffer (E buffer)	1000ml	20963
BE013	ERK Lysis buffer	100ml	20963
BF001	10 X Ficoll Loading Buffer	10ml	20621
BF003	80% Formamide Loading Buffer	10ml	19598

Premade Buffer – Intron Biotechnology			
Cat No.	Product Name	Application	Price
BF004	100% Formamide Loading Buffer	10ml	19598
BF005	Formamide Loading Buffer	10ml	19598
BF006	Formamide Stop/Loading Buffer I	10ml	19598
BF007	Formamide Stop/Loading Buffer II	10ml	19598
BF008	Ficoll 400 solution, 2%	100ml	20963
BF009	Factor Xa reaction buffer	500ml	21645
BF010	5 x First Strand Buffer Solution	500ml	23693
BF011	1M FeSO4	500ml	20963
BG001	20% Galactose Solution	100ml	22328
BG002	GTE	500ml	20280
BG003	20% Glucose Solution	250ml	19598
BG004	40% Glucose Solution	250ml	20280
BG005	10 X Glycerol Loading Buffer	10ml	19598
BG006	50% Glycerol Solution	250ml	20280
BG006-1	80% Glycerol solution	500ml	23693
BG007	7M Guanidine HCl Solution	500ml	32565
BG008	2% Gelatin solution	10ml	18574
BG009	6M Guanidine Thiocyanate Buffer	1000ml	43485
BG010	Gel Shift Loading Buffer	10 ml	20280
BG011	15% Glycerol Electroporation Buffer w/ 272 mM Sucrose	1000ml	20280
BG012	Gel Loading Buffer, Modified	20 ml	19598
BG013	Gel Drying Solution.	1000ml	23010
BG014	50X GBS PCR Buffer,	500mL	21645
BG015	25% Glutaraldehyde	100ml	20963
BH001	Hybridization Solution I	1000ml	20621
BH002	Hypotonic Lysis Buffer	1000ml	23010
BH003	1M HEPES , pH 7.0	500ml	26423
BH004	1M HEPES , pH 7.5	500ml	26423
BH005	10mM HEPES buffer	100ml	19598
BH006	Hybridization Solution w/ formamide	500ml	31200
BH007	Hybridization Solution w/o formamide	500ml	22328
BH008	HEP buffer	1000ml	20963
BH009	HEPA buffer	1000ml	22328
BH010	2x HEPES buffer, pH x.x	500ml	23693
BH011	10x HBSS Cell culture	1000ml	20963
BH012	0.5M HEPES, pH 7.5	500ml	24375
BH013	50mM HEPES Assay Diluent. pH 7.5,	1000ml	23351
BH014	HPLC Buffer	1000ml	20963
BH015	10 x HEPES Buffer A Solution	500ml	21986
BH016	5 x HEPES Buffer B Solution	100ml	22669
BH017	5N HCl	1000ml	19256
BI001	IPTG solution (0.1M)	20ml	20280
BI002	IP Binding Buffer, Protein A/G	500ml	22328
BI003	IP Elution Buffer, Protein A/G	500ml	22328
BI004	1M Imidazol solution, pH 8.0	500ml	20963
BI005	2M Imidazole, pH 7.5	500ml	23693
BI006	2.5M Imidazole	500ml	25058
BK001	kanamycin	20ml	23010

Premade Buffer – Intron Biotechnology			
Cat No.	Product Name	Application	Price
BL001	4M Lithium Chloride	100ml	19939
BL002	Lysis buffer for luciferase assay 5x	50ml	22328
BL003	1m Lithium acetate	100ml	18915
BL004	Lysozyme(10mg/ml)	10ml	19256
BL005	L-Buffer	1000ml	21099
BM001	1M Magnesium Chloride	500ml	24375
BM002	1M Magnesium Sulfate Solution	500ml	23010
BM003	10 X MOPS Buffer	1000ml	27105
BM004	5 x MTBE	1000ml	19256
BM005	MES buffer, pH 6.1, 1 M	500ml	24375
BM006	MOPS buffer, pH 7.2, 1.0 M	500ml	24375
BM007	0.1M MES buffer	1000ml	24375
BM008	20 x MOPS/SDS Running Buffer	500ml	25740
BM009	0.5M MES buffer, pH 6.1.	500ml	23010
BM010	MES SDS Running Buffer.	500ml	25740
BM011	25mM Magnesium chloride	250ml	19598
BM012	50mM Magnesium Chloride	250ml	20280
BM013	30mM MES Buffer pH 6.5	1L	22328
BM014	10 x MOPS Sodium Acetate Solution	500 ml	22669
BM015	0.1M MES buffer, pH 4.5.	1000ml	24375
BM016	500 mM MOPS, pH 7.4	500 ml	21986
BM017	Methyl Green-Pyoin Solution	50ml	21645
BM018	10% Maltose		
BN001	Neutralization buffer, pH 7.4	500ml	19256
BN002	0.16M Nitric Acid	100ml	19256
BN003	Neutralization buffer I	1000ml	20963
BN004	Neutralization buffer II	500ml	20280
BN005	Neutralization buffer III	500ml	20280
BN006	0.1M Nickel Sulfate	1000ml	21645
BN007	Ni-NTA Denaturation Lysis buffer A	500ml	25740
BN008	Ni-NTA Denaturation Lysis buffer B	500ml	23693
BN009	Ni-NTA Denaturation Wash buffer C	500ml	23693
BN010	Ni-NTA Denaturation Elution buffer D	500ml	23693
BN011	Ni-NTA Denaturation Elution buffer E	500ml	23693
BN012	Ni-NTA Native Lysis buffer	500ml	21645
BN013	Ni-NTA Native Wash buffer	500ml	21645
BN014	Ni-NTA Native Elution buffer	500ml	21645
BN015	10% NP-40	500ml	20963
BP001	P1 solution for Qiagen Plasmid preparation	500ml	20280
BP002	P2 solution for Qiagen Plasmid preparation	500ml	19598
BP003	P3 solution for Qiagen Plasmid preparation	500ml	20621
BP004	1X PBS	1000ml	19939
BP004-1	1X PBS	5000ml	27105
BP005	1X PBS, Dulbecco's	500ml	19256
BP006	1X PBS, Tween 20, pH 7.4	1000ml	20280
BP006-1	1X PBS, Tween 20, pH 7.4	5000ml	28470
BP007	20X PBS	1000ml	21986
BP007	20X PBS	5000ml	35295

Premade Buffer – Intron Biotechnology			
Cat No.	Product Name	Application	Price
BP007a	10X PBS	1000ml	20963
BP007a	10X PBS	5000ml	31200
BP007b	10X PBS pH 7.3	1000ml	20963
BP008	30% PEG Solution	250ml	20621
BP009	PEG/ NaCl Solution for M13 phage DNA	250ml	20280
BP010	PEG/ NaCl Solution for plasmid DNA	250ml	20280
BP011	5M Potassium Acetate Solution	500ml	21645
BP012	3M Potassium Acetate Solution, pH 4.8	500ml	20963
BP012a	3M Potassium Acetate Solution, pH 5.5	500ml	20963
BP013	Potassium Acetate, Guanidine HCl Solution pH 4.8	500ml	33248
BP014	1M Potassium Chloride Solution	100ml	19256
BP015	2M Potassium Chloride Solution	100ml	19939
BP016	PROTEIN-PAGE-5% (29:1) stacking gel	250ml	20621
BP017	PROTEIN-PAGE-5% (37.5:1) stacking gel	250ml	20621
BP018	PROTEIN-PAGE-6% (29:1) resolving gel	250ml	20621
BP019	PROTEIN-PAGE-6% (37.5:1) resolving gel	250ml	20621
BP020	PROTEIN-PAGE-8% (29:1) resolving gel	250ml	20621
BP021	PROTEIN-PAGE-8% (37.5:1) resolving gel	250ml	20621
BP022	PROTEIN-PAGE-10% (29:1) resolving gel	250ml	20621
BP023	PROTEIN-PAGE-10% (37.5:1) resolving gel	250ml	20621
BP024	PROTEIN-PAGE-12% (29:1) resolving gel	250ml	20621
BP025	PROTEIN-PAGE-12% (37.5:1) resolving gel	250ml	20621
BP026	Phenol/CHCl ₃ /IAA	500ml	23693
BP027	Phenol saturated for DNA, pH8.0	500ml	23693
BP028	Phenol saturated for RNA, pH4.5	500ml	23693
BP029	protenase K solution(20mg/ml)	5ml	29153
BP030	PIPES buffer, pH 6.8, 1 M	500ml	29835
BP031	Paraformaldehyde 4%, /PBS	1000ml	24375
BP032	Prehybrization/Hybridization Solution	500ml	23351
BP033	Potassium Acetate, 8M, pH8.0	100ml	21645
BP034	1M Potassium Phosphate, Monobasic	1000ml	21167
BP035	1M Potassium Phosphate, Dibasic	1000ml	21167
BP036	0.01M PBS Buffer with 0.01% Tween-80, pH 7.5,	500 ml	19256
BP037	0.01M PBS Buffer with 0.01% TWEEN 80, pH 7.5,	1000 ml	20621
BP038	1X PBS Solution, 0.05M NaCl, pH 7.4.	1000ml	19939
BP039	1X PBS Solution with 0.05% Tween-20 (pH 7.4).	1000ml	20280
BP040	1X PBS with EDTA, pH 7.4 Solution	1000ml	19939
BP041	1X PBS Solution pH 7.2.	1000ml	19939
BP042	1X PBS Solution pH 7.5	1000ml	19939
BP043	1 X PBS with 0.05% Sodium Azide,	1000ml	20621
BP044	1X PBS with 0.1% Tween 20.	1000ml	20280
BP045	1X PBS with 1% Tween 20.	1000ml	20280
BP046	1X PBS-TBN Buffer	1000ml	20280
BP047	1X PBS with 0.1% Tween 80.	1000ml	20280
BP048	1X PBS-TBN Buffer with 0.05% Tween,1% BSA, 0.1% Sodium Azide.	1000ml	24375
BP049	1X PBS Solution, 0.05M NaCl, pH 2.6	1000ml	20280
BP050	1X PBS with 2% Sodium Citrate, pH 7.6	500 ml	19939
BP051	1X PBS with 1% BSA,	1000ml	21645

Premade Buffer – Intron Biotechnology			
Cat No.	Product Name	Application	Price
BP052	10X DPBS without Calcium and Magnesium. pH 7.4	500ml	19939
BP053	10X DPBS with Calcium, Magnesium.	500ml	19939
BP054	10X DPBS Tween 20, pH 7.4	1000ml	22328
BP055	20 x PBS with 0.1% Tween 20. pH 7.5	1000ml	22123
BP056	20X PBS with 2% Tween-20	1000ml	22328
BP057	20X PBS, pH 7.9.	1000ml	21986
BP058	10X PBS with 0.5% Tween 20, pH 7.4.	1000ml	20963
BP059	5X PBS-TBN Buffer	1000ml	20963
BP060	10 x PCR Buffer.	5ml	21645
BP061	20mM Phosphate with 0.9% Saline, pH 7.0.	1000ml	19939
BP062	PBSF Buffer	1000ml	23010
BP063	PBSM Buffer.	1000ml	25740
BP064	Phage Lysis Buffer	1000ml	20280
BP065	20X PBS with 1% Tween-20	1000ml	21986
BP066	17% Phosphoric Acid	500mL	20280
BP067	3% Potassium Hydroxide Solution	100 mL	19256
BP068	1X Dulbecco's Phosphate Buffered Saline in 5% BSA.	1000ml	24375
BP069	1X Dulbecco's Phosphate Buffered Saline in 0.5% BSA.	1000ml	21645
BP070	1M Potassium Glutamate Solution	1000ml	21645
BP071	PPB Solution	1000ml	21986
BP072	0.04% Phenol Red Solution	100 ml	21645
BP073	16.67% PEG / 3.33M NaCl solution	1000ml	23010
BP074	50mM Potassium Phosphate pH x.x	250ml	19598
BP075	0.1M PBS Solution	1000ml	20963
BP076	Ponceau S Solution	1000ml	25058
BP077	pH Standard Solution pH 10.0	500ml	23010
BP078	1M Potassium Phosphate pH x.x	500ml	20280
BP079	PNPP Solution	500ml	29835
BP080	16% Paraformaldehyde	500ml	29835

Category	SI	Cat #	PCR type	Product Name	Appli cation	Target gene	Size	Price- INR
Virus	1	IP11002	PCR	Avian leukosis virus (ALV)	Avian	env gene	48T	28980
	2	IP11283	PCR	Infectious laryngotrachitis virus (ILTIV)	Avian	glycoprotein	48T	28980
	3	IP12283	RT-PCR	Infectious bursal disease virus (IBDV)	Avian	VP2	48T	30450
	4	IP12284	RT-PCR	Infectious bronchitis virus (IBV)	Avian	N gene	48T	30450
	5	IP12456	RT-PCR	Newcastle disease virus - common & patho (NDV)	Avian	F1/F2	24T	33390
	6	IP13421	Nested-PCR	Marek disease virus (MDV)	Avian	Meq	24T	28980
	8	IP12036	RT-PCR	Bovine Coronavirus	Bovine	HE	48T	30450
	9	IP12037	RT-PCR	Bovine Coronavirus/rotavirus/diarrhea disease virus	Bovine	HE/VP7/ 5'UTR	50T	44940
	10	IP12038	RT-PCR	Bovine ephemeral fever virus + Bluetongue virus (BEFV/BTV)	Bovine	N protein / VP3	48T	33390
	11	IP12039	RT-PCR	Bovine Rotavirus (BRV)	Bovine	VP7	48T	30450
	12	IP12040	RT-PCR	Bovine viral Diarrhea disease virus (BVDV)	Bovine	5'UTR	48T	30450

Category	SI	Cat #	PCR type	Product Name	Appli- cation	Target gene	Size	Price- INR
	13	IP11072	PCR	Chicken anemia virus (CAV)	Canine	VP2	48T	28980
	14	IP11073	PCR	Canine Herpesvirus (CHV)	Canine	gB gene	48T	28980
	15	IP11074	PCR	Canine parvovirus (CPV)	Canine	VP2	48T	31920
	16	IP12071	RT-PCR	Canine coronavirus (CCoV)	Canine	S gene	48T	30450
	17	IP12072	RT-PCR	Canine parainfl-uenza virus (CPIV)	Canine	F gene	48T	30450
	18	IP12598	RT-PCR	Rabies virus (RV)	Canine	N gene	48T	30450
	19	IP13071	Nested-PCR	Canine distemper virus (CDV)	Canine	H gene	24T	30450
	20	IP11176	PCR	Feline herpesvirus (FHV)	Feline	TK gene	48T	28980
	21	IP11177	PCR	Feline immunodeficiency virus (FIV)	Feline	gag gene	48T	28980
	22	IP12176	RT-PCR	Feline Coronavirus (FCoV)	Feline	S gene	48T	30450
	23	IP12177	RT-PCR	Feline calicivirus (FCV)	Feline	VP2	48T	30450
	24	IP12178	RT-PCR	Feline leukemia virus (FeLV)	Feline	Envelope precursor	48T	30450
	25	IP12281	RT-PCR	Influenza virus FluA-2 (2009 H1N1)	Human	18s rRNA/ New H1	48T	33390
	26	IP12597	RT-PCR	Rotavirus (Rota)	Human	VP4 / VP7	48T	33390
	27	IP13141	Nested-PCR	Enterovirus (EV-VP1) 1st	Human	VP1	48T	30450
	28	IP13142	Nested-PCR	Enterovirus (EV-VP1) 2nd	Human	VP1	48T	28980
	29	IP13246	Nested-PCR	Hemorrhagic fever with renal syndrome (Hantaanvirus/ Seoulvirus / Puumalavirus)	Human	NP	48 T	39165
	30	IP13316	Nested-PCR	Japanese Encephalitis virus 1st (JEV)	Human	polyprotein gene	48T	30450
	31	IP13317	Nested-PCR	Japanese Encephalitis virus 2nd (JEV)	Human	polyprotein gene	48T	28980
	32	IP15316	Real-Time RT-PCR	Japanese Encephalitis virus & West Nile (JEV/ WNV)	Human	polyprotein	50T	47775
	33	IP14841	Real-Time RT-PCR	Yellow fever virus & Dengue virus (YFV/DENV)	Human	polyprotein	50T	47775
	34	IP11527	PCR	Porcine Circovirus type 2 (PCV2)	Porcine	ORF2	48T	28980
	35	IP12526	RT-PCR	Porcine reproductive & respiratory syndrome virus (PRRS)	Porcine	N gene	48T	30450
	36	IP12632	RT-PCR	Swine in-uenza virus (NP) (SIV)	Porcine	NP gene	48T	30450
	37	IP12633	RT-PCR	Swine in-uenza virus typing (SIV-H1/H3/N1/N2)	Porcine	18s/H1/H3/ N1/N2/M/NP	48T	36225
	38	IP12666	RT-PCR	Transmissible gastroenteritis & Porcine epidemic diarrhea virus (TGE/PED)	Porcine	S gene / M gene	48T	33390
	39	IP14002	Real-Time RT-PCR	Swine-Origin Influenza virus (S-OIV-M/NP)	Porcine	M/NP	50T	44940
	40	IP14003	Real-Time RT-PCR	Swine-Origin Influenza virus typing (S-OIV-Eurasian SIV/M/H1/NA)	Porcine	Eurasian SIV/M/H1/NA	50T	44940
	41	IP12527	RT-PCR	Potato Leaf Roll Virus (PLRV)	Potato	CP gene	48T	30450
	42	IP12528	RT-PCR	Potato Spindle Tuber Viroid (PSTVd)	Potato	complete genome	48T	30450
	43	IP12530	RT-PCR	Potato Virus S (PVS)	Potato	CP gene	48T	30450
	44	IP12531	RT-PCR	Potato Virus X (PVX)	Potato	CP gene	48T	30450
	45	IP12532	RT-PCR	Potato Virus Y (PVY)	Potato	CP gene	48T	30450

Category	SI	Cat #	PCR type	Product Name	Appli cation	Target gene	Size	Price- INR
	46	IP15036	Real-Time RT-PCR	Bovine Viral Diarrhea Virus (BVDV) NEW	Bovine	BVDV 1 & 2	50 T	44940
	47	IP15037	Real-Time RT-PCR	Porcine reproductive & respiratory syndrome virus (PRRS, EU & NA) NEW	Porcine	N gene	25 T	44940
	48	IP12599	RT-PCR	Rice Virus Multiplex (RSV, RBSDV, RDV) NEW	Rice	NP gene / CP gene	48 T	32235
Bacteria	1	IP21071	PCR	Campylobacter coli, jejuni, lari (CAMPY)	Avian	23s rRNA / lpxA	48T	34755
	2	IP21421	PCR	Mycoplasma gallisepticum & Mycoplasma synoviae (MG/MS)	Avian	16s rRNA	48T	31920
	3	IP21036	PCR	Bacillus anthracis (Anthrax)	Bovine	Capsule / PA	48T	31920
	4	IP21039	PCR	Blackleg	Bovine	16s rRNA	48T	28980
	5	IP21426	PCR	Mycoplasma Tuberculosis (TB)	Bovine	16s rRNA	48T	28980
	6	IP21427	PCR	Mycoplasma Tuberculosis duplex (TB-duplex)	Bovine	IS6110/ IS1081	48T	31920
	7	IP21428	PCR	Mycoplasma Tuberculosis multi (TB-multi)	Bovine	16s rRNA/IS6110 /IS1081	48T	34755
	8	IP21037	PCR	Babesia canis & B. gibsoni (BAB-C)	Canine	18s rRNA	48T	28980
	9	IP21041	PCR	Brucella spp. (BRU)	Canine	omp gene	48T	28980
	10	IP21073	PCR	Clostridium perfringens (CLOS)	Canine	cpa	48T	28980
	11	IP21386	PCR	Leptospira spp. (LEPTO)	Canine	16s rRNA	48T	28980
	12	IP21143	PCR	Ehrlichia spp. (EHR)	Canine	16s rRNA	48T	28980
	13	IP21422	PCR	Mycoplasma haemocanis (HBN-C)	Canine	16s rRNA	48T	28980
	14	IP21425	PCR	Mycoplasma spp. (Myco)	Canine	16s rRNA	48T	28980
	15	IP21631	PCR	Salmonella spp. (SAL)	Canine	invA	48T	28980
	16	IP21072	PCR	Chlamydia psittaci (CHLA)	Feline	ompA gene	48T	28980
	17	IP21423	PCR	Mycoplasma haemofelis (HBN-F)	Feline	16s rRNA	48T	28980
	18	IP21666	PCR	Toxoplasma gondii (TOXO)	Feline	B1 gene	48T	28980
	19	IP21001	PCR	Avian pathogenic Escherichia coli (APEC)	Porcine	fyuA / irp2	48T	31920
	20	IP21424	PCR	Mycoplasma hyopneumoniae (Myco-P)	Porcine	ldh gene	48T	28980
	21	IP21526	PCR	Pasteurella multocida (PAS)	Porcine	KMT1	48T	28980
	22	IP21527	PCR	Pasteurella multocida type A (PAS-A)	Porcine	PmHAS	48T	28980
	23	IP21528	PCR	Pasteurella multocida type D (PAS-D)	Porcine	hssA	48T	28980
	24	IP21736	PCR	Vibrio spp. (VIBRIO)	Shrimph	16s rRNA	48T	28980
Para site	1	IP31456	PCR	Neospora caninum (Neospora)	Bovine	ITS	48T	28980
	2	IP31246	PCR	Heart worm (HW)	Canine	16s rRNA	48T	28980
Fungi	1	IP41001	PCR	Aspergillus spp. (ASP)	Canine	alk gene	48T	28980
Veterinary & Avian Diagnostics	1	IPC11002	RT-PCR	Avian influenza virus (AIV common duplex)	Avian	M/NS gene	96T	42000
	2	IPC11003	RT-PCR	Avian influenza virus serotype H5 (AIV H5-1)	Avian	H5 gene	96T	39690
	3	IPC11005	RT-PCR	Avian influenza virus serotype H7 (AIV H7-1)	Avian	H7 gene	96T	39690
	4	IPC11007	RT-PCR	Avian influenza virus serotype H9 (AIV H9-1)	Avian	H9 gene	96T	39690
	5	IPC11009	RT-PCR	AIV Multi-tube Detection Kit	Avian	18s/M/NP/ H5/H7/H9	12T	47775

Category	SI	Cat #	PCR type	Product Name	Appli cation	Target gene	Size	Price- INR
	6	IP15001	Real-Time RT-PCR	AIV Real-Time RT-PCR Screening kit NEW	Avian	M/NP gene	50T	53550
	7	IP15002	Real-Time RT-PCR	AIV H5/H7/H9 Real-Time RT-PCR Detection kit NEW	Avian	Hemagglutinin gene	50T	53550
	8	IPC11020	Nested-PCR	Aino virus (Aino) 1st Detection Kit	Bovine	NSs gene	96T	42000
	9	IPC11021	Nested-PCR	Aino virus (Aino) 2nd Detection Kit	Bovine		96T	39690
	10	IPC11022	Nested-PCR	Akabane virus (Akabane) 1st Detection Kit	Bovine	NSs gene	96T	42000
	11	IPC11023	Nested-PCR	Akabane virus (Akabane) 2nd Detection Kit	Bovine	NSs gene	96T	39690
	12	IPC11024	Nested-PCR	Bovine ephemeral fever virus (BEFV) 1st Detection Kit	Bovine	N protein	96T	42000
	13	IPC11025	Nested-PCR	Bovine ephemeral fever virus (BEFV) 2nd Detection Kit	Bovine	N protein	96T	39690
	14	IPC11027	Nested-PCR	Chuzan virus (Chuzan) 1st Detection Kit	Bovine	NS1	96T	42000
	15	IPC11028	Nested-PCR	Chuzan virus (Chuzan) 2nd Detection Kit	Bovine	NS1	96T	39690
	16	IPC11029	Nested-PCR	Ibaraki virus (Ibaraki) 1st Detection Kit	Bovine	VP3	96T	42000
	17	IPC11030	Nested-PCR	Ibaraki virus (Ibaraki) 2nd Detection Kit	Bovine	VP3	96T	39690
	18	IPC11083	Real-Time RT-PCR	Foot-and-mouth virus Real-time RT-PCR Detection Kit (FMDV)	Porcine	5'UTR	50T	44940
	19	IPC11011	RT-PCR	Foot-and-mouth virus RT-PCR Detection Kit (FMDV)	Porcine	5'UTR	48T	39690
	20	IPC11040	Nested-PCR	Tsutsugamushi Detection Kit (TSUTSU)	Human	56kDa	96T	42000

i-Taq™ DNA Polymerase



High-purity i-Taq™ PCR core kit that displays stable and efficient DNA amplification regardless of template type and reaction conditions

- 94 KDa thermostable DNA polymerase
- High purity Taq DNA Polymerase
- Removal of E. coli -derived proteins and DNA that may act as PCR sources
- Applicable to DNA from cloned DNA to human genomic DNA
- Buffer optimization to show the best

polymerase activity regardless of template type or reaction conditions

i-Taq™ DNA Polymerase is a thermostable DNA polymerase of 94 kDa, which is expressed in E. coli by cloning the polymerase gene of *Thermus aquaticus* (strain YT1). It removes the E. coli-derived protein and DNA which can act as a contaminant in PCR. It is stable and efficient DNA amplification product. Genomic DNA, cDNA, etc. can be amplified up to 5 Kb. PCR (Polymerase Chain Reaction) is a method of amplifying a desired DNA molecule in a test tube by specifically repeating synthesis of a specific DNA site. As a result, it is possible to synthesize a large amount of DNA using a very small amount of DNA. Of course, it is widely used in the fields of basic biology, medicine, and biology. We are now expanding the scope of its use in the fields of forensic medicine, food, environmental hygiene, and animal and plant inspection in a simple and quick way. DNA polymerase chain reaction can amplify DNA of specific site in a few hours up to 10^5 - 10^8 times in vitro. The amplified DNA can be used for various experiments as follows. Based on the experimental results, various medical researches can be applied to. In the early days when this method was developed, PCR was performed using *Escherichia coli* DNA Polymers, so it was necessary to supplement DNA polymerase of denatured *Escherichia coli* at every denaturation. However, by using the thermostable DNA Polymerase isolated from *Thermus aquaticus* in PCR, we did not have to do the

troublesome task of supplementing the enzyme every step. As a result, PCR became an indispensable method for molecular biology. PCR has a series of three steps and repeats 30 to 40 times.

The first step in the PCR is denaturation of the DNA, separating the two strands of DNA by heating. Each separated DNA serves as a template and the denaturation temperature depends on the amount and length of G + C in the DNA. The second step in PCR is annealing. At this stage, the primers bind to the template DNA and the annealing temperature is an important factor in determining the accuracy of the reaction. If the temperature is too high, the primers will bind too weakly to the template DNA, If the temperature is too low, undesirable DNA can be amplified because the primers bind nonspecifically. The third step in PCR is the elongation step. At this stage, heat-resistant DNA polymerase will make new DNA from the template DNA. i-Taq™ DNA Polymerase In addition to high purity enzymes, it is possible to obtain highly reproducible results by optimizing the buffer composition to exhibit the best polymerase activity irrespective of the type of template or half of the template. Since most of the products amplified with this enzyme have a base A at the 3-terminus, the PCR product can be cloned into a T-vector as it is. It can also be cloned into a blunt-end vector by phosphorylating it into a blunt end by filling it with a DNA polymerase such as Klenow DNA Polymerase or T4 DNA Polymerase.

Applications

- **01** Genomic DNA, cDNA are amplified to 5kb
- **02** T/A Cloning or Blunt-end Cloning

Kit Contents

Content	250 Units	500 Units
i-Taq™ DNA Polymerase (5U/ml)	250 units x 1 tube	500 units x 1 tube
10× PCR Buffer(w/20 mM MgCl ₂)	1 ml x 1 tube	1 ml x 1 tube
10× MgCl ₂ free PCR Buffer	1 ml x 1 tube	1 ml x 1 tube
10 mM dNTPs (2.5 mM/each)	500 µl x 1 tube	1 ml x 1 tube
25 mM MgCl ₂	1 ml x 1 tube	1 ml x 1 tube
Manual	1 ea	1 ea

Biochemistry / Diagnostics Reagents / Kits

Product ID	Description	Pack size	Price INR
Biochemistry & Immunoturbidimetry Range DIATEK-Greiner			
DIA-GRE-01	ACE	10x10ml + std	45000
DIA-GRE-02	Molecular Biology Alcohol / Ethanol	4x10/4x10ml+std	15625
DIA-GRE-03	ALP - DEA DGKC	5x20/2x10ml	2500
DIA-GRE-04	ALP - IFCC	5x20/2x10ml	2500
DIA-GRE-05	ALP - IFCC	4x100/4x20	6250
DIA-GRE-06	Ammonia	6x10/1x6/2x8ml	8750
DIA-GRE-07	Amylase Direct	9x10ml	7500
DIA-GRE-08	Alpha HBDH	7x10/2x7ml	3125
DIA-GRE-09	Bilirubin Direct - DC	5x20/2x10ml	2813
DIA-GRE-10	Bilirubin Direct - DC	4x100/4x20ml	7813
DIA-GRE-11	Bilirubin Total - DC	5x20/2x10ml	2813
DIA-GRE-12	Bilirubin Total - DC	4x100/4x20ml	7813
DIA-GRE-13	Bilirubin T&D - Jendrassik	1x55/1x12/4x50ml	2688
DIA-GRE-14	Bicarbonate (CO2)	5x20ml + Std	12188
DIA-GRE-15	Bicarbonate (CO2)	5x70ml + std	34375
DIA-GRE-16	Calcium Arsenazo	9x10ml	2250
DIA-GRE-17	Chloride	9x10ml	2250
DIA-GRE-18	Cholesterol	2x50ml	1563
DIA-GRE-19	Cholesterol	4x100ml	4625
DIA-GRE-20	Cholesterol	2x500ml	9375
DIA-GRE-21	CK-MB	7x10/2x7ml	10000
DIA-GRE-22	CK-MB	5x20/2x10	13125
DIA-GRE-23	CK-NAC	7x10/2x7ml	6125
DIA-GRE-24	CK-NAC	5x20/2x10	8563
DIA-GRE-25	Creatinine - Jaffe	5x50/1x50ml	2500
DIA-GRE-26	Creatinine - PAP (Enzymatic)	4x50/2x50ml	16875
DIA-GRE-27	CRP - Immunoturbi with standard	7x10/2x7ml	13125
DIA-GRE-28	CRP - Immunoturbi without standard	7x10/2x7ml	9375
DIA-GRE-29	CRP - Immunoturbi with standard	5x20/1x20ml + 1ml std	15000
DIA-GRE-30	CRP - Immunoturbi without standard	5x20/1x20ml	11250
DIA-GRE-31	CRP Calibrator	2x1ml	7500
DIA-GRE-32	Copper	9x10ml	8750
DIA-GRE-33	GGT IFCC	7x10/2x7ml	3000
DIA-GRE-34	GOT IFCC	5x20/2x10ml	2625
DIA-GRE-35	GOT IFCC	4x100/4x20	7188
DIA-GRE-36	GPT IFCC	5x20/2x10ml	2625
DIA-GRE-37	GPT IFCC	4x100/4x20ml	7188
DIA-GRE-38	HDL C Direct with standard	4x25/2x17ml + 1ml std	18125
DIA-GRE-39	HDL C Direct without standard	4x25/2x17ml	14375
DIA-GRE-40	HDL/LDL Calibrator	3x1ml	11250
DIA-GRE-41	Iron Ferrene S	5x20/2x10	2813
DIA-GRE-42	Iron - Nitro PAPS	9x10ml	4125

Product ID	Description	Pack size	Price INR
DIA-GRE-43	TIBC	2x100ml	5625
DIA-GRE-44	Lactate	9x10ml	7813
DIA-GRE-45	LDH - L IFCC	7x10/2x7ml	2844
DIA-GRE-46	Lipase - C	3x10/2x9ml	8750
DIA-GRE-47	Magnesium	9x10ml+std	2500
DIA-GRE-48	Microalbumin with standard	5x25/2x10ml + 1ml std	24063
DIA-GRE-49	Microalbumin without standard	5x25/2x10ml	20000
DIA-GRE-50	Microalbumin Standard	1x1ml	4063
DIA-GRE-51	Phosphorus UV	9x10ml+std	2063
DIA-GRE-52	Pyruvate	2x50/1x5/1x5ml	8750
DIA-GRE-53	RF with standard	5x20/1x20ml + 1ml std	32500
DIA-GRE-54	RF without standard	5x20/1x20ml	28125
DIA-GRE-55	RF standard	1x1ml	4375
DIA-GRE-56	Triglycerides	2x50ml	2938
DIA-GRE-57	Triglycerides	4x100ml	9063
DIA-GRE-58	Triglycerides	2x500ml	18750
DIA-GRE-59	Unical M	6x3ml	9375
DIA-GRE-60	Unitrol I	10x5ml	15000
DIA-GRE-61	Unitrol II	10x5ml	15625
DIA-GRE-62	Urea Liquidcolor	1x100/1x1.2/1x100ml+std	2063
DIA-GRE-63	Urea Liquidcolor	2x100/1x2.2/2x100ml+std	3875
DIA-GRE-64	Urea UV GLDH	2x50/1x20ml	2313
DIA-GRE-65	Urea UV GLDH	4x100/4x20ml	6875
DIA-GRE-66	Urea UV GLDH (Lyo)	2x50ml	2250
DIA-GRE-67	Uric Acid	4x25ml	2188
LW Series (System packs for Landwind Autoanalysers)-DIATEK-Greiner			
DIA-GRE-68	ALP - IFCC	LW 5x20/2x10ml	2500
DIA-GRE-69	Amylase Direct	LW 9x10ml	7500
DIA-GRE-70	Bilirubin Direct - DC	LW 5x20/2x10ml	2813
DIA-GRE-71	Bilirubin Total - DC	LW 5x20/2x10ml	2813
DIA-GRE-72	Calcium Arsenazo	LW 9x10ml	2250
DIA-GRE-73	Cholesterol	LW 2x50ml	1563
DIA-GRE-74	Cholesterol	LW 9x20ml	3125
DIA-GRE-75	CK-MB	LW 7x10/2x7ml	10000
DIA-GRE-76	CK-NAC	LW 7x10/2x7ml	6125
DIA-GRE-77	Creatinine Jaffe	LW 5x20/1x20ml	1250
DIA-GRE-78	GGT IFCC	LW 7x10/2x7ml	3000
DIA-GRE-79	GOT IFCC	LW 5x20/2x10ml	2625
DIA-GRE-80	GPT IFCC	LW 5x20/2x10ml	2625
DIA-GRE-81	Lipase - F	LW 7x10/2x9ml	15625
DIA-GRE-82	Lipase - C	LW 3x10/2x9ml	8750
DIA-GRE-83	LDH - L IFCC	LW 7x10/2x7ml	2844
DIA-GRE-84	Triglycerides	LW 2x50ml	2938
DIA-GRE-85	Triglycerides	LW 9x20ml	6250
DIA-GRE-86	Urea UV GLDH	LW 5x20/2x10ml	2625
DIA-GRE-87	Uric Acid	LW 5x20ml	2188

Product ID	Description	Pack size	Price INR
HIT Series (System packs for Hitachi System)- DIATEK-Greiner			
DIA-GRE-88	ALP - IFCC	HIT 4x50/2x20ml	4375
DIA-GRE-89	Bilirubin Direct - DC	HIT 4x50/2x20ml	5000
DIA-GRE-90	Bilirubin Total - DC	HIT 4x50/2x20ml	5000
DIA-GRE-91	Cholesterol	HIT 4x50ml	2938
DIA-GRE-92	GOT IFCC	HIT 4x50/2x20ml	4375
DIA-GRE-93	GPT IFCC	HIT 4x50/2x20ml	4375
DIA-GRE-94	Triglycerides	HIT 4x50	5625
DIA-GRE-95	Urea UV GLDH	HIT 4x50/2x20ml	4688
DIA-GRE-96	Uric Acid	HIT 4x50ml	3750
Immunoturbidimetric Range -Diatek-BIOLATEX			
DIA-BLT-01	ASO Immunoturbidimetric Kit	45+5ml	6250
DIA-BLT-02	CRP Immunoturbidimetric Kit	45+5ml	6250
DIA-BLT-03	RF Immunoturbidimetric Kit	45+5ml	5625
DIA-BLT-04	hsCRP	30+5.1ml	10000
DIA-BLT-05	Microalbumin (MAU)	45+5ml	6250
DIA-BLT-06	Lp(a) Immunoturbidimetric Kit	30+4.1ml	10000
DIA-BLT-07	Ferritin Immunoturbidimetric Kit	25+7.5ml	8750
DIA-BLT-08	IgE Immunoturbidimetric Kit	25+7.5ml	11250
DIA-BLT-09	IgE Immunoturbidimetric Kit	50+15ml	20000
DIA-BLT-10	Cystatin C (with 6 level multicalibrators)	30+5.1ml	31875
Coagulation Range-Diatek-Diagon			
DIA-DGN-01	Dia PT Liquid (Thromboplastin)	12x2ml	4375
DIA-DGN-02	Dia PTT Liquid (APTT)	12x2ml	5250
DIA-DGN-03	Dia - CaCl ₂	4ml	156
DIA-DGN-04	Dia Fibrinogen with Imidazole Buffer	12x2ml	12500
DIA-DGN-05	Dia TT (Thrombin Time)	12x3ml	5625
DIA-DGN-06	Dia Cont I+II	2(10x1ml)	10000
DIA-DGN-07	Dia Calibrator	12x1ml	6250
Diatek INDIGENOUS RANGE			
Biochemistry			
DIA-IND-01	Albumin + Total Protein	2x50ml	625
DIA-IND-02	Bilirubin T&D	2x100ml	625
DIA-IND-03	Creatinine SL	2x50 ml	875
DIA-IND-04	Cholesterol	4x25ml	1375
DIA-IND-05	Cholesterol	6x100ml	6000
DIA-IND-06	Calcium Arsenazo Monovials	50T	750
DIA-IND-07	Cholinesterase	2x20/1x8ml (48ml)	5625
DIA-IND-08	Glyco Hemoglobin	10T	1250
DIA-IND-09	Glyco Hemoglobin	30T	3375
DIA-IND-10	GPT DB	4x50ml	1875
DIA-IND-11	GOT DB	4x50ml	1875
DIA-IND-12	Hemoglobin	1000ml	375
DIA-IND-13	Hemoglobin	2500ml	750

Product ID	Description	Pack size	Price INR
DIA-IND-14	HDL Chol precipitating Reagent	10ml	250
DIA-IND-15	HDL Chol precipitating Reagent	25ml	500
DIA-IND-16	Homocysteine with 1 cal	28ml	31250
DIA-IND-17	Liqui Glucose	2x500ml	1750
DIA-IND-18	Liqui Glucose	5x100ml	938
DIA-IND-19	Microprotein	2x30ml	625
DIA-IND-20	Potassium	20T	813
DIA-IND-21	Sodium+Potassium	2x20T	1813
DIA-IND-22	Sodium+Potassium+Chloride	3x15T	1813
DIA-IND-23	Urea Berthelot	2x60ml	1000
DIA-IND-24	Urea Berthelot	2x110ml	1563
DIA-IND-25	Urea Berthelot	6x100ml	3375
Serology			
DIA-IND-26	Diatek ASO	25T	1238
DIA-IND-27	Diatek ASO	100T	2688
DIA-IND-28	Diatek CRP	25T	906
DIA-IND-29	Diatek CRP	100T	2494
DIA-IND-30	Diatek RF	25T	500
DIA-IND-31	Diatek RF	100T	1563
DIA-IND-32	Diatek RPR	50T	438
DIA-IND-33	Widal -Slide	4x5ml	475
DIA-IND-34	Widal -S- O&H	2x2x5ml	556
Diatek-INBIOS International, USA Products			
DIA-INB-01	DENV Detect IgM Capture ELISA	96 Wells (48T)	11875
DIA-INB-02	DENV Detect IgM Capture ELISA	96T	18750
DIA-INB-03	DENV Detect NS1 ELISA	96T	20625
DIA-INB-04	JE Detect IgG ELISA	96T	21250
DIA-INB-05	JE Detect IgM ELISA	96T	21250
DIA-INB-06	Scrub Typhus IgG ELISA	96T	20000
DIA-INB-07	Scrub Typhus IgM ELISA	96T	20000
DIA-INB-08	West Nile IgG ELISA	96T	25000
DIA-INB-09	West Nile IgM ELISA	96T	25000
DIA-INB-10	Filaria IgG4 ELISA	96T	18750
DIA-INB-11	Kalazar Detect Rapid Strips	10T	3125
DIA-INB-12	Kalazar Detect Rapid Strips	25T	7813
DIA-INB-13	Dengue NS1 Detect Rapid Strips	25T	9375
Diatek-DIAGNOSTIC AUTOMATION, USA Range			
DIA-DAU-01	T3	96T	6250
DIA-DAU-02	T4	96T	6250
DIA-DAU-03	TSH	96T	6875
DIA-DAU-04	FT3	96T	8750
DIA-DAU-05	FT4	96T	8750
DIA-DAU-06	LH	96T	7500
DIA-DAU-07	FSH	96T	7500
DIA-DAU-08	Prolactin	96T	7500

Product ID	Description	Pack size	Price INR
DIA-DAU-09	B HCG	96T	7500
DIA-DAU-10	Estradiol	96T	14375
DIA-DAU-11	Estriol	96T	23750
DIA-DAU-12	Progesterone	96T	14375
DIA-DAU-13	Testosterone	96T	14375
DIA-DAU-14	Free Testosterone	96T	23750
DIA-DAU-15	Cortisol	96T	18750
DIA-DAU-16	DHEA-S	96T	23750
DIA-DAU-17	Ferritin	96T	9375
DIA-DAU-18	PSA	96T	9375
DIA-DAU-19	CEA	96T	9375
DIA-DAU-20	AFP	96T	9375
DIA-DAU-21	Free PSA	96T	11250
DIA-DAU-22	CA12.5	96T	15625
DIA-DAU-23	CA15.3	96T	15625
DIA-DAU-24	CA19.9	96T	15625
DIA-DAU-25	H.Pylori Antigen Rapid Card	25T	15625
DIA-DAU-26	Vitamin B12	96T	25000
DIA-DAU-27	Insulin	96T	19375
Diatek-Nal Von Minden, Germany TORCH ELISA Range			
DIA-NVM-01	Toxo IgG	96T	8750
DIA-NVM-02	Toxo IgM	96T	9375
DIA-NVM-03	Rub IgG	96T	8750
DIA-NVM-04	Rub IgM	96T	9375
DIA-NVM-05	CMV IgG	96T	8750
DIA-NVM-06	CMV IgM	96T	9375
DIA-NVM-07	HSV 1 IgG	96T	8750
DIA-NVM-08	HSV 1 IgM	96T	9375
DIA-NVM-09	HSV 2 IgG	96T	8750
DIA-NVM-10	HSV 2 IgM	96T	9375
DIA-NVM-11	HSV 1+2 IgG	96T	8750
DIA-NVM-12	HSV 1+2 IgM	96T	9375
DIATEK RAPID Range			
DIA-IND-35	HCG Strip Slim	100T	1000
DIA-IND-36	HCG Card (3mm)	50T	1500
DIA-IND-37	Syphilis Strip	100T	3125
DIA-IND-38	Syphilis Card	50T	1875
DIA-IND-39	HIV 3 Line	50T	4375
DIA-IND-40	HBsAg Card	50T	1563
DIA-IND-41	HCV Card	50T	5625
DIA-IND-42	Urine strip 2GP	100T	469
DIA-IND-43	Urine strip 10 Parameter	100T	1250
DIA-IND-44	Troponin I Card	1T	563
DIA-IND-45	Malaria pf/pv antibody Card	50T	3750
Micropipettes			
DIATEK Fixed Volume			

Product ID	Description	Pack size	Price INR
DIA-IND-46	(5ul, 10ul, 20ul, 50ul, 100ul, 200ul, 250ul, 500ul, 1000ul)	each	2500
DIATEK Variable Volume			
DIA-IND-47	2-20ul	1 no.	4750
DIA-IND-48	5-50ul	2 no.	4750
DIA-IND-49	10-100ul	3 no.	4750
DIA-IND-50	20-200ul	4 no.	4750
DIA-IND-51	100-1000ul	5 no.	4750
Diatek Healthcare Range			
DIA-HLT-01	ADA - MTB	30ML	7250
DIA-HLT-02	ADA WITH CALIBRATOR	2x20/1x20ML	10625
DIA-HLT-03	ALBUMIN	2x50ML	625
DIA-HLT-04	ALBUMIN	5x100ML	2500
DIA-HLT-05	ALKALINE PHOSPHATASE AMP (IFCC)	5x10ML	1250
DIA-HLT-06	Amylase CNPG3	2x10ML	1875
DIA-HLT-07	CHOLESTEROL	2x25ML	938
DIA-HLT-08	CHOLESTEROL	2x50ML	1563
DIA-HLT-09	CHOLESTEROL	5x100ML	5000
DIA-HLT-10	Calcium Arsenazo Monovials	25x1ML	500
DIA-HLT-11	Calcium Arsenazo	5x10ML	1250
DIA-HLT-12	Calcium Arsenazo	5x25ML	2500
DIA-HLT-13	CO2	2x20ML	5000
DIA-HLT-14	CRP Immuno	4x10ML	6250
DIA-HLT-15	Direct HDL Cholesterol	40ML	4063
DIA-HLT-16	Direct HDL Cholesterol	80ML	6563
DIA-HLT-17	Direct LDL Cholesterol	40ML	6250
DIA-HLT-18	Direct LDL Cholesterol	80ML	10313
DIA-HLT-19	HbA1c	40ML	31250
DIA-HLT-20	HbA1c	20ML	18750
DIA-HLT-21	HbA1c calibrator Set	4X 0.5ML	8750
DIA-HLT-22	Lipase Monotest	10T	1875
DIA-HLT-23	Lipase	2x7.5/1x9ML (24ML)	5625
DIA-HLT-24	Magnesium Monovials	25x1ML	500
DIA-HLT-25	Phosphorus Monovials	25x1ML	500
DIA-HLT-26	SGOT (AST)	5x10ML	1250
DIA-HLT-27	SGOT (AST)	5x25ML	2500
DIA-HLT-28	SGOT (AST)	5x100ML	6250
DIA-HLT-29	SGPT (ALT)	5x10ML	1250
DIA-HLT-30	SGPT (ALT)	5x25ML	2500
DIA-HLT-31	SGPT (ALT)	5x100ML	6250
DIA-HLT-32	TOTAL PROTEIN	2x50ML	625
DIA-HLT-33	TOTAL PROTEIN	5x100ML	2500
DIA-HLT-34	TRIGLYCERIDES	2x25ML	1500
DIA-HLT-35	TRIGLYCERIDES	2x50ML	2750
DIA-HLT-36	TRIGLYCERIDES	5x100ML	10625
DIA-HLT-37	UREA GLDH	4x10ML	1000

Product ID	Description	Pack size	Price INR
DIA-HLT-38	UREA GLDH	4x20ML	1875
DIATEK-PRISTINE BIOMEDICAL RANGE			
Dia-Prist-01	Glucose Kit	2x500ml	885
Dia-Prist-02	Cholesterol Kit	5x100ml	3150
Dia-Prist-03	Triglycerides Kit	5x100ml	7500
Dia-Prist-04	Total Protein Kit	5x100m	1387.5
Dia-Prist-05	GOT kit	5x100m	3600
Dia-Prist-06	GPT Kit	5x100ml	3600
Dia-Prist-07	Urea GLDH Kit	4x40ml	1425
Dia-Prist-08	Amylase Kit	2x10ml	1125
Dia-Prist-09	Lipase Kit	3x10/2x9ml	7425
Dia-Prist-10	Alkaline Phosphatase	4x100/4x20ml	4395
Dia-Prist-11	HDL Cholesterol Kit	80ml	3360
Dia-Prist-12	LDL Cholesterol Kit	80ml	7200
Dia-Prist-13	Calcium Kit	5x25ml	1200

Anatomy Study models (Educational Models), designed for demonstrational purposes (for example, in education or exhibitions), unsuitable for other uses.

Part No.	MODEL Description	HSN	PRICE ₹
SB-M189	XC-101 Human Skeleton (Tall 180CM LIFE SIZE)	9023	17849
SB-M190	XC101A HUMAN SKELETON WITH MUSCLES & LIGAMENTS TALL 180CM	9023	31980
SB-M191	XC-102 HUMAN SKELETON (TALL 85CM) MEDIUM SIZE	9023	3900
SB-M192	XC-102B HUMAN SKELETON (TALL 85CM WITH NERVER & BLOOD VESSELS	9023	5850
SB-M193	XD101C HUMAN SKELETON PAINTED (TALL 170 CM LIFE SIZE	9023	24700
SB-M194	XD-104-1 DISARTICULATED SKULL	9023	5070
SB-M195	X-C130 DISARTICULATED HUMAN SKELETON WITH SKULL	9023	12467
SB-M196	XC-126 VERTEBRAL COLLUMN WITH PELVIS & FEMUR HEADS (TALL 85CM	9023	6630
SB-M197	XC103/SK046 MINI HUMAN SKELETON (TALL 42CM)/MINI SKELETON (TALL 46CM)	9023	1482
SB-M198	XD-136 VERTEBRAL COLUMN WITH SKULL (TALL 44CM)	9023	6240
SB-M199	XD-140 VERTEBRAL AND PARTIAL SPINAL CORD	9023	2925
SB-M200	XC-118 LUMBAR SET (4PCS	9023	1560
SB-M201	XC-119 LUMBAR VERTEBRAE WITH SACRUM & COCCYX LIFE SIZE	9023	4485
SB-M202	XC-133 CERVICAL VERTEBRAE WITH NECK ARTERY	9023	POR
SB-M203	XC-115 PELVIS WITH 5PCS LUMBAR VERTEBRAE	9023	4550
SB-M204	XC-125 FEMALE PELVIS WITH MUSCLES AND ORAGANS	9023	3276
SB-M205	XC-123 ADULT MALE PELVIS	9023	2249
SB-M206	XC-124 ADULT FEMALE PELVIS	9023	2249
SB-M207	XC-127 BIRTH DEMONSTRATION MODLE	9023	3276
SB-M208	XC-117 LUMBAR SET (3PCS	9023	1430

Part No.	MODEL Description	HSN	PRICE ₹
SB-M209	XD-120 FEMUR BONE	9023	2015
SB-M210	XD-128 BIG ADULT ARM BONE MODEL WITH BLOOD VESSELS	9023	4030
SB-M211	XD-129 BIG ADULT LEG BONE MODEL WITH BLOOD VESSELS	9023	4030
SB-M212	XD-133C HUMAN THORACIC SPINAL COLUMN	9023	4875
SB-M213	XC-109 SHOULDER JOINT (LIFE SIZE)	9023	1586
SB-M214	XC-110 HIP JOINT (LIFE SIZE)	9023	1586
SB-M215	XC-111 KNEE JOINT (LIFE SIZE)	9023	1586
SB-M216	XC-112 ELBOW JOINT (LIFE SIZE)	9023	1586
SB-M217	XC-113 FOOT JOINT (LIFE SIZE)	9023	1586
SB-M218	XC-114 HAND JOINT (LIFE SIZE)	9023	1586
SB-M219	XD-118 KNEE FUNCTIONAL JOINT (LIFE SIZE)	9023	2860
SB-M220	XD-127 FUNCTIONAL ELBOW JOINT (LIFE SIZE)	9023	4160
SB-M221	XC-113A FOOT JOINT WITH LIGAMENTS (LIFE SIZE)	9023	1820
SB-M222	XC-114A HAND JOINT WITH LIGMENTS (LIFE SIZE)	9023	1820
SB-M223	XC-104C COLOURED SKULL (LIFE SIZE)	9023	3315
SB-M224	GD/A11115 INFANT SKULL	9023	5057
SB-M225	XC-104 ADULT SKULL (LIFE SIZE)	9023	2379
SB-M226	XD-121 FOETAL CHILD SKULL	9023	2210
SB-M227	XC-320 LARYNX HEART AND LUNGS MODEL	9023	6942
SB-M228	XD-334 CARDIAC BEAT AND BLOOD CIRCULATION MODEL	9023	18200
SB-M229	XC-204 UNISEX TORSO (TALL 85CM) 23 PARTS	9023	17147
SB-M230	XC-203 HUMAN TORSO (TALL 26CM 15 PARTS	9023	3705
SB-M231	XC-205 UNISEX TORSO 45CM ,23 PARTS /HUMAN TORSO 50CM, 11 PARTS	9023	8060
SB-M232	XD-207 MODEL OF THE AND NECK HORIZONTAL SHEARS	9023	POR
SB-M233	XD-206 HUMAN TORSO (TALL 90CMS) HORIZONTAL SHEARS 93PCS	9023	POR
SB-M234	XD-208 HUMAN TORSO (TALL 90CMS) VERTICAL SHEARS 10PCS	9023	POR
SB-M235	XC-315 DIGESTIVE SYSTEM MODEL	9023	9516
SB-M236	XC-307 JUMBO HEART MODEL	9023	3016
SB-M237	XC-307A/PDOO2 HEART MODLE (LIFE SIZE)	9023	2145
SB-M238	XC-308 BRAIN WITH ARTERIES MODEL	9023	2171
SB-M239	XC-306 STOMACH MODEL	9023	2067
SB-M240	XC-311 LIVER PANCREAS AND DUODENUM MODELS	9023	2431
SB-M241	XC-312 LIVER MODEL	9023	3887
SB-M242	MK-019 PUMPING HEART MODEL	9023	1820
SB-M243	GD/A42004 EMBRYO MODEL	9023	3510
SB-M244	XD-311-1 MODEL OF SPLEEN PANCREAS AND DUODENUM	9023	1950
SB-M245	XD-336 DNA STRUCTURE SIMULATION KIT MODEL	9023	3055
SB-M246	XD-335 DNA ACTIVITY MODEL	9023	3965
SB-M247	XD-143 MODEL OF DNA STRUCTURE (TALL 70CM	9023	POR
SB-M248	XD-145 PROTEIN STRUCTURE MODEL (TALL 70CM	9023	POR

Part No.	MODEL Description	HSN	PRICE ₹
SB-M249	XC-330 TRANSPARENT LUNGS SEGMENT MODEL	9023	6227
SB-M250	XC-301 MAGNIFIED HUMAN LARYNX MODEL	9023	1456
SB-M251	XC-302 MAGNIFIED PULMONARY ALVEOLI MODEL	9023	2080
SB-M252	xc-310-3 KIDNEY WITH ADRENAL GLAND MODEL	9023	1872
SB-M253	XC-310-1 KIDNEY MODEL (1PART)	9023	2795
SB-M254	XC-310-2 KIDNEY MODEL (2PART)	9023	3107
SB-M255	XD-131 FUNCTIONAL EYE MODEL	9023	5655
SB-M256	XC-313 SKIN MODEL ENLARGED	9023	2444
SB-M257	XC-313-2 SKIN BLOCK MODEL ENLARGED	9023	3900
SB-M258	XC-316B EYE WITH ORBIT MODEL	9023	5369
SB-M259	XC316 GIANT EYE MODEL	9023	2340
SB-M260	XC-330C EAR MODEL (GIANT SIZE)	9023	2574
SB-M261	XC-403/TH001 TOOTH HYGIENE SET MODEL/DENTAL CARE MODEL WITH BRUSH	9023	3003
SB-M262	XC-305 EXPANSION MODEL HUMAN TEETH	9023	2860
SB-M263	XD-305-4 TEETH MODEL WITH DESCRIPTION PLATE	9023	3575
SB-M264	XD-3051 HUMAN TEETH	9023	2990
SB-M265	XD305-2 HALF LOWER JAW	9023	3835
SB-M266	XC-324 MODEL OF THE HEAD	9023	4901
SB-M267	XC-318 BRAIN WITH ARTERIES ON HEAD MODEL	9023	4524
SB-M268	XD-196 MODEL OF CRANIAL CAVITY HEAD NECK AND THORAX	9023	8645
SB-M269	XD-200 MEDIAN SECTION OF THE HEAD	9023	3250
SB-M270	XC-317 EXPANSION MODEL OF URINARY BLADDER	9023	1547
SB-M271	XC-309 MODEL OF THE ANATOMICAL NASAL CAVITY	9023	1521
SB-M272	TH-002 DENTAL MODEL SMALL	9023	1430
SB-M273	VT-021 FROG DISSECTION KIT	9023	4355
SB-M274	GD/L64 PERITONEAL DIALYSIS SIMULATOR	9023	92495
SB-M275	GD/L63 PROSTATE INSPECTION MODEL	9023	94887
SB-M276	SK-007 EAR ANATOMY MODEL (SMALL SIZE 14CM.)	9023	POR
SB-M277	SK-008 HUMAN BODY ANATOMY MODEL (SMALL SIZE 12.7CM)	9023	POR
SB-M278	SK-009 HEART ANATOMY MODEL (SMALL SIZE 14CM)	9023	POR
SB-M279	SK-010 CRANIAL NERVE SKULL ANATOMY MODEL (SMALL SIZE9CM.)	9023	POR
SB-M280	XD-109 MODEL OF TRANSPARENT HUMAN (TALL 85CM)	9023	10205
SB-M281	GD/A1130A/1 MALE MUSCLE FIGURE MODEL (TALL 78CM)	9023	39650
SB-M282	XC-407 HUMAN TRACHEA INTUBATION MODEL	9023	34450
SB-M283	XD-333-1 FUNCTIONAL HUMAN RESPIRATORY MODEL	9023	18200
SB-M284	XD-330-1 LUNG DEMONSTRATION MODEL	9023	3107
SB-M285	XD-199 NEURON MODEL	9023	5005
SB-M286	GD/A15102 MALE GENITAL ORGANS MODEL	9023	11310
SB-M287	GD/A15105 FEMALE GENITAL ORGANS MODEL	9023	9360
SB-M288	GD/-151 HUMAN PLACENTA ANATOMISE MODEL	9023	3835

Part No.	MODEL Description	HSN	PRICE ₹
SB-M289	GD/A12006 APPENDIX AND CAECUM MODEL	9023	4186
SB-M290	XC-436A MAGNIFIED UTERUS MODEL	9023	1235
SB-M291	XC-429 FEMALE INTERNAL & EXTERNAL GENITAL ORGANS	9023	1677
SB-M292	GD/A18001 NEURON MODEL	9023	9659
SB-M293	GD/F55 ADVANCE DELIVERY & MATERNAL & NEONATAL EMERGENCY SIMULATOR	9023	357500
SB-M294	GD/H220B ADVANCED ELDERLY FULLY-FUNCTION NURSING MANIKIN FEMALE	9023	121550
SB-M295	GD/J50 AIRWAY INTUBATION SIMULATOR	9023	60450
SB-M296	GD/J55 MULTI FUNCTIONAL AIRWAY MANAGEMENT MODEL	9023	90025
SB-M297	GD/F5N IUD TRAINING MODEL	9023	5915
SB-M298	GD/A42010/1 HUMAN PLACENTA MODEL	9023	3510
SB-M299	GD/H120A ADVANCED NURSING & WOUND CARE MANIKIN (MALE)	9023	94887
SB-M300	XC-401A HIGH QUALITY NURSE TRAINING DOLL (MALE UNISEX)	9023	55770
SB-M301	XC-401B HIGH QUALITY NURSE TRAINING DOLL (FEMALE UNISEX)	9023	55770
SB-M302	XC-401 MULTIFUNCTIONAL PATIENT CARE NURSING MANIKIN	9023	19435
SB-M303	XC-408 ELECTRONIC URINARY MODEL	9023	34450
SB-M304	GD/H100S BASIC COMBINATION NURSING MANIKIN	9023	71695
SB-M305	GD/H2 MULTI-FUNCTIONAL NURSING MANIKIN	9023	27885
SB-M306	GD/FT333 ADVANCED MULTI-FUNCTIONAL CHILD NURSING MANIKIN (UNISEX)	9023	92495
SB-M307	GD/A42007 DEMONSTRATION MODEL OF CHILDBIRTH	9023	33930
SB-M308	GD/H130 ADVANCED NURSING BABY (UNISEX)	9023	46605
SB-M309	GD/F30S GYNECOLOGICAL EXAMINATION MODEL	9023	73645
SB-M310	XC-332B HUMAN FEMALE PREGANT PELVIS SECTION WITH FETUS	9023	8034
SB-M311	XC-331A HUMAN MALE PELVIS SECTION (1PART)	9023	2873
SB-M312	XC-332A HUMAN FEMALE PELVIS SECTION (1PART)	9023	2873
SB-M313	XC-331B HUMAN MALE PELVIS SECTION (2PART)	9023	6786
SB-M314	XC-331C ADVANCED MALE INTERNAL AND EXTERNAL ORGANS	9023	3120
SB-M315	XC-332C ADVANCE FEMALE INTERNAL AND EXTERNAL ORGANS	9023	3120
SB-M316	XC-331 MALE UROGENITAL SYSTEM	9023	2171
SB-M317	XC-332 FEMALE UROGENITAL SYSTEM	9023	2171
SB-M318	XC-408C MALE CATHETERIZATION TRAINING SIMULATOR	9023	21970
SB-M319	XC-408D FEMALE CATHETERIZATION TRAINING SIMULATOR	9023	21970
SB-M320	MK064 VISIBLE EXPECTANT MOTHER ANATOMY MODEL	9023	8320
SB-M321	GD/F20G LABOUR DELIVERY MODEL	9023	33735
SB-M322	XC-405 NURSE BASIC PRACTICE TEACHING MODEL	9023	33150
SB-M323	GD/A42008 FETUS WITH VISCUS PLACENTA	9023	19305
SB-M324	GD/A41003 OVARY MODEL	9023	19435
SB-M325	XC-409 NEWBORN BABY MODEL	9023	2665
SB-M326	XC-409A NEWBORN BABY MODELS (NEW STYLE) MALE	9023	3497

Part No.	MODEL Description	HSN	PRICE ₹
SB-M327	XC-402/GDF6 MODEL FOR COURSE OF DELIVERY /LEOPOLD MANEUVERS SIMULATOR	9023	30550
SB-M328	XC-410 NEWBORN INTUBATION BABY FETUS MODEL	9023	7085
SB-M329	XC-414 DEVELOPMENT PROCESS FOR FETUS MODEL	9023	37050
SB-M330	GD/F8 MIDWIFERY TRAINING SIMULATOR	9023	29835
SB-M331	GD/F52 ADVANCED DELIVERY MECHANISM DEMONSTRATION SIMULATOR	9023	83070
SB-M332	GD/A42001 FERTILIZATION PROCESS SIMULATOR	9023	13650
SB-M333	GD/A12002 HUMAN FERTILIZATION AND EARLY EMBRYOLLOGY MODEL	9023	44850
SB-M334	GD/F54 ADVANCED ABDOMINAL PALPATION AND DELIVERY MECHANISM Integrated simulator	9023	129987
SB-M335	COMMUNITY HEALTH BAG WITH ACCESSORIES	9023	4420
SB-M336	GD-F20 CHILDBIRTH SKILL TRAINING SIMULATOR	9023	193700
SB-M337	GD/F35 ADVANCED GYNECOLOGICAL TRAINING SIMULATOR	9023	165100
SB-M338	GD/ACLS145 ACLS NEONATAL TRAINING MANIKIN	9023	POR
SB-M339	GD/HS10B ADVANCED BUTTOCK INTRAMUSSULAR INJECTION SIMULATOR	9023	POR
SB-M340	GD/F9E IUD TRAINING SIMULATOR	9023	3705
SB-M341	GD/F9F IUD TRAINING SIMULATOR	9023	1989
SB-M342	GD/L69D ADVANCED NEONATAL PERIPHERAL AND CENTRAL VEIN INTUBATION SIMULATOR	9023	72670
SB-M343	GD/J140 BABY OBSTRUCTION MODEL	9023	19240
SB-M344	GD/J15 NEONATE INTUBATION TRAINING MODEL	9023	23530
SB-M345	GD/L69BCENTRAL VENOUS CHTHETERIZATION SIMULATOR	9023	96070
SB-M346	GD/CPR1028 ADVANCED ADULT CPR TRAINING MANIKIN WITH MONITOR &PRINTER	9023	141700
SB-M347	GD/F7A BREAST EXAMINATION MODEL	9023	30160
SB-M348	GD/FW2 MATERNITY EXAMINATION MODEL	9023	101270
SB-M349	GD/CPR10160 ADVANCED CHILD CPR TRAINING MANIKIN	9023	110370
SB-M350	GD/CPR10150 ADVANCED INFANT CPR TRAINING MANIKIN	9023	93860
SB-M351	GD/CPR10170 HALF-BODY CPR TRAINING MANIKIN	9023	66625
SB-M352	XD504 MODEL FOR CENTRAL VENUS PUNCTUREAND TRUNCUS INJECTION SIMULATOR	9023	POR
SB-M353	XD-333D HUMAN LYMPH NODE	9023	2405
SB-M354	XC-406 WHOLE BODY BASIC CPR MANIKIN (MALE) WITH MONITOR AND PRINTER	9023	102245
SB-M355	XC-406A WHOLE BODY BASIC CPR MANIKIN (FEMALE) WITH MONITOR AND PRINTER	9023	102245
SB-M356	XC-404A HALF BODY CPR TRAINING MODEL (MALE)	9023	40950
SB-M357	XC-404B HALF BODY CPR TRAINING MODEL (FEMALE)	9023	40950
SB-M358	XC-404 BASIC CPR MANIKIN (HALF BODY) WITH MONITOR	9023	42250
SB-M359	XC-434 INJECTABLE TRAINING ARM MODEL	9023	7345
SB-M360	XC-431 BUTTOCK INJECTION MODEL	9023	2632.5

Part No.	MODEL Description	HSN	PRICE ₹
SB-M361	GD/LVI ADVANCED SURGICAL SUTURING ARM MODEL	9023	24635
SB-M362	GD/HS2 MULTI-FUNCTIONAL ADULT IV TRAINING ARM MODEL	9023	32370
SB-M363	GD/LV2 ADVANCED SURGICAL SUTURE LEG	9023	32435
SB-M364	GD/F3B VULVA SUTURING TRAINING SIMULATOR	9023	11167
SB-M365	GD/HS6E NEONATE SCALP VENIPUNCTURE MODEL	9023	35035
SB-M366	XC-417 CONTRACEPTION GUIDANCE MODEL	9023	3315
SB-M367	XC-442 IV INJECTION PAID	9023	3185
SB-M368	XC-441A ELECTRONIC IV TRAINING HAND	9023	29250
SB-M369	XC-442A SUTURE PRACTICE PAD	9023	3575
SB-M370	GD/A15102A GENITAL EXTENDER MODEL MALE HOLLOW STRAP-ON	9023	7500
SB-M371	XC-431A ELECTRONIC BUTTOCKS IN INJECTION SIMULATOR	9023	29250
SB-M372	GD/HS7 ADVANCED BLOOD PRESSURE TRAINING ARM MODEL	9023	38870
SB-M373	GD/HSR MULTI FUNCTIONAL CHILD IV TRAINING ARM MODEL	9023	26650
SB-M374	GD/J110 ADVANCED TRAUMA NURSING CARE MANIKIN	9023	148850
SB-M375	GD/J5S ELECTRIC TRACHEAINTUBATION MODEL	9023	51350
SB-M376	GD/LV18 SURGICAL SUTURING AND BANDAGING SIMULATOR	9023	83525
SB-M377	GD/L69C PICC LINE (PERIPHERALLY INSERTED CENTRAL CATHETER)	9023	94250
SB-M378	XD-132 FOOT SET	9023	4550
SB-M379	XD-350 HUMAN MUSCULAR BODY MODEL	9023	10855
SB-M380	GD/HS39 FULL -FUNCTIONAL VEIN INJECTION ARM	9023	64350
SB-M381	GD/F9B ADVANCED FEMALE CONTRACEPTION PRACTICE MODEL	9023	8710
SB-M382	GD/F5M MALE CONDOM TRAINING MODEL	9023	4745
SB-M383	GD/A18101 NERVOUR SYETEM MODEL	9023	16250
SB-M384	GD/A18110 SYMPATHETIC NERVOUS SYSTEM MODEL	9023	25350
SB-M385	GD/A 16001 CIRCULATORY SYSTEM MODEL	9023	13325
SB-M386	GD/A18102 SPINAL CORD IN THE SPINAL CANAL MODEL	9023	20150
SB-M387	GD/A 12001 DIGESTIVE SYSTEM	9023	14235
SB-M388	GD/A16011 LYMPHATIC SYSTEM MODEL	9023	26650

MATHEMATICAL MODEL & KITS			
Part No.	Name of the Model	HSN	Price
MATHEMATICAL MODEL & KITS (JUNIOR)			
SB-M501	S4 JO1.Set of 12 Geometrical figures size 5X10 cms	9023	360
SB-M502	S4 JO2. Geometrical Instruments box. Plastic superior	9023	450
	S4JO3. Measuring Instruments		
SB-M504	A. Tape for learning measurment 3. meter	9023	72
SB-M505	B. Jug & beaker 50 ml to 1000ml Set of5	9023	144
SB-M506	C.Wall Thermometer on plastic bass	9023	156
SB-M507	D.Chemical Thermometrr 30.cm	9023	48
SB-M508	E. Kitchen Balance	9023	540
SB-M509	S4JO 4. Geo board made of transparent plastic can be used onohp with rubber balance	9023	180

Part No.	Name of the Model	HSN	Price
SB-M510	S4JO5. Abacus wooden 30Cm	9023	336
SB-M511	S4JO6.Fibre Dummy clock for teaching reading of time on a clock	9023	150
SB-M512	S4JO7. Skip Counting game with marbles price per set	9023	240
SB-M513	S4JO8.Count your own designer fraction made of rubber foam set of triangle in 3 colour each	9023	240
SB-M514	S4JO9. Pattern making with plastic triangles 3 different size	9023	336
SB-M515	S4JO10. Game of place value	9023	336
SB-M516	S4JO11. Charts for Arithmetics size 50X 75Cm	9023	650
SB-M517	S4 O1. English Numerical	9023	72
SB-M518	S4O2. Addition	9023	72
SB-M519	S4O3 Subtraction	9023	72
SB-M520	S4O4. Multiplication	9023	72
SB-M521	S4O5. Division	9023	72
SB-M522	S4O6.Multiplication Table	9023	72
SB-M523	S4O7. Roman Numerical Chart	9023	72
SB-M524	S412.Magnet fraction Disc with magnetic board	9023	348
SB-M525	S413.Transparencies set of 10 price per set	9023	720
SB-M526	S414.PVC charts for practicing size 67X100cm numerical, multiplication table & graph 2cm set of 3	9023	307
SB-M527	S415.Half meter scale wooden	9023	24
SB-M528	S4J16. Set of pearl marbles -400 pcs. price per set	9023	540
SB-M529	S4J17.Plastic moulds: geometrical shapes set of 12 with pkts. Of clay price per set	9023	180
SB-M530	S4J18. Set of cups price per set	9023	90
SB-M531	S4J19. Junior pythagorus theorem, made of acrylic	9023	192
SB-M532	S4J20.Geometrical stencils:10 shapes of plane figures size 18X22cm price per set	9023	480
SB-M533	MKJ-1ALL THE ABOVE ITEMS, PACKED IN A KIT	9023	7200
MATHEMATICAL MODELS & KITS (SENIOR)			
SB-M538	S4S01. Geoboard made of transparent plastic can be used onophwith rubberhand	9023	180
SB-M539	S4S02. Magnet fraction disc with magnetic. Board made of rubberfoam to teach circle and its parts with screen printing	9023	348
SB-M540	S4S03. Pear marbles set of 400 Price per set	9023	540
SB-M541	S4S04.Pythagorus theorem formula derivation practical game a^2+b^2 each	9023	600
SB-M542	S4S05. Banking dummy cheque book & dummy pay in slip Price per set	9023	144
SB-M543	S4S06 Charts printed on polyart set of 5 each size 70x100cm	9023	2000
SB-M544	A Mensuration chart	9023	780
SB-M545	B Graph chart laminated	9023	420
SB-M546	C. Shapes & figures (Description of figures with their angles & construction)	9023	420
SB-M547	D.Chart of math symbol	9023	420
SB-M548	E. Algebra identities Price per set	9023	1080
SB-M549	S4S07. Derivation of the value of pi size 28 cm	9023	168
SB-M550	S4S08. Set of cups with volumetric scale printed	9023	102
SB-M551	S4S09 Cubes of algebra size 2cm.set of 128 cubes Price per set	9023	600

Part No.	Name of the Model	HSN	Price
	S4S10. Mensuration kit: for understanding the following	9023	
SB-M553	A. Area of parallelogram	9023	780
SB-M554	B. Area of triangle set of 3	9023	420
SB-M555	C. Area of rhombus	9023	420
SB-M556	D. Area of Trapezium	9023	420
SB-M557	E. Mid point Theorem	9023	420
SB-M558	F. Area of a circle	9023	420
SB-M559	G. Properties of parallelogram	9023	420
SB-M560	H. Quadrilateral formed by the mid points of a quadrilateral	9023	420
SB-M561	I. Algebraic identity set of cubes Price per set	9023	2400
SB-M562	S4S0 11. Charts on mathematics for upper primary set of 15 Price per set	9023	1080
SB-M563	S4S012. Sextant model	9023	540
SB-M564	S4S013. Theodolite model	9023	660
SB-M565	S4S014. Optical square brass	9023	336
SB-M566	S4S015. Cross vertical staff brass	9023	450
SB-M567	S4S016. Vernier caliper	9023	390
SB-M568	S4S017. Model standard time indicator	9023	390
SB-M569	S4S018. Metal wired tape meter	9023	240
SB-M570	S4S019. Rain gauge brass	9023	960
SB-M571	S4S20. Angle in a circle & its part	9023	114



Patho Gene-spin™ DNA/RNA Extraction Kit



A product which extracts DNA/RNA easily and quickly from various pathogenic samples infected by virus or bacteria such as plasma, blood, serum, cell-free body fluids, cell, and tissue etc.

- Used low concentration of chaotropic salt and better lysis efficiency
- Higher efficiency of lysis without additional additives
- Stable extraction of DNA/RNA from various pathogenic samples
- Be used safely with non-phenol method and no need for EtOH precipitation
- Suitable for sample extraction such as forensic medicine and diagnosis of diseases etc.

The Patho Gene-spin™ DNA/RNA Extraction Kit uses a low concentration of chaotropic salt and has a better lysis efficiency unlike conventional Total RNA Extraction products. Total DNA/RNA can be extracted from various pathogen samples like virus and bacteria, even anticoagulated plasma/blood, serum, cell-free body fluids and pathogenic cell/tissue etc. And it is easy to induce lysis without any additive like mercaptoethanol. In addition, DNA/RNA extraction is faster and more efficient by using columns that silica-gel membrane technology applied. The DNA/RNA isolated by the Patho Gene-spin™ Kit can be used for clinical diagnosis of people and animals infected with diseases caused by viruses and bacteria.

Agrisera is a Swedish company specializing in polyclonal and monoclonal antibody production, offering an extensive collection of primary antibodies and over 2000 secondary antibodies for various applications



**Primary antibodies
Plant/Algal**

Agrisera offers an extensive list of antibodies, suitable for detection of plant and algal proteins in a wide range of research areas and applications. Agrisera antibodies are reactive in thousands of plants and algal species, and cited in thousands of scientific articles.

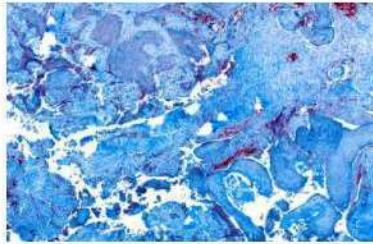

**Primary antibodies
Human/Animal**

Agrisera has a large collection of antibodies suitable for detection of human proteins, many related to amyloid disorders. A variety of antibodies are also available for bacterial and fungal proteins.

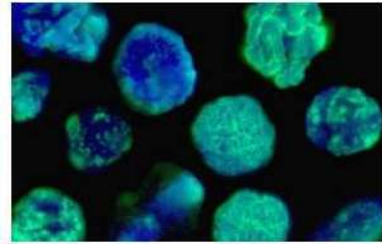

Secondary antibodies

Discover Agrisera's vast collection of validated, high-quality secondary antibodies. These are offered both conjugated and unconjugated, for luminescent, fluorescent and chromogenic detection in a wide range of applications.

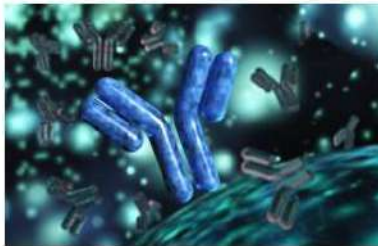

Antibody production

Agrisera has produced thousands of custom monoclonal and polyclonal antibodies. With our own animal facilities and in-house immunological services, we can offer antibody production for almost any research area and scale needed.

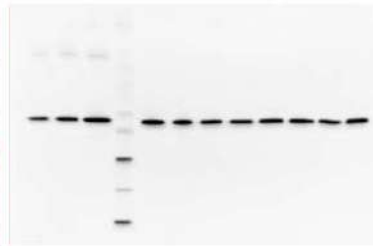

Detection reagents

Check out Agrisera's high-quality detection reagents for Western Blot and ELISA, available in different volumes and sensitivity ranges to match your research requirements.



New products

Agrisera continuously develop new products to expand our collection of antibodies to plant science. This list is regularly updated.

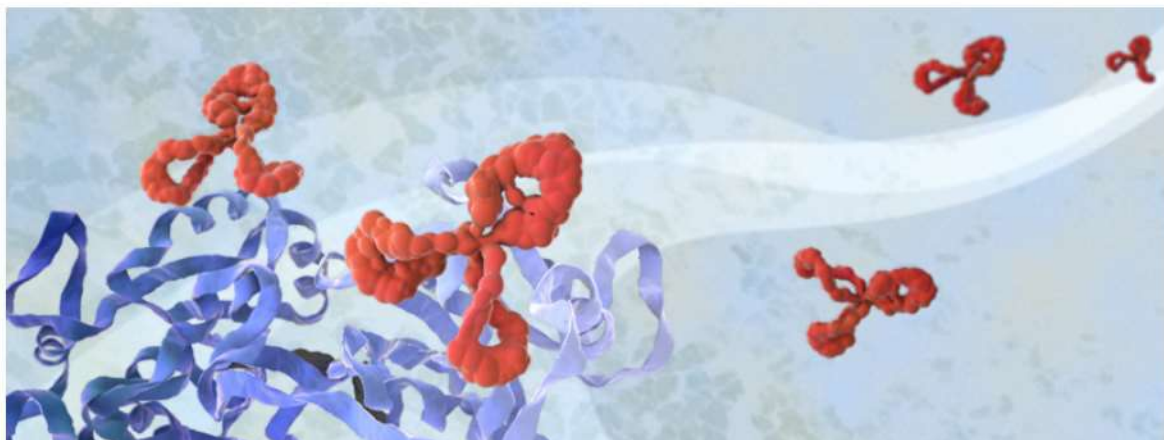

Antibody Production

Over the last 30 years, Agrisera has produced thousands of custom monoclonal and custom polyclonal antibodies for academic research worldwide as well as industry, diagnostics, and pharma. With our own animal facilities and in-house immunological services, we can offer antibody production for almost any research area and scale needed. A list of chosen scientific references for antibodies produced at Agrisera can be found [here](#).

Blood Collection Tubes & Accessories



Needle Holders



Butterfly Needle



MSN Needle



Flashback Needle



Ultimate Blood Collection Tubes



Luer Adapter



Pediatric Blood Collection Tubes



Lancet



PRP / PRF / DNA / RNA
Tubes

Plastic - Lab Consumables



Centrifuge Tubes



Sample Vials



Cryo Vials



Coplin Jar



Vial With Screw Cap



Multipurpose Vial



Ria Vials



Measuring Cylinder



Urine Containers

Glass - Lab Consumables



Glass Petri Dish



Glass Tube



Microscope Cover Glasses



Microscope Slides

Miscellaneous Products



Alcohol Swab



Injection Plaster



Thermal Papers



Latex Tourniquet



Button Tourniquet



Velcro Tourniquet



Needle Destroyer



Micro Pipette Fixed & Variable

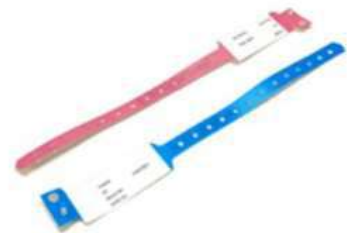

Patient ID

Plastic - Lab Consumables



Urine Culture Container



Stool Containers



Analyser Cups & Cuvettes



Petri Dishes



Micro Pipette Tips



Pasteur Pipettes



ESR Disposable Pipette



Micro Pipette Stands



Micro Centrifuge Tubes

Plastic - Lab Consumables



Umbilical Cord Clamp



Embedding Cassette



Embedding Rings



Swab Sticks



Pap Smear Kit



Tip Boxes



Test Tube Racks



ESR Stand



Slide Boxes



Wash Bottles



Dropper Bottles



Test Tube Stoppers

Cat. No.	Product Description	Pack Size	Price
AS00 001	FVIIa Coagulation factor VIIa (50 µg)	50 µg	53875
AS00 001	FVIIa Coagulation factor VIIa (50 µg) (2 Units)	50 µg	41483
AS00 001	FVIIa Coagulation factor VIIa (50 µg) (3 Units or More)	50 µg	38730
AS00 001-500	FVIIa Coagulation factor VIIa (500 µg)	500 µg	295690
AS01 001	ClpC Chloroplastic form of HSP100	100 µl	64546
AS01 002	Lhcb3 LHCII type III chlorophyll a/b-binding protein	200 µl	64546
AS01 002PRE	Lhcb3 LHCII type III chlorophyll a/b-binding protein, preimmune serum	200 µl	25305
AS01 003	Lhcb2 LHCII type II chlorophyll a/b-binding protein	200 µl	64546
AS01 004	Lhcb1 LHCII type I chlorophyll a/b-binding protein	50 µg	53875
AS01 004	Lhcb1 LHCII type I chlorophyll a/b-binding protein (2 Units)	50 µg	41483
AS01 004	Lhcb1 LHCII type I chlorophyll a/b-binding protein (3 Units or More)	50 µg	38730
AS01 004PRE	Lhcb1 LHCII type I chlorophyll a/b-binding protein, preimmune serum	100 µl	26165
AS01 005	Lhca1 PSI type I chlorophyll a/b-binding protein	0.5 mg	64891
AS01 006	Lhca2 PSI type II chlorophyll a/b-binding protein	0.5 mg	64546
AS01 007	Lhca3 PSI type III chlorophyll a/b-binding protein	200 µl	64546
AS01 008	Lhca4 PSI type IV chlorophyll a/b-binding protein	200 µl	64546
AS01 009	Lhcb5 CP26 chlorophyll a/b-binding protein of plant PSII	200 µl	64546
AS01 009PRE	Lhcb5 CP26 chlorophyll a/b-binding protein of plant PSII, pre-immune serum	200 µl	25305
AS01 010	Lhcb6 CP24 chlorophyll a/b-binding protein of plant PSII	50 µl	53875
AS01 010	Lhcb6 CP24 chlorophyll a/b-binding protein of plant PSII (2 Units)	50 µl	41483
AS01 010	Lhcb6 CP24 chlorophyll a/b-binding protein of plant PSII (3 Units or More)	50 µl	38730
AS01 011	2 Set of 10 plant anti-Lhca and anti-Lhcb antibodies	6 x 200 µl + 1 x 10	313418
AS01 011 CHLAMY	2 Set of 4 Chlamydomonas anti-Lhc antibodies	50 µl (Lhcb5, Lhcb)	213422
AS01 012	DS5a Drosophila 26S proteasome subunit Rpn10	50 µl	53875
AS01 012	DS5a Drosophila 26S proteasome subunit Rpn10 (2 Units)	50 µl	41483
AS01 012	DS5a Drosophila 26S proteasome subunit Rpn10 (3 Units or More)	50 µl	38730
AS01 013	AMBP Alpha-1-microglobulin (clone BN11.10)	50 µg	62825
AS01 014	AMBP Alpha-1-microglobulin	200 µl	64546
AS01 015	A1AGP Alpha-1-acid glycoprotein	200 µl	64546
AS01 016	PsbA D1 protein of PSII, C-terminal (chicken)	100 µl	69365
AS01 016S	PsbA D1 positive control/quantitation standard		36664
AS01 016S	PsbA D1 positive control/quantitation standard (2 Units)		30640
AS01 016S	PsbA D1 positive control/quantitation standard (3 Units or More)		27199
AS01 017	RbcL Rubisco large subunit, form I	50 µl	68505
AS01 017S	RbcL Rubisco positive control/quantitation standard	100 µl	36664
AS01 017S	RbcL Rubisco positive control/quantitation standard (2 Units)	100 µl	30640
AS01 017S	RbcL Rubisco positive control/quantitation standard (3 Units or More)	100 µl	27199
AS01 018	GlnA Glutamine synthetase	50 µl (16 mg/ml)	53875
AS01 018	GlnA Glutamine synthetase (2 Units)	50 µl (16 mg/ml)	41483
AS01 018	GlnA Glutamine synthetase (3 Units or More)	50 µl (16 mg/ml)	38730
AS01 019	S5a human 26S proteasome subunit	100 µl	64546
AS01 020	Helicobacter pylori	200 µl	64546
AS01 021A	NifH Nitrogenase iron protein	200 µg	73151

Cat. No.	Product Description	Pack Size	Price
AS01 021S	NifH Positive control/quantitation standard	250 µl	49228
AS02 023	BSA Bovine serum albumin	50 µl (6.24 ug/µl)	73151
AS03 027	Chicken IgY pre-immune IgY (50 mg)	50 mg	31329
AS03 029	SCGB2A2 Mammaglobin-A	100 µg	73151
AS03 029S	SCGB2A2 Mammaglobin-A, Blocking peptide for antimammaglobin antibodies	100 µg (0.6 µg/µl)	38041
AS03 030	AtpB Beta subunit of ATP synthase (chloroplasic + mitochondrial) (chicken)	100 µl	68505
AS03 030S	AtpB Positive control/quantitation standard	100 µl	36664
AS03 031	mPGES-1 glutathione dependent prostaglandin E synthase	50 µl	53875
AS03 031	mPGES-1 glutathione dependent prostaglandin E synthase (2 Units)	50 µl	41483
AS03 031	mPGES-1 glutathione dependent prostaglandin E synthase (3 Units or More)	50 µl	38730
AS03 031-1ml	mPGES-1 glutathione dependent prostaglandin E synthase (1ml)	1 ml	549037
AS03 031S	mPGES-1 glutathione dependent prostaglandin E synthase protein positive control	50 µl (21 µg)	38041
AS03 032	PsbS 22 kDa Lhc-like PSII protein (chicken)	100 µl	68505
AS03 035A	SPS Sucrose phosphate synthase, global	50 µg	73151
AS03 035-ALP	SPS Sucrose phosphate synthase, global, ALPconjugated (40 µg)	40 µg	79520
AS03 035-HRP	SPS Sucrose phosphate synthase, global, HRPconjugated (40 µg)	40 µg	79520
AS03 036	Elip2 Early light inducible protein 2	200 µl	68505
AS03 037	RbcL Rubisco large subunit, form I and form II	50 µl	52671
AS03 037	RbcL Rubisco large subunit, form I and form II (2 Units)	50 µl	39417
AS03 037	RbcL Rubisco large subunit, form I and form II (3 Units or More)	50 µl	36664
AS03 037A	RbcL Rubisco large subunit, form I and form II (affinity purified)	50 µg	53875
AS03 037A	RbcL Rubisco large subunit, form I and form II (affinity purified) (2 Units)	50 µg	41483
AS03 037A	RbcL Rubisco large subunit, form I and form II (affinity purified) (3 Units or More)	50 µg	38730
AS03 037-ALP	RbcL Rubisco large subunit, form I and form II, ALPconjugated (40 µg)	40 µg	79520
AS03 037B	RbcL Rubisco large subunit, form I and form II, Biotin conjugated (40 µg)	40 µg	79520
AS03 037-HRP	RbcL Rubisco large subunit, form I and form II, HRPconjugated (40 µg)	40 µg	79520
AS03 037PRE	Rubisco large subunit, pre-immune serum	100 µl	26165
AS04 038	PsbB CP47 protein of PSII	50 µl	69365
AS04 038PRE	PsbB CP47 protein of PSII, pre-immune serum	100 µl	26165
AS04 039	AMBP Bikunin	200 µl	79348
AS04 040	AMBP Bikunin (mice)	200 µl	79348
AS04 041	THP Allopregnanolone	100 µl	73151
AS04 041S	THP Allopregnanolone steroid standard	10 mg	49228
AS04 042P	PsaC PSI-C core subunit of photosystem I (PsaC antibody + PsaC protein positive control)	50 µl anti-PsaC an	69365
AS04 042S	PsaC positive control/quantitation standard	100 µl	49228
AS04 043	cFBPase Cytosolic fructose-1,6-bisphosphatase (cytoplasm marker in photosynthetic tissues)	50 µl	52671
AS04 043	cFBPase Cytosolic fructose-1,6-bisphosphatase (cytoplasm marker in photosynthetic tissues) (2 Units)	50 µl	41139
AS04 043	cFBPase Cytosolic fructose-1,6-bisphosphatase (cytoplasm marker in photosynthetic tissues) (3 Units or More)	50 µl	38730

Cat. No.	Product Description	Pack Size	Price
AS04 045	Lhcb4 CP29 chlorophyll a/b binding protein of plant PSII	0.5 mg	64891
AS04 045PRE	Lhcb4 CP29 chlorophyll a/b binding protein of plant PSII, pre-immune serum	200 µl	25305
AS04 047	PsaE PSI-E subunit of photosystem I	100 µl	64546
AS04 048	PsaG PSI-G subunit of photosystem I	100 µl	64546
AS04 049	PsaK PSI-K subunit of photosystem I	100 µl	64546
AS04 050	PsaO PSI-O subunit of photosystem I	100 µl	64546
AS04 051	2 Photosynthesis Tool Kit - quantitation	50 µl of respective	159723
AS04 052	COXII Cytochrome oxidase subunit II (plant)	100 µl	68505
AS04 053A	COXII Plant Cytochrome oxidase subunit II (affinity purified)	50 µg	53875
AS04 053A	COXII Plant Cytochrome oxidase subunit II (affinity purified) (2 Units)	50 µg	39417
AS04 053A	COXII Plant Cytochrome oxidase subunit II (affinity purified) (3 Units or More)	50 µg	36664
AS04 053A-200	COXII Cytochrome oxidase subunit II (200 µg)	200 µg	127366
AS04 053P	COXII Cytochrome oxidase subunit II, Blocking peptide	500 µg (2 mg/ml)	23412
AS04 053PRE	COXII Cytochrome oxidase subunit II, pre-immune serum	100 µl	26165
AS04 054	AOX1/2 Plant alternative oxidase 1 and 2	50 µl	53875
AS04 054	AOX1/2 Plant alternative oxidase 1 and 2 (2 Units)	50 µl	41483
AS04 054	AOX1/2 Plant alternative oxidase 1 and 2 (3 Units or More)	50 µl	38730
AS04 054PRE	AOX1/2 Plant alternative oxidase 1 and 2, pre-immune serum	100 µl	26165
AS04 054S	AOX AOX positive control/quantitation standard	120 µl	36664
AS04 054S	AOX AOX positive control/quantitation standard (2 Units)	120 µl	30640
AS04 054S	AOX AOX positive control/quantitation standard (3 Units or More)	120 µl	27199
AS04 055	GPX Glutathione peroxidase (chloroplatic)	100 µl	68505
AS05 056	ExoS Exoenzyme S	100 µl	73151
AS05 057	Yersinia pseudotuberculosis	200 µl	68505
AS05 059	PsbR 10 kDa protein of PSII	100 µl	68505
AS05 060	PsbW Small subunit W of PSII	100 µl	68505
AS05 061	HSP70 salmonid heat shock protein 70	100 µl	68505
AS05 061A	HSP70 Salmonid heat shock protein 70, Affinity purified	200 µg	73151
AS05 062	HSC70 salmon heat shock cognate protein 70	100 µl	68505
AS05 063	HSP90 Heat shock protein 90	100 µl	66439
AS05 065R	ER Estrogen receptor	100 µg	73151
AS05 066	PsbX small subunit X of PSII	200 µl	68505
AS05 067	POR Protochlorophillide oxidoreductase	50 µl	53875
AS05 067	POR Protochlorophillide oxidoreductase (2 Units)	50 µl	41483
AS05 067	POR Protochlorophillide oxidoreductase (3 Units or More)	50 µl	38730
AS05 067-10	POR Protochlorophillide oxidoreductase (10 µl)	10 µl	33050
AS05 068	GDH1 Glutamate dehydrogenase 1	100 µl	68505
AS05 070	2 Educational antibody kit - photosynthesis	10 or 50 µl / tube	265485
AS05 071	AtpH ATP synthase subunit c (chloroplatic)	200 µl	68505
AS05 073	CAH3 Carbonic anhydrase	100 µl	68505
AS05 074	GDC-H H protein of glycine decarboxylase complex (GDC)	200 µg	63170
AS05 075	SHMT Serine hydroxymethyltransferase	0.5 mg	68505
AS05 077	NCAM 2 Neural cell adhesion molecule 2	100 µg	89847
AS05 078	MYST4 histone acetyltransferase KAT6B	100 µg	79348
AS05 079	STC-1 stanniocalcin-1	100 µl	73151
AS05 081	CPX2 Coproporphyrinogen III oxidase, isoform 2	100 µl	68505

Cat. No.	Product Description	Pack Size	Price
AS05 082	Lhca5 PSI type V chlorophyll a/b-binding protein	200 µl	64546
AS05 083	HSP70/HSC70 Heat shock protein 70/Heat shock cognate protein 70 (serum)	100 µl	66268
AS05 083A	HSP70/HSC70 Heat shock protein 70/Heat shock cognate protein 70, Affinity purified	50 µg	53875
AS05 083A	HSP70/HSC70 Heat shock protein 70/Heat shock cognate protein 70, Affinity purified (2 Units)	50 µg	41483
AS05 083A	HSP70/HSC70 Heat shock protein 70/Heat shock cognate protein 70, Affinity purified (3 Units or More)	50 µg	38730
AS05 084	PsbA D1 protein of PSII, C-terminal (rabbit antibody) (thylakoid membrane marker)	50 µl	53875
AS05 084	PsbA D1 protein of PSII, C-terminal (rabbit antibody) (thylakoid membrane marker) (2 Units)	50 µl	41483
AS05 084	PsbA D1 protein of PSII, C-terminal (rabbit antibody) (thylakoid membrane marker) (3 Units or More)	50 µl	38730
AS05 084A	PsbA D1 protein of PSII, C-terminal (affinity purified)	50 µg	53875
AS05 084A	PsbA D1 protein of PSII, C-terminal (affinity purified) (2 Units)	50 µg	41483
AS05 084A	PsbA D1 protein of PSII, C-terminal (affinity purified) (3 Units or More)	50 µg	38730
AS05 084A-ALP	PsbA D1 protein of PSII, C-terminal, ALP-conjugated (40 µg)	40 µg	79520
AS05 084A-HRP	PsbA D1 protein of PSII, C-terminal, HRP-conjugated (40 µg)	40 µg	75906
AS05 084PRE	PsbA D1 protein of PSII, C-terminal, pre-immune serum	100 µl	26165
AS05 085	AtpB Beta subunit of ATP synthase (chloroplasmic + mitochondrial) (rabbit)	50 µl	53875
AS05 085	AtpB Beta subunit of ATP synthase (chloroplasmic + mitochondrial) (rabbit) (2 Units)	50 µl	41483
AS05 085	AtpB Beta subunit of ATP synthase (chloroplasmic + mitochondrial) (rabbit) (3 Units or More)	50 µl	38730
AS05 085-10	AtpB Beta subunit of ATP synthase (chloroplasmic + mitochondrial) (rabbit) (10 µl)	10 µl	32018
AS05 085PRE	AtpB Beta subunit of ATP synthase, pre-immune serum	100 µl	26165
AS05 086	UGPase UDP-glucose pyrophosphorylase (cytoplasm marker)	50 µl	53875
AS05 086	UGPase UDP-glucose pyrophosphorylase (cytoplasm marker) (2 Units)	50 µl	41483
AS05 086	UGPase UDP-glucose pyrophosphorylase (cytoplasm marker) (3 Units or More)	50 µl	38730
AS05 087	GnRHa gonadotropin-releasing hormone agonist (200 µl)	200 µl	73151
AS05 087-20	GnRHa gonadotropin-releasing hormone agonist (20 µl)	20 µl	33050
AS05 088	GnRHa gonadotropin-releasing hormone agonist	200 µl	73151
AS05 090	Lci5 low carbon dioxide induced protein number 5	100 µl	68505
AS05 092	PsbO 33 kDa of the oxygen evolving complex (OEC) of PSII (anti-peptide)	100 µl	68505
AS05 093	PrxQ Peroxiredoxin, thioredoxin reductase	200 µl	68505
AS05 094A	FtsH6 ATP-dependent zinc metalloprotease FtsH6 (chloroplasmic)	2x100 µg	68505
AS05 095	STC-1 stanniocalcin-1	100 µl	73151
AS05 096	TOP2 DNA topoisomerase II	200 µl	68505
AS06 101	KLK14 Kallikrein 14	100 µg	73151
AS06 102	KLK5 Kallikrein 5	200 µl	68505
AS06 103	rpro-KLK5 pro-Kallikrein 5	200 µl	68505
AS06 104	PsaF PSI-F subunit of photosystem I	200 µl	68505
AS06 105	PsaH PSI-H subunit of photosystem I (plants)	200 µl	68505

Cat. No.	Product Description	Pack Size	Price
AS06 108	PsaL PSI-L subunit of photosystem I	200 µl	68505
AS06 109	PsaN PSI-N subunit of photosystem I	200 µg	68505
AS06 111	CP43' IsiA homolog of plant CP43	200 µg	73151
AS06 112	PsbE Alfa subunit of Cytochrome b559 of PSII	50 µl	53875
AS06 112	PsbE Alfa subunit of Cytochrome b559 of PSII (2 Units)	50 µl	41483
AS06 112	PsbE Alfa subunit of Cytochrome b559 of PSII (3 Units or More)	50 µl	38730
AS06 113	PsbF beta subunit of Cytochrome b559 of PSII	200 µl	68505
AS06 114	PsbY Small subunit Y of PSII	200 µl	68505
AS06 115	PsbZ ycf9 protein of PSII	200 µl	68505
AS06 116	PGL35 Plastoglobulin 35; FIB1a; FBN1a	200 µl	73151
AS06 117	Lhcb4 CP29 (Lhcb4) homolog, Chlamydomonas	100 µl	64546
AS06 118	Pre-apoplastocyanin	200 µl	68505
AS06 119	Cyt f Cytochrome f protein (PetA) of thylakoid Cyt b6/fcomplex (algal)	50 µl	68505
AS06 120	FOX1 plasma membrane ferroxidase FLP1	200 µl	68505
AS06 121	FDX1 Ferredoxin	50 µl	53875
AS06 121	FDX1 Ferredoxin (2 Units)	50 µl	41483
AS06 121	FDX1 Ferredoxin (3 Units or More)	50 µl	38730
AS06 122	CRD1 Cyanobacterial homolog of plant CHL27 cyclase	50 µl	53875
AS06 122	CRD1 Cyanobacterial homolog of plant CHL27 cyclase (2 Units)	50 µl	41483
AS06 122	CRD1 Cyanobacterial homolog of plant CHL27 cyclase (3 Units or More)	50 µl	38730
AS06 123	CPX1 coproporphyrinogen III oxidase, isoform 1	100 µl	68505
AS06 125	FeSOD Chloroplasic Fe-dependent superoxide dismutase	50 µl	53875
AS06 125	FeSOD Chloroplasic Fe-dependent superoxide dismutase (2 Units)	50 µl	41483
AS06 125	FeSOD Chloroplasic Fe-dependent superoxide dismutase (3 Units or More)	50 µl	38730
AS06 126	Fer1 Ferritin 1 (pre-apoferritin)	200 µl	68505
AS06 127	VTG Sole vitellogenin	200 µl	68505
AS06 128	LOX Lipoygenase	50 µl	53875
AS06 128	LOX Lipoygenase (2 Units)	50 µl	41483
AS06 128	LOX Lipoygenase (3 Units or More)	50 µl	38730
AS06 128A	LOX Lipoygenase (Affinity purified)	50 µg	56456
AS06 128A	LOX Lipoygenase (Affinity purified) (2 Units)	50 µg	43033
AS06 128A	LOX Lipoygenase (Affinity purified) (3 Units or More)	50 µg	39417
AS06 130	FtsH9 ATP-dependent zinc metalloprotease FtsH9 (chloroplasic)	2x200 µg	68505
AS06 136	HYL1 Hyponastic leave phenotype ds-RNA binding protein	50 µl	53875
AS06 136	HYL1 Hyponastic leave phenotype ds-RNA binding protein (2 Units)	50 µl	41483
AS06 136	HYL1 Hyponastic leave phenotype ds-RNA binding protein (3 Units or More)	50 µl	38730
AS06 141	PC Plastocyanin	50 µl	53875
AS06 141	PC Plastocyanin (2 Units)	50 µl	41483
AS06 141	PC Plastocyanin (3 Units or More)	50 µl	38730
AS06 142-16	PsbQ 16 kDa protein of the oxygen evolving complex (OEC) of PSII	200 µl	68505
AS06 142-23	PsbP 23 kDa protein of the oxygen evolving complex (OEC) of PSII (anti-protein)	260 µg	68505
AS06 142-23	PsbP 23 kDa protein of the oxygen evolving complex (OEC) of PSII (anti-protein) (2 Units)	260 µg	41483
AS06 142-23	PsbP 23 kDa protein of the oxygen evolving complex (OEC) of PSII (anti-protein) (3 Units or More)	260 µg	38730

Cat. No.	Product Description	Pack Size	Price
AS06 142-33	PsbO 33 kDa of the oxygen evolving complex (OEC) of PSII (anti-protein)	50 µl	53875
AS06 143	PsaH PSI-H subunit of photosystem I, Chlamydomonas	200 µl	68505
AS06 144	PsaG PSI-G subunit of photosystem I, Chlamydomonas	200 µl	68505
AS06 145	LTP vesicle-inducing protein in plastids (VIPP1)	200 µl	68505
AS06 146	PsbD D2 protein of PSII	50 µl	53875
AS06 146	PsbD D2 protein of PSII (2 Units)	50 µl	41483
AS06 146	PsbD D2 protein of PSII (3 Units or More)	50 µl	38730
AS06 146PRE	PsbD D2 protein of PSII, pre-immune serum	100 µl	26165
AS06 147A	Elip Early light induced protein	100 µg	53875
AS06 147A	Elip Early light induced protein (2 Units)	100 µg	41483
AS06 147A	Elip Early light induced protein (3 Units or More)	100 µg	38730
AS06 151	COXIIb Algal Cytochrome oxidase subunit II b	50 µl	53875
AS06 151	COXIIb Algal Cytochrome oxidase subunit II b (2 Units)	50 µl	41483
AS06 151	COXIIb Algal Cytochrome oxidase subunit II b (3 Units or More)	50 µl	38730
AS06 152	AOX1 Algal Alternative oxidase 1	100 µl	68505
AS06 153	CDC2 Cell-division-cycle kinase 2	100 µl	68505
AS06 154	PEN2 gamma-secretase subunit PEN-2	100 µg	64546
AS06 155	hScrib Protein LAP4	100 µl	68505
AS06 156	LRIG1 Lig-1	200 µg (1.5 µg/µl)	89847
AS06 157	PsbH Small subunit H of PSII	100 µl	68505
AS06 158	PsbI Small subunit I of PSII	200 µl	68505
AS06 159	NtrC Thioredoxin reductase (TR/TRxR) (algal)	200 µg	73151
AS06 163	Hcf101 High chlorophyll fluorescence phenotype protein	200 µl	68505
AS06 167	PsbP 23 kDa protein of the oxygen evolving complex (OEC) of PSII (anti-peptide)	100 µl	68505
AS06 169	COR14b Cor14b-encoded cold regulated protein	100 µl	68505
AS06 170	CSD2 Chloroplatic Cu/Zn superoxide dismutase	50 µl	53875
AS06 170	CSD2 Chloroplatic Cu/Zn superoxide dismutase (2 Units)	50 µl	41483
AS06 170	CSD2 Chloroplatic Cu/Zn superoxide dismutase (3 Units or More)	50 µl	38730
AS06 171	PsbTn Tn protein of PSII	200 µl	68505
AS06 172	PsaA PSI-A core protein of photosystem I	50 µl	53875
AS06 172	PsaA PSI-A core protein of photosystem I (2 Units)	50 µl	41483
AS06 172	PsaA PSI-A core protein of photosystem I (3 Units or More)	50 µl	38730
AS06 173	AMBP Bikunin (50 µl)	50 µl	53875
AS06 173	AMBP Bikunin (50 µl) (2 Units)	50 µl	41483
AS06 173	AMBP Bikunin (50 µl) (3 Units or More)	50 µl	38730
AS06 174	HSP90C alfa-HSP90C, heat shock protein (algal)	100 µl	68505
AS06 175	HSP70B Stromal alfa-HSP70 (algal)	100 µl	68505
AS06 176	CGE1 Alfa-CGE1, chloroplatic GrpE homolog	100 µl	68505
AS06 178	HSF1 Heat shock factor 1	100 µl	68505
AS06 179	CDJ1 chloroplast DnaJ homolog 1	100 µl	68505
AS06 180	cAPX Ascorbate peroxidase (cytosolic)	200 µl	68505
AS06 181	GR Glutathione reductase	100 µl	69365
AS06 182	GLDH Galactono-1,4 lactone dehydrogenase	100 µl	68505
AS06 183	GS Glutathione synthase, GSH-S	100 µl	68505
AS06 185	SPS Sucrose phosphate synthase (maize)	50 µl	53875
AS06 185	SPS Sucrose phosphate synthase (maize) (2 Units)	50 µl	41483
AS06 185	SPS Sucrose phosphate synthase (maize) (3 Units or More)	50 µl	38730
AS06 186	Gamma-ECS Gamma glutamylcysteine synthase	100 µl	68505
AS06 192	THDOC Tetrahydrodeoxycorticosterone	100 µl	68505

Cat. No.	Product Description	Pack Size	Price
AS06 193	IAA Indole 3 acetic acid	100 µl	102259
AS06 195	ABA Abscisic acid	100 µl	102259
AS06 196	Fer2 ferritin 2	200 µl	68505
AS06 198	FT/TSF Flowering locus T and twin sister of FT	50 µg	53875
AS06 198	FT/TSF Flowering locus T and twin sister of FT (2 Units)	50 µg	41483
AS06 198	FT/TSF Flowering locus T and twin sister of FT (3 Units or More)	50 µg	38730
AS06 202	Cyt c6 Thylakoid lumen cytochrome c6 protein	200 µl	68505
AS06 203A	IDH Isocitrate dehydrogenase	50 µg	53875
AS06 203A	IDH Isocitrate dehydrogenase (2 Units)	50 µg	41483
AS06 203A	IDH Isocitrate dehydrogenase (3 Units or More)	50 µg	38730
AS07 204	FtsH3 + FtsH10 ATP-dependent zinc metalloprotease FtsH3 + FtsH10 (mitochondrial)	200 µg	68505
AS07 205	FtsH4 ATP-dependent zinc metalloprotease FtsH4 (mitochondrial)	200 µg	68505
AS07 206	Dehydrin (serum)	200 µl	68505
AS07 206A	Dehydrin (affinity purified serum)	50 µg	53875
AS07 206A	Dehydrin (affinity purified serum) (2 Units)	50 µg	41483
AS07 206A	Dehydrin (affinity purified serum) (3 Units or More)	50 µg	38730
AS07 207	PR-3 / CHN Class I chitinase	2 mg	68505
AS07 208	PR-2 GLU I Class I beta-1,3-glucanase	2 mg	68505
AS07 212	VDAC1 Voltage-dependent anion-selective channel protein 1	50 µg	53875
AS07 212	VDAC1 Voltage-dependent anion-selective channel protein 1 (2 Units)	50 µg	41483
AS07 212	VDAC1 Voltage-dependent anion-selective channel protein 1 (3 Units or More)	50 µg	38730
AS07 212-ALP	VDAC1 Voltage-dependent anion-selective channel protein 1, ALP-conjugated (40 µg)	40 µg	79520
AS07 212-HRP	VDAC1 Voltage-dependent anion-selective channel protein 1, HRP-conjugated (40 µg)	40 µg	79520
AS07 213	V-ATPase Epsilon subunit of tonoplast H+ATPase	50 µl	53875
AS07 213	V-ATPase Epsilon subunit of tonoplast H+ATPase (2 Units)	50 µl	41483
AS07 213	V-ATPase Epsilon subunit of tonoplast H+ATPase (3 Units or More)	50 µl	38730
AS07 213P	V-ATPase epsilon subunit of tonoplast H+ATPase, Blocking peptide	500 µg (2 µg/µl)	23412
AS07 214	RFA Baker's yeast replication factor A	50 µl	53875
AS07 214	RFA Baker's yeast replication factor A (2 Units)	50 µl	41483
AS07 214	RFA Baker's yeast replication factor A (3 Units or More)	50 µl	38730
AS07 217	FtsZ Prokaryotic cell division GTPase (cyanobacterial)	200 µl	69365
AS07 218	Rubisco 557 kDa hexadecamer	200 µl	64546
AS07 219	CCS Chloroplastic copper chaperone for SOD	200 µl	68505
AS07 220	PhyA Phytochrome A	200 µg	68505
AS07 223	Fdx6 ferredoxin 6	200 µg	68505
AS07 224	Fdx3 ferredoxin 3	200 µg	68505
AS07 225	A12.2 RNA polymerase I subunit (homolog of Pol II Rpb9)	200 µg	73151
AS07 226	HemF Coproporphyrinogen III oxidase	200 µl	68505
AS07 227	HemY protoporphyrinogen oxidase	200 µl	68505
AS07 228	HemH Protoporphyrin ferrochelatase	200 µl	68505
AS07 233	HSC70/HSP70 Heat shock cognate protein 70 / heat shock protein 70	100 µl	68505
AS07 235	Toc34 chloroplast outer envelope membrane translocon complex protein (soluble domain)	50 µl	68505
AS07 236	Toc33 chloroplast outer envelope membrane translocon complex protein	50 µl	68505

Cat. No.	Product Description	Pack Size	Price
AS07 237	Toc34 chloroplast outer envelope membrane translocon complex protein (denatured domain)	50 µl	68505
AS07 238	Toc34 Chloroplast outer envelope membrane translocon complex protein (GTPase domain)	50 µl	68505
AS07 239	Toc159 Chloroplast outer envelope membrane translocon complex protein	50 µl	68505
AS07 240	Psb29 Thylakoid membrane formation 1, THF1	200 µg	68505
AS07 241	PEPCK PEP carboxykinase	200 µl	68505
AS07 242	GOGAT Glutamine oxoglutarate aminotransferase	50 µl	53875
AS07 242	GOGAT Glutamine oxoglutarate aminotransferase (2 Units)	50 µl	41483
AS07 242	GOGAT Glutamine oxoglutarate aminotransferase (3 Units or More)	50 µl	38730
AS07 243	NtrC Thioredoxin reductase (TR/TRxR) (higher plants)	200 µg	73151
AS07 243	NtrC Thioredoxin reductase (TR/TRxR) (higher plants) (2 Units)	200 µg	41483
AS07 243	NtrC Thioredoxin reductase (TR/TRxR) (higher plants) (3 Units or More)	200 µg	38730
AS07 244	SLT2 Sodium sulfate transporter	200 µg	73151
AS07 246	Deg1 chloroplastic DegP-type serine protease 1	360 µg	68505
AS07 250	LHL4 LHC-like protein 4	200 µl	68505
AS07 251	FtsH10 ATP-dependent zinc metalloprotease FtsH10 (mitochondrial)	200 µl	68505
AS07 253	HSP101 ClpB heat shock protein, N-terminal (rabbit antibody)	50 µl	53875
AS07 254	HSP17.6 Cytosolic class I heat shock protein 17.6 (rabbit antibody)	50 µl	53875
AS07 254	HSP17.6 Cytosolic class I heat shock protein 17.6 (rabbit antibody) (2 Units)	50 µl	41483
AS07 254	HSP17.6 Cytosolic class I heat shock protein 17.6 (rabbit antibody) (3 Units or More)	50 µl	38730
AS07 255	HSP17.7 Cytosolic class II heat shock protein 17.7	50 µl	53875
AS07 255	HSP17.7 Cytosolic class II heat shock protein 17.7 (2 Units)	50 µl	41483
AS07 255	HSP17.7 Cytosolic class II heat shock protein 17.7 (3 Units or More)	50 µl	38730
AS07 256	SAL1 Sal1 phosphatase	100 µl	68505
AS07 257	PRK ribulose-5-P-kinase Phosphoribulokinase	50 µg	53875
AS07 257	PRK ribulose-5-P-kinase Phosphoribulokinase (2 Units)	50 µg	41483
AS07 257	PRK ribulose-5-P-kinase Phosphoribulokinase (3 Units or More)	50 µg	38730
AS07 257-ALP	PRK ribulose-5-P-kinase phosphoribulokinase, ALPconjugated (40 µg)	40 µg	79520
AS07 257-HRP	PRK ribulose-5-P-kinase Phosphoribulokinase, HRPconjugated (40 µg)	40 µg	79520
AS07 258	LOX-C Lipoxygenase (chloroplastic)	100 µl	68505
AS07 259	RbcS Rubisco small subunit (SSU)	50 µl	53875
AS07 259	RbcS Rubisco small subunit (SSU) (2 Units)	50 µl	41483
AS07 259	RbcS Rubisco small subunit (SSU) (3 Units or More)	50 µl	38730
AS07 259A	RbcS Rubisco small subunit (SSU) (affinity purified)	50 µg	53875
AS07 259A	RbcS Rubisco small subunit (SSU) (affinity purified) (2 Units)	50 µg	41483
AS07 259A	RbcS Rubisco small subunit (SSU) (affinity purified) (3 Units or More)	50 µg	38730
AS07 260	H+ATPase Plasma membrane H+ATPase (rabbit antibody)	50 µl	53875
AS07 260	H+ATPase Plasma membrane H+ATPase (rabbit antibody) (2 Units)	50 µl	41483
AS07 260	H+ATPase Plasma membrane H+ATPase (rabbit antibody) (3 Units or More)	50 µl	38730

Cat. No.	Product Description	Pack Size	Price
AS07 260P	H+ATPase plasma membrane H+ATPase, Blocking peptide	500 µg (2 mg/ml)	23412
AS07 260PRE	H+ATPase Plasma membrane H+ATPase, pre-immune serum	100 µl	26165
AS07 265	eEF1b Elongation factor 1-beta	200 µl	68505
AS07 266	SMT1 Sterol methyltransferase 1	100 µg	68505
AS07 267	Xylose	50 µg	82789
AS07 268	Fucose	50 µg	82789
AS07 270	DnaK chloroplast stromal chaperone	50 µl	53875
AS07 270	DnaK chloroplast stromal chaperone (2 Units)	50 µl	41483
AS07 270	DnaK chloroplast stromal chaperone (3 Units or More)	50 µl	38730
AS07 271	DnaJ prokaryotic heat shock protein	200 µl	68505
AS07 272	A1i3 alpha-1-inhibitor 3	200 µg	68505
AS07 273	Ycf3 Photosystem I assembly protein ycf3	200 µl	68505
AS07 274	Ycf4 photosystem I assembly protein ycf4	200 µl	68505
AS07 275	PFOR pyruvate oxidoreductase	200 µg	73151
AS07 276	PTA phosphate acetyltransferase	200 µg	71431
AS08 277	APC allophycocyanin alpha and beta	200 µl	68505
AS08 278	R-PC R-phycocyanin	200 µl	68505
AS08 279	b-PE Phycoerythrobilin	200 µl	68505
AS08 280	B-PE phycoerythrobilin and phycourobilin	200 µl	68505
AS08 281	95 kDa Lcm (phycobilisome - to- thylakoid core linker with phycocyanobilin chromophore)	200 µl	68505
AS08 282	Lhc1 PS 1 light harvesting holo-complex	200 µl	64546
AS08 283	HSP101 ClpB heat shock protein, N-terminal (chicken antibody)	200 µl	68505
AS08 284	HSP17.6 Cytosolic class I heat shock protein 17.6 (chicken antibody)	200 µl	68505
AS08 285	HSP21 Chloroplastic heat shock protein	50 µl	53875
AS08 285	HSP21 Chloroplastic heat shock protein (2 Units)	50 µl	41483
AS08 285	HSP21 Chloroplastic heat shock protein (3 Units or More)	50 µl	38730
AS08 286	HSP16.6 Class I heat shock protein 16.6 (cytosolic)	100 µl	68505
AS08 287	HSP101 ClpB heat shock protein, C-terminal	50 µl	53875
AS08 287	HSP101 ClpB heat shock protein, C-terminal (2 Units)	50 µl	41483
AS08 287	HSP101 ClpB heat shock protein, C-terminal (3 Units or More)	50 µl	38730
AS08 288	ASNA1 Arsenical pump-driving ATPase	200 µl	68505
AS08 289	ZEP Zeaxanthin Epoxidase (anti-peptide)	50 µl	53875
AS08 289	ZEP Zeaxanthin Epoxidase (anti-peptide) (2 Units)	50 µl	41483
AS08 289	ZEP Zeaxanthin Epoxidase (anti-peptide) (3 Units or More)	50 µl	38730
AS08 290	HSP101 nuclear/cytoplasmatic heat shock protein	200 µl	68505
AS08 292	Toc75 Outer chloroplast membrane translocon complex protein	200 µl	68505
AS08 293	Tic110 chloroplast inner envelope membrane translocon complex	200 µl	68505
AS08 294	ALD Fructose-1,6 bisphosphate aldolase	100 µl	68505
AS08 295	GLN1 GLN2 GS1 GS2 glutamine synthetase global antibody	50 µl	53875
AS08 295	GLN1 GLN2 GS1 GS2 glutamine synthetase global antibody (2 Units)	50 µl	41483
AS08 295	GLN1 GLN2 GS1 GS2 glutamine synthetase global antibody (3 Units or More)	50 µl	38730
AS08 295PRE	GLN1 GLN2 GS1 glutamine synthetase, pre-immune serum	100 µl	16182
AS08 296	GLN2 GS2, chloroplastic form of glutamine synthetase	400 µl	68505
AS08 298	CSP41b ribosome associated endonuclease (CRB)	200 µg	68505
AS08 300	1 PEB (4x) protein extraction buffer	5 x 2 ml (4x stock)	23583
AS08 302	NDPK Nucleoside diphosphate kinase	50 µl	53875

Cat. No.	Product Description	Pack Size	Price
AS08 302	NDPK Nucleoside diphosphate kinase (2 Units)	50 µl	41483
AS08 302	NDPK Nucleoside diphosphate kinase (3 Units or More)	50 µl	38730
AS08 304	AtpA Alpha subunit of ATP synthase, chloroplasic	50 µl	68505
AS08 305	PsbP 23 kDa protein of the oxygen evolving complex (OEC) of PSII (anti-monocot protein)	100 µl	68505
AS08 306	Cyt f Cytochrome f protein (PetA) of thylakoid Cyt b6/fcomplex (higher plants)	50 µl	53875
AS08 306	Cyt f Cytochrome f protein (PetA) of thylakoid Cyt b6/fcomplex (higher plants) (2 Units)	50 µl	41483
AS08 306	Cyt f Cytochrome f protein (PetA) of thylakoid Cyt b6/fcomplex (higher plants) (3 Units or More)	50 µl	38730
AS08 307	UBQ11 Ubiquitin	50 µl	53875
AS08 307	UBQ11 Ubiquitin (2 Units)	50 µl	41483
AS08 307	UBQ11 Ubiquitin (3 Units or More)	50 µl	38730
AS08 307A	UBQ11 Ubiquitin (affinity purified)	50 µg	53875
AS08 307A	UBQ11 Ubiquitin (affinity purified) (2 Units)	50 µg	41483
AS08 307A	UBQ11 Ubiquitin (affinity purified) (3 Units or More)	50 µg	38730
AS08 308	SUMO1 Small ubiquitin-like modifier protein 1	1.5 mg	73151
AS08 309	RPS1 30S ribosomal protein S1	50 µl	53875
AS08 309	RPS1 30S ribosomal protein S1 (2 Units)	50 µl	41483
AS08 309	RPS1 30S ribosomal protein S1 (3 Units or More)	50 µl	38730
AS08 310	NR Nitrate reductase, assimilatory	50 µg	53875
AS08 310	NR Nitrate reductase, assimilatory (2 Units)	50 µg	41483
AS08 310	NR Nitrate reductase, assimilatory (3 Units or More)	50 µg	38730
AS08 312	AtpC Gamma subunit of ATP synthase (chloroplasic)	100 µl	68505
AS08 316	CURT1A Curvature thylakoid 1A	200 µg	67300
AS08 317	14.3.3C 14.3.3-like protein C	100 µl	78445
AS08 318	Zip7 Zinc transporter protein Zip7	100 µl	78445
AS08 319	XTH-Xet XET5 Xyloglucan xyloglucosyl transferase	100 µl	78445
AS08 320	Pht1-6 root phosphate transporter isoform 1-6	100 µl	78445
AS08 321	Pht1-1/2 Root phosphate transporter isoform 1-1 and 12	100 µl	78445
AS08 322	Exo1 exoglucanase isoenzyme 1	100 µl	78445
AS08 323	ASY1 Asynaptic phenotype protein 1	100 µl	78445
AS08 324A	PsaE PSI-E subunit of photosystem I (affinity purified)	50 µg	53875
AS08 324A	PsaE PSI-E subunit of photosystem I (affinity purified) (2 Units)	50 µg	41483
AS08 324A	PsaE PSI-E subunit of photosystem I (affinity purified) (3 Units or More)	50 µg	38730
AS08 325	ARF1 ADP-ribosylation factor 1	50 µl	53875
AS08 325	ARF1 ADP-ribosylation factor 1 (2 Units)	50 µl	41483
AS08 325	ARF1 ADP-ribosylation factor 1 (3 Units or More)	50 µl	38730
AS08 325PRE	Arf1 ADP-ribosylation factor 1, pre-immune serum	100 µl	26165
AS08 326	Sar1 Secretion-associated and Ras-related protein 1	200 µl	68505
AS08 327	Sec21p Gamma subunit, COP vesicles	200 µl	69365
AS08 328	Abeta (1-42) Amyloid-beta peptide 1-42	100 µl	58694
AS08 329	Abeta (1-42) Amyloid-beta peptide 1-42	100 µl	58694
AS08 330	PetC Rieske iron-sulfur protein of Cyt b6/f complex	50 µl	53875
AS08 330	PetC Rieske iron-sulfur protein of Cyt b6/f complex (2 Units)	50 µl	41483
AS08 330	PetC Rieske iron-sulfur protein of Cyt b6/f complex (3 Units or More)	50 µl	38730
AS08 330S	PetC Rieske iron-sulfur protein of Cyt b6/f complex, protein standard	250 µl	49228
AS08 331	L7/L12 Ribosomal protein	200 µl	68505
AS08 333	NAB1 nucleic acid binding protein 1, Chlamydomonas	50 µl	53875

Cat. No.	Product Description	Pack Size	Price
AS08 333	NAB1 nucleic acid binding protein 1, Chlamydomonas (2 Units)	50 µl	41483
AS08 333	NAB1 nucleic acid binding protein 1, Chlamydomonas (3 Units or More)	50 µl	38730
AS08 335	Conglutin gamma lupin-specific globulin	50 µl	53875
AS08 335	Conglutin gamma lupin-specific globulin (2 Units)	50 µl	41483
AS08 335	Conglutin gamma lupin-specific globulin (3 Units or More)	50 µl	38730
AS08 338	ASY1 Asynaptic phenotype protein 1 (monoclonal)	50 µg	68182
AS08 339	HDZip1-1 homeodomain-leucine zipper transcription factor	50 µg	68182
AS08 340	LOX2 Lipoxygenase 2	100 µg	68182
AS08 341	VRN2 Vernalization protein 2	100 µg (2x50 µg)	78445
AS08 343A	Cyt c Cytochrome c	50 µg	53875
AS08 343A	Cyt c Cytochrome c (2 Units)	50 µg	41483
AS08 343A	Cyt c Cytochrome c (3 Units or More)	50 µg	38730
AS08 344	slr1641 ATP-dependent chaperone clpB	100 µl	68505
AS08 345	Toc75 Protein TOC75-3, chloroplastic, POTRA domain 1	200 µl	68505
AS08 346	HSP90-1 heat shock protein 90-1	50 µl	53875
AS08 346	HSP90-1 heat shock protein 90-1 (2 Units)	50 µl	41483
AS08 346	HSP90-1 heat shock protein 90-1 (3 Units or More)	50 µl	38730
AS08 347	HSP70 Heat shock protein 70 (mitochondrial)	2 x 50 µg	53875
AS08 348	HSP70 Heat shock protein 70 (chloroplastic)	200 µl	69365
AS08 349	SUMO3 Small ubiquitin-like modifier protein 3	50 µg	53875
AS08 349	SUMO3 Small ubiquitin-like modifier protein 3 (2 Units)	50 µg	41483
AS08 349	SUMO3 Small ubiquitin-like modifier protein 3 (3 Units or More)	50 µg	38730
AS08 350	DnaK2 Heat shock protein 70-2 (HSP70-2)	200 µl	68505
AS08 351	Toc75 Protein TOC75-3, chloroplastic, POTRA domain 3	50 µl	53875
AS08 351	Toc75 Protein TOC75-3, chloroplastic, POTRA domain 3 (2 Units)	50 µl	41483
AS08 351	Toc75 Protein TOC75-3, chloroplastic, POTRA domain 3 (3 Units or More)	50 µl	38730
AS08 355	slr0156 ATP-dependent chaperone clpB	100 µl	68505
AS08 357	Abeta (1-42) Amyloid-beta peptide 1-42	100 µl	58694
AS08 358	SNCA Alpha-synuclein	100 µl	58694
AS08 360	L-cys L-cysteine	100 µl	93547
AS08 365	GTA MCP Gene Transfer Agent (GTA) major capsid protein (MCP)	200 µl	68505
AS08 368	APX L-ascorbate peroxidase	50 µl	53875
AS08 368	APX L-ascorbate peroxidase (2 Units)	50 µl	41483
AS08 368	APX L-ascorbate peroxidase (3 Units or More)	50 µl	38730
AS08 369	Tip18.3 Thylakoid lumen 18.3 kDa protein	200 µl	68505
AS08 370	ATPase ATP synthase, whole enzyme	100 µl	68505
AS08 371	HSP70 Heat shock protein 70 (cytoplasmic)	50 µl	53875
AS08 371	HSP70 Heat shock protein 70 (cytoplasmic) (2 Units)	50 µl	41483
AS08 371	HSP70 Heat shock protein 70 (cytoplasmic) (3 Units or More)	50 µl	38730
AS08 371S	HSP70 Positive control/quantitation standard		36664
AS08 371S	HSP70 Positive control/quantitation standard (2 Units)		30640
AS08 371S	HSP70 Positive control/quantitation standard (3 Units or More)		27199
AS08 372	Pex14p Peroxisomal marker	50 µg	53875
AS08 372	Pex14p Peroxisomal marker (2 Units)	50 µg	41483
AS08 372	Pex14p Peroxisomal marker (3 Units or More)	50 µg	38730
AS08 374	KatG catalase peroxidase (HPI), cyanobacterial	200 µl	68505
AS08 375	HemC Porphobilinogen-Deaminase (PBG)	200 µl	68505
AS09 018S	GlnA glutamine synthetase positive control/quantitation standard	250 µl	49228
AS09 146S	PsbD D2 protein of PSII positive control/quantitation standard	250 µl	49228

Cat. No.	Product Description	Pack Size	Price
AS09 312P	AtpC gamma subunit of ATP synthase, blocking peptide	100 µg (10 µg/µl)	23412
AS09 380	BAM Beta-amylase, Biotin conjugated	1 ml (10 mg/ml)	77282
AS09 383	AO ascorbate oxidase, Biotin conjugated	10 mg	77282
AS09 384	AO ascorbate oxidase	1 mg	91224
AS09 407	Lhcb5 CP26 (Lhcb5) homolog, Chlamydomonas	50 µl	53875
AS09 407	Lhcb5 CP26 (Lhcb5) homolog, Chlamydomonas (2 Units)	50 µl	41483
AS09 407	Lhcb5 CP26 (Lhcb5) homolog, Chlamydomonas (3 Units or More)	50 µl	38730
AS09 408	Lhcbm5 Chlorophyll a-b binding protein of LHCII	50 µl	53875
AS09 408	Lhcbm5 Chlorophyll a-b binding protein of LHCII (2 Units)	50 µl	41483
AS09 408	Lhcbm5 Chlorophyll a-b binding protein of LHCII (3 Units or More)	50 µl	38730
AS09 409	2 Rubisco quantitation kit	1 x 50 µl of AS03	117750
AS09 413	FtsZ1 and 2 Plant cell division protein FtsZ1 and FtsZ2	50 µl	53875
AS09 413	FtsZ1 and 2 Plant cell division protein FtsZ1 and FtsZ2 (2 Units)	50 µl	41483
AS09 413	FtsZ1 and 2 Plant cell division protein FtsZ1 and FtsZ2 (3 Units or More)	50 µl	38730
AS09 414	Cytokinin Trans-zeatin riboside (1mg)	1 mg	61018
AS09 415	Cytokinin N6-isopentenyladenosine (1 mg)	1 mg	61018
AS09 416	Cytokinin Dihydrozeatin riboside (1mg)	1 mg	61018
AS09 417	Cytokinin Meta-topolin riboside (1 mg)	1 mg	61018
AS09 418	Cytokinin Ortho-topolin riboside (1 mg)	1 mg	61018
AS09 419	Cytokinin Cis-zeatin riboside (1mg)	1 mg	61018
AS09 420	IAA Indole-3-acetic acid (C1') (1mg)	1 mg	61018
AS09 421	IAA indole-3-acetic acid (N1) (for immunolocalization)	200 µg	61018
AS09 422	ABA Absciscic acid (C1) (1 mg)	1 mg	61018
AS09 425	Cytokinin N6-benzyladenosine (1 mg)	1 mg	61018
AS09 426	Cytokinin N6-benzyladenosine (5 mg)	5 mg	101098
AS09 428	Cytokinin Trans-zeatin riboside (5mg)	5 mg	101098
AS09 429	Cytokinin Trans-zeatin riboside (for immunolocalization)	200 µg	56177
AS09 430	Cytokinin Cis-zeatin riboside (5mg)	5 mg	125107
AS09 431	Cytokinin Cis-zeatin riboside (for immunolocalization)	200 µg	61018
AS09 434	Cytokinin N6-isopentenyladenosine (5 mg)	5 mg	101098
AS09 435	Cytokinin N6-isopentenyladenosine (for immunolocalization)	200 µg	61018
AS09 436	Cytokinin Dihydrozeatin riboside (5mg)	5 mg	101098
AS09 437	Cytokinin Dihydrozeatin riboside (for immunolocalization)	200 µg	61018
AS09 438	Cytokinin N6-benzyladenosine (for immunolocalization)	200 µg	61018
AS09 439	Cytokinin Meta-topolin riboside (5 mg)	5 mg	101098
AS09 440	Cytokinin Meta-topolin riboside (for immunolocalization)	200 µg	61018
AS09 441	IAA Indole-3-acetic acid (C1') (5mg)	5 mg	101098
AS09 442	Cytokinin Ortho-topolin riboside (for immunolocalization)	200 µg	61018
AS09 443	Cytokinin Kinetin riboside (1 mg)	1 mg	61018
AS09 444	Cytokinin Kinetin riboside (5 mg)	5 mg (5 x 1 mg)	101098
AS09 445	IAA Indole-3-acetic acid (C1') (for immunolocalization)	200 µg	61018
AS09 446	ABA Absciscic acid (C1) (for immunolocalization)	200 µg	61018
AS09 447	Cytokinin Ortho-topolin riboside (5 mg)	5 mg	101098
AS09 449	GLUC Beta-glucosidase	10 mg	50369
AS09 450	GLUC beta-glucosidase, Biotin conjugated	1 ml	77282
AS09 451	GLUC beta-glucosidase, Affinity purified	1 mg	91224
AS09 452	Alpha-mannosidase	10 mg	50369

Cat. No.	Product Description	Pack Size	Price
AS09 453	Alpha-mannosidase, Biotin conjugated	1 ml	77282
AS09 454	GDE / AGL Glycogen debranching enzyme	200 µg	73151
AS09 455	GP Glycogen phosphorylase	50 µg	53875
AS09 455	GP Glycogen phosphorylase (2 Units)	50 µg	41483
AS09 455	GP Glycogen phosphorylase (3 Units or More)	50 µg	38730
AS09 457	AtpG ATPsynthase subunit II b' (chloroplatic)	100 µl	68505
AS09 458	PEPC Phosphoenolpyruvate carboxylase	50 µg	53875
AS09 458	PEPC Phosphoenolpyruvate carboxylase (2 Units)	50 µg	41483
AS09 458	PEPC Phosphoenolpyruvate carboxylase (3 Units or More)	50 µg	38730
AS09 458-ALP	PEPC phosphoenolpyruvate carboxylase, ALPconjugated (40 µg)	40 µg	79520
AS09 458-HRP	PEPC phosphoenolpyruvate carboxylase, HRPconjugated (40 µg)	40 µg	79520
AS09 458S	PEPC Phosphoenolpyruvate carboxylase positive control/quantitation standard	100 µl	36664
AS09 458S	PEPC Phosphoenolpyruvate carboxylase positive control/quantitation standard (2 Units)	100 µl	30640
AS09 458S	PEPC Phosphoenolpyruvate carboxylase positive control/quantitation standard (3 Units or More)	100 µl	27199
AS09 459	ClpB-P ClpB3	200 µl	66439
AS09 460	AKINB1 SNF1-related protein kinase regulatory subunit beta-1	200 µg	73151
AS09 461	PsaD PSI-D subunit of photosystem I	50 µl	68505
AS09 462	AKINB2 SNF1-related protein kinase regulatory subunit beta-2	200 µg	73151
AS09 463	AKIN β gamma	50 µg	53875
AS09 463	AKIN β gamma (2 Units)	50 µg	41483
AS09 463	AKIN β gamma (3 Units or More)	50 µg	38730
AS09 466	V-ATPase, a Vacuolar H ⁺ ATPase, subunit a	100 µl	98580
AS09 467	V-ATPase, A Vacuolar H ⁺ -ATPase subunit A (ammonium sulfate purified IgG)	100 µl	98580
AS09 468	V-ATPase, c Vacuolar H ⁺ -ATPase, subunit c (16 kDa)	50 µg	53875
AS09 468	V-ATPase, c Vacuolar H ⁺ -ATPase, subunit c (16 kDa) (2 Units)	50 µg	41483
AS09 468	V-ATPase, c Vacuolar H ⁺ -ATPase, subunit c (16 kDa) (3 Units or More)	50 µg	38730
AS09 469	PIP2;7 Plasma membrane aquaporin, N-terminal	100 µl	98580
AS09 471	PDR8 ABC transporter G family member 36	100 µl	98580
AS09 472	MRP1, ABCC1 ABC transporter C family member 1	100 µl	98580
AS09 473	NRT1.4 Nitrate transporter	100 µl	98580
AS09 475	Ligand-gated ion channel 1.3	100 µl	98580
AS09 476	AtArf2 ADP ribosylation factor 2	100 µl	98580
AS09 479	GST class-phi Glutathione S tranferase	100 µl	98580
AS09 481	BiP Lumenal-binding protein (rabbit antibody)	50 µg	53875
AS09 481	BiP Lumenal-binding protein (rabbit antibody) (2 Units)	50 µg	41483
AS09 481	BiP Lumenal-binding protein (rabbit antibody) (3 Units or More)	50 µg	38730
AS09 481-HRP	BiP Lumenal-binding protein, HRP-conjugated (40 µg)	40 µg	79520
AS09 481PRE	BiP lumenal-binding protein, pre-immune serum	100 µl	26165
AS09 482	TIP1 Tonoplast intrinsic protein 1-1	100 µl	98580
AS09 483	AtCCaP1 vacuolar calcium-binding protein-related	100 µl	98580
AS09 484	Na ⁺ /H ⁺ antiporter, sodium/hydrogen exchanger	50 µl	53875
AS09 484	Na ⁺ /H ⁺ antiporter, sodium/hydrogen exchanger (2 Units)	50 µl	41483
AS09 484	Na ⁺ /H ⁺ antiporter, sodium/hydrogen exchanger (3 Units or More)	50 µl	38730
AS09 485	MTP1 vacuolar Zn ²⁺ /H ⁺ antiporter	100 µl	98580
AS09 486	Ca ²⁺ -ATPase Calmodulin-stimulated calcium-ATPase	100 µl	98580
AS09 487	PIP (PIP1;1, PIP1;2, PIP1;3, PIP1;4, PIP1;5) Aquaporins	50 µg	53875

Cat. No.	Product Description	Pack Size	Price
AS09 487	PIP (PIP1;1, PIP1;2, PIP1;3, PIP1;4, PIP1;5) Aquaporins (2 Units)	50 µg	41483
AS09 487	PIP (PIP1;1, PIP1;2, PIP1;3, PIP1;4, PIP1;5) Aquaporins (3 Units or More)	50 µg	38730
AS09 487-ALP	PIP (PIP1;1, PIP1;2, PIP1;3, PIP1;4, PIP1;5) aquaporins, ALP-conjugated (40 µg)	40 µg	79520
AS09 487-HRP	PIP (PIP1;1, PIP1;2, PIP1;3, PIP1;4, PIP1;5) aquaporins, HRP-conjugated (40 µg)	40 µg	79520
AS09 488	PIP2;1+PIP2;2 Aquaporin PIP2;1+PIP2;2	100 µl	98580
AS09 489	PIP1;1, PIP1;2, PIP1;3 Aquaporins	100 µl	98580
AS09 490	PIP2;2 Plasma membrane aquaporin 2b	100 µl	98580
AS09 491	PIP2;1, PIP2;2, PIP2;3 Plasma membrane intrinsic protein 2-1,2-2,2-3	100 µl	98580
AS09 492	TIP1;1, TIP1;2 tonoplast intrinsic protein 1-1, 1-2 (gamma)	100 µl	98580
AS09 493	TIP1;1, TIP1;2 tonoplast intrinsic protein 1-1, 1-2 (gamma)	200 µl	85544
AS09 493P	TIP1;1, TIP1;2 tonoplast intrinsic protein 1-1, 1-2 (gamma) blocking peptide	100 µg (10 µg/µl)	22723
AS09 494	TIP2;1 (delta) Delta-VM23	100 µl	98580
AS09 495	SIP1 Small basic intrinsic protein 1-1	100 µl	98580
AS09 496	SIP2 Small basic intrinsic protein 2-1	100 µl	98580
AS09 497	V-ATPase, D Vacuolar H ⁺ -ATPase subunit D	100 µl	98580
AS09 499	V-ATPase, H vacuolar H ⁺ -ATPase subunit H	100 µl	98580
AS09 500	ICL Isocitrate lyase	100 µl	98580
AS09 501	Cat Catalase (peroxisomal marker)	50 µl	53875
AS09 501	Cat Catalase (peroxisomal marker) (2 Units)	50 µl	41483
AS09 501	Cat Catalase (peroxisomal marker) (3 Units or More)	50 µl	38730
AS09 501PRE	Cat Catalase (peroxisomal marker), pre-immune serum	100 µl	26165
AS09 502	V-ATPase, A vacuolar H ⁺ -ATPase subunit A	100 µl	98580
AS09 504	PIP1;3 Aquaporin, plasma membrane intrinsic protein 1-3	100 µl	98580
AS09 505	PIP1;3 Aquaporin, plasma membrane intrinsic protein 1-3	100 µl	98580
AS09 506	PIP2;3 Aquaporin, plasma membrane intrinsic protein 2-3	100 µl	98580
AS09 507	PIP2;1 aquaporin, plasma membrane intrinsic protein 2-1	100 µl	98580
AS09 508	PIP2;5 aquaporin, plasma membrane intrinsic protein 2-5	100 µl	98580
AS09 509	TIP2;1 tonoplast intrinsic protein 2-1	100 µl	98580
AS09 510	TIP2;2 Tonoplast intrinsic protein 2-2	100 µl	98580
AS09 511	TIP2;2 tonoplast intrinsic protein 2-2, C-terminal	100 µl	98580
AS09 512	Lhcb4 CP29 (Lhcb4) homolog (Ostreococcus tauri)	200 µl	64546
AS09 513	Lhcb5 CP26 (Lhcb5) homolog (Ostreococcus tauri)	200 µl	64546
AS09 514	HydA Iron-hydrogenase HydA1/HydA2	100 µl	68505
AS09 515	KC1 potassium channel KAT3	200 µg	73151
AS09 516	AKT1 Potassium channel AKT1	200 µg	73151
AS09 517	IAA tracer (alkaline phosphatase conjugated)	1000 assays	43204
AS09 518	Oxalate oxidase	1 mg	91224
AS09 519	Oxalate oxidase, Biotin conjugated	1 ml (10 mg/ml)	77282
AS09 520	APase acid phosphatase	1 mg	91224
AS09 521	ACO1 Aconitase	100 µl	68505
AS09 522	Lhcb1 LHCII type I chlorophyll a/b-binding protein (Arabidopsis specific)	100 µg	64546
AS09 524	MnSOD Manganese superoxide dismutase	50 µl	53875
AS09 524	MnSOD Manganese superoxide dismutase (2 Units)	50 µl	41483
AS09 524	MnSOD Manganese superoxide dismutase (3 Units or More)	50 µl	38730
AS09 527	AGO1 Argonaute 1	50 µg	53875
AS09 527	AGO1 Argonaute 1 (2 Units)	50 µg	41483

Cat. No.	Product Description	Pack Size	Price
AS09 527	AGO1 Argonaute 1 (3 Units or More)	50 µg	38730
AS09 527-ALP	AGO1 Argonaute 1 (40 µg, ALP-conjugated)	40 µg	79520
AS09 527B	AGO1 Argonaute 1 (40 µg, Biotin conjugated)	40 µg	79520
AS09 527-HRP	AGO1 Argonaute 1 (40 µg, HRP-conjugated)	40 µg	79520
AS09 527P	AGO1 Argonaute 1, Blocking peptide	100 µg	31157
AS09 530	CBP20 nuclear cap-binding protein subunit 2	200 µg	74185
AS09 531	CBP80 nuclear cap-binding protein subunit 1	200 µl	68505
AS09 532A	SE Serrate RNA effector molecule (rabbit antibody)	50 µg	53875
AS09 532A	SE Serrate RNA effector molecule (rabbit antibody) (2 Units)	50 µg	41483
AS09 532A	SE Serrate RNA effector molecule (rabbit antibody) (3 Units or More)	50 µg	38730
AS09 533	PsbS 22 kDa Lhc-like PSII protein (rabbit antibody)	50 µl	53875
AS09 533	PsbS 22 kDa Lhc-like PSII protein (rabbit antibody) (2 Units)	50 µl	41483
AS09 533	PsbS 22 kDa Lhc-like PSII protein (rabbit antibody) (3 Units or More)	50 µl	38730
AS09 534	SOD1 aa 03-20 superoxide dismutase 1, soluble	100 µl	68505
AS09 535	SOD1 aa 24-39 superoxide dismutase 1, soluble	50 µl	68505
AS09 536	SOD1 aa 43-57 superoxide dismutase 1, soluble	50 µl	68505
AS09 537	SOD1 aa 58-72 superoxide dismutase 1, soluble	50 µl	68505
AS09 538	SOD1 aa 80-96 superoxide dismutase 1, soluble	50 µl	68505
AS09 539	SOD1 aa 100-115 superoxide dismutase 1, soluble	50 µl	68505
AS09 540	SOD1 aa 131-153 superoxide dismutase 1, soluble	50 µl	68505
AS09 541	APase acid phosphatase, Biotin conjugated	1 ml (10 mg/ml)	77282
AS09 542	GLYR Glyoxylate reductase	10 mg	50369
AS09 543	GLYR glyoxylate reductase, Biotin conjugated	1 ml	77282
AS09 544	GLYR Glyoxylate reductase, Affinity purified	1 mg	91224
AS09 545	PPI papain	10 mg	50369
AS09 546	PPI papain, Biotin conjugated	1 ml	77282
AS09 547	PPI Papain (affinity purified)	1 mg	91224
AS09 549	HRP Horseradish peroxidase (affinity purified)	1 mg	91224
AS09 550	Ficain ficin	10 mg	50369
AS09 551	Ficain ficin, Biotin conjugated	1 ml	77282
AS09 552	Bromelain	10 mg	50369
AS09 553	Bromelain, Biotin conjugated	1 ml	77282
AS09 554	Bromelain (affinity purified)	1 mg	91224
AS09 556	PLD Phospholipase D	10 mg	50369
AS09 557	PLD phospholipase D, Biotin conjugated	1 ml	77282
AS09 558	PLD Phospholipase D (affinity purified)	1 mg	91224
AS09 559	Urease	10 mg	50369
AS09 560	Urease, Biotin conjugated	1 ml	77282
AS09 561	Urease, Affinity purified	1 mg	91224
AS09 562	3-hydroxybutyrate dehydrogenase	10 mg	50369
AS09 563	3-hydroxybutyrate dehydrogenase, Biotin conjugated	1 ml	77282
AS09 564	3-hydroxybutyrate dehydrogenase, Affinity purified	1 mg	91224
AS09 566	Peanut protein	100 µg	77282
AS09 568	Sesame protein	100 µl	77282
AS09 569	Soy protein	100 µg	77282
AS09 571	Wheat gluten	100 µl	77282
AS09 574	Rnr3 Ribonucleoside-diphosphate reductase large chain 2	250 µg	73151
AS09 577	V-ATPase Epsilon subunit of tonoplast H ⁺ ATPase (goat antibody)	300 µl	68505

Cat. No.	Product Description	Pack Size	Price
AS09 577A	V-ATPase epsilon subunit of tonoplast H+ATPase (affinity purified, goat antibody)	200 µg	73151
AS09 578	A set of 7 antibodies against SOD1 superoxide dismutase 1, soluble	6x 50 µl + 1x 100	390867
AS09 580	aadA1 Aminoglycoside adenytransferase (chloroplast transformation marker)	50 µg	53875
AS09 580	aadA1 Aminoglycoside adenytransferase (chloroplast transformation marker) (2 Units)	50 µg	41483
AS09 580	aadA1 Aminoglycoside adenytransferase (chloroplast transformation marker) (3 Units or More)	50 µg	38730
AS09 591	AtpH ATP synthase subunit c (chloroplastic)	100 µl	68505
AS09 592	HSP70/HSC70 Heat shock protein 70	200 µl	68505
AS09 593	Gly glycine	1 mg	91224
AS09 594	GSH Glutathione (rabbit antibody)	100 µl	91224
AS09 595	GSH Glutathione (rat antibody)	100 µl	91224
AS09 596	Melatonin (rabbit antibody)	100 µl	91224
AS09 597	Melatonin (rat antibody)	100 µl	91224
AS09 598	Ornithine	100 µl	91224
AS09 599	Spermine	100 µl	91224
AS09 600	HydA2 Iron-hydrogenase HydA2	100 µl	68505
AS09 601	c-Myc	100 µg	73151
AS09 602	Goat anti-Rabbit IgG (H&L), HRP conjugated	1 mg	37869
AS09 603	Goat anti-Chicken IgY (H&L), HRP conjugated	1 mg	38730
AS09 604	Donkey anti-Sheep IgG (H&L), HRP conjugated	1 mg	38730
AS09 605	Rabbit anti-Goat IgG (H&L), HRP conjugated	1 mg	38730
AS09 606	Goat anti-Chicken IgY (H&L), ALP conjugated	1 mg	38730
AS09 607	Goat anti-Rabbit IgG (H&L), ALP conjugated	1 mg	38730
AS09 608	Goat anti-Rabbit IgG (H&L), Biotin conjugated	2 mg	38730
AS09 610	Goat anti-Chicken IgY (H&L), Biotin conjugated	2 mg	38730
AS09 611	Donkey anti-Sheep IgG (H&L), Biotin conjugated	2 mg	38730
AS09 613	AKING1 SNF1-related protein kinase regulatory subunit gamma 1	50 µg	53875
AS09 613	AKING1 SNF1-related protein kinase regulatory subunit gamma 1 (2 Units)	50 µg	41483
AS09 613	AKING1 SNF1-related protein kinase regulatory subunit gamma 1 (3 Units or More)	50 µg	38730
AS09 614	BiP Lumenal-binding protein (chicken antibody)	100 µg	73151
AS09 615	BiP Lumenal-binding protein (goat antibody)	100 µg	73151
AS09 617	AGO4 Argonaute 4	50 µg	53875
AS09 617	AGO4 Argonaute 4 (2 Units)	50 µg	41483
AS09 617	AGO4 Argonaute 4 (3 Units or More)	50 µg	38730
AS09 617-1mg	AGO4 Argonaute 4 (1 mg)	1 mg	549037
AS09 618	Goat anti-Rat IgG (H&L), HRP conjugated, min. crossreactivity to human, mouse IgG (highly absorbed against mouse IgG)	1 mg	38730
AS09 620	Goat anti-Rat IgG (H&L), ALP conjugated	1 mg	38730
AS09 622	Goat anti-Chicken IgY (H&L), DyLight® 488 conjugated	1 mg	38730
AS09 623	Rabbit anti-Goat IgG (H&L), DyLight® 488 conjugated	1 mg	38730
AS09 627	Rabbit anti-Mouse IgG (H&L), HRP conjugated	1 mg	38730
AS09 628	Donkey anti-Sheep IgG (H&L), ALP conjugated	1 mg	38730
AS09 629	Rabbit anti-Mouse IgG (H&L), ALP conjugated	1 mg	42860
AS09 630	Rabbit anti-Goat IgG (H&L), ALP conjugated	1 mg	45097
AS09 631	Donkey anti-Sheep IgG (H&L), DyLight® 488 conjugated	1 mg	38730
AS09 632	Goat anti-Mouse IgG (H&L), DyLight® 488 conjugated	1 mg	38730
AS09 633	Goat anti-Rabbit IgG (H&L), DyLight® 488 conjugated	1 mg	38730

Cat. No.	Product Description	Pack Size	Price
AS09 634	Goat anti-Rabbit IgG (H&L), DyLight® 488 conjugated, min. cross-reactivity to bovine, human, mouse IgG or serum proteins	1 mg	38730
AS09 636	Donkey anti-Sheep IgG (H&L), DyLight® 488 conjugated, min. cross-reactivity to human or rabbit IgG	1 mg	42860
AS09 637	Goat anti-Mouse IgG (H&L), DyLight® 488 conjugated, min. cross-reactivity to human IgG or serum proteins	1 mg	38730
AS09 638	Goat anti-Rat IgG (H&L), DyLight® 488 conjugated	1 mg	38730
AS09 639	Goat anti-Rat IgG (H&L), DyLight® 488 conjugated, min. cross-reactivity to human, mouse IgG	1 mg	38730
AS09 647	GSNOR S-nitrosoglutathione reductase	50 µl	53875
AS09 647	GSNOR S-nitrosoglutathione reductase (2 Units)	50 µl	41483
AS09 647	GSNOR S-nitrosoglutathione reductase (3 Units or More)	50 µl	38730
AS09 648	Ricin (RTA subunit), clone MMA	200 µg	78445
AS09 649	Ricin (whole molecule), clone MMH	200 µg	78445
AS09 650	Alpha-mannosidase, Affinity purified	1 mg	88706
AS10 1000	Donkey anti-Sheep IgG (H&L), Affinity purified, Unconjugated	2 mg	42860
AS10 1001	Goat anti-Human IgG Fc, F(ab)'2 fragment, TRITC conjugated, min. cross-reactivity to bovine,mouse,rabbit serum	0.5 mg	45097
AS10 1002	Goat anti-Mouse IgG (H&L), F(ab)'2 fragment, FITC conjugated, min. cross-reactivity to human IgG/serum	0.5 mg	42860
AS10 1003	Rabbit anti-Goat IgG Fc, HRP conjugated	1 mg	45097
AS10 1004	Chicken anti-Mouse IgG (H&L), TRITC conjugated, min. cross-reactivity to human, rabbit IgG/serum	0.5 mg	42860
AS10 1005	Goat anti-Human IgA + IgG + IgM, FITC conjugated	2 mg	41999
AS10 1007	Donkey anti-Rat IgG (H&L), ALP conjugated	1 mg	42860
AS10 1008	Donkey anti-Rabbit IgG (H&L), HRP conjugated, min. cross-reactivity to bovine, chicken, goat, guinea pig, hamster, horse, human, mouse, rat, sheep IgG	1 mg	42860
AS10 1009	Goat anti-Human IgM (µ chain), F(ab)'2 fragment, HRP conjugated	0.5 mg	45097
AS10 1011	Goat anti-Rabbit IgG (H&L), F(ab)'2 fragment, FITC conjugated	0.5 mg	42860
AS10 1013	Goat anti-Human IgE (epsilon chain), TRITC conjugated, min. cross-reactivity to bovine,mouse,rabbit serum	1 mg	53359
AS10 1014	Donkey anti-Rabbit IgG (H&L), HRP conjugated, min. cross-reactivity to mouse IgG/serum	1 mg	42860
AS10 1015	Goat anti-Human IgG (H&L), F(ab)'2 fragment, FITC conjugated, min. cross-reactivity to bovine,mouse,rabbit serum	0.5 mg	42860
AS10 1016	Donkey anti-Rat IgG (H&L), ALP conjugated, min. crossreactivity to bovine, chicken, goat, guinea pig, hamster, horse, human, mouse, rabbit, sheep IgG	1 mg	42860
AS10 1017	Goat anti-Rabbit IgG (H&L), F(ab)'2 fragment, ALP (alkaline phosphatase) conjugated, min. cross-reactivity to bovine,human, mouse IgG/serum	0.5 mg	42860
AS10 1018	Goat anti-Rabbit IgG (H&L), F(ab)'2 fragment, TRITC conjugated	0.5 mg	42860
AS10 1019	Donkey anti-Rabbit IgG (H&L), TRITC conjugated, min. cross-reactivity to bovine, chicken, goat, guinea pig, hamster, horse, human, mouse, rat, sheep IgG	1 mg	42860
AS10 1020	Goat anti-Mouse IgG Fc, Biotin conjugated	2 mg	45097
AS10 1021	Donkey anti-Goat IgG (H&L), Affinity purified, Unconjugated, min. cross-reactivity to human, mouse, rabbit, rat IgG	1 mg	42860
AS10 1022	Goat anti-Rat IgG (H&L), Affinity purified, Unconjugated, min. cross-reactivity to human, mouse IgG	2 mg	42860
AS10 1023	Goat anti-Rat IgG (H&L), F(ab)'2 fragment, Biotin conjugated, min. cross-reactivity to human, mouse IgG	0.5 mg	45097

Cat. No.	Product Description	Pack Size	Price
AS10 1024	Donkey anti-Sheep IgG (H&L), FITC conjugated, min. cross-reactivity to human, mouse,rabbit IgG	1 mg	42860
AS10 1026	Chicken anti-Goat IgG (H&L), Biotin conjugated, min. cross-reactivity to human, mouse,rabbit IgG/serum	0.5 mg	42860
AS10 1027	Donkey anti-Mouse IgG (H&L), ALP conjugated	1 mg	42860
AS10 1028	Chicken anti-Rat IgG (H&L), Affinity purified, Unconjugated, min. cross-reactivity to human, rabbit, IgG/serum	1 mg	42860
AS10 1029	Goat anti-Human IgM (μ chain), F(ab)'2 fragment, Affinity purified, Unconjugated	1 mg	45097
AS10 1030	Goat anti-Rabbit IgG (H&L), FITC conjugated, min. cross-reactivity to bovine,human, mouse IgG/serum	2 mg	42860
AS10 1033	Chicken anti-Mouse IgG (H&L), HRP conjugated	1 mg	42860
AS10 1034	Chicken anti-Goat IgG (H&L), Affinity purified, Unconjugated, min. cross-reactivity to human, mouse, rabbit IgG/serum	1 mg	42860
AS10 1035	Goat anti-Human IgM (μ chain), HRP conjugated	1 mg	42860
AS10 1036	Rabbit anti-Mouse IgG (H&L), TRITC conjugated, min.cross-reactivity to human serum	2 mg	42860
AS10 1039	Goat anti-Human IgG + IgA + IgM, F(ab)'2 fragment, HRP conjugated	0.5 mg	45097
AS10 1040	Goat anti-Rat IgG (H&L), FITC conjugated, min.reactivity to human, mouse IgG	2 mg	45097
AS10 1042	Goat anti-Rabbit IgG (H&L), F(ab)'2 fragment, FITC conjugated, min. cross-reactivity to bovin, human, mouse IgG/serum	0.5 mg	42860
AS10 1043	Donkey anti-Goat IgG (H&L), ALP conjugated, min. cross-reactivity to human, mouse, rabbit, rat IgG	0.5 mg	42860
AS10 1045	Rabbit anti-Goat IgG (H&L), F(ab)'2 fragment, HRP conjugated	0.5 mg	45097
AS10 1046	Donkey anti-Goat IgG (H&L), TRITC conjugated	1 mg	42860
AS10 1047	Donkey anti-Rabbit IgG (H&L), FITC conjugated, min. cross-reactivity to mouse IgG/serum	2 mg	42860
AS10 1048	Goat anti-Guinea pig IgG (H&L), TRITC conjugated, min.reactivity to bovine,chicken,goat,hamster,horse,human, mouse, rabbit, rat,Sheep serum	1 mg	42860
AS10 1049	Goat anti-Mouse IgG (H&L), TRITC conjugated, min. cross-reactivity tohuman IgG/serum	1 mg	42860
AS10 1053	Goat anti-Guinea pig IgG (H&L), Affinity purified, Unconjugated, min. cross-reactivity to bovine, chicken, goat, hamster, horse, human, mouse, rabbit, rat, sheep serum	1 mg	42860
AS10 1055	Goat anti-Rabbit IgG (H&L), Biotin conjugated, min. cross-reactivity to bovine,goat,human, mouse,rat IgG	1 mg	42860
AS10 1057	Goat anti-Human IgG Fc, TRITC conjugated, min. crossreactivity to human IgA+IgM	2 mg	42860
AS10 1058	Rabbit anti-Goat IgG (H&L), F(ab)'2 fragment, FITC conjugated, min. cross-reactivity to human, mouse,Rat IgG	0.5 mg	45097
AS10 1059	Goat anti-Rabbit IgG (H&L), F(ab)'2 fragment, TRITC conjugated, min. cross-reactivity to bovine,human, mouse IgG/serum	0.5 mg	42860
AS10 1061	Rabbit anti-Goat IgG (H&L), Affinity purified, Unconjugated, min. cross-reactivity human, mouse,Rat IgG	1 mg (9.68 mg/ml)	42860
AS10 1062	Donkey anti-Goat IgG (H&L), Affinity purified, Unconjugated	2 mg	42860
AS10 1063	Chicken anti-Rabbit IgG (H&L), TRITC conjugated	1 mg	42860
AS10 1065	Rabbit anti-Goat IgG (H&L), F(ab)'2 fragment, HRP conjugated, min. cross-reactivity to human, mouse,Rat IgG	0.5 mg	45097
AS10 1066	Goat anti-Mouse IgG (H&L), ALP conjugated, min. crossreactivity to human IgG/serum	1 mg	45097
AS10 1068	Chicken anti-Goat IgG (H&L), HRP conjugated	1 mg	42860

Cat. No.	Product Description	Pack Size	Price
AS10 1069	Donkey anti-Goat IgG (H&L), HRP conjugated, min. cross-reactivity to human, mouse, rabbit, rat IgG	1 mg (1.0 mg/ml)	42860
As10 1071	Goat anti-Mouse IgG (H&L), F(ab)'2 fragment, TRITC conjugated, min. cross-reactivity to human IgG/serum	0.5 mg	42860
AS10 1075	Goat anti-Rat IgG (H&L), ALP conjugated, min. crossreactivity to human, mouse IgG	1 mg	45097
AS10 1076	Goat anti-Human IgA (alpha chain), F(ab)'2 fragment, FITC conjugated	0.5 mg	43893
AS10 1077	Rabbit anti-Goat IgG (H&L), F(ab)'2 fragment, Affinity purified, Unconjugated, min. cross-reactivity to human, mouse,Rat IgG	1 mg	45097
AS10 1078	Donkey anti-Goat IgG (H&L), FITC conjugated	2 mg	42860
AS10 1079	Donkey anti-Rabbit IgG (H&L), DyLight® 488 conjugated, min. cross-reactivity to human IgG and serum proteins	1 mg	38730
AS10 1080	Goat anti-Guinea pig IgG (H&L), DyLight® 488 conjugated, min. cross-reactivity to bovine, chicken, goat, hamster, horse, human, mouse, rabbit, rat, sheep Serum	1 mg	45097
AS10 1081	Goat anti-Mouse IgG (H&L), F(ab)'2 fragment, Biotin conjugated	0.5 mg	42860
AS10 1082	Donkey anti-Mouse IgG (H&L), Affinity purified, Unconjugated, min. cross-reactivity to bovine,chicken, goat, guinea pig, hamster, horse, human, rabbit, rat or sheep IgG	2 mg	42860
AS10 1083	Donkey anti-Rabbit IgG (H&L), Biotin conjugated, min. cross-reactivity to bovine, chicken, goat, guinea pig, hamster, horse, human, mouse, rat, sheep IgG	2 mg	42860
AS10 1084	Goat anti-Human IgG Fc, FITC conjugated, min. crossreactivity to bovine,mouse,rabbit serum	2 mg	42860
AS10 1086	Goat anti-Rabbit IgG (H&L), ALP conjugated, min. crossreactivity to bovine,goat,human, mouse,rat IgG	1 mg	45097
AS10 1087	Donkey anti-Mouse IgG (H&L), HRP conjugated, min. cross-reactivity to bovine,chicken, goat, guinea pig, hamster, horse, human, rabbit, rat or sheep IgG	1 mg	42860
AS10 1088	Goat anti-Rat IgG (H&L), F(ab)'2 fragment, TRITC conjugated, min. cross-reactivity to human, mouse IgG	0.5 mg	45097
AS10 1089	Goat anti-Human IgG (H&L), TRITC conjugated	2 mg	42860
AS10 1090	Goat anti-Human IgM (μ chain), F(ab)'2 fragment, TRITC conjugated, min. cross-reactivity to human IgG or IgA	0.5 mg	42860
AS10 1091	Goat anti-Human IgA (alpha chain), FITC conjugated	1 mg	42860
AS10 1092	Donkey anti-Goat IgG (H&L), FITC conjugated, min. cross-reactivity to human, mouse, rabbit, rat IgG	1 mg	42860
AS10 1093	Donkey anti-Rat IgG (H&L), Biotin conjugated, min. cross-reactivity to bovine, chicken, goat, guinea pig, hamster, horse, human, mouse, rabbit, sheep IgG	1 mg	49228
AS10 1094	Goat anti-Rat IgG (H&L), HRP conjugated, min. crossreactivity to human, mouse IgG	1 mg	42860
AS10 1095	Goat anti-Mouse IgG (H&L), Biotin conjugated	2 mg	42860
AS10 1096	Goat anti-Mouse IgG (H&L), DyLight® 488 conjugated, min. cross-reactivity to bovine, goat, human, rabbit, rat IgG	1 mg	40795
AS10 1097	Goat anti-Human IgA (alpha chain), F(ab)'2 fragment, TRITC conjugated	0.5 mg	42860
AS10 1098	Donkey anti-Sheep IgG (H&L), TRITC conjugated	1 mg	38730
AS10 1099	Goat anti-Human IgG Fc, F(ab)'2 fragment, FITC conjugated, min. cross-reactivity to bovine,mouse,rabbit serum	0.5 mg	45097
AS10 1100	Rabbit anti-Goat IgG Fc, TRITC conjugated	1 mg	45097
AS10 1101	Rabbit anti-Goat IgG (H&L), TRITC conjugated, min. cross-reactivity to human, mouse,Rat IgG	1 mg	42860

Cat. No.	Product Description	Pack Size	Price
AS10 1102	Donkey anti-Rat IgG (H&L), TRITC conjugated	2 mg	42860
AS10 1103	Chicken anti-Mouse IgG (H&L), Biotin conjugated, min. cross-reactivity to human, rabbit IgG/serum	0.5 mg	42860
AS10 1104	Goat anti-Chicken IgY (H&L), TRITC conjugated	2 mg	42860
AS10 1105	Goat anti-Human IgG (H&L), FITC conjugated, min. cross-reactivity to bovine,mouse,rabbit serum	2 mg	42860
AS10 1106	Rabbit anti-Goat IgG Fc, HRP conjugated, min. crossreactivity to human serum	1 mg	45097
AS10 1107	Chicken anti-Rat IgG (H&L), HRP conjugated, min. cross-reactivity to human, rabbit IgG/serum	0.5 mg	42860
AS10 1108	Goat anti-Rat IgG (H&L), Affinity purified, Unconjugated, min. cross-reactivity to human, mouse IgG	1 mg	42860
AS10 1110	Donkey anti-Mouse IgG (H&L), ALP conjugated, min. cross-reactivity to bovine,chicken, goat, guinea pig, hamster, horse, human, rabbit, rat or sheep IgG	1 mg	42860
AS10 1112	Chicken anti-Goat IgG (H&L), ALP conjugated	1 mg	42860
AS10 1113	Rabbit anti-Mouse IgG (H&L), Affinity purified, Unconjugated, min. cross-reactivity to human serum	2 mg	42860
AS10 1114	Rabbit anti-Mouse IgG (H&L), HRP conjugated, min. cross-reactivity to human serum	1 mg	42860
AS10 1115	Donkey anti-Rat IgG (H&L), HRP conjugated, min. crossreactivity to bovine, chicken, goat, guinea pig, hamster, horse, human, mouse, rabbit, sheep IgG	1 mg	42860
AS10 1116	Donkey anti-Goat IgG (H&L), DyLight® 488 conjugated	1 mg	38730
AS10 1117	Goat anti-Guinea pig IgG (H&L), FITC conjugated, min. cross-reactivity to bovine,chicken,goat,hamster,horse,human, mouse, rabbit, rat,Sheep serum	1 mg	42860
AS10 1118	Goat anti-Mouse IgG (H&L), TRITC conjugated, min. cross-reactivity to goat,human, rabbit, rat IgG	1 mg	42860
AS10 1119	Donkey anti-Rabbit IgG (H&L), Affinity purified, Unconjugated, min. cross-reactivity to bovine, chicken, goat, guinea pig, hamster, horse, human, mouse, rat, sheep IgG	2 mg	42860
AS10 111S	CP43' IsiA homolog of plant CP43 positive control/quantitation standard	250 µl	49228
AS10 1121	Goat anti-Rabbit IgG (H&L), FITC conjugated, min. cross-reactivity to bovine,goat,human, mouse,rat IgG	1 mg	42860
AS10 1123	Goat anti-Human IgA (alpha chain), TRITC conjugated, min. cross-reactivity to bovine,mouse,rabbit serum	1 mg	42860
AS10 1124	Goat anti-Human IgG (H&L), FITC conjugated	2 mg	42860
AS10 1125	Chicken anti-Mouse IgG (H&L), ALP conjugated	1 mg	42860
AS10 1126	Goat anti-Human IgM (µ chain), HRP conjugated, min. cross-reactivity to human IgA or IgG	1 mg	42860
AS10 1127	Donkey anti-Rabbit IgG (H&L), ALP conjugated, min. cross-reactivity to bovine, chicken, goat, guinea pig, hamster, horse, human, mouse, rat, sheep IgG	1 mg	42860
AS10 1132	Goat anti-Rat IgG (H&L), Affinity purified, Unconjugated	2 mg	42860
AS10 1133	Chicken anti-Goat IgG (H&L), Affinity purified, Unconjugated	2 mg	42860
AS10 1134	Donkey anti-Sheep IgG (H&L), TRITC conjugated, min. cross-reactivity to human, mouse,rabbit IgG	1 mg	42860
AS10 1135	Goat anti-Human IgM (µ chain), FITC conjugated, min. cross-reactivity to human IgA or IgG	1 mg	42860
AS10 1136	Goat anti-Rat IgG (H&L), FITC conjugated	2 mg	42860
AS10 1137	Chicken anti-Goat IgG (H&L), TRITC conjugated	1 mg	42860

Cat. No.	Product Description	Pack Size	Price
AS10 1138	Donkey anti-Rat IgG (H&L), FITC conjugated	2 mg	42860
AS10 1139	Goat anti-Mouse IgG (H&L), F(ab)'2 fragment, ALP conjugated	0.5 mg	42860
AS10 1140	Goat anti-Human IgA (alpha chain), TRITC conjugated	1 mg	42860
AS10 1141	Goat anti-Human IgA + IgG + IgM, Affinity purified, Unconjugated	2 mg	42860
AS10 1142	Chicken anti-Rabbit IgG (H&L), FITC conjugated, min. cross-reactivity to human, mouse IgG	0.5 mg	42860
AS10 1143	Rabbit anti-Goat IgG Fc, Biotin conjugated, min. crossreactivity to human serum	1 mg	45097
AS10 1144	Donkey anti-Rabbit IgG (H&L), TRITC conjugated, min. cross-reactivity to mouse IgG/serum	2 mg	42860
AS10 1145	Goat anti-Rat IgG (H&L), F(ab)'2 fragment, HRP conjugated, min.reactivity to human, mouse IgG	0.5 mg	45097
AS10 1146	Goat anti-Rabbit IgG (H&L), F(ab)'2 fragment, HRP conjugated, min. cross-reactivity to bovine,human, mouse IgG/serum	0.5 mg	42860
AS10 1147	Donkey anti-Sheep IgG (H&L), Biotin conjugated, min. cross-reactivity to human, rabbit IgG	2 mg	42860
AS10 1148	Donkey anti-Sheep IgG (H&L), FITC conjugated, min. cross-reactivity to human, rabbit IgG	2 mg	43893
AS10 1149	Rabbit anti-Mouse IgG (H&L), FITC conjugated	2 mg	45097
AS10 1150	Goat anti-Human IgE (epsilon chain), TRITC conjugated	1 mg	42860
AS10 1151	Goat anti-Human IgA + IgG + IgM, TRITC conjugated	2 mg	42860
AS10 1152	Goat anti-Rat IgG (H&L), TRITC conjugated, min. crossreactivity to human, mouse IgG	1 mg	45097
AS10 1153	Goat anti-Rabbit IgG (H&L), F(ab)'2 fragment, Biotin conjugated, min. cross-reactivity to bovine,human, mouse IgG/serum	0.5 mg	42860
AS10 1155	Rabbit anti-Goat IgG (H&L), FITC conjugated	2 mg	45097
AS10 1156	Goat anti-Mouse IgG (H&L), FITC conjugated, min. cross-reactivity to bovine,human, rabbit, rat IgG	1 mg	42860
AS10 1157	Goat anti-Human IgG (H&L), F(ab)'2 fragment, TRITC conjugated, min. cross-reactivity to bovine,mouse,rabbit serum	0.5 mg	42860
AS10 1159	Goat anti-Mouse IgG (H&L), ALP conjugated	1 mg	42860
AS10 1160	Donkey anti-Sheep IgG (H&L), HRP conjugated, min. cross-reactivity to human, rabbit IgG	1 mg	42860
AS10 1161	Chicken anti-Goat IgG (H&L), FITC conjugated	1 mg	42860
AS10 1162	Goat anti-mouse IgM (μ chain), Affinity purified, Unconjugated	2 mg	38730
AS10 1163	Goat anti-Mouse IgG (H&L), F(ab)'2 fragment, Affinity purified, Unconjugated	1 mg	42860
AS10 1165	Donkey anti-Rabbit IgG (H&L), DyLight® 488 conjugated, min. cross-reactivity to bovine, chicken, goat, guinea pig, hamster, horse, human, mouse, rat, sheep IgG	1 mg	45097
AS10 1167	Chicken anti-Mouse IgG (H&L), HRP conjugated, min. cross-reactivity to human, rabbit IgG/serum	0.5 mg	42860
AS10 1168	Donkey anti-Rabbit IgG (H&L), FITC conjugated, min. cross-reactivity to bovine, chicken, goat, guinea pig, hamster, horse, human, mouse, rat, sheep IgG	2 mg	42860
AS10 1171	Donkey anti-Sheep IgG (H&L), FITC conjugated	2 mg	42860
AS10 1172	Goat anti-Bovine IgG (H&L), DyLight® 488 conjugated	1 mg	38730
AS10 1174	Goat anti-Human IgM (μ chain), FITC conjugated	1 mg	42860
AS10 1176	Goat anti-Rabbit IgG (H&L), FITC conjugated	2 mg	42860
AS10 1177	Donkey anti-Mouse IgG (H&L), FITC conjugated, min. cross-reactivity to bovine,chicken, goat, guinea pig, hamster, horse, human, rabbit, rat or sheep IgG	1 mg	42860

Cat. No.	Product Description	Pack Size	Price
AS10 1178	Donkey anti-Rat IgG (H&L), TRITC conjugated, min. cross-reactivity to bovine, chicken, goat, guinea pig, hamster, horse, human, mouse, rabbit, sheep IgG	1 mg	42860
AS10 1179	Donkey anti-Sheep IgG (H&L), ALP conjugated, min. cross-reactivity to human, mouse, rabbit IgG	1 mg	43893
AS10 1180	Chicken anti-Goat IgG (H&L), Biotin conjugated	1 mg	42860
AS10 1181	Donkey anti-Goat IgG (H&L), ALP conjugated	1 mg	42860
AS10 1184	Goat anti-Human IgA + IgG + IgM, F(ab)'2 fragment, Affinity purified, Unconjugated	1 mg	42860
AS10 1187	Goat anti-Rat IgG (H&L), HRP conjugated	1 mg	42860
AS10 1189	Goat anti-Mouse IgG (H&L), F(ab)'2 fragment, HRP conjugated, min. cross-reactivity to human IgG/serum	0.5 mg	42860
AS10 1190	Rabbit anti-Mouse IgG (H&L), FITC conjugated, min. cross-reactivity to human serum	2 mg	45097
AS10 1191	Goat anti-Mouse IgG (H&L), Affinity purified, Unconjugated, min. cross-reactivity to human IgG/serum	2 mg	42860
AS10 1193	Goat anti-Mouse IgG (H&L), F(ab)'2 fragment, ALP conjugated, min. cross-reactivity to human IgG/serum	0.5 mg	45097
AS10 1195	Donkey anti-Sheep IgG (H&L), ALP conjugated, min. cross-reactivity to human, rabbit IgG	1 mg	42860
AS10 1196	Goat anti-Rabbit IgG (H&L), TRITC conjugated	1 mg	42860
AS10 1197	Goat anti-Human IgG Fc, TRITC conjugated	1 mg	42860
AS10 1198	Donkey anti-Goat IgG (H&L), DyLight® 488 conjugated, min. cross-reactivity to human, mouse, rabbit or rat IgG	1 mg	42860
AS10 1200	Goat anti-Human IgM (μ chain), F(ab)'2 fragment, Biotin conjugated	0.5 mg	45097
AS10 1201	Donkey anti-Mouse IgG (H&L), DyLight® 488 conjugated, min. cross-reactivity to bovine, chicken, goat, guinea pig, hamster, horse, human, rabbit, rat or sheep IgG	1 mg	45097
AS10 1204	Goat anti-Rabbit IgG (H&L), Biotin conjugated, min. cross-reactivity to bovine, human, mouse IgG/serum	2 mg	42860
AS10 1205	Goat anti-Mouse IgG (H&L), Affinity purified, Unconjugated, min. cross-reactivity to bovine, goat, human, rabbit, rat IgG	2 mg	42860
AS10 1206	Goat anti-Rat IgG (H&L), F(ab)'2 fragment, ALP conjugated, min. cross-reactivity to human, mouse IgG	0.5 mg	45097
AS10 1207	Goat anti-Mouse IgG (H&L), TRITC conjugated	1 mg	42860
AS10 1208	Rabbit anti-Hamster IgG (H&L), TRITC conjugated	2 mg	45097
AS10 1210	Goat anti-Rat IgG (H&L), Biotin conjugated	2 mg	42860
AS10 1211	Goat anti-Rat IgG (H&L), Biotin conjugated, min. crossreactivity to human, mouse IgG	2 mg	45097
AS10 1212	Donkey anti-Goat IgG (H&L), Biotin conjugated, min. cross-reactivity to human, mouse, rabbit, rat IgG	1 mg	42860
AS10 1214	Donkey anti-Rat IgG (H&L), Affinity purified, Unconjugated, min. cross-reactivity to bovine, chicken, goat, guinea pig, hamster, horse, human, mouse, rabbit, sheep IgG	2 mg	42860
AS10 1215	Goat anti-Rat IgG (H&L), F(ab)'2 fragment, Affinity purified, Unconjugated, min. cross-reactivity to human, mouse IgG	1 mg	42860
AS10 1216	Goat anti-Rabbit IgG (H&L), DyLight® 488 conjugated, min. cross-reactivity to bovine, goat, human, mouse, rat IgG or serum proteins	1 mg	42860
AS10 1217	Goat anti-Rat IgG (H&L), F(ab)'2 fragment, DyLight® 488 conjugated, min. cross-reactivity to human, mouse IgG	0.5 mg	46991
AS10 1218	Donkey anti-Rat IgG (H&L), Affinity purified, Unconjugated	2 mg	42860
AS10 1220	Goat anti-Mouse IgG (H&L), F(ab)'2 fragment, DyLight® 488 conjugated	0.5 mg	38730

Cat. No.	Product Description	Pack Size	Price
AS10 1221	Goat anti-Guinea pig IgG (H&L), TRITC conjugated	1 mg	42860
AS10 1222	Goat anti-Human IgA + IgG + IgM, F(ab)'2 fragment, ALP conjugated	0.5 mg	42860
AS10 1223	Goat anti-Mouse IgG (H&L), FITC conjugated	2 mg	42860
AS10 1224	Chicken anti-Rat IgG (H&L), HRP conjugated	1 mg	42860
AS10 1225	Donkey anti-Mouse IgG (H&L), Biotin conjugated	2 mg	42860
AS10 1226	Donkey anti-Sheep IgG (H&L), TRITC conjugated, min. cross-reactivity to human, rabbit IgG	2 mg	43893
AS10 1227	Goat anti-Mouse IgG Fc, HRP conjugated	1 mg	42860
AS10 1228	Donkey anti-Goat IgG (H&L), TRITC conjugated, min. cross-reactivity to human, mouse, rabbit, rat IgG	1 mg	42860
AS10 1229	Goat anti-Rabbit IgG (H&L), TRITC conjugated, min. cross-reactivity to bovine, human, mouse IgG/serum	1 mg	42860
AS10 1230	Goat anti-Rabbit IgG Fc, FITC conjugated	2 mg	42860
AS10 1231	Chicken anti-Rat IgG (H&L), Affinity purified, Unconjugated	2 mg	42860
AS10 1232	Goat anti-Rabbit IgG (H&L), F(ab)'2 fragment, Affinity purified, Unconjugated	1 mg	42860
AS10 1233	Goat anti-Rabbit IgG (H&L), Affinity purified, Unconjugated, min. cross-reactivity to bovine, human, mouse IgG/serum	2 mg	42860
AS10 1234	Goat anti-Rat IgG (H&L), F(ab)'2 fragment, FITC conjugated, min. cross-reactivity to human, mouse IgG	0.5 mg	45097
AS10 1235	Rabbit anti-Mouse IgG (H&L), ALP conjugated, min. cross-reactivity to human serum	1 mg	45097
AS10 1236	Goat anti-Human IgG Fc, F(ab)'2 fragment, FITC conjugated	0.5 mg	42860
AS10 1237	Goat anti-Human IgM (μ chain), F(ab)'2 fragment, ALP conjugated	0.5 mg	45097
AS10 1238	Chicken anti-Goat IgG (H&L), HRP conjugated, min. cross-reactivity to human, mouse, rabbit IgG/serum	0.5 mg	42860
AS10 1239	Goat anti-Human IgM (μ chain), Biotin conjugated, min. cross-reactivity to human IgA or IgG	1 mg	42860
AS10 1241	Rabbit anti-Goat IgG Fc, Biotin conjugated	1 mg	42860
AS10 1242	Donkey anti-Mouse IgG (H&L), Biotin conjugated, min. cross-reactivity to bovine, chicken, goat, guinea pig, hamster, horse, human, rabbit, rat or sheep IgG	1 mg	42860
AS10 1244	Chicken anti-Goat IgG (H&L), TRITC conjugated, min. cross-reactivity to human, mouse, rabbit IgG/serum	0.5 mg	42860
AS10 1253	Goat anti-Human IgA + IgG + IgM, F(ab)'2 fragment, Biotin conjugated	0.5 mg	42860
AS10 1254	Rabbit anti-Goat IgG Fc, ALP conjugated	0.5 mg	42860
AS10 1255	Donkey anti-Mouse IgG (H&L), Affinity purified, Unconjugated	2 mg	38730
AS10 1256	Goat anti-Human IgG (H&L), TRITC conjugated, min. cross-reactivity to bovine, mouse, rabbit serum	2 mg	42860
AS10 1257	Donkey anti-Sheep IgG (H&L), DyLight® 488 conjugated, min. cross-reactivity to human, mouse, or rabbit IgG	1 mg	45097
AS10 1258	Donkey anti-Rat IgG (H&L), Biotin conjugated	2 mg	42860
AS10 1259	Chicken anti-Goat IgG (H&L), FITC conjugated, min. cross-reactivity to human, mouse, rabbit IgG/serum	0.5 mg	42860
AS10 1260	Donkey anti-Goat IgG (H&L), HRP conjugated	1 mg	42860
AS10 1261	Donkey anti-Mouse IgG (H&L), DyLight® 488 conjugated	1 mg	38730
AS10 1263	Chicken anti-Goat IgG (H&L), ALP conjugated, min. cross-reactivity to human, mouse, rabbit IgG/serum	0.5 mg	42860
AS10 1264	Donkey anti-Rabbit IgG (H&L), Unconjugated, min. cross-reactivity to mouse IgG/serum, Affinity purified, Unconjugated	2 mg	42860
AS10 1265	Rabbit anti-Goat IgG (H&L), Affinity purified, Unconjugated	2 mg	42860

Cat. No.	Product Description	Pack Size	Price
AS10 1266	Goat anti-Rat IgG (H&L), TRITC conjugated	1 mg	42860
AS10 1267	Chicken anti-Rabbit IgG (H&L), TRITC conjugated, min. cross-reactivity to human, mouse IgG	0.5 mg	42860
AS10 1268	Goat anti-Guinea pig IgG (H&L), Biotin conjugated, min. cross-reactivity to bovine, chicken, goat, hamster, horse, human, mouse, rabbit, rat, Sheep serum	1 mg	42860
AS10 1269	Donkey anti-Rabbit IgG (H&L), TRITC conjugated	1 mg	36837
AS10 1271	Rabbit anti-Goat IgG (H&L), FITC conjugated, min. cross-reactivity to human, mouse, Rat IgG	1 mg	42860
AS10 1272	Goat anti-Rabbit IgG (H&L), ALP conjugated, min. crossreactivity to bovine, human, mouse IgG/serum	1 mg	42860
AS10 1273	Goat anti-Mouse IgG Fc, FITC conjugated	2 mg	42860
AS10 1274	Rabbit anti-Goat IgG Fc, Affinity purified, Unconjugated, min. cross-reactivity to human serum	1 mg	42860
AS10 1275	Goat anti-Human IgA + IgG + IgM, F(ab)'2 fragment, FITC conjugated	0.5 mg	42860
AS10 1277	Donkey anti-Mouse IgG (H&L), HRP conjugated	1 mg	42860
AS10 1278	Chicken anti-Rat IgG (H&L), ALP conjugated, min. crossreactivity to human, rabbit IgG/serum	0.5 mg	42860
AS10 1281	Rabbit anti-Goat IgG Fc, ALP conjugated, min crossreactivity to human serum	0.5 mg	45097
AS10 1282	Donkey anti-Rat IgG (H&L), FITC conjugated, min. crossreactivity to bovine, chicken, goat, guinea pig, hamster, horse, human, mouse, rabbit, sheep IgG	1 mg	42860
AS10 1283	Chicken anti-Rat IgG (H&L), Biotin conjugated, min. cross-reactivity to human, rabbit IgG/serum	0.5 mg	42860
AS10 1284	Goat anti-Chicken IgY (H&L), FITC conjugated	2 mg	42860
AS10 1285	Donkey anti-Mouse IgG (H&L), FITC conjugated	2 mg	42860
AS10 1286	Goat anti-Human IgA + IgG + IgM, ALP conjugated	1 mg	42860
AS10 1287	Goat anti-Human IgM (μ chain), F(ab)'2 fragment, FITC conjugated, min. cross-reactivity to human IgG or IgA	0.5 mg	46991
AS10 1288	Goat anti-Mouse IgG (H&L), Affinity purified, Unconjugated, min. cross-reactivity to bovine, goat, human, rabbit or rat IgG, hihgly adsorbed against Rat IgG	2 mg	45097
AS10 1289	Goat anti-Mouse IgG (H&L), F(ab)'2 fragment, TRITC conjugated	0.5 mg	42860
AS10 1290	Goat anti-Human IgM (μ chain), TRITC conjugated	1 mg	42860
AS10 1291	Rabbit anti-Mouse IgG (H&L), Biotin conjugated, min. cross-reactivity to human serum	2 mg	42860
AS10 1292	Donkey anti-Sheep IgG (H&L), Affinity purified, Unconjugated, min. cross-reactivity to human, mouse, rabbit IgG	2 mg	42860
AS10 1293	Donkey anti-Sheep IgG (H&L), Affinity purified, Unconjugated, min. cross-reactivity to human, rabbit IgG	2 mg	42860
AS10 1294	Goat anti-Mouse IgG Fc, ALP conjugated	1 mg	42860
AS10 1295	Goat anti-Human IgG (H&L), F(ab)'2 fragment, FITC conjugated	0.5 mg	42860
AS10 1296	Goat anti-Human IgM (μ chain), F(ab)'2 fragment, Affinity purified, Unconjugated, min. cross-reactivity to human IgA+IgG	1 mg	42860
AS10 1298	Goat anti-Human IgM (μ chain), F(ab)'2 fragment, ALP conjugated, min. cross-reactivity to human IgG or IgA	0.5 mg	49228
AS10 1299	Donkey anti-Rabbit IgG (H&L), FITC conjugated	2 mg	42860
AS10 1304	Goat anti-Human IgE (epsilon chain), FITC conjugated	1 mg	42860
AS10 1305	Donkey anti-Goat IgG (H&L), Biotin conjugated	2 mg	42860
AS10 1306	Goat anti-Human IgA + IgG + IgM, F(ab)'2 fragment, TRITC conjugated	0.5 mg	42860

Cat. No.	Product Description	Pack Size	Price
AS10 1307	TSH (beta) thyroid stimulating hormone receptor (affinity purified, goat antibody)	1 mg	90190
AS10 1309	APOE apolipoprotein E	1 mg	90190
AS10 1312	Hp Haptoglobin	1 mg	90190
AS10 1314	C1-inh C1 Inhibitor	1 mg	90190
AS10 1316	Ferritin	0.5 mg	90190
AS10 1317	Alpha-1-antichymotrypsin	1 mg	90190
AS10 1318	CKMM creatine kinase M-type	1 mg	90190
AS10 1320	Factor B (C3 Proactivator) (goat antibody)	1 mg	90190
AS10 1325	TSH (beta) thyroid stimulating hormone receptor (Affinity purified, F(ab)2' fragment, goat antibody)	0.5 mg	90190
AS10 1326	Prealbumin TTR transthyretin	1 mg	69365
AS10 1333	Cystatin C	1 mg	90190
AS10 1337	Fibrinogen unconjugated antibody	1 mg	90190
AS10 1338	Mb myoglobin (cardiac)	1 mg	79520
AS10 1340	Factor B (C3 Proactivator) (sheep antibody)	1 mg	90190
AS10 1341	TSH (alpha) (and alpha subunit of HCG, LH, TSH and FSH)	1 mg	90190
AS10 1345	AT antithrombin III	1 mg	90190
AS10 1349	TSH (intact) thyrodi stimulating hormone receptor	0.5 mg	90190
AS10 1352	PSA prostate specific antigen (goat antibody)	1 mg	90190
AS10 1353	A-I apolipoprotein A1	1 mg	90190
AS10 1354	B2M beta-2-microglobulin	1 mg	90190
AS10 1356	Factor H (B1H Globulin) (goat antibody)	1 mg	90190
AS10 1357	A1At alpha-1-antitrypsin	1 mg	90190
AS10 1359	APOB apolipoprotein B	1 mg	90190
AS10 1361	TSH (beta) thyroid stimulating hormone receptor (affinity purified, sheep antibody)	1 mg	90190
AS10 1366	Factor H (B1H Globulin) (sheep antibody)	1 mg	90190
AS10 1367	AHSG alpha-2-HS glycoprotein	1 mg	90190
AS10 1370	TF transferrin (goat antibody)	1 mg	90190
AS10 1378	AFP alpha-fetoprotein	1 mg	90190
AS10 1384	Albumin (human)	1 mg	90190
AS10 1388	HPX hemopexin	1 mg	90190
AS10 1391	APOA2 apolipoprotein A-II	1 mg	90190
AS10 1393	Plasminogen	1 mg	90190
AS10 1399	Alpha 1-antichymotrypsin	1 mg	90190
AS10 1400	Human IgM Myeloma, purified (1mg)	1 mg	34427
AS10 1402	Goat anti-Human kappa chain, Affinity purified, Unconjugated	1 mg	40795
AS10 1403	Goat anti-Human kappa chain, ALP conjugated	0.5 mg	45097
AS10 1404	Goat anti-Human kappa chain, Biotin conjugated	0.5 mg	45097
AS10 1405	Goat anti-Human kappa chain, FITC conjugated	0.5 mg	42860
AS10 1406	Goat anti-Human kappa chain, HRP conjugated	0.5 mg	42860
AS10 1407	Goat anti-Human kappa chain, TRITC conjugated	0.5 mg	42860
AS10 1409	Goat anti-Human kappa chain, Affinity purified, Unconjugated, min. cross-reactivity to Mouse serum	1 mg	42860
AS10 1411	Goat anti-Human kappa chain, Biotin conjugated, min. cross-reactivity to Mouse serum	0.5 mg	49228
AS10 1412	Goat anti-Human kappa chain, FITC conjugated, min. cross-reactivity to Mouse serum	0.5 mg	49228
AS10 1413	Goat anti-Human kappa chain, HRP conjugated, min. cross-reactivity to Mouse serum	0.5 mg	49228
AS10 1416	Goat anti-Llama IgG (H&L), Affinity purified, Unconjugated	1 mg	38730
AS10 1417	Goat anti-Llama IgG (H&L), ALP conjugated	0.5 mg	42860

Cat. No.	Product Description	Pack Size	Price
AS10 1418	Goat anti-Llama IgG (H&L), Biotin conjugated	1 mg	42860
AS10 1419	Goat anti-Llama IgG (H&L), FITC conjugated	1 mg	42860
AS10 1420	Goat anti-Llama IgG (H&L), HRP conjugated	1 mg	42860
AS10 1421	Goat anti-Llama IgG (H&L), TRITC conjugated	1 mg	42860
AS10 1422	Goat anti-Llama IgG (H&L), DyLight® 488 conjugated	1 mg	46991
AS10 1423	Goat anti-Mouse IgG (H&L), Affinity purified, Unconjugated, min. cross-reactivity to bovine, horse, human, pig or rabbit serum	2 mg	32361
AS10 1425	Goat anti-Mouse IgG (H&L), Biotin conjugated, min. cross-reactivity to bovine, horse, human, pig or rabbit serum	2 mg	40795
AS10 1426	Goat anti-Mouse IgG (H&L), FITC conjugated, min. cross-reactivity to bovine, horse, human, pig or rabbit serum	2 mg	40795
AS10 1427	Goat anti-Mouse IgG (H&L), HRP conjugated, min. cross-reactivity to bovine, horse, human, pig or rabbit serum	1 mg	32361
AS10 1428	Goat anti-Mouse IgG (H&L), TRITC conjugated, min. cross-reactivity to bovine, horse, human, pig or rabbit serum	1 mg	40795
AS10 1452	Goat anti-biotin, ALP conjugated	1 mg	40795
AS10 1453	Goat anti-biotin, FITC conjugated	1 mg	38730
AS10 1454	Goat anti-biotin, HRP conjugated	1 mg	38730
AS10 1455	Goat anti-biotin, TRITC conjugated	1 mg	38730
AS10 1457	Goat anti-Rabbit IgG (H&L), Affinity purified, Unconjugated, min. cross-reactivity to human serum	2 mg	32361
AS10 1458	Goat anti-Rabbit IgG (H&L), ALP conjugated, min. crossreactivity to human serum	1 mg	38730
AS10 1459	Goat anti-Rabbit IgG (H&L), Biotin conjugated, min. cross-reactivity to human serum	2 mg	38730
AS10 1461	Goat anti-Rabbit IgG (H&L), HRP conjugated, min. crossreactivity to human serum	1 mg	32361
AS10 1462	Goat anti-Rabbit IgG (H&L), TRITC conjugated, min. cross-reactivity to human serum	2 mg	38730
AS10 1464	Goat anti-Rabbit IgG (H&L), Affinity purified, Unconjugated, min. cross-reactivity to human, mouse, rat serum	2 mg	32361
AS10 1465	Goat anti-Rabbit IgG (H&L), ALP conjugated, min. crossreactivity to human, mouse, rat serum	1 mg	40795
AS10 1466	Goat anti-Rabbit IgG (H&L), Biotin conjugated, min. cross-reactivity to human, mouse, rat serum	2 mg	38730
AS10 1467	Goat anti-Rabbit IgG (H&L), FITC conjugated, min. cross-reactivity to human, mouse, rat serum	2 mg	38730
AS10 1468	Goat anti-Rabbit IgG (H&L), HRP conjugated, min. crossreactivity to human, mouse, rat serum	1 mg	32361
AS10 1469	Goat anti-Rabbit IgG (H&L), TRITC conjugated, min. cross-reactivity to human, mouse, rat serum	2 mg	38730
AS10 1470	Goat anti-Rabbit IgG (H&L), DyLight® 488 conjugated, min. cross-reactivity to human, mouse, rat serum proteins	1 mg	38730
AS10 1474	Rabbit anti-bovine IgG (H&L), FITC conjugated	2 mg	35803
AS10 1478	Rabbit anti-Cat IgG (H&L), Affinity purified, Unconjugated	2 mg	40795
AS10 1485	Rabbit anti-Chicken IgY (H&L), Affinity purified, Unconjugated	2 mg	38730
AS10 1488	Rabbit anti-Chicken IgY (H&L), FITC conjugated	2 mg	38730
AS10 1489	Rabbit anti-Chicken IgY (H&L), HRP conjugated	1 mg	38730
AS10 1490	Rabbit anti-Chicken IgY (H&L), TRITC conjugated	1 mg	38730
AS10 1492	Rabbit anti-Guinea pig IgG (H&L), Affinity purified, Unconjugated	1 mg	34427
AS10 1495	Rabbit anti-Guinea pig IgG (H&L), FITC conjugated	1 mg	36492
AS10 1496	Rabbit anti-Guinea pig IgG (H&L), HRP conjugated	1 mg	36492
AS10 1497	Rabbit anti-Guinea pig IgG (H&L), TRITC conjugated	1 mg	36492

Cat. No.	Product Description	Pack Size	Price
AS10 1499	Rabbit anti-Human IgG (H&L), Affinity purified, Unconjugated	2 mg	38730
AS10 1500	Rabbit anti-Human IgG (H&L), ALP conjugated	1 mg	40795
AS10 1501	Rabbit anti-Human IgG (H&L), Biotin conjugated	2 mg	40795
AS10 1502	Rabbit anti-Human IgG (H&L), FITC conjugated	2 mg	36492
AS10 1503	Rabbit anti-Human IgG (H&L), HRP conjugated	1 mg	40795
AS10 1504	Rabbit anti-Human IgG (H&L), TRITC conjugated	2 mg	36492
AS10 1506	Rabbit anti-Human IgM (μ chain), Affinity purified, Unconjugated	1 mg	40795
AS10 1507	Rabbit anti-Human IgM (μ chain), ALP conjugated	0.5 mg	53359
AS10 1508	Rabbit anti-Human IgM (μ chain), Biotin conjugated	1 mg	49228
AS10 1509	Rabbit anti-Human IgM (μ chain), FITC conjugated	1 mg	45097
AS10 1510	Rabbit anti-Human IgM (μ chain), HRP conjugated	1 mg	49228
AS10 1511	Rabbit anti-Human IgM (μ chain), TRITC conjugated	1 mg	45097
AS10 1513	Rabbit anti-Llama IgG (H&L), Affinity purified, Unconjugated	1 mg	40795
AS10 1514	Rabbit anti-Llama IgG (H&L), ALP conjugated	0.5 mg	42860
AS10 1515	Rabbit anti-Llama IgG (H&L), Biotin conjugated	1 mg	40795
AS10 1516	Rabbit anti-Llama IgG (H&L), FITC conjugated	1 mg	42860
AS10 1517	Rabbit anti-Llama IgG (H&L), HRP conjugated	1 mg	45097
AS10 1519	Rabbit anti-Llama IgG (H&L), DyLight® 488 conjugated	1 mg	46991
AS10 1520	Rabbit anti-Rat IgG (H&L), Affinity purified, Unconjugated	1 mg	36492
AS10 1521	Rabbit anti-Rat IgG (H&L), ALP conjugated	0.5 mg	38730
AS10 1522	Rabbit anti-Rat IgG (H&L), Biotin conjugated	1 mg	36492
AS10 1523	Rabbit anti-Rat IgG (H&L), FITC conjugated	1 mg	38730
AS10 1524	Rabbit anti-Rat IgG (H&L), HRP conjugated	1 mg	38730
AS10 1525	Rabbit anti-Rat IgG (H&L), TRITC conjugated	1 mg	36492
AS10 1527	Rabbit anti-Rat IgG (H&L), Affinity purified, Unconjugated, min. cross-reactivity to human serum	1 mg	38730
AS10 1529	Rabbit anti-Rat IgG (H&L), Biotin conjugated, min. crossreactivity to human serum	1 mg	36492
AS10 1531	Rabbit anti-Rat IgG (H&L), HRP conjugated, min. crossreactivity to human serum	1 mg	36492
AS10 1534	Sheep anti-Rabbit IgG (H&L), Affinity purified, Unconjugated	2 mg	34427
AS10 1537	Sheep anti-Rabbit IgG (H&L), FITC conjugated	2 mg	38730
AS10 1538	Sheep anti-Rabbit IgG (H&L), HRP conjugated	1 mg	36492
AS10 1539	Sheep anti-Rabbit IgG (H&L), TRITC conjugated	1 mg	38730
AS10 1541	Human normal serum (2 ml)	2 ml	28059
AS10 1542	Human normal serum (10 ml)	10 ml	34427
AS10 1543	Mouse normal serum (2 ml)	2 ml	32361
AS10 1544	Mouse normal serum (5 ml)	5 ml	28059
AS10 1545	Rabbit normal serum (2 ml)	2 ml	28059
AS10 1546	Rabbit normal serum (10 ml)	10 ml	38730
AS10 1547	Goat normal serum (2 ml)	2 ml	28059
AS10 1548	Goat normal serum (10 ml)	10 ml	38730
AS10 1549	Sheep normal serum (2 ml)	2 ml	28059
AS10 1550	Sheep normal serum (10 ml)	10 ml	38730
AS10 1551	Rat normal serum (2 ml)	2 ml	28059
AS10 1552	Rat normal serum (5 ml)	5 ml	30124
AS10 1553	Bovine normal serum (2 ml)	2 ml	28059
AS10 1554	Bovine normal serum (10 ml)	10 ml	38730
AS10 1555	Chicken normal serum (unspecified gender) (2 ml)	2 ml	28059
AS10 1556	Chicken normal serum (unspecified gender) (10 ml)	10 ml	38730
AS10 1557	Guinea Pig normal serum (2 ml)	2 ml	28059
AS10 1558	Guinea Pig normal serum (5 ml)	5 ml	32361

Cat. No.	Product Description	Pack Size	Price
AS10 1559	Syrian Hamster normal serum (2 ml)	2 ml	32361
AS10 1560	Syrian Hamster normal serum (5 ml)	5 ml	32361
AS10 1561	Horse normal serum (2 ml)	2 ml	28059
AS10 1562	Horse normal serum (10 ml)	10 ml	36492
AS10 1563	Donkey normal serum (2 ml)	2 ml	28059
AS10 1564	Donkey normal serum (10 ml)	10 ml	36492
AS10 1565	Pig (Swine) normal serum (2 ml)	2 ml	28059
AS10 1566	Pig (Swine) normal serum (10 ml)	10 ml	36492
AS10 1567	Cat normal serum (2 ml)	2 ml	28059
AS10 1568	Cat normal serum (10 ml)	10 ml	36492
AS10 1569	Dog normal serum (unspecified gender) (2 ml)	2 ml	28059
AS10 1570	Dog normal serum (unspecified gender) (10 ml)	10 ml	36492
AS10 1571	VEGFR1 Vascular endothelial growth factor receptor 1	0.2 mg	91224
AS10 1572	PAR-1 protease-activated receptor 1	0.2 mg	91224
AS10 1573	PAR-4 protease-activated receptor 4	0.2 mg	91224
AS10 1574	VEGFR 3 Vascular endothelial growth factor receptor 3	0.2 mg	91224
AS10 1575	VEGF Vascular endothelial growth factor	0.2 mg	91224
AS10 1576	UBQ Ubiquitin	0.2 mg	91224
AS10 1577	pAIB1 Amplified in breast cancer 1 protein	0.2 mg	91224
AS10 1578	VEGFR2 Vascular endothelial growth factor receptor 2	0.2 mg	91224
AS10 1579	HER2 Receptor tyrosine-protein kinase erbB-2	0.2 mg	91224
AS10 1580	PSA prostate specific antigen (chicken antibody)	0.2 mg	91224
AS10 1581	Deg2 Chloroplastic DegP-type serine protease 2	200 µl	79606
AS10 1583	AtpI CFoIV subunit of ATP synthase	100 µl	79606
AS10 1584	TAK1 serine/threonine protein kinase (300 ul)	300 µl	180484
AS10 1585	PPO Polyphenol oxidase	100 µl	79606
AS10 1586	AtpE Epsilon subunit of ATP synthase	100 µl	79606
AS10 1588	HtrA putative serine protease (300 ul)	300 µl	180484
AS10 1589	PPlase CYP37 peptidyl-prolyl cis-trans isomerase CYP37 (chloroplastic)	100 µl	79606
AS10 1590	AtpD CF1 delta subunit of ATP synthase (affinity purified)	100 µl	79606
AS10 1591	AtpD CF1 delta subunit of ATP synthase	100 µl	79606
AS10 1592	slI0528 Putative zinc metalloprotease slI0528	100 µl	79606
AS10 1594	slI0408 Putative thylakoid lumen PPlase	100 µl	79606
AS10 1595	PPlase CYP37 peptidyl-prolyl cis-trans isomerase CYP37 (chloroplastic) (300 ul)	300 µl	180484
AS10 1596	slr1821 putative zinc metalloprotease slr1821 (100 ul)	100 µl	79606
AS10 1597	Hellebrin (300 ul)	300 µl	180484
AS10 1598	SppA1 signal peptide peptidase (higher plants) (300 ul)	300 µl	180484
AS10 1599	Hik29 sensor histidine kinase (300 ul)	300 µl	180484
AS10 1600	Hik29 sensor histidine kinase	100 µl	79606
AS10 1601	STN8 Serine/threonine-protein kinase STN8 (chloroplastic)	50 µg	53875
AS10 1601	STN8 Serine/threonine-protein kinase STN8 (chloroplastic) (2 Units)	50 µg	41483
AS10 1601	STN8 Serine/threonine-protein kinase STN8 (chloroplastic) (3 Units or More)	50 µg	38730
AS10 1602	HtrA Putative serine protease	100 µl	79606
AS10 1603	HliA high light inducible protein (300 ul)	300 µl	180484
AS10 1604	AtpF CF0I subunit of ATP synthase	100 µl	79606
AS10 1605	SppA2 signal peptide peptidase (cyanobacterial) (300 ul)	300 µl	180484
AS10 1607	CYP38 Cyclophilin 38, peptidyl-prolyl cis-trans isomerase	100 µl	79606
AS10 1608	HhoA protease HhoA (SlI1427; Cyanobase) (300 ul)	300 µl	180484

Cat. No.	Product Description	Pack Size	Price
AS10 1609	slI0408 putative thylakoid lumen PPlase (300 ul)	300 µl	180484
AS10 1610	HliD High light inducible protein	100 µl	79606
AS10 1612	TAK1 Serine/threonine protein kinase TAK1	100 µl	79606
AS10 1613	SppA1 Signal peptide peptidase (higher plants)	100 µl	79606
AS10 1614	SppA1 signal peptide peptidase (cyanobacterial) (200 ul)	200 µl	79606
AS10 1615	HliD High light inducible protein (300 ul)	300 µl	180484
AS10 1616	HliA High light inducible protein	100 µl	79606
AS10 1617	HhoB protease HhoB (SlI1679; Cyanobase) (300 ul)	300 µl	180484
AS10 1618	CYP38 cyclophilin 38, peptidyl-prolyl cis-trans isomerase (300 ul)	300 µl	180484
AS10 1619	HhoA protease HhoA (SlI1427; Cyanobase) (100 ul)	100 µl	79606
AS10 1620	HhoB Protease HhoB (SlI1679; Cyanobase)	100 µl	79606
AS10 1621	slr1821 putative zinc metalloprotease slr1821 (300 ul)	300 µl	180484
AS10 1622	Hellethionin (300 ul)	300 µl	180484
AS10 1623	slI0528 putative zinc metalloprotease slI0528 (300 ul)	300 µl	180484
AS10 1624	SppA2 Signal peptide peptidase (cyanobacterial)	100 µl	79606
AS10 1626	Hellethionin	100 µl	79606
AS10 206PRE	Dehydrin, pre-immune serum	100 µl	26165
AS10 206S	Dehydrin blocking peptide	500 µg	23412
AS10 651	Enolase	200 µl	68505
AS10 652	Cu/ZnSOD Cu/Zn superoxide dismutase	100 µl	53875
AS10 652	Cu/ZnSOD Cu/Zn superoxide dismutase (2 Units)	100 µl	41483
AS10 652	Cu/ZnSOD Cu/Zn superoxide dismutase (3 Units or More)	100 µl	38730
AS10 653	Goat anti-Guinea pig IgG (H&L), HRP conjugated	1 mg	38730
AS10 654	Goat anti-Guinea pig IgG (H&L) HRP (horseradish peroxidase) conjugated min.cross-reactivity to human, bovine, hen, goat, hamster, horse, mouse, rabbit, rat and Sheep serum	1 mg	38730
AS10 655	Goat anti-Guinea pig IgG (H&L), Biotin conjugated	2 mg	38730
AS10 656	Goat anti-Guinea pig IgG (H&L), ALP conjugated	1 mg	38730
AS10 657	Rabbit anti-Goat IgG (H&L), ALP conjugated, min. crossreactivity to human, mouse and Rat IgG	0.5 mg	42860
AS10 658	Rabbit anti-Goat IgG (H&L), Biotin conjugated, min. cross-reactivity to human, mouse and Rat IgG	1 mg	38730
AS10 659	Rabbit anti-Goat IgG (H&L), HRP conjugated, min. crossreactivity to human, mouse and rat serum	1 mg	38730
AS10 660	Goat anti-Human IgA+IgG+IgM, HRP conjugated	1 mg	42860
AS10 661	Goat anti-Human IgA+ IgG+IgM, Biotin conjugated	2 mg	42860
AS10 662	Goat anti-Human IgG+IgA+IgM, ALP conjugated	1 mg	38730
AS10 663	Goat anti-Rat IgG (H&L), ALP conjugated, min. reactivity to Human and mouse IgG, highly adsorbed against mouse IgG	1 mg	45097
AS10 664	Goat anti-Human IgG Fc, HRP conjugated, min. reactivity to human IgA and IgM	1 mg	38730
AS10 665	Goat anti-Rabbit IgG (H&L), Affinity purified, Unconjugated	2 mg	38730
AS10 666	Goat anti-biotin, Affinity purified, Unconjugated	1 mg	38730
AS10 667	Goat anti-Rabbit IgG (H&L), HRP conjugated, min. crossreactivity to bovine/Human/goat/mouse/rat IgG	1 mg	38730
AS10 668	Goat anti-Rabbit IgG (H&L) HRP conjugated, min.crossreactivity to bovine/Human/mouse IgG/serum	1 mg	38730
AS10 671	AGO5 Argonaute 5	200 µg	74701
AS10 672	AGO6 Argonaute 6	100 µg	73151
AS10 673	AGO9 Argonaute 9	100 µg	73151
AS10 674	FER Ferritin (plant)	200 µl	68505
AS10 676	eEF1B-gamma1 and 2 elongation factor 1-gamma 1 and 2	200 µl	68505
AS10 677	eEF1B-beta1 and 2 elongation factor 1-beta1 and 1beta2	200 µl	68505

Cat. No.	Product Description	Pack Size	Price
AS10 678	eEF1B-alpha1 an 2 elongation factor 1B-alpha 1 and 1B-alpha 2	100 µl	68505
AS10 679	eEF1B-alpha2 elongation factor 1B-alpha 2	200 µl	68505
AS10 680	Tubulin alpha chain	100 µl	53875
AS10 680	Tubulin alpha chain (2 Units)	100 µl	41483
AS10 680	Tubulin alpha chain (3 Units or More)	100 µl	38730
AS10 681	Tubulin beta chain	100 µg	73151
AS10 682	PsbP-like protein (sll1418) cyanobacterial	200 µl	68505
AS10 683	HDEL Endoplasmic reticulum retention signal	100 µg	84059
AS10 683-25	HDEL Endoplasmic reticulum retention signal (25 µg)	25 µg	45527
AS10 685	ADH Alcohol dehydrogenase (hypoxia marker)	100 µl	68505
AS10 687	PR-1 Pathogenesis-related protein 1	50 µl	59554
AS10 687	PR-1 Pathogenesis-related protein 1 (2 Units)	50 µl	43376
AS10 687	PR-1 Pathogenesis-related protein 1 (3 Units or More)	50 µl	38730
AS10 687S	PR-1 Positive control/quantitation standard	100 µl	36664
AS10 687S	PR-1 Positive control/quantitation standard (2 Units)	100 µl	30640
AS10 687S	PR-1 Positive control/quantitation standard (3 Units or More)	100 µl	27199
AS10 688	HCP Hyper conserved protein	200 µl	68505
AS10 689	GluTR Glutamyl -tRNA reductase	200 µl	68505
AS10 690	Clathrin heavy-chain 1,2	100 µg	73151
AS10 690-ALP	Clathrin heavy-chain 1,2, ALP-conjugated (40 µg)	40 µg	79520
AS10 690-HRP	Clathrin heavy-chain 1,2, HRP-conjugated (40 µg)	40 µg	79520
AS10 690PRE	Clathrin heavy-chain, pre-immune serum	100 µl	26165
AS10 691	PDC Pyruvate decarboxylase	100 µl	68505
AS10 692	PsbI Small subunit I of PSII (cyanobacterial)	200 µl	68505
AS10 693	HemH Protoporphyrin ferrochelatase (cyanobacterial)	100 µl	68505
AS10 695	PsaB PSI-B core subunit of photosystem I	50 µl	53875
AS10 695	PsaB PSI-B core subunit of photosystem I (2 Units)	50 µl	41483
AS10 695	PsaB PSI-B core subunit of photosystem I (3 Units or More)	50 µl	38730
AS10 696	MARBP matrix attachment region-binding protein	100 µl	98580
AS10 697	Sporamin	100 µl	98580
AS10 698	Alkaline lipase (glyoxysomal lipase)	100 µl	98580
AS10 700	RA Rubisco activase	50 µl	53875
AS10 700	RA Rubisco activase (2 Units)	50 µl	41483
AS10 700	RA Rubisco activase (3 Units or More)	50 µl	38730
AS10 702	Actin-11	50 µl	53875
AS10 702	Actin-11 (2 Units)	50 µl	41483
AS10 702	Actin-11 (3 Units or More)	50 µl	38730
AS10 703	Deg5 protease Do-like 5 (chloroplastic)	200 µl	68505
AS10 704	PsbA D1 protein of PSII, DE-loop	50 µl	53875
AS10 704	PsbA D1 protein of PSII, DE-loop (2 Units)	50 µl	41483
AS10 704	PsbA D1 protein of PSII, DE-loop (3 Units or More)	50 µl	38730
AS10 705	P-Tyr Phosphotyrosine	100 µg	84059
AS10 706-100	3-nitroY Nitrotyrosine	100 µg	84059
AS10 706-25	3-nitroY Nitrotyrosine (25 µl)	25 µg	45527
AS10 707-100	Acetylated Lysine (monoclonal)	100 µl	84059
AS10 707-25	Acetylated lysine (25 µl)	25 µl	45527
AS10 708-100	8-Hydroxyguanosine DNA/RNA oxidative damage	100 µg	84059
AS10 708-25	8-Hydroxyguanosine DNA/RNA oxidative damage (25 µg)	25 µg	45527
AS10 709	Tic40 Inner envelope membrane translocon complex protein (chloroplast)	50 µl	53875

Cat. No.	Product Description	Pack Size	Price
AS10 709	Tic40 Inner envelope membrane translocon complex protein (chloroplast) (2 Units)	50 µl	41483
AS10 709	Tic40 Inner envelope membrane translocon complex protein (chloroplast) (3 Units or More)	50 µl	38730
AS10 710	H3 Histone H3 (rabbit antibody) (nuclear marker)	50 µl	53875
AS10 710	H3 Histone H3 (rabbit antibody) (nuclear marker) (2 Units)	50 µl	41483
AS10 710	H3 Histone H3 (rabbit antibody) (nuclear marker) (3 Units or More)	50 µl	38730
AS10 710A	H3 Histone H3 (affinity purified)	50 µg	53875
AS10 710A	H3 Histone H3 (affinity purified) (2 Units)	50 µg	41483
AS10 710A	H3 Histone H3 (affinity purified) (3 Units or More)	50 µg	38730
AS10 710-ALP	H3 Histone H3, ALP-conjugated (40 µg)	40 µg	79520
AS10 710-HRP	H3 Histone H3, HRP-conjugated (40 µg)	40 µg	79520
AS10 710PRE	H3 histone H3, pre-immune serum	100 µl	26165
AS10 711	DEG15 Endopeptidase (peroxisomal marker)	100 µg	64546
AS10 712	AMY Alpha-amylase	100 µl	68505
AS10 713	ICL Isocitrate lyase	200 µl	68505
AS10 715	FtsZ Prokaryotic cell division GTPase	50 µl	53875
AS10 715	FtsZ Prokaryotic cell division GTPase (2 Units)	50 µl	41483
AS10 715	FtsZ Prokaryotic cell division GTPase (3 Units or More)	50 µl	38730
AS10 716	Ramy 3D Alpha-amylase isozyme 3D	100 µg	73151
AS10 718	HTA9 Probable histone H2A variant 3	50 µg	53875
AS10 718	HTA9 Probable histone H2A variant 3 (2 Units)	50 µg	41483
AS10 718	HTA9 Probable histone H2A variant 3 (3 Units or More)	50 µg	38730
AS10 720	PHOT1 Phototropin-1	100 µl	68505
AS10 721	PHOT2 Phototropin-2	100 µl	68505
AS10 723	GDP-L-Galactose Phosphorylase	200 µl	68505
AS10 725	PGRL1 PGR5-like protein 1A (chloroplastic)	100 µl	68505
AS10 726	ABA tracer (alkaline phosphatase conjugated)	1000 assays	46883
AS10 727	Goat anti-Chicken IgY (H&L), Affinity purified, Unconjugated	2 mg	38730
AS10 728	Goat anti-Guinea pig (H&L) Affinity purified, Unconjugated	2 mg	38730
AS10 731	Goat anti-Human IgA heavy (alpha chain), Affinity purified, Unconjugated	2 mg	38730
AS10 732	Goat anti-Human IgA heavy (alpha chain), ALP conjugated	1 mg	38730
AS10 733	Goat anti-Human IgA heavy (alpha chain), Biotin conjugated	1 mg	38730
AS10 734	Goat anti-Human IgA (alpha chain), DyLight® 488 conjugated	1 mg	40795
AS10 736	Goat anti-Human IgA heavy (alpha chain), HRP conjugated	1 mg	38730
AS10 737	Goat anti-Human IgA heavy (alpha chain), Affinity purified, Unconjugated, min. cross-reactivity to bovine/mouse/rabbit serum	1 mg	38730
AS10 738	Goat anti-Human IgA heavy (alpha chain), ALP conjugated, min. cross-reactivity to bovine/mouse/rabbit serum	0.5 mg	38730
AS10 739	Goat anti-Human IgA heavy (alpha chain), Biotin conjugated, min. cross-reactivity bovine/mouse/rabbit serum	1 mg	38730
AS10 740	Goat anti-Human IgA heavy (alpha chain), HRP conjugated, min. cross-reactivity bovine/mouse/rabbit serum	1 mg	38730
AS10 743	Goat anti-Human IgA heavy (alpha chain), F(ab)'2 fragment, Unconjugated	1 mg	38730
AS10 745	Goat anti-Human IgA heavy (alpha chain), F(ab)'2 fragment, Biotin conjugated	0.5 mg	42860
AS10 746	Goat anti-Human IgA heavy (alpha chain), F(ab)'2 fragment, HRP conjugated	0.5 mg	38730
AS10 748	ADH/ALDH Alcohol/acetaldehyde dehydrogenase (bacterial/algal)	200 µl	68505

Cat. No.	Product Description	Pack Size	Price
AS10 749	Goat anti-Human IgE heavy (epsilon chain) Affinity purified, Unconjugated	2 mg	45097
AS10 750	Goat anti-Human IgE heavy (epsilon chain), ALP conjugated	1 mg	45097
AS10 751	Goat anti-Human IgE heavy (epsilon chain), Biotin conjugated	1 mg	42860
AS10 754	Goat anti-Human IgE heavy (epsilon chain), HRP conjugated	1 mg	42860
AS10 755	Goat anti-Human IgE heavy (epsilon chain), Affinity purified, Unconjugated, min. cross-reactivity to bovine/mouse/rabbit serum	1 mg	46991
AS10 756	Goat anti-Human IgE heavy (epsilon chain), ALP conjugated, min. cross-reactivity to bovine/mouse/rabbit serum	0.5 mg	46991
AS10 757	Goat anti-Human IgE heavy (epsilon chain), Biotin conjugated, min. cross-reactivity bovine/mouse/rabbit serum	1 mg	49228
AS10 758	Goat anti-Human IgE (epsilon chain), DyLight® 488 conjugated, min. cross-reactivity to bovine, mouse, rabbit serum	1 mg	55424
AS10 760	Goat anti-Human IgE heavy (epsilon chain), HRP conjugated, min. cross-reactivity bovine/mouse/rabbit serum	1 mg	53359
AS10 761	Goat anti-Human IgG (H&L), Affinity purified, Unconjugated	2 mg	38730
AS10 762	Goat anti-Human IgG (H&L), ALP conjugated	1 mg	38730
AS10 763	Goat anti-Human IgG (H&L), Biotin conjugated	2 mg	38730
AS10 764	Goat anti-Human IgG (H&L), HRP conjugated	1 mg	38730
AS10 765	Goat anti-Human IgG (H&L), DyLight® 488 conjugated	1 mg	38730
AS10 767	Goat anti-Human IgG (H&L), Affinity purified, Unconjugated, min. cross-reactivity to bovine/mouse/rabbit serum	2 mg	38730
AS10 768	Goat anti-Human IgG (H&L), ALP conjugated, min. cross-reactivity to bovine/mouse/rabbit serum	1 mg	38730
AS10 769	Goat anti-Human IgG (H&L), Biotin conjugated, min. cross-reactivity bovine/mouse/rabbit serum	2 mg	38730
AS10 772	Goat anti-Human IgG (H&L), HRP conjugated, min. cross-reactivity bovine/mouse/rabbit serum	1 mg	38730
AS10 773	Goat anti-Human IgG (H&L), F(ab)'2 fragment, Affinity purified, Unconjugated	1 mg	38730
AS10 774	Goat anti-Human IgG (H&L), F(ab)'2 fragment, ALP conjugated	0.5 mg	38730
AS10 775	Goat anti-Human IgG (H&L), F(ab)'2 fragment, Biotin conjugated	0.5 mg	38730
AS10 779	Goat anti-Human IgG (H&L), F(ab)'2 fragment, HRP conjugated	0.5 mg	38730
AS10 780	Goat anti-Human IgG (H&L), F(ab)'2 fragment, Affinity purified, Unconjugated, min. cross-reactivity to bovine/mouse/rabbit serum	1 mg	42860
AS10 781	Goat anti-Human IgG (H&L), F(ab)'2 fragment, ALP conjugated, min. cross-reactivity to bovine/mouse/rabbit serum	0.5 mg	38730
AS10 782	Goat anti-Human IgG (H&L), F(ab)'2 fragment, Biotin conjugated, min. cross-reactivity bovine/mouse/rabbit serum	0.5 mg	42860
AS10 785	Goat anti-Human IgG (H&L), F(ab)'2 fragment, HRP conjugated, min. cross-reactivity bovine/mouse/rabbit serum	0.5 mg	42860
AS10 786	Goat anti-Human IgG Fc, Affinity purified, Unconjugated	2 mg	38730
AS10 787	Goat anti-Human IgG Fc, ALP conjugated	1 mg	38730
AS10 788	Goat anti-Human IgG Fc, Biotin conjugated	2 mg	38730
AS10 789	Goat anti-Human IgG Fc, DyLight® 488 conjugated	1 mg	38730
AS10 791	Goat anti-Human IgG Fc, HRP conjugated	1 mg	38730
AS10 792	Goat anti-Human IgG Fc, Affinity purified, Unconjugated, min. cross-reactivity to bovine/mouse/rabbit serum	2 mg	42860
AS10 793	Goat anti-Human IgG Fc, ALP conjugated, min. crossreactivity to bovine/mouse/rabbit serum	1 mg	42860
AS10 794	Goat anti-Human IgG Fc, Biotin conjugated, min. crossreactivity bovine/mouse/rabbit serum	2 mg	46991

Cat. No.	Product Description	Pack Size	Price
AS10 797	Goat anti-Human IgG Fc, HRP conjugated, min. crossreactivity bovine/mouse/rabbit serum	1 mg	38730
AS10 798	SurA SurA	100 µl	79348
AS10 799	Goat anti-Human IgG Fc, Affinity purified, Unconjugated, min. cross-reactivity to human IgA+IgM, affinity purified	2 mg	42860
AS10 800	Goat anti-Human IgG Fc, ALP conjugated, min. crossreactivity to human IgA+IgM	1 mg	42860
AS10 801	Goat anti-Human IgG Fc, Biotin conjugated, min. crossreactivity to human IgA+IgM	2 mg	42860
AS10 804	Goat anti-Human IgG Fc, HRP conjugated, min. crossreactivity to human IgA+IgM	1 mg	42860
AS10 805	Goat anti-Human IgG Fc, F(ab)'2 fragment, Affinity purified, Unconjugated	1 mg	42860
AS10 806	Goat anti-Human IgG Fc, Biotin conjugated, F(ab)'2 fragment	0.5 mg	38730
AS10 810	Goat anti-Human IgG Fc, F(ab)'2 fragment, HRP conjugated	0.5 mg	42860
AS10 811	Goat anti-Mouse IgG (H&L), Affinity purified, Unconjugated	2 mg	42860
AS10 812	Goat anti-Human IgG Fc, F(ab)'2 fragment, Affinity purified, Unconjugated, min. cross-reactivity to bovine/mouse/rabbit serum	1 mg	42860
AS10 813	Goat anti-Human IgG Fc, F(ab)'2 fragment, ALP conjugated, min. cross-reactivity to bovine/mouse/rabbit serum	0.5 mg	45097
AS10 814	Goat anti-Human IgG Fc, F(ab)'2 fragment, Biotin conjugated, min. cross-reactivity bovine/mouse/rabbit serum	0.5 mg	45097
AS10 815	Goat anti-Human IgG Fc, F(ab)'2 fragment, DyLight® 488 conjugated, min. cross-reactivity to bovine, horse, mouse, rabbit serum proteins	0.5 mg	42860
AS10 817	Goat anti-Human IgG Fc, F(ab)'2 fragment, HRP conjugated, min. cross-reactivity bovine/mouse/rabbit serum	0.5 mg	42860
AS10 818	Chicken anti-Mouse IgG (H&L), Affinity purified, Unconjugated	2 mg	38730
AS10 819	Goat anti-Human IgM (µ chain), Affinity purified, Unconjugated	2 mg	42860
AS10 820	Rabbit anti-Mouse IgG (H&L), Affinity purified, Unconjugated	2 mg	38730
AS10 825	Goat anti-Human IgM (µ chain), Affinity purified, Unconjugated, min. cross-reactivity to human IgA+IgG	2 mg	42860
AS10 826	Goat anti-Human IgM ((µ chain), ALP conjugated, min. cross-reactivity to human IgA+IgG	1 mg	42860
AS10 828	Chicken anti-Rabbit IgG (H&L), Affinity purified, Unconjugated	2 mg	38730
AS10 829	Chicken anti-Rabbit IgG (H&L), ALP conjugated	1 mg	38730
AS10 831	Chicken anti-Rabbit IgG (H&L), DyLight® 488 conjugated	1 mg	45097
AS10 833	Chicken anti-Rabbit IgG (H&L), HRP conjugated	1 mg	38730
AS10 834	Chicken anti-Rabbit IgG (H&L), Affinity purified, Unconjugated, min. cross-reactivity to human, mouse IgG	1 mg	38730
AS10 835	Chicken anti-Rabbit IgG (H&L), ALP conjugated, min. cross-reactivity to human, mouse IgG	0.5 mg	38730
AS10 836	Chicken anti-Rabbit IgG (H&L), Biotin conjugated, min. cross-reactivity to human, mouse IgG	0.5 mg	38730
AS10 839	Chicken anti-Rabbit IgG (H&L), HRP conjugated, min. cross-reactivity to human, mouse IgG	0.5 mg	38730
AS10 840	Donkey anti-Rabbit IgG (H&L), Affinity purified, Unconjugated	2 mg	38730
AS10 841	Donkey anti-Rabbit IgG (H&L), ALP conjugated	1 mg	38730
AS10 842	Donkey anti-Rabbit IgG (H&L), Biotin conjugated	2 mg	38730
AS10 843	Donkey anti-Rabbit IgG (H&L), DyLight® 488 conjugated	1 mg	38730
AS10 845	Donkey anti-Rabbit IgG (H&L), HRP conjugated	1 mg	38730
AS10 846	Goat anti-Rabbit IgG (H&L), F(ab)'2 fragment, Unconjugated	1 mg	38730
AS10 847	Sml1 Suppressor of Mec1 lethality	50 µl	53875

Cat. No.	Product Description	Pack Size	Price
AS10 847	Sml1 Suppressor of Mec1 lethality (2 Units)	50 µl	41483
AS10 847	Sml1 Suppressor of Mec1 lethality (3 Units or More)	50 µl	38730
AS10 848	Goat anti-Rabbit IgG (H&L), F(ab)'2 fragment, ALP conjugated	0.5 mg	42860
AS10 849	Goat anti-Rabbit IgG (H&L), F(ab)'2 fragment, Biotin conjugated	0.5 mg	38730
AS10 852	Goat anti-Rabbit IgG (H&L), F(ab)'2 fragment, HRP conjugated	0.5 mg	38730
AS10 853	Goat anti-Rabbit IgG Fc, Affinity purified, Unconjugated	2 mg	38730
AS10 855	Goat anti-Rabbit IgG Fc, Biotin conjugated	2 mg	38730
AS10 858	Goat anti-Rabbit IgG Fc, HRP conjugated	1 mg	38730
AS10 859	Bovine IgG fraction	10 mg	23756
AS10 860	Bovine purified IgG (10 mg)	10 mg	28059
AS10 863	Chicken Ig fraction (10 mg)	10 mg	34427
AS10 866	Horse Ig fraction	10 mg	23756
AS10 867	Horse purified IgG (10 mg)	10 mg	32361
AS10 870	Guinea pig Ig fraction	10 mg	23756
AS10 871	Guinea pig purified IgG (10 mg)	10 mg	38730
AS10 874	Goat Ig fraction	10 mg	23756
AS10 875	Goat purified IgG (10 mg)	10 mg	32361
AS10 878	Hamster IgG fraction	10 mg	23756
AS10 882	Human purified IgG (10 mg)	10 mg	37697
AS10 897	Human purified IgG, Fc fragment (1 mg)	1 mg	49228
AS10 909	Human purified IgG, F(ab)'2 fragment (2 mg)	2 mg	40795
AS10 911	Mouse Ig fraction	10 mg	28059
AS10 912	Mouse purified IgG (10 mg)	10 mg	38730
AS10 915	Rabbit Ig fraction	10 mg	23756
AS10 916	Rabbit purified IgG (10 mg)	10 mg	34427
AS10 916-100	Rabbit purified IgG (100 mg)	100 mg (13.1 mg/)	59899
AS10 916-1g	Rabbit purified IgG (1g)	1 g	104304
AS10 919	AKIN10 SNF1-related protein kinase catalytic subunit alpha KIN10	100 µg	53875
AS10 920	AKIN11 SNF1-related protein kinase catalytic subunit alpha KIN11	50 µg	53875
AS10 920	AKIN11 SNF1-related protein kinase catalytic subunit alpha KIN11 (2 Units)	50 µg	41483
AS10 920	AKIN11 SNF1-related protein kinase catalytic subunit alpha KIN11 (3 Units or More)	50 µg	38730
AS10 921	Rabbit purified IgG, F(ab)'2 fragment (2 mg)	2 mg	40795
AS10 922	Rabbit purified IgG, F(ab)'2 fragment (50 mg)	50 mg	260235
AS10 923	Rat Ig fraction	10 mg	28059
AS10 924	Rat purified IgG (5 mg)	5 mg	38730
AS10 925	Rat purified IgG (50 mg)	50 mg	237517
AS10 927	Sheep Ig fraction	10 mg	28059
AS10 928	Sheep purified IgG (10 mg)	10 mg	38730
AS10 931	AtPCaP1 Arabidopsis thaliana plasma membrane cation-binding protein-1	100 µl	98580
AS10 932	Amyloid beta oligomer-specific monoclonal antibody (OMAB)	50 µg	102410
AS10 932B	Amyloid beta oligomer-specific monoclonal antibody (OMAB), Biotinylated	50 µg	102410
AS10 934	eEF1a Elongation factor 1-alpha	200 µl	68505
AS10 935	Dsp Death-specific protein	200 µl	67300
AS10 936	CGL78 YCF54	200 µl	68505
AS10 938	COX11 Cytochrome c oxidase assembly protein	200 µl	68505
AS10 939	PsaC PSI-C core subunit of photosystem I	50 µl	53875
AS10 939	PsaC PSI-C core subunit of photosystem I (2 Units)	50 µl	41483

LABORATORY REAGENTS, FINE CHEMICALS & FILTER PAPERS

LABORATORY REAGENTS, FINE CHEMICALS & FILTER PAPERS, MOLECULAR BIOLOGY REAGENTS

- General Laboratory Chemicals & Solvents
- Bioreagents, Biochemicals & Speciality Fine Chemicals
- Nanotechnology Products
- Dehydrated Culture Media
- DNA & Protein Tools
- Country of Origin: EU / India



CODE	PRODUCT	PACKING	PRICE
PB-6001	ISO-AMYL ALCOHOL LR (FOR MILK TESTING) 2.5LTR	2.5LTR	2,152.80
PB-6002	ISO-AMYL ALCOHOL LR (FOR MILK TESTING)-500ML	500ML	522.60
PB-6003	1-(3-DIMETHYLAMINOPROPYL)-3-ETHYL CARBODIIMIDE HYDROCHLORIDE-100GM	100GM	4,992.00
PB-6004	1-(3-DIMETHYLAMINOPROPYL)-3-ETHYL CARBODIIMIDE HYDROCHLORIDE-25GM	25GM	1,591.20
PB-6005	1,1,2,2-TETRACHLOROETHANE AR 98.5%-2.5LTR	2.5LTR	11700.00
PB-6006	1,1,2,2-TETRACHLOROETHANE AR 98.5%-500ML	500ML	2496.00
PB-6007	1,1,2,2-TETRACHLOROETHANE LR 98%-2.5LTR	2.5LTR	11076.00
PB-6008	1,1,2,2-TETRACHLOROETHANE LR 98%-500ML	500ML	2262.00
PBRM2506	1,3,5-TRIPHENYL TETRAZOLIUM FORMAZAN	5GM	6916.00
PB-6009	1,10 PHENANTHROLINE AR MONOHYDRATE-100GM	100GM	10951.20
PB-6010	1,10 PHENANTHROLINE AR MONOHYDRATE-25GM	25GM	3229.20
PB-6011	1,10 PHENANTHROLINE AR MONOHYDRATE-5GM	5GM	733.20
PB-6012	1,10 PHENANTHROLINE HCL AR 99.5%-25GM	25GM	3884.40
PB-6013	1,10 PHENANTHROLINE HCL AR 99.5%-5GM	5 GM	943.80
PB-6014	1,2,3-BENZOTRIAZOLE FOR SYNTHESIS-100GM	100GM	499.20
PB-6015	1,2,3-BENZOTRIAZOLE FOR SYNTHESIS-1KG	1KG	4,570.80
PB-6016	1,2,4 -TRIAZOLE FOR SYNTHESIS 98%	100GM	717.60
PB-6017	1,2,4 -TRIAZOLE FOR SYNTHESIS 98%	500GM	3,330.60
PB65599	2,3,5-TRIPHENYL TETRAZOLIUM CHLORIDE (TTC) EXTRAPURE, 99%	25GM	5,774.60
PB-6018	1,2-DIBROMOETHANE for Synthesis (ethylene dibromide)	500ML	2,979.60
PB-6019	1,2-DIBROMOETHANE for Synthesis (ethylene dibromide)	2.5LTR	12,339.60
PB-6020	1,2-DICHLOROBENZENE AR	500ML	717.60
PB-6021	1,2-DICHLOROBENZENE AR	2.5LTR	2,909.40
PB-6022	1,2-DICHLOROBENZENE LR	500ML	592.80
PB-6023	1,2-DICHLOROBENZENE LR	2.5LTR	2,496.00
PB-6024	1,2-DICHLOROETHANE AR 99% (EDC) (ETHYLENE CHLORIDE)-2.5LTR	2.5LTR	1,731.60
PB-6025	1,2-DICHLOROETHANE AR 99% (EDC) (ETHYLENE CHLORIDE)-500ML	500ML	483.60
PB-6026	1,2-DICHLOROETHANE LR 98% (EDC) (ETHYLENE CHLORIDE)-2.5LTR	2.5LTR	1,450.80
PB-6027	1,2-DICHLOROETHANE LR 98% (EDC) (ETHYLENE CHLORIDE)-500ML	500ML	413.40
PB-6028	1,2-NAPHTHOQUINONE-4 SULFONIC ACID SOD.SALT AR-25GM	25GM	2,316.60
PB-6029	1,2-NAPHTHOQUINONE-4 SULFONIC ACID SOD.SALT AR-5GM	5GM	577.20
PB-6030	1,3-DICHLOROBENZENE 98% (m-DICHLOROBENZENE)	500GM	1,357.20
PB-6031	1,3-DICHLOROBENZENE 98% (m-DICHLOROBENZENE)	2.5LTR	6,099.60
PB-6032	1,3-DIOXOLANE FOR SYNTHESIS 99%	500ML	1,037.40
PB-6033	1,3-DIOXOLANE FOR SYNTHESIS 99%	2.5LTR	5,132.40
PB-6034	1,4- DICHLOROBENZENE FOR SYNTHESIS 99%	500GM	452.40
PB-6035	1,4 -DIOXAN AR (FOR SCIENTILATION GRADE)-2.5LTR	2.5LTR	3,400.80
PB-6036	1,4 -DIOXAN AR (FOR SCIENTILATION GRADE)-500ML	500ML	764.40
PB-6037	1,4 -DIOXAN AR-2.5LTR	2.5LTR	3,533.40
PB-6038	1,4 -DIOXAN AR-500ML	500ML	819.00
PB-6039	1,4 -DIOXAN LR-2.5LTR	2.5LTR	2,940.60

CODE	PRODUCT	PACKING	PRICE
PB-6040	1,4 -DIOXAN LR-500ML	500ML	733.20
PB-6041	1,4 -DIOXAN SPECIALLY DRIED AR	500ML	748.80
PB-6042	1,4-DIAZABICYCLO(2,2,2) OCTANE FOR SYNTHESIS-100GM	100GM	1,318.20
PB-6043	1,4-DIAZABICYCLO(2,2,2) OCTANE FOR SYNTHESIS-500GM	500GM	3,884.40
PB-6044	1,4-DIOXAN COCKTAIL SCINTILATION GRADE-2.5LTR	2.5LTR	3,884.40
PB-6045	1,4-DIOXAN FOR HPLC & UV SPECTROSCOPY	1LTR	1,661.40
PB-6046	1,6 HEXANDIOL	500GM	1,177.80
PB-6047	1-2 DIMETHOXYETHANE (Ethylene glycol dimethyl ether)-2.5LTR	2.5LTR	2652.00
PB-6048	1-2 DIMETHOXYETHANE(Ethylene glycol dimethyl ether)-500ML	500ML	1248.00
PB-6049	18-CROWN 6-ETHER 99%-100GM	100GM	4,570.80
PB-6050	18-CROWN 6-ETHER 99%-25GM	25GM	1,591.20
PB-6051	18-CROWN 6-ETHER 99%-5GM	5GM	499.20
PB-6052	1-AMINO-2-NAPHTHOL-4-SULFONIC ACID AR -25GM	25GM	522.60
PB-6053	1-AMINO-2-NAPHTHOL-4-SULFONIC ACID AR-100GM	100GM	1,733.16
PB-6054	1-AMINO-2-NAPHTHOL-4-SULFONIC ACID LR- 100GM	100GM	1,287.00
PB-6055	1-AMINO-2-NAPHTHOL-4-SULFONIC ACID LR- 25GM	25GM	374.40
PB-6056	1-AMINO GUANIDINE HYDROGEN CARBONATE FOR SYNTHESIS-100GM	100GM	444.60
PB-6057	1-AMINO GUANIDINE HYDROGEN CARBONATE FOR SYNTHESIS-500GM	500GM	1,669.20
PB-6058	1-BROMOPROPANE FOR SYNTHESIS 98.5%(n-Propyl Bromide)	500ML	1,661.40
PB-6059	1-BROMOPROPANE FOR SYNTHESIS 98.5%(n-Propyl Bromide)	2.5LTR	6,099.60
PB-6060	1-BUTANE SULFONIC ACID SODIUM SALT ANHYDROUS(FOR HPLC)-25GM	25GM	1716.00
PB-6061	1-BUTANE SULFONIC ACID SODIUM SALT ANHYDROUS(FOR HPLC)-5GM	5GM	530.40
PB-6062	1-BUTANE SULFONIC ACID SODIUM SALT MONOHYDRATE (FOR HPLC)	5GM	530.40
PB-6063	1-BUTANE SULFONIC ACID SODIUM SALT MONOHYDRATE (FOR HPLC)	25GM	1716.00
PB-6064	1-DECANE SULPHONIC ACID SODIUM SALT AR (MONOHD)	5GM	468.00
PB-6065	1-DECANE SULPHONIC ACID SODIUM SALT AR (MONOHD)	25GM	1872.00
PB-6066	1-DECANE SULPHONIC ACID SODIUM SALT AR(FOR HPLC)-25GM	25GM	1872.00
PB-6067	1-DECANE SULPHONIC ACID SODIUM SALT AR(FOR HPLC)-5GM	5GM	436.80
PB-6068	1-DODECANE SULPHONIC ACID SOD SALT HPLC- 5GM	5GM	858.00
PB-6069	1-DODECANE SULPHONIC ACID SOD SALT HPLC-25GM	25GM	3510.00
PB-6070	1-HEPTANE SULPHONIC ACID SODIUM SALT AR (ANHYDROUS)-100GM	100GM	6084.00
PB-6071	1-HEPTANE SULPHONIC ACID SODIUM SALT AR (ANHYDROUS)-25GM	25GM	1684.80
PB-6072	1-HEPTANE SULPHONIC ACID SODIUM SALT AR (MONOHYDRATE) For HPLC-100GM	100GM	6084.00
PB-6073	1-HEPTANE SULPHONIC ACID SODIUM SALT AR (MONOHYDRATE) For HPLC-25GM	25GM	1684.80
PB-6074	1-HEPTANE SULPHONIC ACID SODIUM SALT AR (MONOHYDRATE) For HPLC-5GM	5GM	733.20
PB-6075	1-HEXANE SULPHONIC ACID SODIUM SALT AR (ANHYDROUS)-100GM	100GM	6006.00
PB-6076	1-HEXANE SULPHONIC ACID SODIUM SALT AR (ANHYDROUS)-25GM	25GM	1684.80
PB-6077	1-HEXANESULPHONIC ACID SODIUM SALT AR (MONOHYDRATE)-100GM	100GM	6006.00
PB-6078	1-HEXANESULPHONIC ACID SODIUM SALT AR (MONOHYDRATE)-25GM	25GM	1684.80
PB-6079	1-HEXANESULPHONIC ACID SODIUM SALT AR (MONOHYDRATE)-5GM	5GM	1014.00
PB-6080	1H-TETRAZOLE FOR DNA SYNTHESIS-1GM	1GM	561.60
PB-6081	1H-TETRAZOLE FOR DNA SYNTHESIS-25GM	25GM	9048.00
PB-6082	1H-TETRAZOLE FOR DNA SYNTHESIS-5GM	5GM	2418.00
PB-6083	1-HYDROXYBENZOTRIAZOLE (MONOHYDRATE)-100GM	100GM	1,287.00
PB-6084	1-HYDROXYBENZOTRIAZOLE (MONOHYDRATE)-25GM	25GM	343.20
PB-6085	1-NAPHTHOL AR-100GM	100GM	655.20
PB-6086	1-NAPHTHOL AR-500GM	500GM	2,636.40
PB-6087	1-NAPHTHOL-100GM	100GM	569.40
PB-6088	1-NAPHTHOL-500GM	500GM	2,355.60
PB-6089	1-NAPHTHOLBENZEIN (PH INDICATOR)-25GM	25GM	4,914.00
PB-6090	1-NAPHTHOLBENZEIN (PH INDICATOR)-5GM	5GM	1,014.00
PB-6091	1-NAPHTHOLPHTHALEIN (pH INDICATOR)-1GM	1GM	1,006.20
PB-6092	1-NAPHTHOLPHTHALEIN (pH INDICATOR)-5GM	5GM	3,814.20
PB-6093	1-NAPHTHYL ACETIC ACID (NAPHTHALENE ACETIC ACID)-100GM	100GM	803.40

CODE	PRODUCT	PACKING	PRICE
PB-6094	1-NAPHTHYL ACETIC ACID {NAPHTHALENE ACETIC ACID}-25GM	25GM	312.00
PB-6095	1-NAPHTHYL ACETIC ACID {NAPHTHALENE ACETIC ACID}-500GM	500GM	3432.00
PB-6096	1-NAPTHORESORCINOL AR-1GM	1GM	6084.00
PB-6097	1-NAPTHORESORCINOL AR-5GM	5GM	28236.00
PB-6098	1-NITROSO-2-NAPTHOL AR-100GM	100GM	3432.00
PB-6099	1-NITROSO-2-NAPTHOL AR-25GM	25GM	1248.00
PB-6100	1-NITROSO-2-NAPTHOL-100GM	100GM	2652.00
PB-6101	1-NITROSO-2-NAPTHOL-250GM	250GM	6240.00
PB-6102	1-OCTANE SULPHONIC ACID SODIUM SALT (MONOHYDRATE) AR-100GM	100GM	5616.00
PB-6103	1-OCTANE SULPHONIC ACID SODIUM SALT (MONOHYDRATE) AR-25GM	25GM	1684.80
PB-6104	1-OCTANE SULPHONIC ACID SODIUM SALT (MONOHYDRATE) AR-5GM	5GM	889.20
PB-6105	1-OCTANE SULPHONIC ACID SODIUM SALT (ANHYDROUS) AR For HPLC-100GM	100GM	5616.00
PB-6106	1-OCTANE SULPHONIC ACID SODIUM SALT (ANHYDROUS) AR For HPLC-25GM	25GM	1684.80
PB-6107	1-PENTANE SULFONIC ACID SODIUM SALT FOR HPLC (ANHYDROUS)-100GM	100GM	5616.00
PB-6108	1-PENTANE SULFONIC ACID SODIUM SALT FOR HPLC (ANHYDROUS)-25GM	25GM	1684.80
PB-6109	1-PENTANE SULFONIC ACID SODIUM SALT FOR HPLC (MONOHYDRATE)-100GM	100GM	5616.00
PB-6110	1-PENTANE SULFONIC ACID SODIUM SALT FOR HPLC (MONOHYDRATE)-25GM	25GM	1684.80
PB-6111	1-PENTANE SULFONIC ACID SODIUM SALT FOR HPLC (MONOHYDRATE)-5GM	5GM	858.00
PB-6112	2, 6-LUTIDINE FOR SYNTHESIS 99%	500ML	2,566.20
PB-6113	2,2,4-TRIMETHYLPENTANE (iso-Octane) 99.5%- 500ML	500ML	1,263.60
PB-6114	2,2,4-TRIMETHYLPENTANE (iso-Octane) 99.5%-2.5LTR	2.5LTR	5,686.20
PB-6115	2,2,4-TRIMETHYLPENTANE (iso-Octane) FOR HPLC	1LTR	3,120.00
PB-6116	2,2,4-TRIMETHYLPENTANE (iso-Octane) FOR HPLC	2.5LTR	6,583.20
PB-6117	2,2,4-TRIMETHYLPENTANE AR 99.5%-2.5LTR	2.5LTR	6,099.60
PB-6118	2,2,4-TRIMETHYLPENTANE AR 99.5%-500ML	500ML	1,450.80
PB-6119	2,2-DIMETHOXY PROPANE for Synthesis	500ML	1,037.40
PB-6120	2,2-DIMETHOXY PROPANE for Synthesis	2.5LTR	4,992.00
PB-6121	2,3,5-TRIPHENYL TETRAZOLIUM BROMIDE AR-1GM	1GM	1872.00
PB-6122	2,3-DICHLORO-5,6-DICYANOBENZOQUINONE FOR SYNTHESIS (DDQ) -100GM	100GM	3,603.60
PB-6123	2,3-DICHLORO-5,6-DICYANOBENZOQUINONE FOR SYNTHESIS (DDQ) -500GM	500GM	17,331.60
PB-6124	2,3-LUTIDINE (2,3-DIMETHYLPYRIDENE) FOR SYNTHESIS-250ML	250ML	4,024.80
PB-6125	2,4 -DICHLOROPHENOL FOR SYNTHESIS	100GM	499.20
PB-6126	2,4 -DICHLOROPHENOL FOR SYNTHESIS	500GM	1,872.00
PB-6127	2,4,6-TRI-(2-PYRIDYL)1,3,5-TRIAZINE AR-1GM	1GM	1794.00
PB-6128	2,4,6-TRI-(2-PYRIDYL)1,3,5-TRIAZINE AR-5GM	5GM	6864.00
PB-6129	2,4-DICHLOROBENZOIC ACID FOR SYNTHESIS 98%	100GM	413.40
PB-6130	2,4-DICHLOROBENZOIC ACID FOR SYNTHESIS 98%	500GM	1,318.20
PB-6131	2,4-DINITROPHENOL INDICATOR AR-100GM	100GM	1,279.20
PB-6132	2,4-DINITROPHENOL INDICATOR AR-25GM	25GM	421.20
PB-6133	2,4-DINITROPHENYL HYDRAZINE AR -100GM	100GM	787.80
PB-6134	2,4-DINITROPHENYL HYDRAZINE AR -25GM	25GM	226.20
PB-6135	2,4-DINITROPHENYL HYDRAZINE-100GM	100GM	733.20
PB-6136	2,4-DINITROPHENYL HYDRAZINE-25GM	25GM	187.20
PB-6137	2,6 XYLIDINE PURE-2.5LTR	2.5LTR	7,488.00
PB-6138	2,6 XYLIDINE PURE-250ML	250ML	943.80
PB-6139	2,6-DICHLOROPHENOL For Synthesis 98%	100GM	1,388.40
PB-6140	2,6-DICHLOROPHENOL For Synthesis 98%	500GM	5,405.40
PB-6141	2,6-DICHLOROPHENOL INDOPHENOL SODIUM SALT AR-25GM	25GM	5,686.20
PB-6142	2,6-DICHLOROPHENOL INDOPHENOL SODIUM SALT AR-5GM	5GM	1,411.80
PB-6143	2,6-DICHLOROQUINONE -4-CHLORIMIDE AR(Gibb's reagent)-10GM	10GM	5616.00
PB-6144	2,6-DICHLOROQUINONE -4-CHLORIMIDE AR(Gibb's reagent)-5GM	5GM	2964.00
PB-6145	2,7-DICHLORO FLUOROSCEIN AR (absorption indicator)-10GM	10GM	1,770.60
PB-6146	2,3,5-TRIIODOBENZOIC ACID AR(TIBA)-10GM	10GM	3400.80
PB-6147	2,3,5-TRIIODOBENZOIC ACID AR(TIBA)-5GM	5GM	1731.60
PB-6148	2-2-BIPYRIDYL AR-25GM	25GM	3,837.60
PB-6149	2-2-BIPYRIDYL AR-5GM	5GM	819.00

CODE	PRODUCT	PACKING	PRICE
PB-6150	2-AMINO-2-METHYL-1,3-PROPANEDIOL AR-100GM	100GM	3,884.40
PB-6151	2-AMINO-2-METHYL-1,3-PROPANEDIOL AR-500GM	500GM	19,827.60
PB-6152	2-AMINO-2-METHYL-1-PROPANOL LR (AMP)- 2.5LTR	2.5LTR	11,653.20
PB-6153	2-AMINO-2-METHYL-1-PROPANOL LR (AMP)-500ML	500ML	2,425.80
PB-6154	2-AMINOPHENOL 99%- 100GM	100GM	943.80
PB-6155	2-AMINOPHENOL 99% -250GM	250GM	1,622.40
PB-6156	2-AMINOPYRIDINE FOR SYNTHESIS - 100GM	100GM	764.40
PB-6157	2-AMINOPYRIDINE FOR SYNTHESIS - 250GM	250GM	1,599.00
PB-6158	2-BROMOETHYLAMINE HYDROBROMIDE FOR SYNTHESIS 99%	500GM	5,475.60
PB-6159	2-BUTOXYETHANOL AR 98.5%	500ML	585.00
PB-6160	2-BUTOXYETHANOL AR 98.5%	2.5LTR	2,636.40
PB-6161	2-BUTOXYETHANOL LR 98% (Butyl Glycol Ether)-2.5LTR	2.5LTR	2,285.40
PB-6162	2-BUTOXYETHANOL LR 98% (Butyl Glycol Ether)-500ML	500ML	452.40
PB-6163	2-CHLOROBENZALDEHYDE FOR SYNTHESIS	100 ML	663.00
PB-6164	2-CHLOROBENZALDEHYDE FOR SYNTHESIS	500ML	1,450.80
PB-6165	2-ETHOXYETHANOL AR 99.5%	500ML	624.00
PB-6166	2-ETHOXYETHANOL AR 99.5%	2.5LTR	2,355.60
PB-6167	2-ETHOXYETHANOL LR 99%	500ML	499.20
PB-6168	2-ETHOXYETHANOL LR 99%	2.5LTR	2,152.80
PB-6169	2-ETHYL HEXANOL FOR SYNTHESIS 99%	500ML	569.40
PB-6170	2-ETHYL HEXANOL FOR SYNTHESIS 99%	2.5LTR	2,355.60
PB-6171	2-HYDROXY-1-NAPHTHALDEHYDE	100GM	6,169.80
PB-6172	2-MERCAPTOBENZIMIDAZOLE FOR SYNTHESIS-250GM	250GM	1,154.40
PB-6173	2-MERCAPTOBENZIMIDAZOLE FOR SYNTHESIS-500GM	500GM	2,074.80
PB-6174	2-MERCAPTOBENZOIC ACID AR 99%	100gm	1,731.60
PB-6175	2-MERCAPTOBENZOIC ACID AR 99%	500GM	7,488.00
PB-6176	2-MERCAPTOBENZOTHAZOLE 99% AR 100GM	100GM	1,068.60
PB-6177	2-MERCAPTOBENZOTHAZOLE 99% AR 25GM	25GM	304.20
PB-6178	2-MERCAPTOBENZOTHAZOLE 99% AR 500GM	500GM	3,190.20
PB-6179	2-MERCAPTOETHANOL AR-100ML	100ML	1092.00
PB-6180	2-MERCAPTOETHANOL AR-250ML	250ML	2418.00
PB-6181	2-MERCAPTOETHANOL FOR SYNTHESIS-100ML	100ML	811.20
PB-6182	2-MERCAPTOETHANOL FOR SYNTHESIS-500ML	500ML	3510.00
PB-6183	2-METHOXYBENZALDEHYDE (o-Anisaldehyde)	100GM	6,942.00
PB-6184	2-METHOXYETHANOL AR	500ML	717.60
PB-6185	2-METHOXYETHANOL AR	2.5LTR	2,909.40
PB-6186	2-METHOXYETHANOL LR	500ML	639.60
PB-6187	2-METHOXYETHANOL LR	2.5LTR	2,636.40
PB-6188	2-METHYLIMIDAZOLE LR 98%	100GM	452.40
PB-6189	2-METHYLIMIDAZOLE LR 98%	500GM	1,934.40
PB-6190	2-NAPHTHOL AR-100GM	100GM	304.20
PB-6191	2-NAPHTHOL AR-500GM	500GM	1,287.00
PB-6192	2-NAPHTHOL FOR SYNTHESIS-500GM	500GM	967.20
PB-6193	2-NITROANILINE PURE 98%	250GM	1326.00
PB-6194	2-NITROBENZALDEHYDE AR-10GM	10GM	202.80
PB-6195	2-NITROBENZALDEHYDE AR-1KG	1KG	13587.60
PB-6196	2-NITROBENZALDEHYDE AR-25GM	25GM	553.80
PB-6197	2-PHENOXYETHANOL FOR SYNTHESIS-2.5LTR	2.5LTR	3744.00
PB-6198	2-PHENOXYETHANOL FOR SYNTHESIS-500ML	500ML	1068.60
PB-6199	2-PYROLIDONE LR-2.5LTR	2.5LTR	6708.00
PB-6200	2-PYROLIDONE LR-500ML	500ML	1872.00
PB-6201	2-THENOYL TRIFLUOROACETONE AR-100GM	100GM	14,976.00
PB-6202	2-THENOYL TRIFLUOROACETONE AR-10GM	10GM	1,872.00
PB-6203	3-(2-PYRIDYL)-5,6-DIPHENYL 1,2,4-TRIAZINE -1GM	1GM	4118.40
PB-6204	3-(2-PYRIDYL)-5,6-DIPHENYL 1,2,4-TRIAZINE AR -1GM	1GM	2106.00
PB-6205	3-(2-PYRIDYL)-5,6-DIPHENYL 1,2,4-TRIAZINE AR -5GM	5GM	8533.20

CODE	PRODUCT	PACKING	PRICE
PB-6206	3,3',5,5'-TETRAMETHYL BENZIDINE AR-1GM	1GM	2,028.00
PB-6207	3,3',5,5'-TETRAMETHYL BENZIDINE AR-5GM	5GM	7,332.00
PB-6208	3,5-DINITROBENZOIC ACID -500GM	500GM	2,776.80
PB-6209	3,5-DINITROBENZOIC ACID AR -100GM	100GM	655.20
PB-6210	3,5-DINITROBENZOIC ACID AR -500GM	500GM	3,049.80
PB-6211	3,5-DINITROSALICYLIC ACID AR-100GM	100GM	3,049.80
PB-6212	3,5-DINITROSALICYLIC ACID AR-25GM	25GM	928.20
PB-6213	3,5-DINITROSALICYLIC ACID-100GM	100GM	2,285.40
PB-6214	3,5-DINITROSALICYLIC ACID-25GM	25GM	592.80
PB-6215	3-AMINOBENZOIC ACID FOR SYNTHESIS 98%	100GM	709.80
PB-6216	3-AMINOBENZOIC ACID FOR SYNTHESIS 98%	500GM	2,808.00
PB-6217	3-METHYL-2-BENZOTHAZOLINONE HYDRAZONE HYDROCHLORIDE AR (MBTH)-10GM	10GM	6,520.80
PB-6218	3-METHYL-2-BENZOTHAZOLINONE HYDRAZONE HYDROCHLORIDE AR (MBTH)-25GM	25GM	15,116.40
PB-6219	3-NITROANILINE -250GM	250GM	1076.40
PB-6220	4-(DIMETHYLAMINO) PYRIDINE FOR SYNTHESIS-1KG	1KG	12,901.20
PB-6221	4-(DIMETHYLAMINO) PYRIDINE FOR SYNTHESIS-25GM	25GM	764.40
PB-6222	4-AMINOANTIPYRINE PURISS-100GM	100GM	4,024.80
PB-6223	4-AMINOANTIPYRINE PURISS-25GM	25GM	998.40
PB-6224	4-AMINOBENZOIC ACID PURE- 500GM	500GM	2,496.00
PB-6225	4-AMINOBENZOIC ACID PURE-100GM	100GM	873.60
PB-6226	4-AMINOBUTYRIC ACID FOR SYNTHESIS (GABA)-100GM	100GM	2,636.40
PB-6227	4-AMINOBUTYRIC ACID FOR SYNTHESIS (GABA)-25GM	25GM	764.40
PB-6228	4-AMINOPHENOL- 250GM	250GM	795.60
PB-6229	4-AMINOPHENOL-100GM	100GM	390.00
PB-6230	4-AMINOPYRIDINE 98%	10GM	733.20
PB-6231	4-AMINOPYRIDINE 98%	100GM	6,099.60
PB-6232	4-BROMO ANILINE FOR SYNTHESIS 98% 100GM	100GM	1,591.20
PB-6233	4-BROMO ANILINE FOR SYNTHESIS 98% 25GM	25GM	592.80
PB-6234	4-BROMO ANILINE FOR SYNTHESIS 98% 500GM	500GM	5,686.20
PB-6235	4-BROMOACETANILIDE 98% FOR SYNTHESIS	100GM	1,528.80
PB-6236	4-BROMOACETANILIDE 98% FOR SYNTHESIS	500GM	7,488.00
PB-6237	4-CHLORO BENZALDEHYDE for synthesis-100GM	100GM	702.00
PB-6238	4-CHLORO BENZALDEHYDE for synthesis-500GM	500GM	3,049.80
PB-6239	4-CHLORO-m-CRESOL-500GM	500GM	2,355.60
PB-6240	4-CHLORO-m-CRESOL-5KG	5KG	22,183.20
PB-6241	4-CHLOROPHENOL FOR SYNTHESIS 98%	500GM	803.40
PB-6242	4-DIMETHYLAMINO PYRIDINE (DMAP) FOR SYNTHESIS-100GM	100GM	2,012.40
PB-6243	4-FLUORO BORIC ACID 40%-500ML	500ML	787.80
PB-6244	4-FLUORO BORIC ACID 40%-5LTR	5LTR	5,545.80
PB-6245	4-FLUOROANILINE FOR SYNTHESIS (1-Amino-4-Fluorobenzene)-100GM	100GM	1,318.20
PB-6246	4-FLUOROANILINE FOR SYNTHESIS (1-Amino-4-Fluorobenzene)-1KG	1KG	6,513.00
PB-11407	FORMALDEHYDE ACS Grade, Clear, Colorless (Formalin)Solution 5L	5LTR	26595.4
PB-6247	4-HYDROXYBENZALDEHYDE FOR SYNTHESIS-100GM	100GM	733.20
PB-6248	4-HYDROXYBENZALDEHYDE FOR SYNTHESIS-250GM	250GM	2,776.80
PB-6249	4-NITROANILINE LR (1-Amino-4-nitrobenzene) C.I. 37035 -250GM	250GM	936.00
PB-6250	4-NITROANILINE LR (1-Amino-4-nitrobenzene) C.I. 37035-500GM	500GM	1684.80
PB-6251	4-NITROBENZALDEHYDE AR-100GM	100GM	5460.00
PB-6252	4-NITROBENZALDEHYDE AR-25GM	25GM	1482.00
PB-6253	4-NITROBENZOIC ACID 99%-500GM	500GM	1326.00
PB-6254	4-NITROPHENYL PHOSPHATE DISODIUM SALT AR-25GM	25GM	3814.20
PB-6255	4-NITROPHENYL PHOSPHATE DISODIUM SALT AR-5GM	5GM	787.80
PB-6256	4-NITROTOLUENE FOR SYNTHESIS -500GM	500GM	483.60
PB-6257	4-TOLUENESULFONYL CHLORIDE-500GM	500GM	998.40
PB-6258	5-diazo uracil for biochemistry	1GM	2,917.20
PB-6259	5-FLUORO URACIL -25GM	25GM	9,703.20

CODE	PRODUCT	PACKING	PRICE
PB-6260	5-FLUORO URACIL-1GM	1GM	639.60
PB-6261	5-FLUORO URACIL-5GM	5GM	2,074.80
PB-6262	5-FLUOROCYTOSIN FOR SYNTHESIS-100ML	100ML	4,024.80
PB-6263	5-SULPHOSALICYLIC ACID AR-250GM	250GM	780.00
PB-6264	5-SULPHOSALICYLIC ACID AR-500GM	500GM	1,341.60
PB-6265	5-SULPHOSALICYLIC ACID LR-250GM	250GM	663.00
PB-6266	5-SULPHOSALICYLIC ACID LR-500GM	500GM	1,177.80
PB-6267	6-AMINO CAPROIC ACID 99% FOR BIOCHEMISTRY	100GM	1,302.60
PB-6268	6-AMINO CAPROIC ACID 99% FOR BIOCHEMISTRY	500GM	6,099.60
PB-6269	6-BENZYL ADENINE-25GM	25GM	3,190.20
PB-6270	6-BENZYL ADENINE-5GM	5GM	967.20
PB-6271	7-AZAINDOLE FOR SYNTHESIS 98%	1GM	1,123.20
PB-6272	7-AZAINDOLE FOR SYNTHESIS 98%	5GM	3,049.80
PB-6273	8-HYDROXYQUINOLINE (OXINE)-100GM	100GM	1248.00
PB-6274	8-HYDROXYQUINOLINE (OXINE)-500GM	500GM	5,132.40
PB-6275	8-HYDROXYQUINOLINE AR-100GM	100GM	1,700.40
PB-6276	8-HYDROXYQUINOLINE AR-500GM	500GM	6,442.80
PB-6277	9-FLUORENYLMETHYL CHLOROFORMATE (FMOC-Cl)	25GM	2,909.40
PB-6278	9-FLUORENYLMETHYL CHLOROFORMATE (FMOC-Cl)-100GM	100GM	9,703.20
PB-6279	a -BENZOIN OXIME AR-100GM	100GM	1,942.20
PB-6280	a -BENZOIN OXIME AR-25GM	25GM	592.80
PB-6281	ACACIA (Confirms to IP) - 500GM	500GM	663.00
PB-6282	ACACIA (Confirms to IP) - 5KG	5KG	6,520.80
PB-6283	ACACIA (ENZYME FREE) AR - 500GM	500GM	1,248.00
PB-6284	ACENAPHTHENE FOR SYNTHESIS - 100GM	100GM	530.40
PB-6285	ACENAPHTHENE FOR SYNTHESIS - 500GM	500GM	1,872.00
PB-6286	ACES BUFFER - 100GM	100GM	6,099.60
PB-6287	ACES BUFFER - 5GM	5GM	553.80
PB-6288	ACES BUFFER -25GM	25GM	2,215.20
PB-6289	ACETAMIDE 99% - 500GM	500GM	834.60
PB-6290	ACETANILDE - 500GM	500GM	1,107.60
PB-6291	ACETATE BUFFER SOLUTION PH 4.6	500ML	249.60
PB-6292	ACETIC ACID FOR HPLC - 1LTR	1LTR	1,216.80
PB-6293	ACETIC ACID FOR HPLC -2.5LTR	2.5LTR	2,792.40
PB-6294	ACETIC ACID GLACIAL AR -2.5LTR	2.5LTR	1,466.40
PB-6295	ACETIC ACID GLACIAL AR -500ML	500ML	382.20
PB-6296	ACETIC ACID GLACIAL LR -500ML	500ML	273.00
PB-6297	ACETIC ACID GLACIAL LR-2.5LTR	2.5LTR	1,138.80
PB-6298	ACETO ORCEIN -100ML	100 ML	429.00
PB-6299	ACETONE AR - 500ML	500ML	429.00
PB-6300	ACETONE AR- 1LTR	1LTR	811.20
PB-6301	ACETONE AR- 2.5LTR	2.5LTR	1497.60
PB-6302	ACETONE FOR HPLC- 1LTR	1LTR	936.00
PB-6303	ACETONE FOR HPLC- 2.5LTR	2.5LTR	2106.00
PB-6304	ACETONE LR- 1LTR	1LTR	670.80
PB-6305	ACETONE LR- 2.5LTR	2.5LTR	1,310.40
PB-6306	ACETONE LR- 500ML	500ML	343.20
PB-6307	ACETONITRILE (Methyl Cyanide) LR - 2.5LTR	2.5LTR	2059.20
PB-6308	ACETONITRILE (Methyl Cyanide) LR - 500ML	500ML	483.60
PB-6309	ACETONITRILE AR - 2.5LTR	2.5LTR	2184.00
PB-6310	ACETONITRILE AR - 500ML	500ML	507.00
PB-6311	ACETONITRILE FOR HPLC - 2.5LTR	2.5LTR	2301.00
PB-6312	ACETONITRILE FOR HPLC- 1LTR	1LTR	982.80
PB-6313	ACETOPHENONE AR-2.5LTR	2.5LTR	4,578.60
PB-6314	ACETOPHENONE AR-500ML	500ML	1,209.00
PB-6315	ACETOPHENONE LR 99%-500ML	500ML	1,014.00

CODE	PRODUCT	PACKING	PRICE
PB-6316	ACETOPHENONE LR99%-2.5LTR	2.5LTR	4,297.80
PB-6317	ACETYL ACETONE AR FOR SYNTHESIS-250ML	250 ML	1138.80
PB-6318	ACETYL ACETONE AR FOR SYNTHESIS-500ML	500ML	2152.80
PB-6319	ACETYL ACETONE FOR SYNTHESIS - 500ML	500ML	2028.00
PB-6320	ACETYL ACETONE FOR SYNTHESIS- 2.5LTR	2.5LTR	7800.00
PB-6321	ACETYL ACETONE FOR SYNTHESIS-250ML	250 ML	1029.60
PB-6322	ACETYL CHLORIDE LR	500ML	663.00
PB-6323	ACETYL CHLORIDE LR	2.5LTR	3,010.80
PB-6324	ACETYL CHOLINE CHLORIDE AR-10GM	10GM	3,744.00
PB-6325	ACETYL CHOLINE CHLORIDE AR-25GM	25GM	8,182.20
PB-6326	ACRIDINE ORANGE FOR MICROSCOPICAL STAINING-10GM	10GM	1,872.00
PB-6327	ACRIDINE ORANGE FOR MICROSCOPICAL STAINING-25GM	25GM	4,648.80
PB-6328	ACRIFLAVIN FOR BIOCHEMISTRY-100GM	100GM	6,723.60
PB-6329	ACRIFLAVIN FOR BIOCHEMISTRY-250GM	250GM	13,657.80
PB-6330	ACRIFLAVIN FOR BIOCHEMISTRY-25GM	25GM	2,152.80
PB-6331	ACRIFLAVIN FOR BIOCHEMISTRY-5GM	5 GM	460.20
PB-6332	ACRYLAMIDE FOR SYNTHESIS- 500GM	500GM	858.00
PB-6333	ACRYLIC ACID LR99%	500ML	834.60
PB-6334	ACRYLIC ACID LR99%	2.5LTR	3,744.00
PB-6335	ACRYLONITRILE (STABILIZED) LR-500ML	500ML	663.00
PB-6336	ACRYLONITRILE (STABILIZED)LR -2.5LTR	2.5LTR	3,049.80
PB-6337	ACTIDIONE AR (Cycloheximide)-1GM	1GM	4,095.00
PB-6338	ACTIDIONE AR (Cycloheximide)-5GM	5GM	16,434.60
PB-6339	ADA BUFFER - -25GM	25GM	803.40
PB-6340	ADA BUFFER -100GM	100GM	3,151.20
PB-6341	ADENINE FOR BIOCHEMISTRY-25GM	25GM	1,458.60
PB-6342	ADENINE FOR BIOCHEMISTRY-5GM	5GM	460.20
PB-6343	ADENINE SULPHATE AR-100GM	100GM	7,488.00
PB-6344	ADENINE SULPHATE AR-10GM	10GM	787.80
PB-6345	ADENOSINE FOR BIOCHEMISTRY-25GM	25GM	1,638.00
PB-6346	ADENOSINE FOR BIOCHEMISTRY-5GM	5 GM	390.00
PB-6347	ADENOSINE-5-MONOPHOSPHORIC ACID DISODIUM SALT-1GM	1GM	358.80
PB-6348	ADENOSINE-5-MONOPHOSPHORIC ACID DISODIUM SALT-25GM	25GM	3,400.80
PB-6349	ADENOSINE-5-MONOPHOSPHORIC ACID DISODIUM SALT-5GM	5GM	1,014.00
PB-6350	ADENOSINE-5-TRIPHOSPHORIC ACID DISODIUM SALT-1GM	1GM	335.40
PB-6351	ADENOSINE-5-TRIPHOSPHORIC ACID DISODIUM SALT-25GM	25GM	5,756.40
PB-6352	ADENOSINE-5-TRIPHOSPHORIC ACID DISODIUM SALT-5GM	5GM	1,357.20
PB-6353	ADIPIC ACID PURE-500GM	500GM	655.20
PB-6354	AESCULIN- 25GM	25GM	8,182.20
PB-6355	AESCULIN-5GM	5GM	1,942.20
PB-6356	AGAR AGAR POWDER FOR TISSUE CULTURE	500GM	6318.00
PB-6357	AGAR AGAR POWDER NO.1 FOR BACTERIOLOGY-250GM	250GM	2964.00
PB-6358	AGAR AGAR POWDER NO.1 FOR BACTERIOLOGY-500GM	500GM	6084.00
PB-6359	AGAROSE DNA GRADE LOW MELTING-100GM	100GM	59,342.40
PB-6360	AGAROSE DNA GRADE LOW MELTING-10GM	10GM	7,207.20
PB-6361	AGAROSE DNA GRADE LOW MELTING-5GM	5GM	3,736.20
PB-6362	AGAROSE FOR ELECTROPHORESIS (H) -10GM	10GM	1,248.00
PB-6363	AGAROSE FOR ELECTROPHORESIS (H) -25GM	25GM	2,917.20
PB-6364	AGAROSE FOR ELECTROPHORESIS (L)-10GM	10GM	1,388.40
PB-6365	AGAROSE FOR ELECTROPHORESIS (L)-25GM	25GM	3,190.20
PB-6366	AGAROSE FOR ELECTROPHORESIS (M)-10GM	10GM	1,528.80
PB-6367	AGAROSE FOR ELECTROPHORESIS (M)-25GM	25GM	3,330.60
PB-6368	a-KETOGLUTARIC ACID PURISS -100GM	100GM	2886.00
PB-6369	a-KETOGLUTARIC ACID PURISS -25GM	25GM	904.80
PB-6370	ALAR(B-9) AR-1GM	1GM	936.00
PB-6371	ALAR(B-9) AR-5GM	5GM	4,126.20

CODE	PRODUCT	PACKING	PRICE
PB-6372	ALBERT STAIN A SOLUTION-125ML	125ML	132.60
PB-6373	ALBERT STAIN B SOLUTION-125ML	125ML	132.60
PB-6374	ALCIAN BLUE 8GX FOR MICROSCOPY C.I. No.74240	5GM	3588.00
PB-6375	ALCIAN BLUE 8GX FOR MICROSCOPY C.I. No.74240	10GM	7098.00
PB-6376	ALCIAN BLUE 8GX FOR MICROSCOPY C.I. No.74240	25GM	18720.00
PB-6377	ALGINIC ACID (PHARMA GRADE)- 500GM	500GM	1,872.00
PB-6378	ALGINIC ACID (PHARMA GRADE)-5KG	5KG	16,364.40
PB-6379	ALIZARINE AR C.I. No. 58000- 25GM	25GM	530.40
PB-6380	ALIZARINE AR C.I. No. 58001- 100GM	100GM	2028.00
PB-6381	ALIZARINE COMPLEXON - 1GM	1GM	1,279.20
PB-6382	ALIZARINE COMPLEXON - 5 GM	5 GM	4,024.80
PB-6383	ALIZARINE RED S AR - 25GM	25GM	764.40
PB-6384	ALIZARINE RED S AR -100GM	100GM	2340.00
PB-6385	ALIZARINE RED S LR- 100GM	100GM	2223.00
PB-6386	ALIZARINE RED S LR- 25GM	25GM	733.20
PB-6387	ALKALI BLUE 6B INDICATOR- 25GM	25GM	4,578.60
PB-6388	ALKALI BLUE 6B INDICATOR- 5GM	5GM	1,138.80
PB-6389	ALLOXAN (HYDRATE) 98%- 25GM	25GM	904.80
PB-6390	ALLYL ALCOHOL 99% FOR SYNTHESIS (2-PROPENE-1-OL) -2.5LTR	2.5LTR	4,297.80
PB-6391	ALLYL ALCOHOL 99% FOR SYNTHESIS (2-PROPENE-1-OL)-500ML	500ML	928.20
PB-6392	ALUMINIUM (FINE) POWDER (200 MESH) - 500GM	500GM	795.60
PB-6393	ALUMINIUM (FINE) POWDER (200 MESH) -5KG	5KG	7,488.00
PB-6394	ALUMINIUM AMMONIUM SULPHATE DODECAHYDRATE -500GM	500GM	280.80
PB-6395	ALUMINIUM CHLORIDE ANHYDROUS (CRYSTALS)-500GM	500GM	522.60
PB-6396	ALUMINIUM CHLORIDE ANHYDROUS (POWDER)-500GM	500GM	405.60
PB-6397	ALUMINIUM FOIL 99%	500GM	1,443.00
PB-6398	ALUMINIUM FOIL AR 99.9%	500GM	6,793.80
PB-6399	ALUMINIUM HYDROXIDE GEL-250GM	250GM	319.80
PB-6400	ALUMINIUM HYDROXIDE GEL-500GM	500GM	577.20
PB-6401	ALUMINIUM NITRATE -500GM	500GM	280.80
PB-6402	ALUMINIUM OXIDE ACTIVE (ACIDIC)-500GM	500GM	436.80
PB-6403	ALUMINIUM OXIDE ACTIVE (BASIC)-500GM	500GM	436.80
PB-6404	ALUMINIUM OXIDE ACTIVE (NETUTRAL) -500GM	500GM	460.20
PB-6405	ALUMINIUM OXIDE G (NEUTRAL) -500GM	500GM	787.80
PB-6406	ALUMINIUM POTASSIUM SULPHATE AR -2.5KG	2.5KG	1,591.20
PB-6407	ALUMINIUM POTASSIUM SULPHATE AR -500GM	500GM	390.00
PB-6408	ALUMINIUM POTASSIUM SULPHATE LR- 2.5KG	2.5KG	1,216.80
PB-6409	ALUMINIUM POTASSIUM SULPHATE LR-500GM	500GM	288.60
PB-6410	ALUMINIUM STEARATE LR - 1KG	1KG	585.00
PB-6411	ALUMINIUM SULPHATE AR - 500GM	500GM	249.60
PB-6412	ALUMINIUM SULPHATE PURIFIED -500GM	500GM	202.80
PB-6413	ALUMINON AR -25GM	25GM	678.60
PB-6414	ALUMINON AR-10GM	10GM	288.60
PB-6415	AMARANTH - 25GM	25GM	249.60
PB-6416	AMBERLITE IR 120 NA + FORM - 500GM	500GM	842.40
PB-6417	AMBERLITE IR 400 CL- FORM- 500GM	500GM	1,123.20
PB-6418	AMIDO BLACK 10B C.I. NO. 20470 - 25GM	25GM	218.40
PB-6419	AMIDO BLACK 10B C.I. NO. 20471- 100GM	100GM	717.60
PB-6420	AMMONIA BUFFER SOLUTION - 500ML	500ML	234.00
PB-6421	AMMONIA SOLUTION 0.04%-500ML	500ML	112.32
PB-6422	AMMONIA SOLUTION 25% LR- 1LTR	1LTR	304.20
PB-6423	AMMONIA SOLUTION 25% LR- 2.5LTR	2.5LTR	842.40
PB-6424	AMMONIA SOLUTION 25% LR- 500ML	500ML	218.40
PB-6425	AMMONIA SOLUTION 25% LR- 5LTR	5LTR	1248.00
PB-6426	AMMONIA SOLUTION AR 25% -2.5LTR	2.5LTR	975.00
PB-6427	AMMONIA SOLUTION AR 25% -500ML	500ML	241.80

CODE	PRODUCT	PACKING	PRICE
PB-6428	AMMONIA SOLUTION AR 25% -5LTR	5LTR	1357.20
PB-6429	AMMONIA SOLUTION AR 25%-1LTR	1LTR	390.00
PB-6430	AMMONIUM ACETATE AR-500GM	500GM	460.20
PB-6431	AMMONIUM ACETATE LR-500GM	500GM	374.40
PB-6432	AMMONIUM ADIPATE PURIFIED 99%- 500GM	500GM	600.60
PB-6433	AMMONIUM BICARBONATE - 5KG	5KG	1,583.40
PB-6434	AMMONIUM BICARBONATE- 500GM	500GM	210.60
PB-6435	AMMONIUM BIFLUORIDE LR- 2.5KG	2.5KG	2,355.60
PB-6436	AMMONIUM BIFLUORIDE LR- 500GM	500GM	600.60
PB-6437	AMMONIUM BROMIDE- 500GM	500GM	1,014.00
PB-6438	AMMONIUM BROMIDE AR - 500GM	500GM	1,076.40
PB-6439	AMMONIUM CARBONATE AR- 500GM	500GM	444.60
PB-6440	AMMONIUM CARBONATE LR- 500GM	500GM	304.20
PB-6441	AMMONIUM CERIC NITRATE 0.05 N VOLUMETRIC SOLUTION (N/20)	500ML	522.60
PB-6442	AMMONIUM CERIC NITRATE AR-100GM	100GM	1,638.00
PB-6443	AMMONIUM CERIC NITRATE-100GM	100GM	1,357.20
PB-6444	AMMONIUM CERIC SULPHATE AR -100GM	100GM	2,028.00
PB-6445	AMMONIUM CERIC SULPHATE AR -500GM	500GM	8,868.60
PB-6446	AMMONIUM CERIC SULPHATE LR -100GM	100GM	1,622.40
PB-6447	AMMONIUM CERIC SULPHATE LR -500GM	500GM	6,864.00
PB-6448	AMMONIUM CHLORIDE AR -500GM	500GM	335.40
PB-6449	AMMONIUM CHLORIDE LR -500GM	500GM	304.20
PB-6450	AMMONIUM CHLORIDE LR -5KG	5KG	2,152.80
PB-6451	AMMONIUM CHLORIDE LR-1KG	1KG	499.20
PB-6452	AMMONIUM DICHROMATE AR -500GM	500GM	1,138.80
PB-6453	AMMONIUM DICHROMATE LR-500GM	500GM	1,068.60
PB-6454	AMMONIUM DICHROMATE LR-5KG	5KG	9,843.60
PB-6455	AMMONIUM DIHYDROGEN ORTHOPHOSPHATE AR -500GM	500GM	748.80
PB-6456	AMMONIUM DIHYDROGEN ORTHOPHOSPHATE LR-500GM	500GM	592.80
PB-6457	AMMONIUM FERRIC CITRATE (BROWN) -500GM	500GM	444.60
PB-6458	AMMONIUM FERRIC SULPHATE AR (Dodeca)-500GM	500GM	499.20
PB-6459	AMMONIUM FERRIC SULPHATE E.P.(Dodeca)-500GM	500GM	444.60
PB-6460	AMMONIUM FERROUS SULPHATE AR (Hexa)-500GM	500GM	460.20
PB-6461	AMMONIUM FERROUS SULPHATE LR (Hexa)-1KG	1KG	460.20
PB-6462	AMMONIUM FERROUS SULPHATE LR (Hexa)-500GM	500GM	249.60
PB-6463	AMMONIUM FERROUS SULPHATE LR (Hexa)-5KG	5KG	1,692.60
PB-6464	AMMONIUM FLUORIDE AR - 250GM	250GM	2,425.80
PB-6465	AMMONIUM FLUORIDE AR -500GM	500GM	4,508.40
PB-6466	AMMONIUM FLUORIDE LR-500GM	500GM	998.40
PB-6467	AMMONIUM FORMATE LR - 500GM	500GM	514.80
PB-6468	AMMONIUM FORMATE LR-250GM	250GM	335.40
PB-6469	AMMONIUM IODIDE AR	250GM	9,562.80
PB-6470	AMMONIUM IODIDE AR-50GM	50GM	2,355.60
PB-6471	AMMONIUM IODIDE LR	100GM	3,603.60
PB-6472	AMMONIUM IODIDE LR	250GM	8,182.20
PB-6473	AMMONIUM METAVANADATE AR-100GM	100GM	1,318.20
PB-6474	AMMONIUM METAVANADATE AR-500GM	500GM	5,959.20
PB-6475	AMMONIUM METAVANADATE LR-100GM	100GM	1,138.80
PB-6476	AMMONIUM METAVANADATE LR-500GM	500GM	5,413.20
PB-6477	AMMONIUM MOLYBDATE ACS	500GM	6,793.80
PB-6478	AMMONIUM MOLYBDATE ACS	100GM	1,801.80
PB-6479	AMMONIUM MOLYBDATE AR -100GM	100GM	1,731.60
PB-6480	AMMONIUM MOLYBDATE AR-1KG	1KG	13,033.80
PB-6481	AMMONIUM MOLYBDATE AR-500GM	500GM	6,793.80
PB-6482	AMMONIUM MOLYBDATE LR -100GM	100GM	1,357.20
PB-6483	AMMONIUM MOLYBDATE LR -500GM	500GM	6,037.20

CODE	PRODUCT	PACKING	PRICE
PB-6484	AMMONIUM MOLYBDATE LR-250GM	250GM	3,120.00
PB-6485	AMMONIUM OXALATE AR -500GM	500GM	553.80
PB-6486	AMMONIUM OXALATE PURIFIED - 500GM	500GM	499.20
PB-6487	AMMONIUM PERSULPHATE AR - 500GM	500GM	561.60
PB-6488	AMMONIUM PERSULPHATE LR -5KG	5KG	4,056.00
PB-6489	AMMONIUM PERSULPHATE LR-500GM	500GM	530.40
PB-6490	AMMONIUM PURPURATE AR (MUREXIDE)-25GM	25GM	1,466.40
PB-6491	AMMONIUM PURPURATE AR (MUREXIDE)-5GM	5GM	483.60
PB-6492	AMMONIUM PURPURATE LR (MUREXIDE)-25GM	25GM	1,357.20
PB-6493	AMMONIUM PURPURATE LR (MUREXIDE)-5GM	5GM	468.00
PB-6494	AMMONIUM SULFAMATE -500GM	500GM	592.80
PB-6495	AMMONIUM SULPHATE AR -500GM	500GM	249.60
PB-6496	AMMONIUM SULPHATE AR -5KG	5KG	2,074.80
PB-6497	AMMONIUM SULPHATE LR- 500GM	500GM	218.40
PB-6498	AMMONIUM SULPHATE LR -5KG	5KG	1,333.80
PB-6499	AMMONIUM SULPHIDE SOLUTION 20%	500ML	397.80
PB-6500	AMMONIUM TARTRATE LR FOR HAIRDYE-500GM	500GM	1,450.80
PB-6501	AMMONIUM THIOCYANATE AR -500GM	500GM	928.20
PB-6502	AMMONIUM THIOCYANATE LR -500GM	500GM	678.60
PB-6503	AMMONIUM THIOSULPHATE LR - 1KG	1KG	530.40
PB-6504	AMMONIUM THIOSULPHATE LR-5KG	5KG	2,355.60
PB-6505	ANETHOL FOR SYNTHESIS 99%	500ML	3,400.80
PB-6506	ANETHOL FOR SYNTHESIS 99%	2.5LTR	15,256.80
PB-6507	ANILINE AR 99.5% 2.5LTR	2.5LTR	3,330.60
PB-6508	ANILINE AR 99.5% 500ML	500ML	733.20
PB-6509	ANILINE BLUE SPIRIT SOLUBLE FOR MICROSCOPY-100GM	100GM	4056.00
PB-6510	ANILINE BLUE SPIRIT SOLUBLE FOR MICROSCOPY-25GM	25GM	1716.00
PB-6511	ANILINE BLUE W/S-100GM	100GM	2574.00
PB-6512	ANILINE BLUE W/S-25GM	25GM	1248.00
PB-6513	ANILINE HYDROCHLORIDE	250-GM	787.80
PB-6514	ANILINE HYDROCHLORIDE	500-GM	1,388.40
PB-6515	ANILINE LR 99%-2.5LTR	2.5LTR	2,917.20
PB-6516	ANILINE LR 99%-500ML	500ML	624.00
PB-6517	ANILINE SULPHATE	250GM	873.60
PB-6518	ANILINE SULPHATE	500GM	1,528.80
PB-6519	ANISALDEHYDE 98% LR (4-Methoxy Benzaldehyde)	250 ML	1,177.80
PB-6520	ANISALDEHYDE 98% LR (4-Methoxy Benzaldehyde)	500ML	2,215.20
PB-6521	ANISALDEHYDE 98% LR (4-Methoxy Benzaldehyde)	2.5LTR	10,951.20
PB-6522	ANISOLE FOR SYNTHESIS	500ML	967.20
PB-6523	ANISOLE FOR SYNTHESIS	2.5LTR	4,368.00
PB-6524	ANTHARACENE PURE -100GM	100GM	1,591.20
PB-6525	ANTHARACENE PURE-500GM	500GM	6,380.40
PB-6526	ANTHRAQUINONE FOR SYNTHESIS-500GM	500GM	1,263.60
PB-6527	ANTHRONE AR-10GM	10GM	530.40
PB-6528	ANTHRONE AR-25GM	25GM	1,014.00
PB-6529	ANTHRONE FOR SYNTHESIS-25GM	25GM	858.00
PB-6530	ANTIMONY (III) CHLORIDE LR -500GM	500GM	3,190.20
PB-6531	ANTIMONY (III) CHLORIDE LR-250GM	250GM	1,692.60
PB-6532	ANTIMONY (METAL) POWDER-500GM	500GM	5,132.40
PB-6533	ANTIMONY POTASSIUM TARTARATE AR -100GM	100GM	655.20
PB-6534	ANTIMONY POTASSIUM TARTARATE AR-500GM	500GM	2,839.20
PB-6535	ANTIMONY POTASSIUM TARTARATE LR -500GM	500GM	2,496.00
PB-6536	ANTIMONY POTASSIUM TARTARATE LR-250GM	250GM	1,318.20
PB-6537	ANTIMONY SULPHIDE BLACK -500GM	500GM	3,400.80
PB-6538	ANTIMONY SULPHIDE GLODEN-500GM	500GM	4,024.80
PB-6539	ANTIMONY TRIOXIDE -500GM	500GM	2,496.00

CODE	PRODUCT	PACKING	PRICE
PB-6540	ANTIMONY(III) CHLORIDE AR -250GM	250GM	2,012.40
PB-6541	ANTIMONY(III) CHLORIDE AR -500GM	500GM	3,603.60
PB-6542	ARSENAZO I AR - 5GM	5 GM	4,438.20
PB-6543	ARSENAZO I AR -1GM	1GM	928.20
PB-6544	ARSENAZO III AR-5GM	5 GM	6,661.20
PB-6545	ATROPINE SULPHATE AR - 5GM	5GM	1,528.80
PB-6546	ATROPINE SULPHATE AR 25GM	25GM	6,793.80
PB-6547	AURAMIN FOR MICROSCOPY- 100GM	100GM	663.00
PB-6548	AURAMIN FOR MICROSCOPY- 25GM	25GM	280.80
PB-6549	AZO-BIS-ISO-BUTYRIONITRILE- 500GM	500GM	5,959.20
PB-6550	AZO-BIS-ISO-BUTYRIONITRILE-100GM	100GM	1,177.80
PB-6551	AZOCARMINE G for Histology- 25GM	25GM	2,449.20
PB-6552	AZO-METHINE H MONOSODIUM SALT HYDRATE 1GM	1GM	1,216.80
PB-6553	AZO-METHINE H MONOSODIUM SALT HYDRATE- 5GM	5GM	4,851.60
PB-6554	AZUR A - 5GM	5GM	249.60
PB-6555	AZUR A -10GM	10GM	390.00
PB-6556	AZUR A -25GM	25GM	834.60
PB-6557	AZUR B - 5GM	5GM	460.20
PB-6558	AZUR B- 25GM	25GM	1,107.60
PB-6559	AZUR II FOR MICROSCOPY- 10GM	10GM	343.20
PB-6560	AZUR II FOR MICROSCOPY- 25GM	25GM	624.00
PB-6561	b-ALANINE FOR BIOCHEMISTRY-100GM	100GM	1,084.20
PB-6562	b-ALANINE FOR BIOCHEMISTRY-25GM	25GM	265.20
PB-6563	BALSAM CANADA (NATURAL) FOR MICROSCOPY (COLOURLESS)-500GM	500GM	3,260.40
PB-6564	BALSAM CANADA (SYNTHETIC)-500GM	500GM	1,661.40
PB-6565	BARBITURIC ACID AR-100GM	100GM	1,318.20
PB-6566	BARBITURIC ACID AR-25GM	25GM	592.80
PB-6567	BARBITURIC ACID FOR SYNTHESIS-100GM	100GM	858.00
PB-6568	BARBITURIC ACID FOR SYNTHESIS-25GM	25GM	468.00
PB-6569	BARBITURIC ACID FOR SYNTHESIS-500GM	500GM	4056.00
PB-6570	BARFOAD'S REAGENT -500ML	500ML	663.00
PB-6571	BARIUM ACETATE LR-500GM	500GM	889.20
PB-6572	BARIUM ACETATE AR-500GM	500GM	1,076.40
PB-6573	BARIUM BROMIDE -500GM	500GM	1,684.80
PB-6574	BARIUM CARBONATE AR-500GM	500GM	1,326.00
PB-6575	BARIUM CARBONATE LR-500GM	500GM	702.00
PB-6576	BARIUM CARBONATE LR-5KG	5KG	6,240.00
PB-6577	BARIUM CHLORIDE (DIHYDRATED) LR-500GM	500GM	358.80
PB-6578	BARIUM CHLORIDE (DIHYDRATED) LR-5KG	5KG	3,120.00
PB-6579	BARIUM CHLORIDE DIHYDRATED AR-500GM	500GM	429.00
PB-6580	BARIUM CHROMATE	500GM	1950.00
PB-6581	BARIUM CHROMATE AR	100GM	624.00
PB-6582	BARIUM CHROMATE AR	500GM	2262.00
PB-6583	BARIUM DIPHENYLAMINE SULPHONATE AR-25GM	25GM	1,138.80
PB-6584	BARIUM DIPHENYLAMINE SULPHONATE AR-5GM	5GM	390.00
PB-6585	BARIUM HYDROXIDE AR (OCTAHYDRATE)-500GM	500GM	3088.80
PB-6586	BARIUM HYDROXIDE LR (OCTAHYDRATE)-500GM	500GM	405.60
PB-6587	BARIUM HYDROXIDE LR (OCTAHYDRATE)-5KG	5KG	3588.00
PB-6588	BARIUM NITRATE AR-500GM	500GM	460.20
PB-6589	BARIUM NITRATE LR-500GM	500GM	390.00
PB-6590	BARIUM NITRATE LR-5KG	5KG	3,744.00
PB-6591	BARIUM PERCHLORATE ANHYDROUS AR-250GM	250GM	8,595.60
PB-6592	BARIUM PERCHLORATE LR (AHYDROUS)-250GM	250GM	7,901.40
PB-6593	BARIUM PEROXIDE-500GM	500GM	998.40
PB-6594	BARIUM STEARATE-1KG	1KG	538.20
PB-6595	BARIUM SULPHATE LR-500GM	500GM	421.20

CODE	PRODUCT	PACKING	PRICE
PB-6596	BATHOPHENANTHROLINE AR-100MG	100MG	2,909.40
PB-6597	BATHOPHENANTHROLINE AR-1GM	1GM	21,910.20
PB-6598	BATHOPHENANTHROLINE AR-250MG	250MG	6,520.80
PB-6599	BATHOPHENANTHROLINE DISULPHONIC ACID DISODIUM SALT AR-250MG	250MG	6,169.80
PB-6600	b-CYCLODEXTRIN	100GM	780.00
PB-6601	b-CYCLODEXTRIN	500GM	3666.00
PB-6602	BEEF EXTRACT POWDER BACTERIOLOGICAL GRADE-500GM	500GM	1,661.40
PB-6603	BEES WAX PURE (WHITE) FOR HISTOLOGY-500GM	500GM	1,107.60
PB-6604	BENEDICT'S REAGENT (QUALITATIVE)-500ML	500ML	218.40
PB-6605	BENEDICT'S REAGENT (QUALITATIVE)-5LTR	5LTR	1,146.60
PB-6606	BENEDICT'S REAGENT (QUANTITATIVE)-500ML	500ML	358.80
PB-6607	BENTONITE POWDER (CONFIRMING TO BP STANDARD)-500GM	500GM	374.40
PB-6608	BENZALDEHYDE AR 99%	500ML	858.00
PB-6609	BENZALDEHYDE AR 99%	2.5LTR	3,822.00
PB-6610	BENZALDEHYDE LR -500ML	500ML	717.60
PB-6611	BENZALDEHYDE LR -2.5LTR	2.5LTR	3,042.00
PB-6612	BENZALKONIUM CHLORIDE 50% SOLUTION PURE-500ML	500ML	530.40
PB-6613	BENZALKONIUM CHLORIDE 50% SOLUTION PURE-5LTR	5LTR	3,900.00
PB-6614	BENZAMIDE FOR SYNTHESIS -500GM	500GM	1,357.20
PB-6615	BENZANILIDE FOR SYNTHESIS-100GM	100GM	936.00
PB-6616	BENZANILIDE FOR SYNTHESIS-500GM	500GM	3978.00
PB-6617	BENZENE AR-2.5LTR	2.5LTR	1,833.00
PB-6618	BENZENE AR-500ML	500ML	483.60
PB-6619	BENZENE LR-2.5LTR	2.5LTR	1,591.20
PB-6620	BENZENE LR-500ML	500ML	421.20
PB-6621	BENZIL FOR SYNTHESIS-1KG	1KG	3,533.40
PB-6622	BENZIL FOR SYNTHESIS-250GM	250GM	1,037.40
PB-6623	BENZIMIDAZOLE FOR SYNTHESIS -500GM	500GM	3,166.80
PB-6624	BENZIMIDAZOLE FOR SYNTHESIS -100GM	100GM	561.60
PB-6625	BENZOIC ACID AR-500GM	500GM	943.80
PB-6626	BENZOIC ACID AR-5KG	5KG	8,182.20
PB-6627	BENZOIC ACID LR-500GM	500GM	514.80
PB-6628	BENZOIC ACID LR-5KG	5KG	4,789.20
PB-6629	BENZOIC ANHYDRIDE -100GM	100GM	2,652.00
PB-6630	BENZOIC ANHYDRIDE -500GM	500GM	9,360.00
PB-6631	BENZOIN FOR SYNTHESIS-100GM	100GM	663.00
PB-6632	BENZOIN FOR SYNTHESIS-250GM	250GM	1,138.80
PB-6633	BENZONITRILE LR FOR SYNTHESIS (Phenyl Cyanide)	500ML	2,425.80
PB-6634	BENZOPHENONE -500GM	500GM	1,037.40
PB-6635	BENZOYL CHLORIDE AR-2.5LTR	2.5LTR	4,165.20
PB-6636	BENZOYL CHLORIDE AR-500ML	500ML	1,068.60
PB-6637	BENZOYL CHLORIDE LR-2.5LTR	2.5LTR	3,822.00
PB-6638	BENZOYL CHLORIDE LR-500ML	500ML	928.20
PB-6639	BENZOYL PEROXIDE (moistured with 25% water)-500GM	500GM	928.20
PB-6640	BENZYL ALCOHOL AR-2.5LTR	2.5LTR	3,400.80
PB-6641	BENZYL ALCOHOL AR-500ML	500ML	873.60
PB-6642	BENZYL ALCOHOL LR-2.5LTR	2.5LTR	2,698.80
PB-6643	BENZYL ALCOHOL LR-500ML	500ML	733.20
PB-6644	BENZYL BENZOATE (Confirming to BP)	500ML	858.00
PB-6645	BENZYL BENZOATE (Confirming to BP)	2.5LTR	4,024.80
PB-6646	BENZYL TRIBUTYL AMMONIUM CHLORIDE-100GM	100GM	569.40
PB-6647	BENZYL TRIBUTYL AMMONIUM CHLORIDE-500GM	500GM	2,386.80
PB-6648	BENZYL TRIETHYL AMMONIUM CHLORIDE -500GM	500GM	762.84
PB-6649	BENZYL TRIMETHYL AMMONIUM CHLORIDE FOR SYNTHESIS-500GM	500GM	1,661.40
PB-6650	BENZYLAMINE LR 99%	500ML	1,357.20
PB-6651	BENZYLAMINE LR 99%	2.5LTR	5,959.20

CODE	PRODUCT	PACKING	PRICE
PB-6652	BES BUFFER FOR BIOCHEMISTRY-100GM	100GM	5,756.40
PB-6653	BES BUFFER FOR BIOCHEMISTRY-25GM	25GM	1,497.60
PB-6654	BIAL'S REAGENT(ORCINOL REAGENT)	250ML	530.40
PB-6655	BICINE 99%	25GM	1,372.80
PB-6656	BICINE 99%	100GM	4,508.40
PB-6657	BILE SALT FOR BACTERIOLOGY-100GM	100GM	2652.00
PB-6658	BILE SALT FOR BACTERIOLOGY-500GM	500GM	10452.00
PB-6659	BILIRUBIN AR-100MG	100MG	1,138.80
PB-6660	BILIRUBIN AR-1GM	1GM	8,876.40
PB-6661	BIPHENYL FOR SYNTESIS-100GM	100GM	514.80
PB-6662	BIPHENYL FOR SYNTESIS-1KG	1KG	3,190.20
PB-6663	BISMARCK BROWN R C.I. NO. 21010 100GM	100GM	624.00
PB-6664	BISMARCK BROWN R C.I. NO. 21010 25GM	25GM	218.40
PB-6665	BISMARCK BROWN Y (G)C.I. NO.21000-25GM	25GM	226.20
PB-6666	BISMARCK BROWN Y (G)C.I. NO.21001-100GM	100GM	639.60
PB-6667	BISMUTH AMMONIUM CITRATE-100GM	100GM	1,450.80
PB-6668	BISMUTH (METAL) GRANULAR -100GM	100GM	1,450.80
PB-6669	BISMUTH (METAL) GRANULAR -500GM	500GM	6,864.00
PB-6670	BISMUTH (METAL) POWDER -100GM	100GM	2,012.40
PB-6671	BISMUTH CARBONATE-100GM	100GM	1,599.00
PB-6672	BISMUTH CARBONATE-500GM	500GM	7,488.00
PB-6673	BISMUTH NITRATE AR (PENTAHYDRATE)-100GM	100GM	1,107.60
PB-6674	BISMUTH NITRATE AR (PENTAHYDRATE)-500GM	500GM	4,992.00
PB-6675	BISMUTH NITRATE (PENTAHYDRATE)-100GM	100GM	998.40
PB-6676	BISMUTH NITRATE (PENTAHYDRATE)-500GM	500GM	4,711.20
PB-6677	BISMUTH OXIDE -100GM	100GM	1,731.60
PB-6678	BISMUTH OXIDE -500GM	500GM	8,182.20
PB-6679	BISMUTH SUBNITRATE AR-100GM	100GM	2,074.80
PB-6680	BISMUTH SUBNITRATE AR-500GM	500GM	9,289.80
PB-6681	BISMUTH SUBNITRATE LR-100GM	100GM	1,591.20
PB-6682	BISMUTH SUBNITRATE LR-500GM	500GM	7,831.20
PB-6683	BISMUTH SULPHATE LR-250GM	250GM	3,463.20
PB-6684	BISMUTH SULPHATE LR-500GM	500GM	6,520.80
PB-6685	BIURET AR-100GM	100GM	8190.00
PB-6686	BIURET AR-25GM	25GM	2184.00
PB-6687	BIURET REAGENT-125ML	125ML	226.20
PB-6688	BLEACHING POWDER-500GM	500GM	218.40
PB-6689	BLUE TETRAZOLIUM FOR MICROSCOPY AR-1GM	1GM	2028.00
PB-6690	BLUE TETRAZOLIUM FOR MICROSCOPY AR-5GM	5GM	8892.00
PB-6691	BOP REAGENT (Peptide Coupling Reagent)-25GM	25GM	4,009.20
PB-6692	BOP REAGENT FOR SYNTHESIS	100GM	14,562.60
PB-6693	BOP REAGENT FOR SYNTHESIS-5GM	5GM	912.60
PB-6694	borax carmine (grenacher) alcoholic staining solution-125ML	125ML	358.80
PB-6695	borax carmine (grenacher) aqueous staining solution-125ML	125ML	304.20
PB-6696	BORAXCARMINE (GRENACHER)	25 GM	1,528.80
PB-6697	BORIC ACID AR-500GM	500GM	624.00
PB-6698	BORIC ACID GRANULAR-500GM	500GM	390.00
PB-6699	BORIC ACID GRANULAR-5KG	5KG	3,541.20
PB-6700	BORIC ACID LR (POWDER)-1KG	1KG	850.20
PB-6701	BORIC ACID LR (POWDER)-500GM	500GM	444.60
PB-6702	BORIC ACID LR (POWDER)-5KG	5KG	3,814.20
PB-6703	BOUIN'S FLUID-100ML	100ML	140.40
PB-6704	BOUIN'S FLUID-500ML	500ML	460.20
PB-6705	BOVINE ALBUMIN FRACTION V (POWDER)-100GM	100GM	19,133.40
PB-6706	BOVINE ALBUMIN FRACTION V (POWDER)-10GM	10GM	2,152.80
PB-6707	BOVINE ALBUMIN FRACTION V (POWDER)-5GM	5GM	1,357.20

CODE	PRODUCT	PACKING	PRICE
PB-6708	BOVINE ALBUMIN FRACTION V PROTEASE FREE-100GM	100GM	21,910.20
PB-6709	BOVINE ALBUMIN FRACTION V PROTEASE FREE-10GM	10GM	2,776.80
PB-6710	BRILLIANT CRESYL BLUE FOR MICROSCOPY-25GM	25GM	3,954.60
PB-6711	BRILLIANT CRESYL BLUE FOR MICROSCOPY-5GM	5GM	1,053.00
PB-6712	BRILLIANT CRESYL BLUE FOR SOLUTION (ALCOHOLIC)-100ML	100ML	390.00
PB-6713	BRILLIANT GREEN INDICATOR-100GM	100GM	663.00
PB-6714	BRILLIANT GREEN INDICATOR-25GM	25GM	234.00
PB-6715	BROMINE AR-250ML	250ML	2,496.00
PB-6716	BROMINE LR-5 X 20ML	5 X 20ML	1,318.20
PB-6717	BROMINE WATER-500ML	500ML	366.60
PB-6718	BROMOBENZENE LR 99%	250ML	834.60
PB-6719	BROMOBENZENE LR 99%	500ML	1,528.80
PB-6720	BROMOBENZENE LR 99%	2.5LTR	7,347.60
PB-6721	BROMOCRESOL GREEN INDICATOR AR-25GM	25GM	3,744.00
PB-6722	BROMOCRESOL GREEN INDICATOR AR-5GM	5GM	928.20
PB-6723	BROMOCRESOL GREEN INDICATOR SOLUTION-125ML	125ML	148.20
PB-6724	BROMOCRESOL PURPLE INDICATOR AR-25GM	25GM	1,209.00
PB-6725	BROMOCRESOL PURPLE INDICATOR AR-5GM	5GM	288.60
PB-6726	BROMOCRESOL PURPLE INDICATOR SOLUTION (0.04%)-125ML	125ML	148.20
PB-6727	BROMOFORM LR-250ML	250ML	4,149.60
PB-6728	BROMOFORM SPECIAL -250ML	250ML	4,438.20
PB-6729	BROMOPHENOL BLUE INDICATOR AR-25GM	25GM	998.40
PB-6730	BROMOPHENOL BLUE INDICATOR AR-5GM	5GM	249.60
PB-6731	BROMOPHENOL BLUE INDICATOR SOLUTION pH3.0-4.6-125ML	125ML	156.00
PB-6732	BROMOPYROGALLOL RED AR-1GM	1GM	904.80
PB-6733	BROMOPYROGALLOL RED AR-5GM	5 GM	3,603.60
PB-6734	BROMOTHYMOL BLUE INDICATOR AR-25GM	25GM	1,177.80
PB-6735	BROMOTHYMOL BLUE INDICATOR AR-5GM	5GM	358.80
PB-6736	BROMOTHYMOL BLUE INDICATOR SOLUTION (0.04% soln.)-125ML	125ML	148.20
PB-6737	BRUCINE AR (Reagent for bismuth)-10GM	10GM	943.80
PB-6738	BRUCINE AR (Reagent for bismuth)-25GM	25GM	2,152.80
PB-6739	BRUCINE SULPHATE PURISS-250GM	250GM	14,352.00
PB-6740	BRUCINE SULPHATE PURISS-25GM	25GM	1,450.80
PB-6741	BUFFER CAPSULES pH 4.0 -10TAB	10TAB	265.20
PB-6742	BUFFER CAPSULES pH 7.0 -10TAB	10TAB	265.20
PB-6743	BUFFER CAPSULES pH 9.2 -10TAB	10TAB	265.20
PB-6744	BUFFER SOLUTION pH 4.0 (PHTHALATE)-500ML	500ML	280.80
PB-6745	BUFFER SOLUTION pH 7.0 (PHOSPHATE)-500ML	500ML	280.80
PB-6746	BUFFER SOLUTION pH 9.0 (BORATE)-500ML	500ML	280.80
PB-6747	BUFFER SOLUTION pH 10.0-500ML	500ML	959.40
PB-6748	BUFFER SOLUTION pH2.0	500ML	967.20
PB-6749	BUTAN -2-OL AR (2-BUTYL ALCOHOL)	500ML	624.00
PB-6750	BUTAN -2-OL AR (2-BUTYL ALCOHOL)	2.5LTR	2,909.40
PB-6751	BUTAN -2-OL- LR 99% (SEC BUTYL ALCOHOL)	500ML	577.20
PB-6752	BUTAN -2-OL- LR 99% (SEC BUTYL ALCOHOL)	2.5LTR	2,636.40
PB-6753	BUTYLATED HYDROXY ANISOLE (B.H.A)-100GM	100GM	1,271.40
PB-6754	BUTYLATED HYDROXY ANISOLE (B.H.A)-500GM	500GM	4,017.00
PB-6755	BUTYLATED HYDROXY TOLUENE (B.H.T)-500GM	500GM	1,201.20
PB-6756	BUTYLATED HYDROXY TOLUENE (B.H.T)-5KG	5KG	10,257.00
PB-6757	CACOTHELINE 95% AR	5GM	998.40
PB-6758	CACOTHELINE 95% AR	25GM	4,711.20
PB-6759	CADMIUM (METAL) GRANULAR 99.9% AR-100GM	100GM	382.20
PB-6760	CADMIUM (METAL) GRANULAR 99.9% AR-500GM	500GM	1,708.20
PB-6761	CADMIUM ACETATE AR (DIHYDRATE)-100GM	100GM	663.00
PB-6762	CADMIUM ACETATE AR (DIHYDRATE)-250GM	250GM	1,201.20
PB-6763	CADMIUM ACETATE AR (DIHYDRATE)-500GM	500GM	2,285.40

CODE	PRODUCT	PACKING	PRICE
PB-6764	CADMIUM ACETATE LR (DIHYDRATE)-100GM	100GM	522.60
PB-6765	CADMIUM ACETATE LR (DIHYDRATE)-250GM	250GM	1,037.40
PB-6766	CADMIUM ACETATE LR (DIHYDRATE)-500GM	500GM	2,035.80
PB-6767	CADMIUM CARBONATE -100GM	100GM	429.00
PB-6768	CADMIUM CARBONATE -500GM	500GM	1,833.00
PB-6769	CADMIUM CHLORIDE (MONOHYDRATE)-100GM	100GM	577.20
PB-6770	CADMIUM CHLORIDE (MONOHYDRATE)-500GM	500GM	2,636.40
PB-6771	CADMIUM CHLORIDE AR (MONOHYDRATE)-100GM	100GM	678.60
PB-6772	CADMIUM CHLORIDE AR (MONOHYDRATE)-500GM	500GM	3,120.00
PB-6773	CADMIUM IODIDE-100GM	100GM	2,636.40
PB-6774	CADMIUM IODIDE-500GM	500GM	10,810.80
PB-6775	CADMIUM NITRATE (TETRAHYDRATE)-250GM	250GM	803.40
PB-6776	CADMIUM NITRATE (TETRAHYDRATE)-500GM	500GM	1,248.00
PB-6777	CADMIUM NITRATE AR (TETRAHYDRATE)-100GM	100GM	390.00
PB-6778	CADMIUM NITRATE AR (TETRAHYDRATE)-500GM	500GM	1,661.40
PB-6779	CADMIUM OXIDE -100GM	100GM	694.20
PB-6780	CADMIUM OXIDE -500GM	500GM	3,283.80
PB-6781	CADMIUM OXIDE AR-250GM	250GM	3,010.80
PB-6782	CADMIUM SULPHATE AR (OCTAHYDRATE)-100GM	100GM	717.60
PB-6783	CADMIUM SULPHATE AR (OCTAHYDRATE)-500GM	500GM	2,839.20
PB-6784	CADMIUM SULPHATE LR (OCTAHYDRATE)-100GM	100GM	577.20
PB-6785	CADMIUM SULPHATE LR (OCTAHYDRATE)-500GM	500GM	1,731.60
PB-6786	CAFFEIC ACID (3,4-Dihydroxycinnamic acid)	10GM	9,149.40
PB-6787	CAFFEIC ACID (3,4-Dihydroxycinnamic acid)	50GM	41,324.40
PB-6788	CAFFEINE AR (ANHYDROUS)-100GM	100GM	803.40
PB-6789	CAFFEINE AR (ANHYDROUS)-250GM	250GM	1,731.60
PB-6790	CAFFEINE PURE (ANHYDROUS)-100GM	100GM	694.20
PB-6791	CAFFEINE PURE (ANHYDROUS)-250GM	250GM	1,560.00
PB-6792	CAFFEINE PURE (ANHYDROUS)-500GM	500GM	2,839.20
PB-6793	CALAMINE-1KG	1KG	1,388.40
PB-6794	CALAMINE-500GM	500GM	787.80
PB-6795	CALCEINE INDICATOR AR (fluorecein complexone)-1GM	1GM	288.60
PB-6796	CALCEINE INDICATOR AR (fluorecein complexone)-5GM	5GM	1,068.60
PB-6797	CALCIUM ACETATE AR-500GM	500GM	826.80
PB-6798	CALCIUM ACETATE DRIED for soil test-500GM	500GM	624.00
PB-6799	CALCIUM CARBONATE LR-500GM	500GM	249.60
PB-6800	CALCIUM CARBONATE LR-5KG	5KG	1,887.60
PB-6801	CALCIUM CHLORIDE (DIHYDRATE) AR-500GM	500GM	858.00
PB-6802	CALCIUM CHLORIDE (DIHYDRATE) LR-500GM	500GM	280.80
PB-6803	CALCIUM CHLORIDE (DIHYDRATE) LR-5KG	5KG	1,942.20
PB-6804	CALCIUM CHLORIDE (FUSED)-2.5KG	2.5KG	1,037.40
PB-6805	CALCIUM CHLORIDE (FUSED)-500GM	500GM	249.60
PB-6806	CALCIUM CHLORIDE (FUSED)-5KG	5KG	1,872.00
PB-6807	CALCIUM FLUORIDE PURE-2.5KG	2.5KG	5,413.20
PB-6808	CALCIUM FLUORIDE PURE-500GM	500GM	1,248.00
PB-6809	CALCIUM HARDNESS INDICATOR-100TAB	100 TAB	202.80
PB-6810	CALCIUM HYDROGEN PHOSPHATE DIHYDRATE 98% LR	500GM	374.40
PB-6811	CALCIUM HYDROXIDE AR-500GM	500GM	858.00
PB-6812	CALCIUM HYDROXIDE PURE-500GM	500GM	218.40
PB-6813	CALCIUM LACTATE LR	250GM	351.00
PB-6814	CALCIUM LACTATE LR	1KG	1,326.00
PB-6815	CALCIUM NITRATE AR-500GM	500GM	343.20
PB-6816	CALCIUM NITRATE LR-500GM	500GM	218.40
PB-6817	CALCIUM OXIDE (LUMPS) LR -500GM	500GM	280.80
PB-6818	CALCIUM OXIDE LR (POWDER)-500GM	500GM	304.20
PB-6819	CALCIUM PROPIONATE 97%-1KG	1KG	943.80

CODE	PRODUCT	PACKING	PRICE
PB-6820	CALCIUM PROPIONATE 97%-500GM	500GM	507.00
PB-6821	CALCIUM STEARATE LR	500GM	577.20
PB-6822	CALCIUM STEARATE LR	5KG	4,921.80
PB-6823	CALCIUM SULPHATE (DIHYDRATE) AR-500GM	500GM	335.40
PB-6824	CALCIUM SULPHATE ANHYDROUS(DRIED)-500GM	500GM	319.80
PB-6825	CALCIUM SULPHATE(DIHYDRATE)-500GM	500GM	296.40
PB-6826	CALCIUM-D-PANTOTHENATE-10GM	10GM	156.00
PB-6827	CALCIUM-D-PANTOTHENATE-25GM	25GM	304.20
PB-6828	CALMAGITE INDICATOR AR-1GM	1GM	296.40
PB-6829	CALMAGITE INDICATOR AR-5GM	5GM	1,045.20
PB-6830	CAMPBOR (M.A.R.) Micro Analytical Reagent -500GM	500GM	2,215.20
PB-6831	CAMPBOR (M.A.R.) Micro Analytical Reagent -100GM	100GM	569.40
PB-6832	CAPRIC ACID (DECANOIC ACID) 98%-2.5LTR	2.5LTR	5,405.40
PB-6833	CAPRIC ACID (DECANOIC ACID) 98%-500ML	500ML	1,177.80
PB-6834	CAPRYLIC ACID LR 99%	500ML	1,731.60
PB-6835	CAPRYLIC ACID LR 99%	2.5LTR	8,174.40
PB-6836	CAPRYLIC ACID SODIUM SALT-1KG	1KG	6,099.60
PB-6837	CAPRYLIC ACID SODIUM SALT-250GM	250GM	1,825.20
PB-6838	CAPS BUFFER FOR BIOCHEMISTRY-100GM	100GM	3,712.80
PB-6839	CAPS BUFFER FOR BIOCHEMISTRY-25GM	25GM	1,216.80
PB-6840	CAPSO BUFFER FOR BIOCHEMISTRY-100GM	100GM	5,382.00
PB-6841	CAPSO BUFFER FOR BIOCHEMISTRY-25GM	25GM	1,638.00
PB-6842	CARBOL FUCHSIN DILUTE staining solution (ziehl Neelsen)-125ML	125ML	179.40
PB-6843	CARBOL FUCHSIN DILUTE staining solution (ziehl Neelsen)-500ML	500ML	561.60
PB-6844	CARBOL FUCHSIN POWDER-100GM	100GM	1,684.80
PB-6845	CARBOL FUCHSIN POWDER-25GM	25GM	468.00
PB-6846	CARBOL FUCHSIN STRONG staining solution (ziehl Neelsen)-125ML	125ML	187.20
PB-6847	CARBOL FUCHSIN STRONG staining solution (ziehl Neelsen)-500ML	500ML	631.80
PB-6848	CARBON TETRACHLORIDE AR-2.5LTR	2.5LTR	12,339.60
PB-6849	CARBON TETRACHLORIDE AR-500ML	500ML	2,698.80
PB-6850	CARBON TETRACHLORIDE HPLC	1LTR	5,272.80
PB-6851	CARBON TETRACHLORIDE LR-2.5LTR	2.5LTR	11,645.40
PB-6852	CARBON TETRACHLORIDE LR-500ML	500ML	2,566.20
PB-6853	CARBOPOL 934-1KG	1KG	7,878.00
PB-6854	CARBOPOL 934-500GM	500GM	4,290.00
PB-6855	CARBOPOL 940-1KG	1KG	8,080.80
PB-6856	CARBOPOL 940-500GM	500GM	4,524.00
PB-6857	CARBOXY METHYL CELLULOSE SODIUM SALT (HIGH VISC.) (500 - 600 CPS)-500GM	500GM	1,107.60
PB-6858	CARBOXY METHYL CELLULOSE SODIUM SALT (MED VISC.) (250 - 350 CPS)-500GM	500GM	1,107.60
PB-6859	CARMINE ACETO -100ML	100ML	1,146.60
PB-6860	CARMINE ACETO -250ML	250ML	2,355.60
PB-6861	CARMINE FOR MICROSCOPY-25GM	25GM	3,814.20
PB-6862	CARMINE FOR MICROSCOPY-5GM	5GM	787.80
PB-6863	CARMINIC ACID AR 98% For Microscopy C.I. No. 75470	1GM	3,260.40
PB-6864	CARMINIC ACID AR 98% For Microscopy C.I. No. 75470	5 GM	10,951.20
PB-6865	CASEIN -500GM	500GM	2,012.40
PB-6866	CASEIN HYDROLYSATE (TECHNICAL)-500GM	500GM	6,099.60
PB-6867	CASEIN SOLUBLE IN ALKALI-500GM	500GM	1,872.00
PB-6868	CASEIN VITAMIN FREE (also fat free)-500GM	500GM	2,012.40
PB-6869	CASTOR OIL (Refined)-2.5LTR	2.5LTR	2,425.80
PB-6870	CASTOR OIL (Refined)-500ML	500ML	530.40
PB-6871	CELESTIN BLUE for Microscopy C.I.No. 51050-5GM	5 GM	3,018.60
PB-6872	CELESTIN BLUE for Microscopy C.I.No. 51051-25GM	25GM	10,062.00
PB-6873	CELITE 545 FILTER AID-1KG	1KG	1,060.80
PB-6874	CELITE 545 FILTER AID-5KG	5KG	5,272.80

CODE	PRODUCT	PACKING	PRICE
PB-6875	CELLULOSE ACETATE-500GM	500GM	1,926.60
PB-6876	CELLULOSE MICROCRYSTALLINE FOR TLC-500GM	500GM	702.00
PB-6877	CELLULOSE POWDER FOR COLUMN CHROMATOGRAPHY-500GM	500GM	569.40
PB-6878	CERIC OXIDE AR	100GM	2,285.40
PB-6879	CERIC OXIDE AR	500GM	9,570.60
PB-6880	CERIC SULPHATE AR-100GM	100GM	4,024.80
PB-6881	CERIC SULPHATE AR-1KG	1KG	35,357.40
PB-6882	CEROUS NITRATE AR 99.9% (Cerium Nitrate hexahydrate)	100GM	1,372.80
PB-6883	CEROUS NITRATE AR 99.9% (Cerium Nitrate hexahydrate)	1KG	13,174.20
PB-6884	CESIUM ACETATE 99%-100GM	100GM	19,414.20
PB-6885	CESIUM ACETATE 99%-25GM	25GM	5,545.80
PB-6886	CESIUM BROMIDE >99.5% PURISS AR-10GM	10GM	2028.00
PB-6887	CESIUM BROMIDE >99.5% PURISS AR-50GM	50GM	9048.00
PB-6888	CESIUM CARBONATE FOR SYNTHESIS-100GM	100GM	6786.00
PB-6889	CESIUM CARBONATE FOR SYNTHESIS-25GM	25GM	2028.00
PB-6890	CESIUM CHLORIDE AR -100GM	100GM	8112.00
PB-6891	CESIUM CHLORIDE AR -25GM	25GM	2340.00
PB-6892	CESIUM CHLORIDE ULTRA PURE-10GM	10GM	2418.00
PB-6893	CESIUM CHLORIDE ULTRA PURE-50GM	50GM	8892.00
PB-6894	CESIUM FLUORIDE-100GM	100GM	8,182.20
PB-6895	CESIUM FLUORIDE-25GM	25GM	2,636.40
PB-6896	CESIUM HYDROXIDE -100GM	100GM	21,769.80
PB-6897	CESIUM HYDROXIDE -25GM	25GM	5,686.20
PB-6898	CESIUM IODIDE ULTRA PURE-10GM	10GM	2,979.60
PB-6899	CESIUM IODIDE ULTRA PURE-5GM	5GM	1,622.40
PB-6900	CESIUM IODIDE-10GM	10GM	1,591.20
PB-6901	CESIUM IODIDE-50GM	50GM	6,723.60
PB-6902	CESIUM NITRATE AR-10GM	10GM	1,872.00
PB-6903	CESIUM NITRATE AR-50GM	50GM	6,793.80
PB-6904	CESIUM SULPHATE AR-10GM	10GM	2340.00
PB-6905	CESIUM SULPHATE AR-50GM	50GM	11154.00
PB-6906	CETOSTEARYL ALCOHOL-500GM	500GM	522.60
PB-6907	CETYL ALCOHOL LR-500GM	500GM	748.80
PB-6908	CETYL PYRIDINIUM BROMIDE FOR SYNTHESIS-100GM	100GM	1,591.20
PB-6909	CETYL PYRIDINIUM BROMIDE FOR SYNTHESIS-250GM	250GM	2,152.80
PB-6910	CETYL PYRIDINIUM CHLORIDE FOR SYNTHESIS 98%-100GM	100GM	702.00
PB-6911	CETYL PYRIDINIUM CHLORIDE FOR SYNTHESIS 98%-500GM	500GM	2,636.40
PB-6912	CHAPS FOR BIOCHEMISTRY-1GM	1GM	1,482.00
PB-6913	CHAPS FOR BIOCHEMISTRY-5GM	5GM	6,006.00
PB-6914	CHAPSO FOR BIOCHEMISTRY-1GM	1GM	5,413.20
PB-6915	CHAPSO FOR BIOCHEMISTRY-5GM	5GM	19,897.80
PB-6916	CHARCOAL ACTIVATED (ACID WASHED) PHARMA GRADE-500GM	500GM	483.60
PB-6917	CHARCOAL ACTIVATED (ACID WASHED) PHARMA GRADE-5KG	5KG	3,744.00
PB-6918	CHARCOAL ACTIVATED AR (ACID WASHED)-100GM	100GM	592.80
PB-6919	CHARCOAL ACTIVATED AR (ACID WASHED)-500GM	500GM	1,560.00
PB-6920	CHARCOAL ACTIVATED GRANULAR 2.5 TO 4.5 MM	500GM	413.40
PB-6921	CHARCOAL ACTIVATED GRANULAR 2.5 TO 4.5 MM	5KG	3,463.20
PB-6922	CHARCOAL ACTIVATED LR -500GM	500GM	405.60
PB-6923	CHARCOAL ACTIVATED LR -5KG	5KG	3,400.80
PB-6924	CHLORAMINE T (TRIHYDRATE) FOR SYNTHESIS-1KG	1KG	3,525.60
PB-6925	CHLORAMINE T (TRIHYDRATE) FOR SYNTHESIS-500GM	500GM	2,012.40
PB-6926	CHLORAMINE T AR 99% -1KG	1KG	8,041.80
PB-6927	CHLORAMINE T AR 99% -250GM	250GM	2,425.80
PB-6928	CHLORINE TEST PAPER(10 BOOKS)	1BOX	280.80
PB-6929	CHLOROACETYL CHLORIDE FOR SYNTHESIS -2.5LTR	2.5LTR	7,971.60
PB-6930	CHLOROACETYL CHLORIDE FOR SYNTHESIS -500ML	500ML	1,692.60

CODE	PRODUCT	PACKING	PRICE
PB-6931	CHLOROAUIC ACID-1GM	1GM	10,467.60
PB-6932	CHLOROBENZENE LR (MONOCHLOROBENZENE)	500ML	499.20
PB-6933	CHLOROBENZENE LR (MONOCHLOROBENZENE)	2.5LTR	1,872.00
PB-6934	CHLOROFORM -2.5LTR	2.5LTR	1544.40
PB-6935	CHLOROFORM -500ML	500ML	397.80
PB-6936	CHLOROFORM AR-2.5LTR	2.5LTR	1755.00
PB-6937	CHLOROFORM AR-500ML	500ML	499.20
PB-6938	CHLOROFORM FOR HPLC	1LTR	1,318.20
PB-6939	CHLOROFORM FOR HPLC	2.5LTR	2,074.80
PB-6940	CHLOROFORM SPECIALLY DRIED AR	500ML	663.00
PB-6941	CHLOROPHENOL RED INDICATOR AR-25GM	25GM	2,355.60
PB-6942	CHLOROPHENOL RED INDICATOR AR-5GM	5GM	577.20
PB-6943	CHLOROPHENOL RED INDICATOR SOLUTION-125ML	125ML	140.40
PB-6944	CHLOROTEX REAGENT(For determination of chlorine)	100ML	210.60
PB-6945	CHOLESTROL AR-100GM	100GM	14040.00
PB-6946	CHOLESTROL AR-25GM	25GM	3744.00
PB-6947	CHOLESTROL AR-5GM	5GM	780.00
PB-6948	CHOLESTROL LR-100GM	100GM	11,505.00
PB-6949	CHOLESTROL LR-25GM	25GM	2,909.40
PB-6950	CHOLESTROL LR-500GM	500GM	52,143.00
PB-6951	CHOLIC ACID 98% For Biochemistry	25GM	2,769.00
PB-6952	CHOLIC ACID 98% For Biochemistry	100GM	9,562.80
PB-6953	CHOLINE CHLORIDE 98% LR	100GM	319.80
PB-6954	CHOLINE CHLORIDE 98% LR	500GM	1,068.60
PB-6955	CHROMAZUROL S METAL (PM) INDICATOR-10GM	10GM	2,496.00
PB-6956	CHROMAZUROL S METAL (PM) INDICATOR-25GM	25GM	3,806.40
PB-6957	CHROMIUM (III) NITRATE NONAHYDRATE 97%	500-GM	1,497.60
PB-6958	CHROMIUM (III) OXIDE (GREEN) -500GM	500GM	1,591.20
PB-6959	CHROMIUM (III) POTASSIUM SULPHATE DODECAHYDRATE	500GM	1,248.00
PB-6960	CHROMIUM (III) SULPHATE BASIC (HEXAHYDRATE)	500GM	522.60
PB-6961	CHROMIUM (METAL) POWDER-500GM	500GM	4,836.00
PB-6962	CHROMIUM CHLORIDE(HEXAHYDRATE) -500GM	500GM	1,528.80
PB-6963	CHROMIUM TRIOXIDE(CHROMIC ACID) AR	500GM	1,669.20
PB-6964	CHROMIUM TRIOXIDE(CHROMIC ACID)-1KG	1KG	2,215.20
PB-6965	CHROMIUM TRIOXIDE(CHROMIC ACID)-500GM	500GM	1,177.80
PB-6966	CHROMOTROPE 2R C. I. NO. 16570	10GM	733.20
PB-6967	CHROMOTROPE 2R C. I. NO. 16570	25GM	2184.00
PB-6968	CHROMOTROPIC ACID DISODIUM SALT 98%-25GM	25GM	1,177.80
PB-6969	CHROMOTROPIC ACID DISODIUM SALT AR-10GM	10GM	1404.00
PB-6970	CHROMOTROPIC ACID DISODIUM SALT AR-25GM	25GM	3042.00
PB-6971	CHRYSOIDINE R C.I. No. 11320-25GM	25GM	187.20
PB-6972	CHRYSOIDINE R C.I. No. 11321-100GM	100GM	592.80
PB-6973	CHRYSOIDINE Y C.I. No. 11270 -25GM	25GM	187.20
PB-6974	CHRYSOIDINE Y C.I. No. 11271-100GM	100GM	592.80
PB-6975	CINNAMALDEHYDE FOR SYNTHESIS 98%	500ML	1,388.40
PB-6976	CINNAMALDEHYDE FOR SYNTHESIS 98%	2.5LTR	6,520.80
PB-6977	CINNAMIC ACID AR -250GM	250GM	1,560.00
PB-6978	CINNAMIC ACID FOR SYNTHESIS-250GM	250GM	1,068.60
PB-6979	CINNAMIC ACID FOR SYNTHESIS-500GM	500GM	1,942.20
PB-6980	CITRIC ACID ANHYDROUS AR-500GM	500GM	678.60
PB-6981	CITRIC ACID ANHYDROUS AR-5KG	5KG	5,413.20
PB-6982	CITRIC ACID ANHYDROUS LR-500GM	500GM	390.00
PB-6983	CITRIC ACID ANHYDROUS LR-5KG	5KG	3,190.20
PB-6984	CITRIC ACID AR (MONOHYDRATE) -500GM	500GM	592.80
PB-6985	CITRIC ACID AR (MONOHYDRATE) -5KG	5KG	4,711.20
PB-6986	CITRIC ACID PURE (MONOHYDRATE) -500GM	500GM	358.80

CODE	PRODUCT	PACKING	PRICE
PB-6987	CITRIC ACID PURE (MONOHYDRATE) -5KG	5KG	2,917.20
PB-6988	CLOVE OIL-100ML	100ML	904.80
PB-6989	CLOVE OIL-500ML	500ML	3,744.00
PB-6990	COBALT (II) CHLORIDE AR (HEXAHYDRATE)-100GM	100GM	1,076.40
PB-6991	COBALT (II) CHLORIDE AR (HEXAHYDRATE)-500GM	500GM	4,648.80
PB-6992	COBALT (II) CHLORIDE LR (HEXAHYDRATE) -500GM	500GM	3,744.00
PB-6993	COBALT (II) CHLORIDE LR (HEXAHYDRATE) -100GM	100GM	787.80
PB-6994	COBALT (II) NITRATE AR (HEXAHYDRATE)-100GM	100GM	943.80
PB-6995	COBALT (II) NITRATE AR (HEXAHYDRATE)-250GM	250GM	2,152.80
PB-6996	COBALT (II) NITRATE AR (HEXAHYDRATE)-500GM	500GM	4,165.20
PB-6997	COBALT (II) NITRATE LR (HEXAHYDRATE)-100GM	100GM	663.00
PB-6998	COBALT (II) NITRATE LR (HEXAHYDRATE)-500GM	500GM	3,026.40
PB-6999	COBALT (II) SULPHATE AR (HEPTAHYDRATE)-100GM	100GM	928.20
PB-7000	COBALT (II) SULPHATE AR (HEPTAHYDRATE)-250GM	250GM	2,152.80
PB-7001	COBALT (II) SULPHATE AR (HEPTAHYDRATE)-500GM	500GM	4,165.20
PB-7002	COBALT (II) SULPHATE LR (HEPTAHYDRATE)-100GM	100GM	764.40
PB-7003	COBALT (II) SULPHATE LR (HEPTAHYDRATE)-500GM	500GM	3,603.60
PB-7004	COBALT CARBONATE (BASIC) LR -500GM	500GM	7,441.20
PB-7005	COBALT CARBONATE (BASIC) LR -250GM	250GM	3,814.20
PB-7006	COBALT CARBONATE (BASIC) LR-100GM	100GM	1,622.40
PB-7007	COBALT OXIDE AR (FOR DETERMINATION OF SULPHUR)-100GM	100GM	4,024.80
PB-7008	COBALT OXIDE AR (FOR DETERMINATION OF SULPHUR)-500GM	500GM	16,364.40
PB-7009	COBALT OXIDE PURE-100GM	100GM	2,051.40
PB-7010	COBALT OXIDE PURE-500GM	500GM	9,562.80
PB-7011	COBALT(II) ACETATE (TETRAHYDRATE)-250GM	250GM	2,355.60
PB-7012	COBALT(II) ACETATE (TETRAHYDRATE)-500GM	500GM	4,024.80
PB-7013	COBALT(II) ACETATE AR (TETRAHYDRATE)-100GM	100GM	1,341.60
PB-7014	COBALT(II) ACETATE AR (TETRAHYDRATE)-250GM	250GM	2,745.60
PB-7015	COBALT(METAL) POWDER (LAB) 99.5%-100GM	100GM	3,603.60
PB-7016	COBALT(METAL) POWDER (LAB) 99.5%-500GM	500GM	16,645.20
PB-7017	COLCHICINE -10GM	10GM	16,637.40
PB-7018	COLCHICINE -1GM	1GM	1,942.20
PB-7019	CONGO RED INDICATOR FOR MICROSCOPY-100GM	100GM	499.20
PB-7020	CONGO RED INDICATOR FOR MICROSCOPY-25GM	25GM	163.80
PB-7021	CONGO RED INDICATOR SOLUTION)-125ML	125ML	163.80
PB-7022	COOMASIE BRILLANT BLUE G 250-5GM	5 GM	943.80
PB-7023	COOMASIE BRILLANT BLUE G 251-25GM	25GM	3,533.40
PB-7024	COOMASIE BRILLANT BLUE R 250 FOR GEL ELECTROPHORESIS-25GM	25GM	3,463.20
PB-7025	COOMASIE BRILLANT BLUE R 250 FOR GEL ELECTROPHORESIS-5GM	5GM	982.80
PB-7026	COPPER (METAL) POWDER ELECTROLYTIC(325 MESH)-500GM	500GM	3,588.00
PB-7027	COPPER FINE POWDER (325 MESH) 99.7% AR	250GM	2,691.00
PB-7028	COPPER FINE POWDER (325 MESH) 99.7% AR	500GM	5,148.00
PB-7029	COUMARIN FOR SYNTHESIS-250GM	250GM	1,661.40
PB-7030	COUMARIN FOR SYNTHESIS-500GM	500GM	3,042.00
PB-7031	CREATINE (MONOHYDRATE) -100GM	100GM	1,107.60
PB-7032	CREATINE (MONOHYDRATE) -25GM	25GM	358.80
PB-7033	CREATININE AR-10GM	10GM	452.40
PB-7034	CREATININE AR-1KG	1KG	21,910.20
PB-7035	CREATININE AR-25GM	25GM	873.60
PB-7036	CREATININE-100GM	100GM	2,074.80
PB-7037	CREATININE-1KG	1KG	17,612.40
PB-7038	CREATININE-25GM	25GM	764.40
PB-7039	CRESOL RED INDICATOR AR-25GM	25GM	655.20
PB-7040	CRESOL RED INDICATOR AR-5GM	5GM	187.20
PB-7041	CRESOL RED INDICATOR SOLUTION-125ML	125ML	163.80
PB-7042	CRESYL VIOLET (ACETATE) FOR MICROSCOPY-1GM	1GM	1,014.00

CODE	PRODUCT	PACKING	PRICE
PB-7043	CRESYL VIOLET (ACETATE) FOR MICROSCOPY-5GM	5GM	2,730.00
PB-7044	CRYOLITE (Sodium Hexafluoroaluminate) -500GM	500GM	444.60
PB-7045	CRYSTAL VIOLET FOR MICROSCOPY-100GM	100GM	1,341.60
PB-7046	CRYSTAL VIOLET FOR MICROSCOPY-25GM	25GM	421.20
PB-7047	CRYSTAL VIOLET STAINING SOLUTION GRAMS)-125ML	125ML	171.60
PB-7048	CUPFERRON AR-100GM	100GM	2,917.20
PB-7049	CUPFERRON AR-25GM	25GM	803.40
PB-7050	CUPRIC ACETATE (MONOHYDRATE) AR-250GM	250GM	1,318.20
PB-7051	CUPRIC ACETATE (MONOHYDRATE)-250GM	250GM	858.00
PB-7052	CUPRIC ACETATE (MONOHYDRATE)-500GM	500GM	1,450.80
PB-7053	CUPRIC CARBONATE (BASIC) LR-500GM	500GM	1,591.20
PB-7054	CUPRIC CHLORIDE (DIHYDRATE)-500GM	500GM	1,248.00
PB-7055	CUPRIC CHLORIDE AR (DIHYDRATE)-500GM	500GM	1,731.60
PB-7056	CUPRIC NITRATE AR (TRIHYDRATE)-500GM	500GM	1,154.40
PB-7057	CUPRIC NITRATE LR (TRIHYDRATE)-250GM	250GM	499.20
PB-7058	CUPRIC NITRATE LR (TRIHYDRATE)-500GM	500GM	928.20
PB-7059	CUPRIC OXIDE POWDER AR-100GM	100GM	780.00
PB-7060	CUPRIC OXIDE POWDER AR-500GM	500GM	3,603.60
PB-7061	CUPRIC OXIDE POWDER LR-100GM	100GM	655.20
PB-7062	CUPRIC OXIDE POWDER LR-500GM	500GM	3,049.80
PB-7063	CUPRIC SULPHATE AR (PENTAhydrate)-500GM	500GM	858.00
PB-7064	CUPRIC SULPHATE LR (PENTAhydrate)-1KG	1KG	1,497.60
PB-7065	CUPRIC SULPHATE LR (PENTAhydrate)-500GM	500GM	780.00
PB-7066	CUPRIC SULPHATE LR (PENTAhydrate)-5KG	5KG	6,793.80
PB-7067	CUPROUS CHLORIDE AR-250GM	250GM	3,322.80
PB-7068	CUPROUS CHLORIDE-1KG	1KG	2,355.60
PB-7069	CUPROUS CHLORIDE-500GM	500GM	1,248.00
PB-7070	CUPROUS OXIDE RED LR -500GM	500GM	2,355.60
PB-7071	CURCUMIN CRYSTALLINE 99%	5GM	928.20
PB-7072	CURCUMIN CRYSTALLINE 99%	10GM	1,731.60
PB-7073	CYANOACETAMIDE (Malonamide Nitrile)-100GM	100GM	764.40
PB-7074	CYANOACETAMIDE (Malonamide Nitrile)-500GM	500GM	2,457.00
PB-7075	CYANOACETIC ACID FOR SYNTHESIS-1KG	1KG	4,851.60
PB-7076	CYANOACETIC ACID FOR SYNTHESIS-250GM	250GM	1,388.40
PB-7077	CYANOCOBALAMINE FOR BIOCHEMISTRY-1GM	1GM	1,942.20
PB-7078	CYANOCOBALAMINE FOR BIOCHEMISTRY-250MG	250MG	655.20
PB-7079	CYANOGEN BROMIDE FOR SYNTHESIS-100GM	100GM	2,035.80
PB-7080	CYANOGEN BROMIDE FOR SYNTHESIS-500GM	500GM	9,500.40
PB-7081	CYCLOHEXANE AR-2.5LTR	2.5LTR	2,496.00
PB-7082	CYCLOHEXANE AR-500ML	500ML	592.80
PB-7083	CYCLOHEXANE LR-2.5LTR	2.5LTR	2,082.60
PB-7084	CYCLOHEXANE LR-500ML	500ML	522.60
PB-7085	CYCLOHEXANOL AR 99.5%	500ML	928.20
PB-7086	CYCLOHEXANOL AR 99.5%	2.5LTR	3,884.40
PB-7087	CYCLOHEXANOL LR 99%	500ML	803.40
PB-7088	CYCLOHEXANOL LR 99%	2.5LTR	3,744.00
PB-7089	CYCLOHEXANONE 99% AR-2.5LTR	2.5LTR	3,120.00
PB-7090	CYCLOHEXANONE 99% AR-500ML	500ML	709.80
PB-7091	CYCLOHEXANONE LR 99%-2.5LTR	2.5LTR	2,839.20
PB-7092	CYCLOHEXANONE LR 99%-500ML	500ML	663.00
PB-7093	CYCLOHEXYLAMINE FOR SYNTHESIS 99%	500ML	561.60
PB-7094	CYCLOHEXYLAMINE FOR SYNTHESIS 99%	2.5LTR	2,634.84
PB-7095	CYSTEAMINE HYDROCHLORIDE for synthesis -100GM	100GM	2,634.84
PB-7096	CYSTEAMINE HYDROCHLORIDE for synthesis -250GM	250GM	11,645.40
PB-7097	CYTOSINE FOR BIOCHEMISTRY-1GM	1GM	195.00
PB-7098	CYTOSINE FOR BIOCHEMISTRY-25GM	25GM	3,853.20

CODE	PRODUCT	PACKING	PRICE
PB-7099	CYTOSINE FOR BIOCHEMISTRY-5GM	5GM	873.60
PB-7100	D(-) TARTARIC ACID -500GM	500GM	4056.00
PB-7101	D(-) TARTARIC ACID-100GM	100GM	982.80
PB-7102	D(-) MANNITOL AR FOR BACTERIOLOGY-250GM	250GM	787.80
PB-7103	D(-) MANNITOL AR FOR BACTERIOLOGY-500GM	500GM	1,201.20
PB-7104	D(-) MANNITOL LR-1KG	1KG	2059.20
PB-7105	D(-) MANNITOL LR-250GM	250GM	624.00
PB-7106	D(-) MANNITOL LR-500GM	500GM	1123.20
PB-7107	D(-)-ARABINOSE AR -10GM	10GM	1,731.60
PB-7108	D(-)-ARABINOSE AR -5GM	5 GM	936.00
PB-7109	D(-)-ARABINOSE AR-25GM	25GM	3,884.40
PB-7110	D(+MELIBIOSE PURISS 99%-25GM	25GM	9,562.80
PB-7111	D(+MELIBIOSE PURISS 99%-5GM	5 GM	2,425.80
PB-7112	D(+RIBOSE FOR BIOCHEMISTRY-25GM	25GM	1388.40
PB-7113	D(+RIBOSE FOR BIOCHEMISTRY-5GM	5GM	405.60
PB-7114	D.P.X MOUNTANT FOR MICROSCOPY-250ML	250ML	733.20
PB-7115	D.P.X MOUNTANT FOR MICROSCOPY-500ML	500ML	1404.00
PB-7116	D-10 CAMPHOR SULPHONIC ACID-100GM	100GM	2,215.20
PB-7117	D-10 CAMPHOR SULPHONIC ACID-500GM	500GM	8,736.00
PB-7118	DARCO G 60-500GM	500GM	1,318.20
PB-7119	D-BIOTIN FOR BIOCHEMISTRY (VITAMIN H)-100MG	100MG	124.80
PB-7120	D-BIOTIN FOR BIOCHEMISTRY (VITAMIN H)-10GM	10GM	9,430.20
PB-7121	D-BIOTIN FOR BIOCHEMISTRY (VITAMIN H)-1GM	1GM	1,021.80
PB-7122	DEAE CELLULOSE -25GM	25GM	13,306.80
PB-7123	DEAE CELLULOSE-100GM	100GM	47,088.60
PB-7124	DEAE CELLULOSE-5GM	5GM	2,948.40
PB-7125	DEOXYRIBONUCLEIC ACID SODIUM SALT-10GM	10GM	2,636.40
PB-7126	DEOXYRIBONUCLEIC ACID SODIUM SALT-25GM	25GM	5,506.80
PB-7127	DEVARDA'S ALLOY POWDER AR-100GM	100GM	1,716.00
PB-7128	DEVARDA'S ALLOY POWDER AR-250GM	250GM	3,744.00
PB-7129	DEVARDAS ALLOY-100GM	100GM	1,201.20
PB-7130	DEVARDAS ALLOY-500GM	500GM	4,290.00
PB-7131	DEXTRINE WHITE-500GM	500GM	296.40
PB-7132	DEXTROSE ANHYDROUS AR-500GM	500GM	343.20
PB-7133	DEXTROSE (MONOHYDRATE) AR	500GM	304.20
PB-7134	DEXTROSE (MONOHYDRATE)-500GM	500GM	241.80
PB-7135	DEXTROSE ANHYDROUS PURIFIED-1KG	1KG	585.00
PB-7136	DEXTROSE ANHYDROUS PURIFIED-500GM	500GM	319.80
PB-7137	DEXTROSE ANHYDROUS PURIFIED-5KG	5KG	2,293.20
PB-7138	D-FRUCTOSE AR-100GM	100GM	280.80
PB-7139	D-FRUCTOSE GR-250GM	250GM	530.40
PB-7140	D-FRUCTOSE LR-100GM	100GM	187.20
PB-7141	D-FRUCTOSE LR-250GM	250GM	429.00
PB-7142	D-FRUCTOSE LR-500GM	500GM	764.40
PB-7143	D-GALACTOSE LR-100GM	100GM	4134.00
PB-7144	D-GALACTOSE LR-25GM	25GM	1092.00
PB-7145	DIACETYL FLUORESCEIN	5GM	4,368.00
PB-7146	DIACETYL MONOXIME AR-100GM	100GM	1,731.60
PB-7147	DIACETYL MONOXIME AR-100GM	250GM	4,165.20
PB-7148	DIACETYL MONOXIME AR-25GM	25GM	530.40
PB-7149	di-AMMONIUM HYDROGEN O'PHOS PURIFIED -500GM	500GM	538.20
PB-7150	di-AMMONIUM HYDROGEN O'PHOSPHATE AR-500GM	500GM	624.00
PB-7151	di-AMMONIUM HYDROGEN O'PHOSPHATE PURIFIED-5KG	5KG	4,921.80
PB-7152	DIASTASE(FUNGAL)-100GM	100GM	733.20
PB-7153	DIASTASE(FUNGAL)-500GM	500GM	3,120.00
PB-7154	DIAZO REAGENT A For bilirubin determination-250ML	250ML	460.20

CODE	PRODUCT	PACKING	PRICE
PB-7155	DIAZO REAGENT B For bilirubin determination-250ML	250ML	460.20
PB-7156	DIBENZOYL-D-TARTARIC ACID ANHYDROUS FOR SYNTHESIS-100GM	100GM	2,215.20
PB-7157	DIBENZOYL-D-TARTARIC ACID ANHYDROUS FOR SYNTHESIS-25GM	25GM	639.60
PB-7158	di-BORON TRIOXIDE -250GM	250GM	4,438.20
PB-7159	di-BORON TRIOXIDE -500GM	500GM	8,182.20
PB-7160	DIBUTYL ETHER FOR SYNTHESIS	500ML	858.00
PB-7161	DIBUTYL ETHER FOR SYNTHESIS	2.5LTR	4,024.80
PB-7162	DIBUTYL MALEATE LR-2.5LTR	2.5LTR	3,190.20
PB-7163	DIBUTYL MALEATE LR-500ML	500ML	780.00
PB-7164	DIBUTYL PHTHALATE FOR SYNTHESIS 99% (DBP)-2.5LTR	2.5LTR	2,566.20
PB-7165	DIBUTYL PHTHALATE FOR SYNTHESIS 99% (DBP)-500ML	500ML	538.20
PB-7166	DICHLOROMETHANE AR (Methylene Chloride)-2.5LTR	2.5LTR	1,661.40
PB-7167	DICHLOROMETHANE AR (Methylene Chloride)-500ML	500ML	436.80
PB-7168	DICHLOROMETHANE LR (Methylene Chloride)-2.5LTR	2.5LTR	1,528.80
PB-7169	DICHLOROMETHANE LR (Methylene Chloride)-500ML	500ML	405.60
PB-7170	DICHLOROMETHANE SPECIALLY DRIED AR	250GM	444.60
PB-7171	DICYANDIAMIDE PURE-500GM	500GM	826.80
PB-7172	DIETHANOLAMINE AR-2.5LTR	2.5LTR	2,698.80
PB-7173	DIETHANOLAMINE AR-500ML	500ML	647.40
PB-7174	DIETHANOLAMINE LR-2.5LTR	2.5LTR	2,496.00
PB-7175	DIETHANOLAMINE LR-500ML	500ML	553.80
PB-64699	DIETHYLENTRIAMINEPENTAACETIC ACID (DTPA) extrapure AR, 99%	500gm	3,478.80
PB-7176	DIETHYL AMINE HYDROCHLORIDE FOR SYNTHESIS	500GM	904.80
PB-7177	DIETHYL CARBONATE FOR SYNTHESIS 99%	500ML	1,037.40
PB-7178	DIETHYL CARBONATE FOR SYNTHESIS 99%	2.5LTR	4,438.20
PB-7179	DIETHYL ETHER (STABILISED) LR-2.5LTR	2.5LTR	2059.20
PB-7180	DIETHYL ETHER (STABILISED) LR-500ML	500ML	499.20
PB-7181	DIETHYL ETHER AR (STABILISED)-2.5LTR	2.5LTR	2,215.20
PB-7182	DIETHYL ETHER AR (STABILISED)-500ML	500ML	577.20
PB-7183	DIETHYL MALONATE FOR SYNTHESIS 98%	500ML	834.60
PB-7184	DIETHYL MALONATE FOR SYNTHESIS 98%	2.5LTR	3,884.40
PB-7185	DIETHYL PHTHALATE LR 99%	500ML	577.20
PB-7186	DIETHYL PHTHALATE LR 99%	2.5LTR	2,636.40
PB-7187	DIETHYLAMINE LR 99.5 % -2.5LTR	2.5LTR	2,074.80
PB-7188	DIETHYLAMINE LR 99.5 % -500ML	500ML	499.20
PB-7189	DIETHYLENE GLYCOL AR (Digol)	500ML	624.00
PB-7190	DIETHYLENE GLYCOL AR (Digol)	2.5LTR	2,636.40
PB-7191	DIETHYLENE GLYCOL LR (Digol)	500ML	553.80
PB-7192	DIETHYLENE GLYCOL LR (Digol)	2.5LTR	2,285.40
PB-7193	DIETHYLENE GLYCOL MONOBUTYL ETHER LR 98%	500ML	764.40
PB-7194	DIETHYLENE GLYCOL MONOBUTYL ETHER LR 98%	2.5LTR	3,049.80
PB-7195	DIETHYLENE GLYCOL MONOETHYL ETHER LR 98%	500ML	717.60
PB-7196	DIETHYLENE GLYCOL MONOETHYL ETHER LR 98%	2.5LTR	2,917.20
PB-7197	DIETHYLENE GLYCOL MONOMETHYL ETHER LR 98%	500ML	834.60
PB-7198	DIETHYLENE GLYCOL MONOMETHYL ETHER LR 98%	2.5LTR	3,330.60
PB-7199	DIETHYLENE TRIAMINE PENTA ACETIC ACID	100GM	452.40
PB-7200	DIETHYLENE TRIAMINE PENTA ACETIC ACID	500GM	2,012.40
PB-7201	DIETHYLENE TRIAMINE PENTA ACETIC ACID AR 99%	100GM	717.60
PB-7202	DIETHYLENE TRIAMINE PENTA ACETIC ACID AR 99%	500GM	3,322.80
PB-7203	DIGITONIN AR-1GM	1GM	32,588.40
PB-7204	DIIODOMETHANE FOR SYNTHESIS 98%	100GM	5,132.40
PB-7205	DIISOPROPYLAMINE FOR SYNTHESIS 99%	500ML	998.40
PB-7206	DIISOPROPYLAMINE FOR SYNTHESIS 99%	2.5LTR	4,297.80
PB-7207	Di-iso-PROPYLETHER AR 98.5%	500ML	733.20
PB-7208	Di-iso-PROPYLETHER AR 98.5%	2.5LTR	2,698.80
PB-7209	Di-iso-PROPYLETHER LR 98% 2.5LTR	2.5LTR	2,566.20

CODE	PRODUCT	PACKING	PRICE
PB-7210	Di-iso-PROPYLETHER LR 98%-500ML	500ML	663.00
PB-7211	di-LITHIUM TETRABORATE AR-100GM	100GM	2730.00
PB-7212	di-LITHIUM TETRABORATE AR-1KG	1KG	16380.00
PB-7213	DIMEDONE GR-100GM	100GM	5148.00
PB-7214	DIMEDONE GR-25GM	25GM	1911.00
PB-7215	DIMETHYL AMMONIUM CHLORIDE FOR SYNTHESIS-500GM	500GM	702.00
PB-7216	DIMETHYL DIGOL FOR SYNTHESIS 99%	500ML	1,177.80
PB-7217	DIMETHYL DIGOL FOR SYNTHESIS 99%	2.5LTR	4,992.00
PB-7218	DIMETHYL FORMAMIDE SPECIALLY DRIED AR	500ML	468.00
PB-7219	DIMETHYL GLYOXIME AR -100GM	100GM	873.60
PB-7220	DIMETHYL GLYOXIME AR -500GM	500GM	3,260.40
PB-7221	DIMETHYL GLYOXIME LR -100GM	100GM	694.20
PB-7222	DIMETHYL GLYOXIME LR -500GM	500GM	2,979.60
PB-7223	DIMETHYL SULPHATE FOR SYNTHESIS (DFC OF 8 X 500ML)	500ML	577.20
PB-7224	DIMETHYL SULPHOXIDE AR-2.5LTR	2.5LTR	2,566.20
PB-7225	DIMETHYL SULPHOXIDE AR-500ML	500ML	694.20
PB-7226	DIMETHYL SULPHOXIDE HPLC	1LTR	1,450.80
PB-7227	DIMETHYL SULPHOXIDE LR-2.5LTR	2.5LTR	2,355.60
PB-7228	DIMETHYL SULPHOXIDE LR-500ML	500ML	624.00
PB-7229	DIMETHYL SULPHOXIDE SPECIALLY DRIED AR	500ML	826.80
PB-7230	DIMETHYL YELLOW PH INDICATOR C.I.NO. 11020	25GM	163.80
PB-7231	DIMETHYL YELLOW PH INDICATOR C.I.NO. 11020	100GM	522.60
PB-7232	DIMETHYLAMINE SOLUTION 40% FOR SYNTHESIS	500ML	312.00
PB-7233	DIMETHYLAMINE SOLUTION 40% FOR SYNTHESIS	2.5LTR	1,193.40
PB-7234	DIMETHYLFORMAMIDE AR (Formdimethylamide)-2.5LTR	2.5LTR	1,872.00
PB-7235	DIMETHYLFORMAMIDE AR (Formdimethylamide)-500ML	500ML	444.60
PB-7236	DIMETHYLFORMAMIDE FOR HPLC	1LTR	967.20
PB-7237	DIMETHYLFORMAMIDE LR (Formdimethylamide)-2.5LTR	2.5LTR	1,552.20
PB-7238	DIMETHYLFORMAMIDE LR (Formdimethylamide)-500ML	500ML	390.00
PB-7239	DIMIDIUM BROMIDE-100MG	100MG	1326.00
PB-7240	DIMIDIUM BROMIDE-1GM	1GM	9,703.20
PB-7241	DI-N-BUTYLAMINE FOR SYNTHESIS-2.5LTR	2.5LTR	3,744.00
PB-7242	DI-N-BUTYLAMINE FOR SYNTHESIS-500ML	500ML	889.20
PB-7243	DIOCTYL PHTHALATE LR (Bis (2-Ethylhexyl) Phthalate)	500ML	561.60
PB-7244	DIOCTYL PHTHALATE LR (Bis (2-Ethylhexyl) Phthalate)	2.5LTR	2,636.40
PB-7245	DIOCTYL SODIUM SULPHOSUCCINATE (DOSS)-100GM	100GM	452.40
PB-7246	DIOCTYL SODIUM SULPHOSUCCINATE (DOSS)-500GM	500GM	1,840.80
PB-7247	DIOCTYL SODIUM SULPHOSUCCINATE (DOSS)-5KG	5KG	16,918.20
PB-7248	DIPHENYL CARBAZIDE AR-10GM	10GM	1092.00
PB-7249	DIPHENYL CARBAZIDE AR-25GM	25GM	2301.00
PB-7250	DIPHENYL CARBAZIDE-100GM	100GM	6786.00
PB-7251	DIPHENYL CARBAZIDE-25GM	25GM	1872.00
PB-7252	DIPHENYL CARBAZONE AR-25GM	25GM	2,839.20
PB-7253	DIPHENYL CARBAZONE AR-5GM	5GM	624.00
PB-7254	DIPHENYL CARBINOL FOR SYNTHESIS	100GM	577.20
PB-7255	DIPHENYL CARBINOL FOR SYNTHESIS	500GM	2,246.40
PB-7256	DIPHENYL CARBONATE FOR SYNTHESIS 99%	250GM	1,388.40
PB-7257	DIPHENYL CARBONATE FOR SYNTHESIS 99%	1KG	5,132.40
PB-7258	DIPHENYLAMINE AR-100GM	100GM	413.40
PB-7259	DIPHENYLAMINE AR-500GM	500GM	1,622.40
PB-7260	DIPHENYLAMINE-250GM	250GM	762.84
PB-7261	DIPHENYLAMINE-500GM	500GM	1,146.60
PB-7262	DI-P-TOLUOYL-D-TARTARIC ACID MONOHYDRATE	5GM	390.00
PB-7263	DI-P-TOLUOYL-D-TARTARIC ACID MONOHYDRATE	25GM	1,271.40
PB-7264	DI-P-TOLUOYL-D-TARTARIC ACID MONOHYDRATE	100GM	3,884.40
PB-7265	di-SODIUM TETRABORATE (BORAX) AR-500GM	500GM	514.80

CODE	PRODUCT	PACKING	PRICE
PB-7266	di-SODIUM TETRABORATE (BORAX) AR-5KG	5KG	4,212.00
PB-7267	di-SODIUM TETRABORATE (BORAX) LR-500GM	500GM	312.00
PB-7268	di-SODIUM TETRABORATE (BORAX) LR-5KG	5KG	2,652.00
PB-7269	DI-tert-BUTYLDICARBONATE -500ML	500ML	7,901.40
PB-7270	DI-tert-BUTYLDICARBONATE-100ML	100ML	1,661.40
PB-7271	DITHIOOXAMIDE AR (RUBEANIC ACID)-10GM	10GM	9,562.80
PB-7272	DITHIOOXAMIDE AR (RUBEANIC ACID)-5GM	5GM	4,992.00
PB-7273	DITHIZONE AR -25GM	25GM	4,672.20
PB-7274	DITHIZONE AR-5GM	5GM	1,248.00
PB-7275	DITHIZONE-25GM	25GM	4,024.80
PB-7276	DITHIZONE-5GM	5GM	842.40
PB-7277	DL- PHENYLALANINE FOR BIOCHEMISTRY-25GM	25GM	1138.80
PB-7278	DL-ALANINE FOR BIOCHEMISTRY-100GM	100GM	1,138.80
PB-7279	DL-ALANINE FOR BIOCHEMISTRY-25GM	25GM	390.00
PB-7280	DL-ASPARTIC ACID PURE 99%- 100GM	100GM	733.20
PB-7281	DL-ASPARTIC ACID PURE 99%- 25GM	25GM	226.20
PB-7282	DL-a-TOCOPHEROL ACETATE FOR BIOCHEMISTRY(vit-A)-50GM	50GM	1248.00
PB-7283	DL-ISOLEUCINE FOR BIOCHEMISTRY-10GM	10GM	2449.20
PB-7284	DL-ISOLEUCINE FOR BIOCHEMISTRY-25GM	25GM	4945.20
PB-7285	DL-MALIC ACID-500GM	500GM	717.60
PB-7286	DL-MANDELIC ACID 99%-500GM	500GM	4,024.80
PB-7287	DL-METHIONINE FOR BIOCHEMISTRY -100GM	100GM	624.00
PB-7288	DL-METHIONINE FOR BIOCHEMISTRY-500GM	500GM	2,184.00
PB-7289	DL-SERINE PURISS-100GM	100GM	4024.80
PB-7290	DL-SERINE PURISS-25GM	25GM	1497.60
PB-7291	DL-TARTARIC ACID (Synthetic)-500GM	500GM	608.40
PB-7292	DL-TRYPTOPHAN -25GM	25GM	3,260.40
PB-7293	DL-TRYPTOPHAN -5GM	5GM	655.20
PB-7294	DL-VALINE FOR BIOCHEMISTRY-100GM	100GM	3,354.00
PB-7295	DL-VALINE FOR BIOCHEMISTRY-25GM	25GM	982.80
PB-7296	D-MANDELIC ACID -100GM	100GM	1,497.60
PB-7297	D-MANDELIC ACID -500GM	500GM	5,686.20
PB-7298	D-MANNOSE 99% FOR BIOCHEMISTRY-100GM	100GM	5460.00
PB-7299	D-MANNOSE 99% FOR BIOCHEMISTRY-10GM	10GM	592.80
PB-7300	D-MANNOSE 99% FOR BIOCHEMISTRY-25GM	25GM	1794.00
PB-7301	DODECYL BENZENE LR	500ML	858.00
PB-7302	DODECYL BENZENE SULPHONIC ACID SODIUM SALT PURIFIED-500GM	500GM	2,215.20
PB-7303	DOPAMINE HCL-25GM	25GM	10608.00
PB-7304	DOPAMINE HCL-5GM	5GM	2262.00
PB-7305	D-PHENYLALANINE FOR BIOCHEMISTRY-100GM	100GM	20451.60
PB-7306	D-PHENYLALANINE FOR BIOCHEMISTRY-1KG	1KG	145594.80
PB-7307	D-PHENYLALANINE FOR BIOCHEMISTRY-25GM	25GM	5475.60
PB-7308	DPPH (2,2-Diphenyl-1-picrylhydrazyl)	1GM	13,104.00
PB-7309	D-PROLINE -25GM	25GM	11232.00
PB-7310	D-PROLINE -5GM	5GM	2496.00
PB-7311	DRABKIN'S SOLUTION (DILUENT)	5LTR	2,012.40
PB-7312	DRABKIN'S SOLUTION (DILUENT)-500ML	500ML	257.40
PB-7313	D-RAFFINOSE(PENTAHYDRATE) (Melitose)-10GM	10GM	1123.20
PB-7314	D-RAFFINOSE(PENTAHYDRATE) (Melitose)-25GM	25GM	2418.00
PB-7315	DRAGENDROFF'S REAGENT-125ML	125ML	2,074.80
PB-7316	D-SORBITOL LR FOR MICROBIOLOGY-1KG	1KG	1,716.00
PB-7317	D-SORBITOL LR FOR MICROBIOLOGY-250GM	250GM	546.00
PB-7318	D-VALINE FOR BIOCHEMISTRY-25GM	25GM	4,024.80
PB-7319	D-VALINE FOR BIOCHEMISTRY-5GM	5GM	1,107.60
PB-7320	D-XYLOSE PURISS CHR (Culture Media Additive)-100GM	100GM	998.40
PB-7321	D-XYLOSE PURISS CHR (Culture Media Additive)-25GM	25GM	312.00

CODE	PRODUCT	PACKING	PRICE
PB-7322	DYSPROSIUM OXIDE AR-25GM	25GM	3,408.60
PB-7323	DYSPROSIUM OXIDE AR-5GM	5GM	780.00
PB-7324	E.D.T.A. ACID (E.D.T.A. ACID)-100GM	100GM	280.80
PB-7325	E.D.T.A. ACID (E.D.T.A. ACID)-500GM	500GM	936.00
PB-7326	E.D.T.A. ACID CALCIUM DI-SODIUM SALT HYDRATE	500GM	1,528.80
PB-7327	E.D.T.A. DIPOTASSIUM SALT -100GM	100GM	319.80
PB-7328	E.D.T.A. DIPOTASSIUM SALT -500GM	500GM	1,248.00
PB-7329	E.D.T.A. DIPOTASSIUM SALT AR-100GM	100GM	405.60
PB-7330	E.D.T.A. DIPOTASSIUM SALT AR-500GM	500GM	1,450.80
PB-7331	E.D.T.A. DISODIUM SALT N/10 SOLN. -500ML	500ML	265.20
PB-7332	E.D.T.A. DISODIUM SALT AR -100GM	100GM	319.80
PB-7333	E.D.T.A. DISODIUM SALT AR -500GM	500GM	1,045.20
PB-7334	E.D.T.A. DISODIUM SALT N/50 SOLN.-500ML	500ML	234.00
PB-7335	E.D.T.A. DISODIUM SALT-100GM	100GM	249.60
PB-7336	E.D.T.A. DISODIUM SALT-500GM	500GM	873.60
PB-7337	E.D.T.A. SOLUTION 10% w/v	125ML	156.00
PB-7338	E.D.T.A. SOLUTION 5% w/v	125ML	124.80
PB-7339	E.D.T.A. TETRASODIUM SALT (DIHYDRATE)-100GM	100GM	421.20
PB-7340	E.D.T.A. TETRASODIUM SALT (DIHYDRATE)-500GM	500GM	1,154.40
PB-7341	E.D.T.A.TRI POTASSIUM SALT (DIHYDRATE)	250GM	733.20
PB-7342	E.D.T.A.TRI POTASSIUM SALT (DIHYDRATE)	1KG	2,262.00
PB-7343	EGG ALBUMINE FLAKES (CRYSTAL)-500GM	500GM	7488.00
PB-7344	EGG ALBUMINE POWDER-500GM	500GM	3,463.20
PB-7345	EHRlich'S 'A' REAGENT-250ML	250 ML	195.00
PB-7346	EHRlich'S 'B' REAGENT-250ML	250 ML	195.00
PB-7347	EHRlich'S REAGENT-125ML	125ML	124.80
PB-7348	EHRlich'S REAGENT-500ML	500ML	538.20
PB-7349	EOSIN STAINING SOLUTION (2% w/v)-125ML	125ML	163.80
PB-7350	EOSIN STAINING SOLUTION (2% w/v)-500ML	500ML	429.00
PB-7351	EOSINE BLUE FOR MICROSCOPY C.I.No. 45400-100GM	100GM	1,903.20
PB-7352	EOSINE BLUE FOR MICROSCOPY C.I.No. 45400-25GM	25GM	663.00
PB-7353	EOSINE SPIRIT SOLUBLE -100GM	100GM	1,622.40
PB-7354	EOSINE SPIRIT SOLUBLE -25GM	25GM	569.40
PB-7355	EOSINE YELLOW FOR MICROSCOPY-100GM	100GM	928.20
PB-7356	EOSINE YELLOW FOR MICROSCOPY-25GM	25GM	296.40
PB-7357	EOSINE YELLOW SOLUTION -125ML	125ML	132.60
PB-7358	ERIOCHROME BLACK T -100GM	100GM	998.40
PB-7359	ERIOCHROME BLACK T -25GM	25GM	327.60
PB-7360	ERIOCHROME BLACK T AR-100GM	100GM	1,154.40
PB-7361	ERIOCHROME BLACK T AR-25GM	25GM	390.00
PB-7362	ERIOCHROME BLUE BLACK B METAL INDICATOR-25GM	25GM	1,177.80
PB-7363	ERIOCHROME BLUE BLACK B METAL INDICATOR-5GM	5GM	413.40
PB-7364	ERIOCHROME CYANINE R AR (Reagent for Aluminium)-10GM	10GM	1,107.60
PB-7365	ERIOCHROME CYANINE R AR (Reagent for Aluminium)-25GM	25GM	2,496.00
PB-7366	ERIOGLAUCINE (REDOX INDIATOR) C.I. NO.42090-10GM	10GM	982.80
PB-7367	ERIOGLAUCINE (REDOX INDIATOR) C.I. NO.42091-25GM	25GM	1,942.20
PB-7368	ERYTHROSINE B FIR MICROSCOPYC.I. NO. 45430-25GM	25GM	858.00
PB-7369	ERYTHROSINE B FIR MICROSCOPYC.I. NO. 45431-100GM	100GM	3,190.20
PB-7370	ESBACH'S REAGENT	125ML	163.80
PB-7371	ESCHKA'S MIXTURE AR-1KG	1KG	60840.00
PB-7372	ESCHKA'S MIXTURE AR-250GM	250GM	18720.00
PB-7373	ETHANOLAMINE(MONO) 99% AR-2.5LTR	2.5LTR	2,776.80
PB-7374	ETHANOLAMINE(MONO) 99% AR-500ML	500ML	655.20
PB-7375	ETHANOLAMINE(MONO)-LR 99%-2.5LTR	2.5LTR	2,293.20
PB-7376	ETHANOLAMINE(MONO) LR 99%-500ML	500ML	530.40
PB-7377	ETHANOL (DIRECTLY SOLD BY THE MANUFACTURER TO THE END USER)	500ML	330.00

CODE	PRODUCT	PACKING	PRICE
PB-7377	ETHIDIUM BROMIDE AR-1GM	1GM	1170.00
PB-7378	ETHIDIUM BROMIDE AR-5GM	5GM	4524.00
PB-7379	ETHYL ACETATE LR-2.5LTR	2.5 LIT	1404.00
PB-7380	ETHYL ACETATE LR-500ML	500ML	358.80
PB-7381	ETHYL ACETATE AR-2.5LTR	2.5 LIT	1,528.80
PB-7382	ETHYL ACETATE AR-500ML	500ML	413.40
PB-7383	ETHYL ACETATE HPLC/UV SPECTROSCOPY	1LTR	936.00
PB-7384	ETHYL ACETATE HPLC/UV SPECTROSCOPY	2.5LTR	2,012.40
PB-7385	ETHYL ACETO ACETATE FOR SYNTHESIS	500ML	998.40
PB-7386	ETHYL ACETO ACETATE FOR SYNTHESIS	2.5LTR	4,165.20
PB-7387	ETHYL BENZOATE 99% FOR SYNTHESIS	500ML	1,450.80
PB-7388	ETHYL BENZOATE 99% FOR SYNTHESIS	2.5LTR	6,793.80
PB-7389	ETHYL CELLULOSE LOW VISCOCITY (7CPS)-500GM	500GM	5,132.40
PB-7390	ETHYL CELLULOSE(18-22CPS)-500GM	500GM	4,851.60
PB-7391	ETHYL CHLOROFORMATE FOR SYNTHESIS	250ML	834.60
PB-7392	ETHYL CHLOROFORMATE FOR SYNTHESIS	500ML	1,528.80
PB-7393	ETHYL CHLOROFORMATE FOR SYNTHESIS	2.5LTR	6,793.80
PB-7394	ETHYL FORMATE FOR SYNTHESIS	500ML	787.80
PB-7395	ETHYL FORMATE FOR SYNTHESIS	2.5LTR	3,673.80
PB-7396	ETHYL IODIDE FOR SYNTHESIS-100ML	100ML	6,099.60
PB-7397	ETHYL IODIDE FOR SYNTHESIS-250ML	250ML	13,728.00
PB-7398	ETHYL OLEATE FOR SYNTHESIS 98%	500ML	928.20
PB-7399	ETHYL OLEATE FOR SYNTHESIS 98%	2.5LTR	4,438.20
PB-7400	ETHYL TRIFLUORO ACETATE	100GM	1,450.80
PB-7401	ETHYL TRIFLUORO ACETATE	500GM	5,413.20
PB-7402	ETHYLENE GLYCOL AR 99% (1,2-ETHANEDIOL) (M.E.G.) -2.5LTR	2.5LTR	2,012.40
PB-7403	ETHYLENE GLYCOL AR 99% (1,2-ETHANEDIOL) (M.E.G.) -500ML	500ML	530.40
PB-7404	ETHYLENE GLYCOL DIMETHYL ETHER LR 99%	500ML	1,287.00
PB-7405	ETHYLENE GLYCOL DIMETHYL ETHER LR 99%	2.5LTR	5,959.20
PB-7406	ETHYLENE GLYCOL LR 98% (1,2-ETHANEDIOL)(M.E.G.)-2.5LTR	2.5LTR	1,872.00
PB-7407	ETHYLENE GLYCOL LR 98% (1,2-ETHANEDIOL)(M.E.G.)-500ML	500ML	460.20
PB-7408	EUCALYPTUS OIL-250ML	250ML	2,012.40
PB-7409	EUGENOL 99% LR	100ML	1,528.80
PB-7410	EUGENOL 99% LR	500ML	7,488.00
PB-7411	EUROPIUM OXIDE AR-1GM	1GM	2652.00
PB-7412	EUROPIUM OXIDE AR-5GM	5GM	8736.00
PB-7413	EVAN'S BLUE 90% C.I. NO. 23861-25GM	25GM	1,138.80
PB-7414	EVAN'S BLUE 90% C.I. NO. 23860-5GM	5 GM	280.80
PB-7415	FAST BLUE B SALT-100GM	100GM	3,322.80
PB-7416	FAST BLUE B SALT-25GM	25GM	951.60
PB-7417	FAST GREEN FCF FOR MICROSCOPY C.I.NO. 42053	5GM	577.20
PB-7418	FAST GREEN FCF FOR MICROSCOPY C.I.NO. 42053	25GM	2,262.00
PB-7419	FEHLING'S SOLUTION NO.1-500ML	500ML	335.40
PB-7420	FEHLING'S SOLUTION NO.2-500ML	500ML	507.00
PB-7421	FERRIC CHLORIDE (ANHYDROUS)-1KG	1KG	592.80
PB-7422	FERRIC CHLORIDE (ANHYDROUS)-500GM	500GM	358.80
PB-7423	FERRIC CHLORIDE AR (ANHYDROUS)-500GM	500GM	514.80
PB-7424	FERRIC CHLORIDE AR (HEXAHYDRATE)-500GM	500GM	577.20
PB-7425	FERRIC CHLORIDE PURE (HEXAHYDRATE)-500GM	500GM	390.00
PB-7426	FERRIC CITRATE (For Bacteriology)-500GM	500GM	1,177.80
PB-7427	FERRIC NITRATE AR (NONAHYDRATE)-500GM	500GM	1,193.40
PB-7428	FERRIC NITRATE LR (NONAHYDRATE)-500GM	500GM	327.60
PB-7429	FERRIC OXIDE RED-500GM	500GM	358.80
PB-7430	FERRIC SULPHATE LR (MONOHYDRATE)-500GM	500GM	592.80
PB-7431	FERROIN SOLUTION AR 0.025 M (Redox Indicator)-100ML	100ML	1,107.60
PB-7432	FEROUS CHLORIDE (TETRAHYDRATE) LR-500GM	500GM	904.80
PB-7433	FEROUS SULPHATE AR (HEPTAHYDRATE)-500GM	500GM	343.20

CODE	PRODUCT	PACKING	PRICE
PB-7434	FERROUS SULPHATE LR (HEPTAHYDRATE)-500GM	500GM	202.80
PB-7435	FERROUS SULPHATE LR (HEPTAHYDRATE)-5KG	5KG	1,669.20
PB-7436	FERROUS SULPHIDE FUSED STICKS-1KG	1KG	655.20
PB-7437	FIELD STAIN A FOR MICROSCOPICAL STAINING-125ML	125ML	156.00
PB-7438	FIELD STAIN A FOR MICROSCOPY-25GM	25GM	280.80
PB-7439	FIELD STAIN B FOR MICROSCOPICAL STAINING-125ML	125ML	156.00
PB-7440	FIELD STAIN B FOR MICROSCOPY-25GM	25GM	280.80
PB-7441	FLORISIL® 60 - 100 MESH FOR COLUMN CHROMATOGRAPHY-100GM	100GM	3,049.80
PB-7442	FLORISIL® 60 - 100 MESH FOR COLUMN CHROMATOGRAPHY-500GM	500GM	13,587.60
PB-7443	FLUORENE FOR SYNTHESIS	100GM	2,355.60
PB-7444	FLUORENE FOR SYNTHESIS	250GM	5,686.20
PB55091	FLUORESCEIN SODIUM SALT	100GM	12,299.30
PB-7445	FLUORESCEIN	25GM	249.60
PB-7446	FLUORESCEIN	100GM	803.40
PB-7447	FLUORESCEIN SODIUM	25GM	327.60
PB-7448	FLUORESCEIN SODIUM	100GM	1,014.00
PBF1303	FLUORESCEIN DIACETATE (FDA)	1GM	13,760.50
PB-7449	FLUOROBENZENE FOR SYNTHESIS-2.5LTR	2.5LTR	8,876.40
PB-7450	FLUOROBENZENE FOR SYNTHESIS-500ML	500ML	1,942.20
PB-7451	FOLIC ACID FOR BIOCHEMISTRY-100GM	100GM	3744.00
PB-7452	FOLIC ACID FOR BIOCHEMISTRY-10GM	10GM	795.60
PB-7453	FOLIC ACID FOR BIOCHEMISTRY-5GM	5GM	468.00
PB-7454	FOLIN & CIOCATEU'S PHENOL REAGENT-100ML	100ML	530.40
PB-7455	FOLIN & CIOCATEU'S PHENOL REAGENT-500ML	500ML	1,942.20
PB-7456	FOLIN & WU'S ALKALINE COPPER SOLUTION-500ML	500ML	273.00
PB-7457	FORMALDEHYDE SOLUTION AR 37-41% W/V-2.5LTR	2.5LTR	1201.20
PB-7458	FORMALDEHYDE SOLUTION AR 37-41% W/V-500ML	500ML	327.60
PB-7459	FORMALDEHYDE SOLUTION LR 37-41% W/V-2.5LTR	2.5LTR	889.20
PB-7460	FORMALDEHYDE SOLUTION LR 37-41% W/V-500ML	500ML	249.60
PB-7461	FORMALDEHYDE SOLUTION LR 37-41% W/V-5LTR	5LTR	1482.00
PB-7462	FORMAMIDE LR 98%-2.5LTR	2.5LTR	2,636.40
PB-7463	FORMAMIDE LR 98%-500ML	500ML	733.20
PB-7464	FORMIC ACID (about 85%)-2.5LTR	2.5LTR	1,482.00
PB-7465	FORMIC ACID (about 85%)-500ML	500ML	358.80
PB-7466	FORMIC ACID AR 98%-2.5LTR	2.5LTR	2,698.80
PB-7467	FORMIC ACID AR 98%500ML	500ML	733.20
PB-7468	FORMIC ACID LR 98%-2.5LTR	2.5LTR	2,558.40
PB-7469	FORMIC ACID LR 98%-500ML	500ML	663.00
PB-7470	FOUCHET'S REAGENT-125ML	125ML	117.00
PB-7471	FUCHSIN ACID FOR MICROSCOPY C.I. No. 42685-25GM	25GM	694.20
PB-7472	FUCHSIN ACID FOR MICROSCOPY C.I. No. 42686-100GM	100GM	2,425.80
PB-7473	FUCHSIN BASIC 0.1 W/V-125ML	125 ML	156.00
PB-7474	FUCHSIN BASIC FOR MICROSCOPY (ROSANILINE HCL)-100GM	100GM	1,068.60
PB-7475	FUCHSIN BASIC FOR MICROSCOPY (ROSANILINE HCL)-25GM	25GM	390.00
PB-7476	FULLER'S EARTH FOR ABSORPTION PURPOSE-500GM	500GM	202.80
PB-7477	FUMARIC ACID FOR SYNTHESIS-500GM	500GM	639.60
PB-7478	FUMARIC ACID FOR SYNTHESIS-5KG	5KG	5,506.80
PB-7479	FURFURAL 98% FOR SYNTHESIS (FURFURALDEHYDE)	500ML	787.80
PB-7480	FURFURAL 98% FOR SYNTHESIS (FURFURALDEHYDE)	2.5LTR	2,917.20
PB-7481	FURFURYL ALCOHOL 98% FOR SYNTHESIS	500ML	1,138.80
PB-7482	FURFURYL ALCOHOL 98% FOR SYNTHESIS	2.5LTR	5,132.40
PB-7483	FURFURYLAMINE LR 98%-2.5LTR	2.5LTR	6,099.60
PB-7484	FURFURYLAMINE LR 98%-500ML	500ML	1,318.20
PB-7485	FUSION MIXTURE LR-500GM	500GM	390.00
PB-7486	FUSION MIXTURE GR-500GM	500GM	452.40
PB-7487	GADOLINIUM OXIDE 99.9% - 5GM	5GM	1872.00

CODE	PRODUCT	PACKING	PRICE
PB-7488	GADOLINIUM OXIDE 99.9% -25GM	25GM	5304.00
PB-7489	GALLIC ACID 99.5%-100GM	100GM	1,528.80
PB-7490	GALLIC ACID 99.5%-500GM	500GM	4,711.20
PB-7491	GELATIN POWDER FOR BATERIOLOGY-500GM	500GM	1638.00
PB-7492	GENTIAN VIOLET (AQUEOUS) Staining Solution-125ML	125ML	296.40
PB-7493	GENTIAN VIOLET GR (Crystal Violet)-100GM	100GM	1,248.00
PB-7494	GENTIAN VIOLET GR (Crystal Violet)-25GM	25GM	405.60
PB-7495	GENTIAN VIOLET(ALCOHOLIC) SOLUTION-125ML	125ML	327.60
PB-7496	GIEMSA'S STAIN FOR MICROSCOPY-100GM	100GM	2,464.80
PB-7497	GIEMSA'S STAIN FOR MICROSCOPY-25GM	25GM	678.60
PB-7498	GIEMSA'S STAINING SOLUTION-100ML	100ML	530.40
PB-7499	GLASS BEADS(3.5-4.5 MM)-500GM	500GM	429.00
PB-7500	GLASS WOOL (LAB) LOW IN LEAD-250GM	250GM	780.00
PB-7501	GLUTARALDEHYDE FOR SYNTHESIS -2.5LTR	2.5LTR	3,603.60
PB-7502	GLUTARALDEHYDE FOR SYNTHESIS -500ML	500ML	787.80
PB-7503	GLUTARIC ACID FOR SYNTHESIS-100GM	100GM	1,084.20
PB-7504	GLUTARIC ACID FOR SYNTHESIS-500GM	500GM	4,851.60
PB-7505	GLUTARIC ANHYDRIDE FOR SYNTHESIS-100GM	100GM	2,152.80
PB-7506	GLUTARIC ANHYDRIDE FOR SYNTHESIS-500GM	500GM	9,430.20
PB-7507	GLUTATHIONE REDUCED-25GM	25GM	8,182.20
PB-7508	GLUTATHIONE REDUCED-5GM	5GM	2,152.80
PB-7509	GLYCEROL GR-2.5LTR	2.5LTR	2028.00
PB-7510	GLYCEROL GR-500ML	500ML	530.40
PB-7511	GLYCEROL LR (GLYCERINE)-2.5LTR	2.5LTR	1934.40
PB-7512	GLYCEROL LR (GLYCERINE)-500ML	500ML	475.80
PB-7513	GLYCEROL TRIACETATE LR (TRIACETIN)	500ML	873.60
PB-7514	GLYCEROL TRIACETATE LR (TRIACETIN)	2.5LTR	3,322.80
PB-7515	GLYCINE AR-100GM	100GM	312.00
PB-7516	GLYCINE AR-500GM	500GM	1357.20
PB-7517	GLYCINE LR-250GM	250GM	514.80
PB-7518	GLYCINE LR-5 KG	5KG	7722.00
PB-7519	GLYCINE LR-500GM	500GM	881.40
PB-7520	GLYCOLIC ACID AQUEOUS SOLUTION-2.5LTR	2.5LTR	8,876.40
PB-7521	GLYCOLIC ACID AQUEOUS SOLUTION-500ML	500ML	2,074.80
PB-7522	GLYCOLIC ACID-100GM	100GM	2,698.80
PB-7523	GLYCOLIC ACID-25GM	25GM	967.20
PB-7524	GLYCOLIC ACID-500GM	500GM	9,843.60
PB-7525	GLYCYL GLYCINE -100GM	100GM	6,240.00
PB-7526	GLYCYL GLYCINE -10GM	10GM	943.80
PB-7527	GLYCYL GLYCINE -25GM	25GM	2,051.40
PB-11530	GLYCYL GLYCINE EXTRAPURE, 99% 100GMS	100GMS	6,992.70
PB-7528	GLYOXAL 40% FOR SYNTHESIS	500ML	499.20
PB-7529	GLYOXAL 40% FOR SYNTHESIS	2.5LTR	2,215.20
PB-7530	GOWER'S REAGENT (RBC DILUTING FLUID)-500ML	500ML	390.00
PB-7531	GRAPHITE FINE POWDER LR	500GM	343.20
PB-7532	GUAIACOL (LIQUID) LR 99% (O-Methoxy Phenol)	500ML	1,942.20
PB-7533	GUANIDINE HYDROCHLORIDE-100GM	100GM	577.20
PB-7534	GUANIDINE HYDROCHLORIDE-500GM	500GM	2121.60
PB-7535	GUANIDINE NITRATE LR 98%	250GM	405.60
PB-7536	GUANIDINE THIOCYANTE FOR BIOCHEMISTRY-100GM	100GM	2,152.80
PB-7537	GUANIDINE THIOCYANTE FOR BIOCHEMISTRY-500GM	500GM	9,843.60
PB-7538	GUAR GUM POWDER OF ENDOSPERM	500GM	1560.00
PB-7539	GUM GHATTI LR	100GM	514.80
PB-7540	GUM GHATTI LR	500GM	2106.00
PB-7541	GUM ROSIN	250GM	717.60
PB-7542	GUM TRAGACANTH-500GM	500GM	1,045.20

CODE	PRODUCT	PACKING	PRICE
PB-7543	HABA FOR AUTOMATIC ANALYSIS-1GM	1GM	429.00
PB-7544	HABA FOR AUTOMATIC ANALYSIS-5GM	5GM	1,357.20
PB-7545	HATU FOR SYNTHESIS -1GM	1GM	1,014.00
PB-7546	HATU FOR SYNTHESIS -25GM	25GM	19188.00
PB-7547	HATU FOR SYNTHESIS -5GM	5GM	4602.00
PB-7548	HAYMEM'S REAGENT-500ML	500ML	452.40
PB-7549	HBTU FOR PEPTIDE SYNTHESIS-100GM	100GM	8,182.20
PB-7550	HBTU FOR PEPTIDE SYNTHESIS-25GM	25GM	2,425.80
PB-7551	HBTU FOR PEPTIDE SYNTHESIS-5GM	5GM	663.00
PB-7552	HEMATOXLIN (HARRIS) staining solution-125ML	125ML	873.60
PB-7553	HEMATOXYLIN (DELAFIELD'S)-125ML	125ML	787.80
PB-7554	HEMATOXYLIN STAIN CERTIFIED FOR MICROSCOPY-25GM	25GM	13416.00
PB-7555	HEMATOXYLIN STAIN CERTIFIED FOR MICROSCOPY-5GM	5-GM	3276.00
PB-7556	HEMATOXYLIN(EHRLICH) STAINING SOLUTION-125ML	125ML	553.80
PB-7557	HEPES (BUFFER) -100GM	100GM	3,400.80
PB-7558	HEPES (BUFFER) -25GM	25GM	1,076.40
PB-7559	HEPES (BUFFER) -500GM	500GM	10,951.20
PB-7560	HEPES (BUFFER) -5GM	5GM	358.80
PB-7561	HEPTANE 85% LR	500ML	436.80
PB-7562	HEPTANE 85% LR	2.5LTR	1,669.20
PB-7563	HEXAMETHYLPHOSPHORIC ACID TRIAMIDE (HMPA)-100 ML	100 ML	1,801.80
PB-7564	HEXAMETHYLPHOSPHORIC ACID TRIAMIDE (HMPA)-500ML	500ML	7,488.00
PB-7565	HEXAMINE AR-500GM	500GM	514.80
PB-7566	HEXAMINE LR (HEXAMETHYLENE TETRAMINE)-500GM	500GM	452.40
PB-7567	HEXAMINE LR (HEXAMETHYLENE TETRAMINE)-5KG	5KG	4,024.80
PB-7568	HEXANE AR-2.5LTR	2.5LTR	1560.00
PB-7569	HEXANE AR-500ML	500ML	436.80
PB-7570	HEXANE LR 65-70 C -2.5LTR	2.5LTR	1450.80
PB-7571	HEXANE LR 65-70C -500ML	500ML	382.20
PB-7572	HIPPURIC ACID CRYSTALS-100GM	100GM	936.00
PB-7573	HIPPURIC ACID CRYSTALS-1KG	1KG	5460.00
PB-7574	HISTAMINE DIHYDROCHLORIDE-25GM	25GM	10296.00
PB-7575	HISTAMINE DIHYDROCHLORIDE-5GM	5GM	2808.00
PB-7576	HOLMIUM OXIDE -25GM	25GM	15,116.40
PB-7577	HOLMIUM OXIDE -5GM	5GM	4,024.80
PB-7578	HUMIC ACID-500GM	500GM	413.40
PB-7579	HUMIC ACID-5KG	5KG	3,463.20
PB-7580	HYAMINE 1622 (Benzethonium chloride)-100GM	100GM	6,661.20
PB-7581	HYAMINE 1622 (Benzethonium chloride)-25GM	25GM	2,293.20
PB-7582	HYAMINE 1622 SOLUTION 0.004M	1LTR	2,293.20
PB-7583	HYAMINE 1622 SOLUTION 0.004M	5LTR	5,132.40
PB-7584	HYDRAZINE HYDRATE 80% AR-2.5LTR	2.5LTR	5,132.40
PB-7585	HYDRAZINE HYDRATE 80% AR-500ML	500ML	1,279.20
PB-7586	HYDRAZINE HYDRATE LR 80% -500ML	500ML	1,209.00
PB-7587	HYDRAZINE HYDRATE LR 80%-2.5LTR	2.5LTR	4,992.00
PB-7588	HYDRAZINE SULPHATE AR-100GM	100GM	460.20
PB-7589	HYDRAZINE SULPHATE AR-500GM	500GM	1,638.00
PB-7590	HYDRAZINE SULPHATE LR-100GM	100GM	390.00
PB-7591	HYDRAZINE SULPHATE LR-500GM	500GM	1,357.20
PB-7592	HYDROCHLORIC ACID AR-2.5LTR	2.5LTR	982.80
PB-7593	HYDROCHLORIC ACID AR-500ML	500ML	343.20
PB-7594	HYDROCHLORIC ACID AR-5LTR	5LTR	1372.80
PB-7595	HYDROCHLORIC ACID LR-2.5LTR	2.5LTR	795.60
PB-7596	HYDROCHLORIC ACID LR-500ML	500ML	296.40
PB-7597	HYDROCHLORIC ACID LR-5LTR	5LTR	1185.60
PB-7598	HYDROCHLORIC ACID N/10 SOLUTION-500ML	500ML	202.80

CODE	PRODUCT	PACKING	PRICE
PB-7599	HYDROFLUORIC ACID 40% AR-500ML	500ML	998.40
PB-7600	HYDROFLUORIC ACID 48% AR-2.5LTR	2.5LIT	3,946.80
PB-7601	HYDROFLUORIC ACID 48% AR-500ML	500ML	1,177.80
PB-7602	HYDROFLUORIC ACID LR 40%-2.5LTR	2.5LTR	2,636.40
PB-7603	HYDROFLUORIC ACID LR 40%-500ML	500ML	624.00
PB-7604	HYDROGEN PEROXIDE 6% SOLUTION(20 VOLUMES)-1LTR	1 LIT	304.20
PB-7605	HYDROGEN PEROXIDE 30% SOLUTION -500ML	500ML	405.60
PB-7606	HYDROGEN PEROXIDE 30% SOLUTION -500ML	5LTR	2168.40
PB-7607	HYDROGEN PEROXIDE 30% SOLUTION AR	500ML	483.60
PB-7608	HYDROGEN PEROXIDE 30% SOLUTION AR	5LTR	2652.00
PB-7609	HYDROQUINONE AR-100GM	100GM	624.00
PB-7610	HYDROQUINONE AR-500GM	500GM	2,917.20
PB-7611	HYDROQUINONE FOR SYNTHESIS-100GM	100GM	569.40
PB-7612	HYDROQUINONE FOR SYNTHESIS-500GM	500GM	2,698.80
PB-7613	HYDROXY NAPTHOL BLUE (indicator for calcium determination)-25GM	25GM	1950.00
PB-7614	HYDROXY NAPTHOL BLUE (indicator for calcium determination)-5GM	5GM	436.80
PB-7615	HYDROXY PROPYL METHYL CELLULOSE -1KG	1KG	5460.00
PB-7616	HYDROXY PROPYL METHYL CELLULOSE-1KG	1KG	5460.00
PB-7617	HYDROXY PROPYL METHYL CELLULOSE-1KG	1KG	5460.00
PB-7618	HYDROXYETHYL CELLULOSE HIGH VISCOSITY (270mPas)	500GM	2,636.40
PB-7619	HYDROXYETHYL CELLULOSE LOW VISCOSITY (145mPas)	500GM	3,120.00
PB-7620	HYDROXYLAMINE HYDROCHLORIDE AR -100GM	100GM	592.80
PB-7621	HYDROXYLAMINE HYDROCHLORIDE AR -500GM	500GM	2418.00
PB-7622	HYDROXYLAMINE HYDROCHLORIDE FOR SYNTHESIS-100GM	100GM	436.80
PB-7623	HYDROXYLAMINE HYDROCHLORIDE FOR SYNTHESIS-500GM	500GM	2262.00
PB-7624	HYDROXYLAMINE SULPHATE AR-100GM	100GM	265.20
PB-7625	HYDROXYLAMINE SULPHATE AR-500GM	500GM	936.00
PB-7626	HYDROXYLAMINE SULPHATE LR-100GM	100GM	218.40
PB-7627	HYDROXYLAMINE SULPHATE LR-500GM	500GM	873.60
PB-7628	HYFLO SUPER CEL ® (FILTERAID CALCINED)-500GM	500GM	343.20
PB-7629	HYPOXANTHINE FOR BIOCHEMISTRY 99%	5GM	405.60
PB-7630	HYPOXANTHINE FOR BIOCHEMISTRY 99%	25GM	1482.00
PB-7631	HYPOXANTHINE FOR BIOCHEMISTRY 99%	100GM	5304.00
PB-7632	I.N.T. AR 95 % -1GM	1GM	1,450.80
PB-7633	I.N.T. AR 95 % -5GM	5GM	6,793.80
PB-7634	IMIDAZOLE (Glyoxaline)-100GM	100GM	468.00
PB-7635	IMIDAZOLE (Glyoxaline)-500GM	500GM	2,028.00
PB-7636	IMIDAZOLE AR-100GM	100GM	694.20
PB-7637	IMIDAZOLE AR-500GM	500GM	2,496.00
PB-7638	IMINODIACETIC ACID FOR SYNTHESIS -100GM	100GM	577.20
PB-7639	IMINODIACETIC ACID FOR SYNTHESIS -250GM	250GM	1404.00
PB-7640	IMINODIACETIC ACID FOR SYNTHESIS -500GM	500GM	2496.00
PB-7641	IMMERSION OIL FOR MICROSCOPY -125ML	125ML	1,528.80
PB-7642	IMMERSION OIL FOR MICROSCOPY -30ML	30ML	413.40
PB-7643	INDIAN INK-100ML	100ML	312.00
PB-7644	INDICATOR PAPER (With colour scale) (pH1-10)-100LVS	10BKT	499.20
PB-7645	INDICATOR PAPER (With colour scale) (pH2.0-4.5)	10BKT	304.20
PB-7646	INDICATOR PAPER (With colour scale) (pH3.5-6.0)	10BKT	304.20
PB-7647	INDICATOR PAPER (With colour scale) (pH5.5-8.0) -100LVS	10BKT	499.20
PB-7648	INDICATOR PAPER (With colour scale) (pH6.5-9.0)	10BKT	304.20
PB-7649	INDICATOR PAPER FULL RANGE (With colour scale) (pH1.0-14.0) -10BKT	10BKT	304.20
PB-7650	INDICATOR PAPER PH 3.8 TO 5.4 -100LVS	10BKT	499.20
PB-7651	INDICATOR PAPER WIDE RANGE (With colour scale) (pH2.0-10.5)-10BKT	10BKT	304.20
PB-7652	INDIGO CARMINE AR -100GM	100GM	1482.00
PB-7653	INDIGO CARMINE AR -25GM	25GM	468.00
PB-7654	INDIUM SULPHATE 99.9%-10GM	10GM	3276.00

CODE	PRODUCT	PACKING	PRICE
PB-7655	INDIUM SULPHATE 99.9%-25GM	25GM	8424.00
PB-7656	INDOLE AR (For estimation of DNA)-100GM	100GM	2379.00
PB-7657	INDOLE AR (For estimation of DNA)-10GM	10GM	296.40
PB-7658	INDOLE-3-ACETIC ACID FOR BIOCHEMISTRY -25GM	25GM	2,355.60
PB-7659	INDOLE-3-ACETIC ACID FOR BIOCHEMISTRY -5GM	5GM	686.40
PB-7660	INDOLE-3-BUTYRIC ACID FOR BIOCHEMISTRY -25GM	25GM	2,909.40
PB-7661	INDOLE-3-BUTYRIC ACID FOR BIOCHEMISTRY -5GM	5GM	702.00
PB-7662	INOSINE FOR BIOCHEMISTRY -100GM	100GM	7,901.40
PB-7663	INOSINE FOR BIOCHEMISTRY -10GM	10GM	842.40
PB-7664	INOSINE FOR BIOCHEMISTRY -25GM	25GM	2,074.80
PB-7665	IODIC ACID AR 99%	100GM	6,520.80
PB-7666	IODINE (RESUBLIMED) AR-100GM	100GM	1716.00
PB-7667	IODINE (RESUBLIMED) AR-500GM	500GM	9516.00
PB-7668	IODINE (RESUBLIMED) LR-100GM	25GM	592.80
PB-7669	IODINE (RESUBLIMED) LR-100GM	100GM	1435.20
PB-7670	IODINE (RESUBLIMED) LR-500GM	500GM	9048.00
PB-7671	IODINE GRAM'S (GRAM'S IODINE)-100GM	100GM	4,789.20
PB-7672	IODINE GRAM'S (GRAM'S IODINE)-25GM	25GM	1,248.00
PB-7673	IODINE GRAMS STAINING SOLUTION -125ML	125ML	288.60
PB-7674	IODINE MONOBROMIDE-100GM	100GM	9,016.80
PB-7675	IODINE MONOCHLORIDE SOLUTION (WIJ'S SOLUTION)	250ML	780.00
PB-7676	IODINE SOLUTION 0.01 Normal volumetric solution -500ML	500ML	694.20
PB-7677	ODOFORM LR-250GM	250GM	10,951.20
PB-7678	IODOPHOR (DISINFECTANT)-1LTR	1LTR	1170.00
PB-7679	IODOPHOR (DISINFECTANT)-5LTR	5LTR	5304.00
PB-7680	IRIDIUM TRICHLORIDE FOR SYNTHESIS (IR 46%)	1GM	11232.00
PB-7681	IRON (METAL) POWDER ELECTROLYTIC -1KG	1KG	1,201.20
PB-7682	IRON (METAL) POWDER ELECTROLYTIC -5KG	5KG	5,616.00
PB-7683	ISATIN AR-100GM	100GM	6396.00
PB-7684	ISATIN AR-25GM	25GM	1716.00
PB-7685	iso- AMYL ACETATE FOR SYNTHESIS	500ML	733.20
PB-7686	iso- AMYL ACETATE FOR SYNTHESIS	2.5LTR	3,049.80
PB-7687	ISO-AMYL ALCOHOL AR -2.5LTR	2.5LTR	4,024.80
PB-7688	ISO-AMYL ALCOHOL AR -500ML	500ML	943.80
PB-7689	iso-BUTANOL AR 99%	500ML	561.60
PB-7690	iso-BUTANOL AR 99%	2.5LTR	2,145.00
PB-7691	iso-BUTANOL FOR SYNTHESIS 98.5%	500ML	444.60
PB-7692	iso-BUTANOL FOR SYNTHESIS 98.5%	2.5LTR	1,786.20
PB-7693	ISO-BUTYL ACETATE FOR SYNTHESIS	500ML	717.60
PB-7694	ISO-BUTYL ACETATE FOR SYNTHESIS	2.5LTR	3,322.80
PB-7695	ISONIAZIDE PURE 99% (Isonicotinic Acid Hydrazide)	100GM	1014.00
PB-7696	ISONIAZIDE PURE 99% (Isonicotinic Acid Hydrazide)	500GM	4680.00
PB-7697	ISONICOTONIC ACID -100GM	100GM	1177.80
PB-7698	ISONICOTONIC ACID -500GM	500GM	3744.00
PB-7699	ISO-PROPYL ACETATE LR	500ML	655.20
PB-7700	ISO-PROPYL ACETATE LR	2.5LTR	2776.80
PB-7701	iso-PROPYL ALCOHOL AR (IPA)-2.5LTR	2.5LTR	1591.20
PB-7702	iso-PROPYL ALCOHOL AR (IPA)-500ML	500ML	468.00
PB-7703	iso-PROPYL ALCOHOL HPLC SPECTROSCOPY	1LTR	967.20
PB-7704	iso-PROPYL ALCOHOL HPLC SPECTROSCOPY	2.5LTR	1942.20
PB-7705	iso-PROPYL ALCOHOL LR (IPA)-2.5LTR	2.5LTR	1466.40
PB-7706	iso-PROPYL ALCOHOL LR (IPA)-500ML	500ML	405.60
PB-7707	iso-PROPYL MYRISTATE LR-2.5LTR	2.5LIT	4836.00
PB-7708	iso-PROPYL MYRISTATE LR-500ML	500ML	1092.00
PB-7709	iso-PROPYLAMINE LR -2.5LTR	2.5LTR	3946.80
PB-7710	iso-PROPYLAMINE LR -50ML	500ML	858.00

CODE	PRODUCT	PACKING	PRICE
PB-7711	ISO-PROPYL-b-D-1-THIOGALACTOPYRANOSIDE (IPTG)-1GM	1GM	1201.20
PB-7712	ISO-PROPYL-b-D-1-THIOGALACTOPYRANOSIDE (IPTG)-250MG	250MG	343.20
PB-7713	ISO-PROPYL-b-D-1-THIOGALACTOPYRANOSIDE (IPTG)-5GM	5GM	5148.00
PB-7714	ITACONIC ACID -500GM	500GM	1154.40
PB-7715	J.S.B. STAIN SOLUTION NO.1	125ML	156.00
PB-7716	J.S.B. STAIN SOLUTION NO.2	125ML	156.00
PB-7717	JACK BEAN MEAL-100GM	100GM	374.40
PB-7718	JACK BEAN MEAL-500GM	500GM	1762.80
PB-7719	JANUS GREEN B for MicroscopyC. I. No. 11051-25GM	25GM	5226.00
PB-7720	JANUS GREEN B for Microscopy C. I. No. 11050-10GM	10GM	2379.00
PB-7721	JENNER'S STAIN FOR MICROSCOPY	25GM	787.80
PB-7722	JENNER'S STAIN FOR MICROSCOPY	100GM	2496.00
PB-7723	KAISER'S GLYCEROL -GENTAIN-100GM	100GM	187.20
PB-7724	KALIGNOST AR (Sodium Tetraphenyl Boron)-100GM	100GM	10264.80
PB-7725	KALIGNOST AR (Sodium Tetraphenyl Boron)-10GM	10GM	1177.80
PB-7726	KAOLIN LR-500GM	500GM	335.40
PB-7727	KARL FISCHER REAGENT Pyridine Free-500ML	500ML	2496.00
PB-7728	KIESELGUHR (purified white)-10KG	10KG	9204.00
PB-7729	KIESELGUHR (purified white)-1KG	1KG	1014.00
PB-7730	KINETIN PURISS CHR-10GM	10GM	5,756.40
PB-7731	KINETIN PURISS CHR-1GM	1GM	592.80
PB-7732	KINETIN PURISS CHR-250MG	250MG	249.60
PB-7733	KOVAC'S INDOLE REAGENT-100ML	100ML	226.20
PB-7734	L(-) SORBOSE FOR BIOCHEMISTRY-100GM	100GM	3,042.00
PB-7735	L(-) SORBOSE FOR BIOCHEMISTRY-25GM	25GM	1,201.20
PB-7736	L(+)-ARABINOSE -25GM	25GM	1,458.60
PB-7737	L(+)-ARABINOSE-10GM	10GM	803.40
PB-11406	LAB SURFACE CLEANING SOLUTION	5LTR	6,773.00
PB-7738	LACTIC ACID AR-2.5LTR	2.5LTR	3,744.00
PB-7739	LACTIC ACID AR-500ML	500ML	967.20
PB-7740	LACTIC ACID LR-2.5LTR	2.5LTR	3,541.20
PB-7741	LACTIC ACID LR-500ML	500ML	826.80
PB-7742	LACTOPHENOL (COTTON BLUE) FOR MICROSCOPY-500ML	500ML	429.00
PB-7743	LACTOSE (MONOHYDRATE) AR-500GM	500GM	951.60
PB-7744	LACTOSE (MONOHYDRATE)-500GM	500GM	787.80
PB-7745	L-ALANINE FOR BIOCHEMISTRY-100GM	100GM	1,084.20
PB-7746	L-ALANINE FOR BIOCHEMISTRY-25GM	25GM	288.60
PB-7747	LANOLIN ANHYDROUS-500GM	500GM	2,355.60
PB-7748	LANTHANUM CHLORIDE AR -100GM	100GM	2652.00
PB-7749	LANTHANUM CHLORIDE AR-500GM	500GM	14976.00
PB-7750	LANTHANUM NITRATE AR -100GM	100GM	3,954.60
PB-7751	LANTHANUM NITRATE AR -500GM	500GM	19,000.80
PB-7752	LANTHANUM OXIDE AR-100GM	100GM	2,636.40
PB-7753	LANTHANUM OXIDE AR-500GM	500GM	10608.00
PB-7754	LANTHANUM CARBOANTE AR-100GM	100GM	6240.00
PB-7755	LANTHANUM CARBOANTE AR-25GM	25GM	1,669.20
PB-7756	L-ARGININE FOR BIOCHEMISTRY -100GM	100GM	1,045.20
PB-7757	L-ARGININE FOR BIOCHEMISTRY -25GM	25GM	319.80
PB-7758	L-ARGININE MONOHYDROCHLORIDE -100GM	100GM	1,146.60
PB-7759	L-ARGININE MONOHYDROCHLORIDE -25GM	25GM	343.20
PB-7760	L-ASCORBIC ACID AR FOR BIOCHEMISTRY-100GM	100GM	936.00
PB-7761	L-ASCORBIC ACID AR FOR BIOCHEMISTRY-500GM	500GM	4212.00
PB-7762	L-ASCORBIC ACID LR-100GM	100GM	702.00
PB-7763	L-ASCORBIC ACID LR-500GM	500GM	3276.00
PB-7764	L-ASPARGINE FOR BIOCHEMISTRY -100GM	100GM	1,318.20
PB-7765	L-ASPARGINE FOR BIOCHEMISTRY-25GM	25GM	390.00

CODE	PRODUCT	PACKING	PRICE
PB-7766	L-ASPARTIC ACID FOR BIOCHEMISTRY 100GM	100GM	483.60
PB-7767	L-ASPARTIC ACID FOR BIOCHEMISTRY 25GM	25GM	210.60
PB-7768	LAURIC ACID PURE (Dodecanoic acid)-500GM	500GM	655.20
PB-7769	L-CYSTEINE FOR BIOCHEMISTRY -25GM	25GM	663.00
PB-7770	L-CYSTEINE FOR BIOCHEMISTRY -5GM	5GM	218.40
PB-7771	L-CYSTEINE HYDROCHLORIDE (MONOHYDRATE)-100GM	100GM	1,271.40
PB-7772	L-CYSTEINE HYDROCHLORIDE (MONOHYDRATE)-25GM	25GM	358.80
PB-7773	L-CYSTEINE HYDROCHLORIDE (MONOHYDRATE)-500GM	500GM	4,157.40
PB-7774	L-CYSTINE FOR BIOCHEMISTRY -100GM	100GM	1,138.80
PB-7775	L-CYSTINE FOR BIOCHEMISTRY -25GM	25GM	358.80
PB-7776	L-DOPA 99+% FOR BIOCHEMISTRY	5GM	1,177.80
PB-7777	L-DOPA 99+% FOR BIOCHEMISTRY	25GM	5,132.40
PB-7778	LEAD (METAL) FOIL -500GM	500GM	2184.00
PB-7779	LEAD (METAL) FOIL AR-500GM	500GM	9984.00
PB-7780	LEAD (METAL) GRANULAR-500GM	500GM	1263.60
PB-7781	LEAD ACETATE (TRIHYDRATE) AR 99.5%	500GM	873.60
PB-7782	LEAD ACETATE (TRIHYDRATE)-500GM	500GM	702.00
PB-7783	LEAD ACETATE BASIC ANHYDROUS-1KG	1KG	1,731.60
PB-7784	LEAD ACETATE BASIC ANHYDROUS-2.5KG	2.5KG	4,024.80
PB-7785	LEAD ACETATE BASIC ANHYDROUS-5KG	5KG	7,207.20
PB-7786	LEAD BROMIDE FOR SYNTHESIS-500GM	500GM	3432.00
PB-7787	LEAD CARBONATE AR-250GM	250GM	6708.00
PB-7788	LEAD CARBONATE LR-500GM	500GM	1326.00
PB-7789	LEAD CHLORIDE-500GM	500GM	1,068.60
PB-7790	LEAD CHROMATE AR-100GM	100GM	1,068.60
PB-7791	LEAD CHROMATE AR-250GM	250GM	2,168.40
PB-7792	LEAD CHROMATE LR-500GM	500GM	1,177.80
PB-7793	LEAD DIOXIDE AR-250GM	250GM	3900.00
PB-7794	LEAD DIOXIDE LR-500GM	500GM	1716.00
PB-7795	LEAD MONOXIDE (LITHARGE)-1KG	1KG	1669.20
PB-7796	LEAD MONOXIDE (LITHARGE)-500GM	500GM	873.60
PB-7797	LEAD MONOXIDE AR-250GM	250GM	4524.00
PB-7798	LEAD NITRATE AR -500GM	500GM	858.00
PB-7799	LEAD NITRATE PURE -500GM	500GM	717.60
PB-7800	LEAD OXIDE (RED LEAD) -500GM	500GM	920.40
PB-7801	LEAD POWDER (LAB)-500GM	500GM	1014.00
PB-7802	LEAD STEARATE PURE	500GM	702.00
PB-7803	LEAD SULPHATE PURE-500GM	500GM	780.00
PB-7804	LEAD THIOCYANATE PURE 98%-100GM	100GM	1,942.20
PB-7805	LEAD THIOCYANATE PURE 98%-500GM	500GM	8,112.00
PB-7806	LEISHMANS STAIN FOR MICROSCOPY-100GM	100GM	2262.00
PB-7807	LEISHMANS STAIN FOR MICROSCOPY-25GM	25GM	592.80
PB-7808	LEISHMANS STAINING SOLUTION-250ML	250ML	343.20
PB-7809	L-GLUTAMIC ACID -100GM	100GM	296.40
PB-7810	L-GLUTAMIC ACID -250GM	250GM	592.80
PB-7811	L-GLUTAMIC ACID -1KG	1KG	1,903.20
PB-7812	L-GLUTAMIC ACID MONO SODIUM SALT-100GM	100GM	218.40
PB-7813	L-GLUTAMIC ACID MONO SODIUM SALT-500GM	500GM	670.80
PB-7814	L-GLUTAMIC ACID MONO SODIUM SALT-5KG	5KG	5,413.20
PB-7815	L-GLUTAMINE FOR BIOCHEMISTRY-100GM	100GM	1,435.20
PB-7816	L-GLUTAMINE FOR BIOCHEMISTRY-25GM	25GM	452.40
PB-7817	L-HISTIDINE FOR BIOCHEMISTRY -100GM	100GM	3151.20
PB-7818	L-HISTIDINE FOR BIOCHEMISTRY -25GM	25GM	1170.00
PB-7819	L-HISTIDINE MONO HYDROCHLORIDE FOR BIOCHEMISTRY-100GM	100GM	4056.00
PB-7820	L-HISTIDINE MONO HYDROCHLORIDE FOR BIOCHEMISTRY-25GM	25GM	1248.00
PB-7821	L-HISTIDINE MONO HYDROCHLORIDE FOR BIOCHEMISTRY-500GM	500GM	16380.00

CODE	PRODUCT	PACKING	PRICE
PB-7822	L-HYDROXYPROLINE FOR BIOCHEMISTRY-100GM	100GM	6864.00
PB-7823	L-HYDROXYPROLINE FOR BIOCHEMISTRY-25GM	25GM	2262.00
PB-7824	L-HYDROXYPROLINE FOR BIOCHEMISTRY-5GM	5GM	717.60
PB-7825	LIGHT GREEN FOR MICROSCOPY-100GM	100GM	4368.00
PB-7826	LIGHT GREEN FOR MICROSCOPY-25GM	25GM	1450.80
PB-7827	LIME WATER	500ML	195.00
PB-7828	L-ISO-LEUCINE FOR BIOCHEMISTRY -25GM	25GM	624.00
PB-7829	L-ISO-LEUCINE FOR BIOCHEMISTRY -5GM	5 GM	195.00
PB-7830	LITHIUM ACETATE AR-250GM	250GM	2,979.60
PB-7831	LITHIUM ACETATE LR	250GM	2,152.80
PB-7832	LITHIUM ALUMINIUM HYDRIDE (LAH) POWDER,-500GM	500GM	84240.00
PB-7833	LITHIUM BROMIDE-500GM	500GM	4680.00
PB-7834	LITHIUM CARBONATE AR-100GM	100GM	1263.60
PB-7835	LITHIUM CARBONATE AR-250GM	250GM	2964.00
PB-7836	LITHIUM CARBONATE LR-250GM	250GM	2496.00
PB-7837	LITHIUM CARBONATE LR-500GM	500GM	4992.00
PB-7838	LITHIUM CHLORIDE AR (ANHYDROUS) -250GM	250GM	3978.00
PB-7839	LITHIUM CHLORIDE AR (ANHYDROUS)-100GM	100GM	1840.80
PB-7840	LITHIUM CHLORIDE LR (ANHYDROUS)-250GM	250GM	2886.00
PB-7841	LITHIUM CHLORIDE LR (ANHYDROUS)-500GM	500GM	5538.00
PB-7842	LITHIUM FLOURIDE 98%-500GM	500GM	6708.00
PB-7843	LITHIUM HYDROXIDE (MONOHYDRATE) -500GM	500GM	7956.00
PB-7844	LITHIUM HYDROXIDE AR (MONOHYDRATE)-100GM	100GM	2028.00
PB-7845	LITHIUM HYDROXIDE AR (MONOHYDRATE)-500GM	500GM	8268.00
PB-7846	LITHIUM LACTATE LR-500GM	500GM	3,400.80
PB-7847	LITHIUM METABORATE (ANHYDROUS) AR 99% -100GM	100GM	5772.00
PB-7848	LITHIUM METABORATE (ANHYDROUS) AR 99%-250GM	250GM	11700.00
PB-7849	LITHIUM METABORATE (ANHYDROUS) LR-250GM	250GM	9906.00
PB-7850	LITHIUM SULPHATE (MONO) AR-100GM	100GM	1248.00
PB-7851	LITHIUM SULPHATE (MONO) AR-250GM	250GM	2808.00
PB-7852	LITHIUM SULPHATE (MONO) LR-250GM	250GM	2184.00
PB-7853	LITHIUM SULPHATE (MONO) LR-500GM	500GM	4212.00
PB-7854	LITMUS (pH INDICATOR) SOLUTION	125ML	171.60
PB-7855	LITMUS BLUE INDICATOR PAPER-10BKTS	10 BKTS	312.00
PB-7856	LITMUS BLUE SOLUTION-125ML	125ML	156.00
PB-7857	LITMUS INDICATOR LR-100GM	100GM	2340.00
PB-7858	LITMUS INDICATOR LR-10GM	10GM	390.00
PB-7859	LITMUS INDICATOR LR-25GM	25GM	702.00
PB-7860	LITMUS RED INDICATOR PAPER-10BKTS	10 BKTS	312.00
PB-7861	LITMUS RED SOLUTION-125ML	125ML	140.40
PB-7862	LIVER EXTRACT POWDER-500GM	500GM	1,872.00
PB-7863	L-LEUCINE FOR BIOCHEMISTRY-100GM	100GM	1544.40
PB-7864	L-LEUCINE FOR BIOCHEMISTRY-25GM	25GM	468.00
PB-7865	L-LEUCINE FOR BIOCHEMISTRY-500GM	500GM	7488.00
PB-7866	L-LYSINE MONOHYDROCHLORIDE -100GM	100GM	390.00
PB-7867	L-LYSINE MONOHYDROCHLORIDE -500GM	500GM	1,638.00
PB-7868	L-METHIONINE FOR BIOCHEMISTRY -100GM	100GM	1,326.00
PB-7869	L-METHIONINE FOR BIOCHEMISTRY -500GM	500GM	6,240.00
PB-7870	L-METHIONINE FOR BIOCHEMISTRY-25GM	25GM	418.08
PB-7871	L-ORNITHINE MONOHYDROCHLORIDE-100GM	100GM	4914.00
PB-7872	L-ORNITHINE MONOHYDROCHLORIDE-25GM	25GM	1248.00
PB-7873	L-ORNITHINE MONOHYDROCHLORIDE-5GM	5GM	327.60
PB-7874	L-PHENYLALANINE FOR BIOCHEMISTRY -100GM	100GM	1092.00
PB-7875	L-PHENYLALANINE FOR BIOCHEMISTRY -25GM	25GM	327.60
PB-7876	L-PHENYLALANINE FOR BIOCHEMISTRY -500GM	500GM	4446.00
PB-7877	L-PROLINE-100GM	100GM	1794.00

CODE	PRODUCT	PACKING	PRICE
PB-7878	L-PROLINE-25GM	25GM	468.00
PB-7879	L-PROLINE-5GM	5GM	140.40
PB-7880	L-RHAMNOSE FOR BIOCHEMISTRY -25GM	25GM	4524.00
PB-7881	L-RHAMNOSE FOR BIOCHEMISTRY -5GM	5GM	1076.40
PB-7882	L-SERINE FOR BIOCHEMISTRY -25GM	25GM	936.00
PB-7883	L-SERINE FOR BIOCHEMISTRY -5GM	5GM	234.00
PB-7884	L-THREONINE FOR BIOCHEMISTRY-100GM	100GM	3042.00
PB-7885	L-THREONINE FOR BIOCHEMISTRY-25GM	25GM	702.00
PB-7886	L-THREONINE FOR BIOCHEMISTRY-500GM	500GM	10296.00
PB-7887	L-TRYPTOPHAN -25GM	25GM	1825.20
PB-7888	L-TRYPTOPHAN -5GM	5GM	405.60
PB-7889	L-TYROSINE FOR BIOCHEMISTRY -100GM	100GM	1,638.00
PB-7890	L-TYROSINE FOR BIOCHEMISTRY -25GM	25GM	514.80
PB-7891	LUGOL'S IODINE SOLUTION FOR MICROSCOPY-125ML	125ML	421.20
PB-7892	LUGOL'S IODINE SOLUTION FOR MICROSCOPY-500ML	500ML	1,341.60
PB-7893	L-VALINE FOR BIOCHEMISTRY-100GM	100GM	1560.00
PB-7894	L-VALINE FOR BIOCHEMISTRY-1KG	1KG	11700.00
PB-7895	L-VALINE FOR BIOCHEMISTRY-25GM	25GM	468.00
PB-7896	LYSOL (CRESOL AND SOAP SOLUTION)	500ML	787.80
PB-7897	LYSOL (CRESOL AND SOAP SOLUTION)	5LTR	7332.00
PB-7898	M.T.T. TETRAZOLIUM AR-100MG	100MG	1,248.00
PB-7899	M.T.T. TETRAZOLIUM AR-1GM	1GM	10,264.80
PB-7900	M.T.T. TETRAZOLIUM AR-250MG	250MG	2,636.40
PB-7901	MAGENSIUM TRISILICATE HYDRATE POWDER LR	500GM	265.20
PB-7902	MAGNESIUM (METAL) POWDER -100GM	100GM	421.20
PB-7903	MAGNESIUM (METAL) POWDER -500GM	500GM	1575.60
PB-7904	MAGNESIUM (METAL) RIBBON -25GM	25GM	429.00
PB-7905	MAGNESIUM (METAL) TURNING-500GM	500GM	1365.00
PB-7906	MAGNESIUM ACETATE (TETRAHYDRATE)-500GM	500GM	842.40
PB-7907	MAGNESIUM ACETATE (TETRAHYDRATE)-5KG	5KG	6,169.80
PB-7908	MAGNESIUM ACETATE AR (TETRAHYDRATE)-250GM	250GM	2184.00
PB-7909	MAGNESIUM CARBONATE (LIGHT) AR-500GM	500GM	2,355.60
PB-7910	MAGNESIUM CARBONATE (LIGHT) LR-250GM	250GM	780.00
PB-7911	MAGNESIUM CARBONATE (LIGHT) LR-500GM	500GM	1,318.20
PB-7912	MAGNESIUM CHLORIDE AR (HEXAHYDRATE)-500GM	500GM	319.80
PB-7913	MAGNESIUM CHLORIDE AR (HEXAHYDRATE)-5KG	5KG	2,152.80
PB-7914	MAGNESIUM CHLORIDE LR (HEXAHYDRATE)-500GM	500GM	280.80
PB-7915	MAGNESIUM CHLORIDE LR (HEXAHYDRATE)-5KG	5KG	1,950.00
PB-7916	MAGNESIUM HYDROXIDE LR-1KG	1KG	717.60
PB-7917	MAGNESIUM NITRATE (HEXAHYDRATE) AR-500GM	500GM	421.20
PB-7918	MAGNESIUM NITRATE (HEXAHYDRATE) LR-500GM	500GM	304.20
PB-7919	MAGNESIUM OXIDE (HEAVY) LR	500GM	1,450.80
PB-7920	MAGNESIUM OXIDE (LIGHT) AR -500GM	500GM	1638.00
PB-7921	MAGNESIUM OXIDE (LIGHT) LR-500GM	500GM	1482.00
PB-7922	MAGNESIUM OXIDE (LIGHT) LR-5KG	5KG	14508.00
PB-7923	MAGNESIUM PERCHLORATE -100GM	100GM	3,603.60
PB-7924	MAGNESIUM PERCHLORATE -500GM	500GM	13,447.20
PB-7925	MAGNESIUM PERCHLORATE DRIED MAR 99%	100GM	4,024.80
PB-7926	MAGNESIUM PERCHLORATE DRIED MAR 99% -500GM	500GM	14,149.20
PB-7927	MAGNESIUM PHOSPHATE DIBASIC EXTRA PURE-500GM	500GM	787.80
PB-7928	MAGNESIUM STEARATE PRECIPITATED (FINE POWDER)-500GM	500GM	702.00
PB-7929	MAGNESIUM SULPHATE AR (HEPTAHYDRATE)-500GM	500GM	343.20
PB-7930	MAGNESIUM SULPHATE AR (HEPTAHYDRATE)-5KG	5KG	2340.00
PB-7931	MAGNESIUM SULPHATE-LR (HEPTAHYDRATE)-500GM	500GM	249.60
PB-7932	MAGNESIUM SULPHATE LR (HEPTAHYDRATE)-5KG	5KG	1497.60
PB-7933	MAGNESON I AR Sensitivity detects 1 ppm Mg	100GM	2184.00

CODE	PRODUCT	PACKING	PRICE
PB-7934	MAGNESON I AR Sensitivity detects 1 ppm Mg -25GM	25GM	624.00
PB-7935	MAGNESON II AR -100GM	100GM	2964.00
PB-7936	MAGNESON II AR -25GM	25GM	936.00
PB-7937	MAGNESSIUM PERCHLORATE (HEXAHYDRATE)-500GM	500GM	6,793.80
PB-7938	MALACHITE GREEN FOR MICROSCOPY-100GM	100GM	546.00
PB-7939	MALACHITE GREEN FOR MICROSCOPY-1KG	1KG	3900.00
PB-7940	MALACHITE GREEN FOR MICROSCOPY-25GM	25GM	234.00
PB-7941	MALACHITE GREEN SOLUTION-125ML	125ML	195.00
PB-7942	MALEIC ACID AR-100GM	100GM	319.80
PB-7943	MALEIC ACID AR-500GM	500GM	1,349.40
PB-7944	MALEIC ACID FOR SYNTHESIS-2.5KG	2.5KG	3900.00
PB-7945	MALEIC ACID FOR SYNTHESIS-500GM	500GM	889.20
PB-7946	MALEIC ANHYDRIDE -500GM	500GM	663.00
PB-7947	MALEIC ANHYDRIDE -5KG	5KG	6,240.00
PB-7948	MALEIC HYDRAZIDE-100GM	100GM	811.20
PB-7949	MALEIC HYDRAZIDE-1KG	1KG	7488.00
PB-7950	MALONIC ACID AR -100GM	100GM	663.00
PB-7951	MALONIC ACID AR -1KG	1KG	4,992.00
PB-7952	MALONIC ACID AR -250GM	250GM	1,450.80
PB-7953	MALONIC ACID FOR SYNTHESIS-1KG	1KG	4,157.40
PB-7954	MALONIC ACID FOR SYNTHESIS-250GM	250GM	1,209.00
PB-7955	MALT EXTRACT POWDER FOR BACTERIOLOGY-500GM	500GM	1014.00
PB-7956	MALTO DEXTRINE	500GM	288.60
PB-7957	MALTOSE MONOHYDRATE FOR BACTERIOLOGY-100GM	100GM	358.80
PB-7958	MALTOSE MONOHYDRATE FOR BACTERIOLOGY-250GM	250GM	780.00
PB-7959	MALTOSE MONOHYDRATE FOR BACTERIOLOGY-500GM	500GM	1,450.80
PB-7960	MANGANESE (II) ACETATE AR (TETRAHYDRATE) -500GM	500GM	663.00
PB-7961	MANGANESE (II) ACETATE(TETRAHYDRATE) LR-500GM	500GM	475.80
PB-7962	MANGANESE (II) CHLORIDE AR (TETRAHYDRATE)-500GM	500GM	655.20
PB-7963	MANGANESE (II) CHLORIDE PURIFEID (TETRAHYDRATE)-500GM	500GM	624.00
PB-7964	MANGANESE (II) CHLORIDE PURIFEID (TETRAHYDRATE)-5KG	5KG	5928.00
PB-7965	MANGANESE (II) SULPHATE AR-500GM	500GM	780.00
PB-7966	MANGANESE (II) SULPHATE PURIFIED (MONOHYDRATE)-500GM	500GM	546.00
PB-7967	MANGANESE (II) SULPHATE PURIFIED (MONOHYDRATE)-5KG	5KG	4836.00
PB-7968	MANGANESE CARBONATE (MANGANOUS CARBONATE) -500GM	500GM	499.20
PB-7969	MANGANESE DIOXIDE AR-500GM	500GM	1,287.00
PB-7970	MANGANESE DIOXIDE TECH.-500GM	500GM	312.00
PB-7971	MANGANESE DIOXIDE TECH.-5KG	5KG	2652.00
PB-7972	MANGANESE POWDER (LAB)-250GM	250GM	1560.00
PB-7973	MAY & GRUNWALD'S SOLUTION-125ML	125ML	280.80
PB-7974	MAY AND GRUNWALD'S STAIN FOR MICROSCOPY-25GM	25GM	616.20
PB-7975	m-CRESOL FOR SYNTHESIS-2.5LTR	2.5LTR	7,488.00
PB-7976	m-CRESOL FOR SYNTHESIS-500ML	500ML	1,591.20
PB-7977	m-CRESOL PURPLE INDICATOR-1GM	1GM	374.40
PB-7978	m-CRESOL PURPLE INDICATOR-5GM	5GM	1,591.20
PB-7979	MEAT EXTRACT POWDER-500GM	500GM	1,762.80
PB-7980	MELAMINE PURE-500GM	500GM	483.60
PB-7981	MENADIONE FOR BIOCHEMISTRY	25GM	1,528.80
PB-7982	MENADIONE FOR BIOCHEMISTRY-100GM	100GM	4758.00
PB-7983	MENTHOL CRYSTALS-100GM	100GM	1,357.20
PB-7984	MERCURIC ACETATE AR-100GM	100GM	3900.00
PB-7985	MERCURIC ACETATE AR-250GM	250GM	10108.80
PB-7986	MERCURIC ACETATE AR-50GM	50GM	2106.00
PB-7987	MERCURIC ACETATE LR-100GM	100GM	3432.00
PB-7988	MERCURIC ACETATE LR-500GM	250GM	8424.00
PB-7989	MERCURIC ACETATE LR-50GM	50GM	1,872.00

CODE	PRODUCT	PACKING	PRICE
PB-7990	MERCURIC BROMIDE AR-100GM	100GM	9204.00
PB-7991	MERCURIC BROMIDE AR-25GM	25GM	2340.00
PB-7992	MERCURIC CHLORIDE AR-100GM	100GM	3744.00
PB-7993	MERCURIC CHLORIDE AR-250GM	250GM	8361.60
PB-7994	MERCURIC CHLORIDE-100GM	100GM	3588.00
PB-7995	MERCURIC CHLORIDE-250GM	250GM	8580.00
PB-7996	MERCURIC CHLORIDE-500GM	500GM	15990.00
PB-7997	MERCURIC IODIDE RED AR-100GM	100GM	3744.00
PB-7998	MERCURIC IODIDE RED AR-500GM	250GM	9360.00
PB-7999	MERCURIC IODIDE RED LR-100GM	100GM	3588.00
PB-8000	MERCURIC IODIDE RED LR-500GM	250GM	8736.00
PB-8001	MERCURIC NITRATE (HYDRATE) AR-100GM	100GM	3900.00
PB-8002	MERCURIC NITRATE (HYDRATE) AR-250GM	250GM	9672.00
PB-8003	MERCURIC NITRATE LR-100GM	100GM	3744.00
PB-8004	MERCURIC NITRATE LR-250GM	250GM	9048.00
PB-8005	MERCURIC NITRATE LR-500GM	500GM	15444.00
PB-8006	MERCURIC OXIDE RED AR-100GM	100GM	3900.00
PB-8007	MERCURIC OXIDE RED AR-500GM	500GM	17628.00
PB-8008	MERCURIC OXIDE RED LR-100GM	100GM	3588.00
PB-8009	MERCURIC OXIDE RED LR-500GM	500GM	16848.00
PB-8010	MERCURIC OXIDE YELLOW AR-100GM	100GM	3900.00
PB-8011	MERCURIC OXIDE YELLOW LR-100GM	100GM	3588.00
PB-8012	MERCURIC OXIDE YELLOW LR-500GM	500GM	16848.00
PB-8013	MERCURIC SULPHATE -100GM	100GM	3510.00
PB-8014	MERCURIC SULPHATE -250GM	250GM	7488.00
PB-8015	MERCURIC SULPHATE -500GM	500GM	13884.00
PB-8016	MERCURIC SULPHATE AR-100GM	100GM	3666.00
PB-8017	MERCURIC SULPHATE AR-250GM	250GM	8112.00
PB-8018	MERCURIC THIOCYANATE AR-100GM	100GM	4992.00
PB-8019	MERCURIC THIOCYANATE AR-25GM	25GM	1248.00
PB-8020	MERCUROCHROME(MERCURY DIBROMOFLUORESCEIN) 97.5%	25GM	1201.20
PB-8021	MERCUROUS CHLORIDE AR-100GM	100GM	4524.00
PB-8022	MERCUROUS CHLORIDE-100GM	100GM	4212.00
PB-8023	MERCUROUS CHLORIDE-500GM	500GM	19968.00
PB-8024	MERCUROUS NITRATE AR-100GM	100GM	4524.00
PB-8025	MERCUROUS NITRATE AR-500GM	500GM	10764.00
PB-8026	MERCUROUS NITRATE LR-100GM	100GM	4368.00
PB-8027	MERCUROUS NITRATE LR-500GM	500GM	10452.00
PB-8028	MERCURY (METAL) AR-100GM	100GM	3276.00
PB-8029	MERCURY (METAL) AR-250GM	250GM	7566.00
PB-8030	MERCURY (METAL) AR-500GM	500GM	14196.00
PB-8031	MERCURY (METAL) PURE-100GM	100GM	3120.00
PB-8032	MERCURY (METAL) PURE-250GM	250GM	6942.00
PB-8033	MERCURY (METAL) PURE-500GM	500GM	13650.00
PB-8034	MESITYLENE FOR SYNTHESIS 98%	500ML	1248.00
PB-8035	MESITYLENE FOR SYNTHESIS 98%	2.5LTR	5304.00
PB-8036	meso-INOSITOL FOR BIOCHEMISTRY -100GM	100GM	1,248.00
PB-8037	meso-INOSITOL FOR BIOCHEMISTRY -1KG	1KG	10,951.20
PB-8038	meso-INOSITOL FOR BIOCHEMISTRY -25GM	25GM	452.40
PB-8039	METANIL YELLOW AR-100GM	100GM	452.40
PB-8040	METANIL YELLOW AR-25GM	25GM	210.60
PB-8041	meta-PHOSPHORIC ACID (GLACIAL STICKS)-500GM	500GM	3744.00
PB-8042	meta-PHOSPHORIC ACID AR (GLACIAL STICKS)-100GM	100GM	4719.00
PB-8043	meta-PHOSPHORIC ACID AR (GLACIAL STICKS)-500GM	500GM	16364.40
PB-8044	METHACRYLIC ACID FOR SYNTHESIS	500ML	998.40
PB-8045	METHACRYLIC ACID FOR SYNTHESIS	2.5LTR	4024.80

CODE	PRODUCT	PACKING	PRICE
PB-8046	METHANESULPHONIC ACID FOR SYNTHESIS-2.5LTR	2.5LTR	5959.20
PB-8047	METHANESULPHONIC ACID FOR SYNTHESIS-500ML	500ML	1528.80
PB-8048	METHANESULPHONYL CHLORIDE FOR SYNTHESIS 99%	500ML	1411.80
PB-8049	METHANESULPHONYL CHLORIDE FOR SYNTHESIS 99%	2.5LTR	6520.80
PB-8050	METHANOL (SPECIALLY DRIED) AR (End use certificate required)	500ML	390.00
PB-8051	METHANOL (SPECIALLY DRIED) AR (End use certificate required)	2.5LTR	1271.40
PB-8051	METHANOL FOR GENERAL LABORATORY GRADE	500ML	742.00
PB-8052	METHANOL "GRADIENT GRADE" FOR HPLC-1LTR	1LTR	585.00
PB-8053	METHANOL "GRADIENT GRADE" FOR HPLC-2.5LTR	2.5LTR	1201.20
PB-8054	METHANOL AR-2.5LTR	2.5LTR	780.00
PB-8055	METHANOL AR-500ML	500ML	288.60
PB-8056	METHANOL FOR HPLC-1LTR	1LTR	499.20
PB-8057	METHANOL FOR HPLC-2.5LTR	2.5LTR	889.20
PB-8058	METHANOL LR-2.5LTR	2.5LTR	702.00
PB-8059	METHANOL LR-500ML	500ML	249.60
PB-8060	METHYL ACETATE FOR SYNTHESIS	500ML	663.00
PB-8061	METHYL ACETATE FOR SYNTHESIS	2.5LTR	2,909.40
PB-8062	METHYL ACRYLATE FOR SYNTHESIS	500ML	873.60
PB-8063	METHYL ACRYLATE FOR SYNTHESIS	2.5LTR	3,884.40
PB-8064	METHYL AREEN For microscopical staining-10GM	10GM	2,652.00
PB-8065	METHYL AREEN For microscopical staining-25GM	25GM	5,460.00
PB-8066	METHYL BENZOATE LR (Solvent for Embedding)-250ML	250ML	663.00
PB-8067	METHYL BENZOATE LR (Solvent for Embedding)-500ML	500ML	1,084.20
PB-8068	METHYL BLUE FOR MICROSCOPY-100GM	100GM	3,120.00
PB-8069	METHYL BLUE FOR MICROSCOPY-25GM	25GM	1,014.00
PB-8070	METHYL CELLULOSE (HIGH VISCOSITY) 4000 CPS-500GM	500GM	3,588.00
PB-8071	METHYL CELLULOSE (LOW VISCOSITY) 350-550 CPS-500GM	500GM	3,322.80
PB-8072	METHYL CHLOROFORMATE FOR SYNTHESIS 98%	500ML	826.80
PB-8073	METHYL CHLOROFORMATE FOR SYNTHESIS 98%	2.5LTR	3,463.20
PB-8074	METHYL EUGENOL FOR SYNTHESIS 98%	100ML	1,942.20
PB-8075	METHYL EUGENOL FOR SYNTHESIS 98%	500ML	9,289.80
PB-8076	METHYL FORMATE FOR SYNTHESIS 98%	500ML	663.00
PB-8077	METHYL FORMATE FOR SYNTHESIS 98%	2.5LTR	2,909.40
PB-8078	METHYL IODIDE FOR SYNTHESIS 99%	100ML	3,603.60
PB-8079	METHYL IODIDE FOR SYNTHESIS 99%	250ML	8,876.40
PB-8080	METHYL ORANGE INDICATOR SOLUTION-125ML	125ML	140.40
PB-8081	METHYL ORANGE INDICATOR-100GM	100GM	592.80
PB-8082	METHYL ORANGE INDICATOR-25GM	25GM	218.40
PB-8083	METHYL RED (pH INDICATOR SOLUTION)-125ML	125ML	140.40
PB-8084	METHYL RED INDICATOR AR-100GM	100GM	1,154.40
PB-8085	METHYL RED INDICATOR AR-25GM	25GM	358.80
PB-8086	METHYL SALICYLATE FOR SYNTHESIS	500ML	904.80
PB-8087	METHYL SALICYLATE FOR SYNTHESIS	2.5LTR	4,024.80
PB-8088	METHYL THYMOL BLUE PH INDICATOR AR	5GM	202.80
PB-8089	METHYL THYMOL BLUE PH INDICATOR AR	25GM	889.20
PB-8090	METHYL TRIPHENYLPHOSPHONIUM BROMIDE FOR SYNTHESIS	100GM	1248.00
PB-8091	METHYL TRIPHENYLPHOSPHONIUM BROMIDE FOR SYNTHESIS	500GM	4446.00
PB-8092	METHYL VIOLET FOR STAINING SOLUTION -125ML	125 ML	163.80
PB-8093	METHYL VIOLET FOR MICROSCOPY -100GM	100GM	702.00
PB-8094	METHYL VIOLET FOR MICROSCOPY-25GM	25GM	249.60
PB-8095	METHYLAMINE SOLUTION 40%-2.5LTR	2.5LTR	1,068.60
PB-8096	METHYLAMINE SOLUTION 40%-500ML	500ML	249.60
PB-8097	METHYLAMMONIUM CHLORIDE FOR SYNTHESIS -1KG	1KG	1,482.00
PB-8098	METHYLAMMONIUM CHLORIDE FOR SYNTHESIS -250GM	250GM	436.80
PB-8099	METHYLENE BLUE (AQUEOUS)STAINING SOLUTION-125ML	125ML	163.80
PB-8100	METHYLENE BLUE ALKALINE (LOFFLER'S) STAINING SOLUTION)-125ML	125ML	187.20
PB-8101	METHYLENE BLUE FOR MICROSCOPY-100GM	100GM	2,152.80

CODE	PRODUCT	PACKING	PRICE
PB-8102	METHYLENE BLUE FOR MICROSCOPY-25GM	25GM	631.80
PB-8103	METHYL-iso-BUTYL KETONE AR-2.5LTR	2.5LTR	2,636.40
PB-8104	METHYL-iso-BUTYL KETONE AR-500ML	500ML	592.80
PB-8105	METHYL-iso-BUTYL KETONE LR-2.5LTR	2.5LTR	2,355.60
PB-8106	METHYL-iso-BUTYL KETONE LR-500ML	500ML	530.40
PB-8107	METHYL-p-HYDROXYBENZOATE LR-500GM	500GM	1,279.20
PB-8108	METHYL-p-HYDROXYBENZOATE LR-5KG	5KG	12,058.80
PB-8109	METHYL-p-HYDROXYBENZOATE SODIUM SALT-500GM	500GM	1,450.80
PB-8110	METOL (For PhotoARaphic Purpose) (4-Methylaminophenol Sulphate) -100GM	100GM	1232.40
PB-8111	METOL (For PhotoARaphic Purpose) (4-Methylaminophenol Sulphate)-500GM	500GM	4680.00
PB-8112	MILLON'S REAGENT-125ML	125ML	1,450.80
PB-8113	MILLON'S REAGENT-500ML	500ML	5,678.40
PB-8114	MINTROLEUM AR-2.5LTR	2.5LTR	1,560.00
PB-8115	MINTROLEUM AR-500ML	500ML	452.40
PB-8116	MINTROLEUM LR-2.5LTR	2.5LIT	1,404.00
PB-8117	MINTROLEUM LR-500ML	500ML	390.00
PB-8118	m-NITROPHENOL INDICATOR	5GM	592.80
PB-8119	m-NITROPHENOL INDICATOR	25GM	2152.80
PB-8120	MOLECULAR SIEVES 3A X 1.5mm-250GM	250GM	733.20
PB-8121	MOLECULAR SIEVES 4A X 1.5mm-250GM	250GM	655.20
PB-8122	MOLECULAR SIEVES 5A X 1.5 mm-250GM	250GM	694.20
PB-8123	MOLYBDENUM METAL POWDER-100GM	100GM	2808.00
PB-8124	MOLYBDENUM DISULPHIDE POWDER -100GM	100GM	1794.00
PB-8125	MOLYBDENUM DISULPHIDE POWDER -500GM	500GM	8112.00
PB-8126	MOLYBDENUM TRIOXIDE AR-100GM	100GM	2,215.20
PB-8127	MOLYBDENUM TRIOXIDE AR-500GM	500GM	10,951.20
PB-8128	MOLYBDENUM TRIOXIDE LR-100GM	100GM	2,012.40
PB-8129	MOLYBDENUM TRIOXIDE LR-500GM	500GM	9,562.80
PB-8130	MOLYBDIC ACID AR-100GM	100GM	1,661.40
PB-8131	MOLYBDIC ACID AR-500GM	500GM	6,793.80
PB-8132	MOLYBDIC ACID LR-100GM	100GM	1,450.80
PB-8133	MOLYBDIC ACID LR-500GM	500GM	5,959.20
PB-8134	MOLYCLEAN MA 01 ALKALINE (pH Value- 11-12)-500ML	500ML	280.80
PB-8135	MOLYCLEAN MA 01 ALKALINE (pH Value- 11-12)-5LTR	5LTR	1,302.60
PB-8136	MOLYCLEAN MA 02 NEUTRAL (pH Value- 6-8)-500ML	500ML	265.20
PB-8137	MOLYCLEAN MA 02 NEUTRAL (pH Value- 6-8)-5LTR	5LTR	1,786.20
PB-8138	MOLYCLEAN MA 03 PHOSPHATE FREE (Phosphate-NMT 0.002%)-5LTR	5LTR	1,778.40
PB-8139	MOLYCLEAN MA 03 PHOSPHATE FREE (Phosphate-NMT0.002%)-500ML	500ML	327.60
PB-8140	MOLYCLEAN MA 05 (NEUTRAL) PHOSPHATE FREE -500ML	500ML	265.20
PB-8141	MOLYCLEAN MA 05 (NEUTRAL) PHOSPHATE FREE -5LTR	5LTR	1,708.20
PB-8142	MOLYSOL 'E' AR	500ML	826.80
PB-8143	MOLYSOL 'E' FOR HPLC-500ML	500ML	3588.00
PB-8144	MOLYSOL 'E' FOR UV SPECTROSCOPY-500ML	500ML	3588.00
PB-8145	MONOTHIOGLYCEROL 90% -1KG	1KG	20,794.80
PB-8146	MONOTHIOGLYCEROL AR 98% - 1KG	1KG	29,125.20
PB-8147	MOPSO BUFFER (3-Morpholinoethane Sulphonic Acid)-50GM	50GM	3,190.20
PB-8148	MORPHOLINE LR	500ML	982.80
PB-8149	MORPHOLINE LR	2.5LTR	4680.00
PB-8150	MORPHOLINOETHANE SULFONIC ACID (MONOHYDRATE) (Mes Buffer)-100GM	100GM	4836.00
PB-8151	MORPHOLINOETHANE SULFONIC ACID (MONOHYDRATE) (Mes Buffer)-25GM	25GM	1404.00
PB-8152	MORPHOLINOPROPANE SULPHONIC ACID AR (Mops Buffer)-100GM	100GM	4,570.80
PB-8153	MORPHOLINOPROPANE SULPHONIC ACID AR (Mops Buffer)-25GM	25GM	1,801.80
PB-8154	MORPHOLINOPROPANE SULPHONIC ACID AR (Mops Buffer)-500GM	500GM	21,356.40
PB-8155	m-PHENYLENEDIAMINE -250GM	250GM	1068.60
PB-8156	MUCIC ACID (Galactaric acid)	100GM	4,711.20
PB-8157	MYRISTIC ACID 98%	500GM	663.00

CODE	PRODUCT	PACKING	PRICE
PB-8158	N- PHENYL THIOUREA	100GM	22620.00
PB-8159	N,N,-DIMETHYL PARAPHENYLANINEDIAMINE HEMI OXALATE -1GM	1GM	826.80
PB-8160	N,N,-DIMETHYL PARAPHENYLANINEDIAMINE HEMI OXALATE -5GM	5GM	3,744.00
PB-8161	N,N,N',N'-TETRAMETHYL ETHYLENEDIAMINE (TEMED)-100ML	100ML	998.40
PB-8162	N,N,N',N'-TETRAMETHYL ETHYLENEDIAMINE (TEMED)-250ML	250ML	1,591.20
PB-8163	N,N,N',N'-TETRAMETHYL ETHYLENEDIAMINE AR (TEMED)-100ML	100ML	1,209.00
PB-8164	N,N,N',N'-TETRAMETHYL ETHYLENEDIAMINE AR (TEMED)-250ML	250ML	1,950.00
PB-8165	N,N,N',N'-TETRAMETHYL-p-PHENYLENEDIAMINE DIHYDROCHLORIDE-25GM	25GM	9,984.00
PB-8166	N,N,N',N'-TETRAMETHYL-p-PHENYLENEDIAMINE DIHYDROCHLORIDE-5GM	5GM	2,184.00
PB-8167	N,N'-CARBONYLDIIMIDAZOLE (CDI) FOR BIOCHEMISTRY-100GM	100GM	2,074.80
PB-8168	N,N'-CARBONYLDIIMIDAZOLE (CDI) FOR BIOCHEMISTRY-25GM	25GM	764.40
PB-8169	N,N'-CARBONYLDIIMIDAZOLE (CDI) FOR BIOCHEMISTRY-500GM	500GM	7,909.20
PB-8170	N,N'-DICYCLOHEXYLCARBODIMIDE (DCC) 99% MIN FOR BIOCHEMISTRY-100GM	100GM	795.60
PB-8171	N,N'-DICYCLOHEXYLCARBODIMIDE (DCC) 99% MIN FOR BIOCHEMISTRY-500GM	500GM	2,355.60
PB-8172	N,N-DIETHYLANILINE LR 98.5%	500ML	1,271.40
PB-8173	N,N-DIETHYLANILINE LR 98.5%	2.5LTR	5,959.20
PB-8174	N,N-DIETHYL-p-PHENYLENEDIAMINE SULPHATE AR-100GM	100GM	1,591.20
PB-8175	N,N-DIISOPROPYL EHTHYLAMINE FOR SYNTHESIS-1LTR	1LTR	4,508.40
PB-8176	N,N-DIISOPROPYL EHTHYLAMINE FOR SYNTHESIS-500ML	500ML	2,215.20
PB-8177	N,N-DIISOPROPYL EHTHYLAMINE FOR SYNTHESIS	250ML	1,177.80
PB-8178	N,N-DIMETHYL ANILINE AR	500ML	826.80
PB-8179	N,N-DIMETHYL ANILINE AR	2.5LTR	3,603.60
PB-8180	N,N-DIMETHYL ANILINE FOR SYNTHESIS	500ML	663.00
PB-8181	N,N-DIMETHYL ANILINE FOR SYNTHESIS	2.5LTR	3,120.00
PB-8182	N,N-DIMETHYL IMIDAZOLIDINONE (DMI) -100GM	100GM	1,591.20
PB-8183	N,N-DIMETHYL IMIDAZOLIDINONE (DMI) -500GM	500GM	7,488.00
PB-8184	N,N-METHYLENE BISACRYLAMIDE AR 99% for Electrophoresis-100GM	100GM	2,152.80
PB-8185	N,N-METHYLENE BISACRYLAMIDE AR 99% for Electrophoresis-25GM	25GM	702.00
PB-8186	N,O-BIS-(TRIMETHYLSILYL) ACETAMIDE (BSA) FOR SYNTHESIS-100GM	100GM	2,698.80
PB-8187	N,O-BIS-(TRIMETHYLSILYL) ACETAMIDE (BSA) FOR SYNTHESIS-25GM	25GM	967.20
PB-8188	N,O-BIS-(TRIMETHYLSILYL) ACETAMIDE (BSA) FOR SYNTHESIS-500GM	500GM	10,951.20
PB-8189	N,O-BIS-(TRIMETHYLSILYL) TRIFLUORO ACETAMIDE (BSTFA) -100ML	100ML	7,488.00
PB-8190	N,O-BIS-(TRIMETHYLSILYL) TRIFLUORO ACETAMIDE (BSTFA) -25ML	25ML	2,215.20
PB-8191	N,O-BIS-(TRIMETHYLSILYL) TRIFLUORO ACETAMIDE (BSTFA)-5ML	5ML	592.80
PB-8192	N,O-DIMETHYL HYDROXYLAMINE HYDROCHLORIDE FOR SYNTHESIS-100GM	100GM	3,744.00
PB-8193	N,O-DIMETHYL HYDROXYLAMINE HYDROCHLORIDE FOR SYNTHESIS-25GM	25GM	1,037.40
PB-8194	N-1-NAPHTHYL ETHYLENE DIAMINE DIHYDROCHLORIDE AR-10GM	10GM	1747.20
PB-8195	N-1-NAPHTHYL ETHYLENE DIAMINE DIHYDROCHLORIDE AR-25GM	25GM	4056.00
PB-8196	N-1-NAPHTHYL ETHYLENE DIAMINE DIHYDROCHLORIDE AR-5GM	5GM	998.40
PB-8197	N-ACETYL-DL-TRYPTOPHAN-25GM	25GM	1,318.20
PB-8198	N-ACETYL-L-CYSTEINE FOR BIOCHEMISTRY-100GM	100GM	5,756.40
PB-8199	N-ACETYL-L-CYSTEINE FOR BIOCHEMISTRY-10GM	10GM	943.80
PB-8200	N-ACETYL-Y-BUTYROLACTONE FOR SYNTHESIS- 500GM	500GM	5,132.40
PB-8201	N-ACETYL-Y-BUTYROLACTONE FOR SYNTHESIS-100GM	100GM	1,443.00
PB-8202	n-AMYL ALCOHOL 99% For synthesis -2.5LTR	2.5LTR	5,686.20
PB-8203	n-AMYL ALCOHOL 99% For synthesis -500ML	500ML	2,012.40
PB-8204	n-AMYL ALCOHOL AR 99% - 500ML	500ML	2,355.60
PB-8205	n-AMYL ALCOHOL AR 99%-2.5LTR	2.5LTR	10,810.80
PB-8206	NAPHTHALENE FOR SYNTHESIS-500GM	500GM	647.40
PB-8207	NAPHTHALENE SCINTILATION GRADE	500GM	717.60
PB-8208	NAPHTHOL GREEN B for Microscopy C. I. No. 10020-100GM	100GM	873.60
PB-8209	NAPHTHOL GREEN B for Microscopy C. I. No. 10020-25GM	25GM	288.60
PB-8210	NAPHTHALENE AR-500GM	500GM	686.40
PB-8211	N-BROMOSUCCINIMIDE-100GM	100GM	522.60
PB-8212	N-BROMOSUCCINIMIDE-500GM	500GM	2,152.80
PB-8213	n-BUTANOL 99% for synthesis ((Butan-1-ol)-)2.5LTR	2.5LTR	1,661.40

CODE	PRODUCT	PACKING	PRICE
PB-8214	n-BUTANOL 99% for synthesis ((Butan-1-ol.)-500ML	500ML	374.40
PB-8215	n-BUTANOL AR 99.5%-2.5LTR	2.5LTR	1,872.00
PB-8216	n-BUTANOL AR 99.5%-500ML	500ML	483.60
PB-8217	n-BUTANOL FOR HPLC & SPECTOSCOPY	1LTR	1,450.80
PB-8218	n-BUTANOL FOR HPLC & SPECTOSCOPY	2.5LTR	3,049.80
PB-8219	n-BUTYL ACETATE AR 99.5%-2.5LTR	2.5LTR	2,979.60
PB-8220	n-BUTYL ACETATE AR 99.5%-500ML	500ML	717.60
PB-8221	n-BUTYL ACETATE LR 99%-2.5LTR	2.5LTR	1,942.20
PB-8222	n-BUTYL ACETATE LR 99%-500ML	500ML	460.20
PB-8223	n-BUTYL METHACRYLATE 99% for Synthesis (Stabilized)	500ML	1,037.40
PB-8224	n-BUTYL METHACRYLATE 99% for Synthesis (Stabilized)	2.5LTR	4,157.40
PB-8225	n-BUTYLAMINE AR	500ML	873.60
PB-8226	n-BUTYLAMINE AR	2.5LTR	3,463.20
PB-8227	n-BUTYLAMINE LR 98%	500ML	733.20
PB-8228	n-BUTYLAMINE LR 98%	2.5LTR	3,049.80
PB-8229	N-BUTYRIC ACID 99% FOR SYNTHESIS	500ML	803.40
PB-8230	N-BUTYRIC ACID 99% FOR SYNTHESIS	2.5LTR	3,190.20
PB-8231	N-CETYL-N,N,N, TRIMETHYL AMMONIUM BROMIDE (CETRIMIDE)-100GM	100GM	530.40
PB-8232	N-CETYL-N,N,N, TRIMETHYL AMMONIUM BROMIDE (CETRIMIDE)-500GM	500GM	1,731.60
PB-8233	N-CETYL-N,N,N, TRIMETHYL AMMONIUM BROMIDE AR (CETRIMIDE)-100GM	100GM	569.40
PB-8234	N-CETYL-N,N,N, TRIMETHYL AMMONIUM BROMIDE AR (CETRIMIDE)-500GM	500GM	2,082.60
PB-8235	N-CHLOROSUCCINIMIDE -100GM	100GM	553.80
PB-8236	N-CHLOROSUCCINIMIDE -250GM	250GM	1,357.20
PB-8237	N-CHLOROSUCCINIMIDE -500GM	500GM	2,535.00
PB-8238	NEISSER'S STAIN A (Methylene Blue)-125ML	125ML	179.40
PB-8239	NEISSER'S STAIN B (Crystal Violet) C.I. No. 42555-125ML	125ML	179.40
PB-8240	NEISSER'S STAIN C (Chrysoidine)-125ML	125ML	179.40
PB-8241	NEOCUPROINE AR-1GM	1GM	1638.00
PB-8242	NEOCUPROINE AR-5GM	5GM	8268.00
PB-8243	NEOCUPROINE HYDROCHLORIDE AR-1GM	1GM	2262.00
PB-8244	NEOCUPROINE HYDROCHLORIDE AR-5GM	5GM	12012.00
PB-8245	NEODYMIUM OXIDE AR-10GM	10GM	1,341.60
PB-8246	NEODYMIUM OXIDE AR-25GM	25GM	2,839.20
PB-8247	NESSLER'S REAGENT (For ammonia & ammonium salt)-100ML	100ML	358.80
PB-8248	NESSLER'S REAGENT (For ammonia & ammonium salt)-250ML	250ML	741.00
PB-8249	NESSLER'S REAGENT (KING'S) (For determination of serum urea nitrogen)-100ML	100ML	390.00
PB-8250	NEUTRAL RED INDICATOR AR-100GM	100GM	3588.00
PB-8251	NEUTRAL RED INDICATOR AR-10GM	10GM	655.20
PB-8252	NEUTRAL RED INDICATOR AR-25GM	25GM	1279.20
PB-8253	NEUTRAL RED INDICATOR SOLUTION-125ML	125ML	148.20
PB-8254	NEW FUCHSIN-100GM	100GM	967.20
PB-8255	NEW FUCHSIN-25GM	25GM	312.00
PB-8256	NEWMAN'S STAIN(MODIFIED)	100ML	140.40
PB-8257	n-HEPTANE 99%-2.5LTR	2.5LTR	4,508.40
PB-8258	n-HEPTANE 99%-500ML	500ML	1,076.40
PB-8259	n-HEPTANE AR 99.5%-2.5LTR	2.5LTR	5,194.80
PB-8260	n-HEPTANE AR 99.5%-500ML	500ML	1,216.80
PB-8261	n-HEPTANOL AR	500ML	1,669.20
PB-8262	n-HEPTANOL AR	2.5LTR	8,041.80
PB-8263	n-HEPTANOL FOR SYNTHESIS (1-Heptanol, Heptyl Alcohol)	500ML	1,450.80
PB-8264	n-HEPTANOL FOR SYNTHESIS (1-Heptanol, Heptyl Alcohol)	2.5LTR	6,793.80
PB-8265	n-HEXANE 95% FOR SYNTHESIS-2.5LTR	2.5LTR	3385.20
PB-8266	n-HEXANE 95% FOR SYNTHESIS-500ML	500ML	873.60
PB-8267	n-HEXANE 99% AR-2.5LTR	2.5LTR	4524.00
PB-8268	n-HEXANE 99% AR-500ML	500ML	936.00
PB-8269	n-HEXANE 99% FOR SYNTHESIS -2.5LTR	2.5LTR	4368.00

CODE	PRODUCT	PACKING	PRICE
PB-8270	n-HEXANE 99% FOR SYNTHESIS -500ML	500ML	897.00
PB-8271	n-HEXANE FOR HPLC 95%-1LTR	1LTR	1,996.80
PB-8272	n-HEXANE FOR HPLC 95%-2.5LTR	2.5LTR	4,422.60
PB-8273	n-HEXANE FOR HPLC 99%-1LTR	1LTR	2,496.00
PB-8274	n-HEXANE FOR HPLC 99%-2.5LTR	2.5LTR	5,826.60
PB-8275	N-HEXANOIC ACID (CAPROIC ACID)-2.5LTR	2.5LTR	5382.00
PB-8276	N-HEXANOIC ACID (CAPROIC ACID)-250ML	250ML	639.60
PB-8277	N-HEXANOIC ACID (CAPROIC ACID)-500ML	500ML	1170.00
PB-8278	n-HEXANOL AR 99%	500ML	1,911.00
PB-8279	n-HEXANOL AR 99%	2.5LTR	8,455.20
PB-8280	n-HEXANOL LR 98%	500ML	1,731.60
PB-8281	n-HEXANOL LR 98%	2.5LTR	7,488.00
PB-8282	N-HYDROXYSUCCINIMIDE-100GM	100GM	3588.00
PB-8283	N-HYDROXYSUCCINIMIDE-25GM	25GM	1170.00
PB-8284	N-HYDROXYSUCCINIMIDE-500GM	500GM	12948.00
PB-8285	NICKEL (POWDER) 200 MESH-100GM	100GM	1684.80
PB-8286	NICKEL (POWDER) 200 MESH-500GM	500GM	7878.00
PB-8287	NICKEL ACETATE LR (TETRAHYDRATE)-250GM	250GM	1,661.40
PB-8288	NICKEL ACETATE LR (TETRAHYDRATE)-500GM	500GM	3,049.80
PB-8289	NICKEL ALUMINIUM ALLOY POWDER-500GM	500GM	3697.20
PB-8290	NICKEL CARBONATE-500GM	500GM	3432.00
PB-8291	NICKEL CHLORIDE LR-500GM	500GM	2,074.80
PB-8292	NICKEL CHLORIDE LR-500GM	5KG	19,133.40
PB-8293	NICKEL NITRATE AR HEXAHYDRATE-250GM	250GM	1,201.20
PB-8294	NICKEL NITRATE AR HEXAHYDRATE-500GM	500GM	2,277.60
PB-8295	NICKEL NITRATE LR HEXAHYDRATE-500GM	500GM	1,731.60
PB-8296	NICKEL OXIDE BLACK LR-250GM	250GM	4524.00
PB-8297	NICKEL OXIDE BLACK LR-500GM	500GM	9672.00
PB-8298	NICKEL SULPHAMATE SOLUTION 110GM Nickel per Ltr-2.5KG	2.5KG	5686.20
PB-8299	NICKEL SULPHAMATE SOLUTION 110GM Nickel per Ltr-500GM	500GM	1263.60
PB-8300	NICKEL SULPHATE AR (HEXAHYDRATE)-500GM	500GM	3814.20
PB-8301	NICKEL SULPHATE LR (HEXAHYDRATE)-500GM	500GM	1731.60
PB-8302	NICKEL SULPHATE LR (HEXAHYDRATE)-5KG	5KG	16918.20
PB-8303	NICOTINIC ACID (NIACIN)-100GM	100GM	546.00
PB-8304	NICOTINIC ACID (NIACIN)-1KG	1KG	3900.00
PB-8305	NICOTINIC ACID (NIACIN)-25GM	25GM	265.20
PB-8306	NIGROSIN STAIN 10% WV-100ML	100ML	148.20
PB-8307	NIGROSINE (ALCOHOL SOLUBLE)-100GM	100GM	858.00
PB-8308	NIGROSINE (ALCOHOL SOLUBLE)-25GM	25GM	296.40
PB-8309	NIGROSINE FOR MICROSCOPY (WATER SOLUBLE)-100GM	100GM	858.00
PB-8310	NIGROSINE FOR MICROSCOPY (WATER SOLUBLE)-25GM	25GM	265.20
PB-8311	NILE BLUE SULPHATE-10GM	10GM	998.40
PB-8312	NILE BLUE SULPHATE-25GM	25GM	1965.60
PB-8313	NINHYDRIN AR-100GM	100GM	5132.40
PB-8314	NINHYDRIN AR-10GM	10GM	787.80
PB-8315	NINHYDRIN AR-25GM	25GM	1731.60
PB-8316	NINHYDRIN SOLUTION FOR TLC SPRAY	125ML	514.80
PB-8317	NIObIUM PENTOXIDE AR-10GM	10GM	873.60
PB-8318	NIObIUM PENTOXIDE AR-25GM	25GM	1942.20
PB-8319	NIObIUM PENTOXIDE AR-500GM	500GM	35357.40
PB-8320	N-IODOSUCCINIMIDE FOR SYNTHESIS-100GM	100GM	8,182.20
PB-8321	N-IODOSUCCINIMIDE FOR SYNTHESIS-25GM	25GM	2,636.40
PB-8322	NITRAZINE YELLOW-25GM	25GM	13517.40
PB-8323	NITRAZINE YELLOW-5GM	5GM	2979.60
PB-8324	NITRIC ACID AR 69-71%-2.5LTR	2.5LTR	1294.80
PB-8325	NITRIC ACID AR 69-71%-500ML	500ML	452.40

CODE	PRODUCT	PACKING	PRICE
PB-8326	NITRIC ACID PURE LR 69-72%-2.5LTR	2.5LTR	1216.80
PB-8327	NITRIC ACID PURE LR 69-72%-500ML	500ML	405.60
PB-8328	NITRILOTRIACETIC ACID AR-100GM	100GM	296.40
PB-8329	NITRILOTRIACETIC ACID AR-500GM	500GM	1131.00
PB-8330	NITRO B.T. AR (NITRO BLUE TETRA ZOLIUM CHLORIDE AR)-1GM	1GM	3712.80
PB-8331	NITRO B.T. AR (NITRO BLUE TETRA ZOLIUM CHLORIDE AR)-250MG	250MG	1622.40
PB-8332	NITROBENZENE AR	500ML	624.00
PB-8333	NITROBENZENE AR	2.5LTR	2558.40
PB-8334	NITROBENZENE FOR SYNTHESIS	500ML	639.60
PB-8335	NITROBENZENE FOR SYNTHESIS	2.5LTR	2574.00
PB487506	4-NITROPHENYL A-D-GLUCOPYRANOSIDE	1GM	9100.00
PB-8336	N-METHYL PIPERZINE 99% FOR SYNTHESIS	100ML	764.40
PB-8337	N-METHYL PIPERZINE 99% FOR SYNTHESIS	500ML	3,533.40
PB-8338	N-METHYL-2-PYROLIDONE LR 98%-2.5LTR	2.5LTR	4,570.80
PB-8339	N-METHYL-2-PYROLIDONE LR 98%-500ML	500ML	998.40
PB-8340	N-METHYL-2-PYROLIDONE AR-2.5LTR	2.5LTR	4,851.60
PB-8341	N-METHYL-2-PYROLIDONE AR-500ML	500ML	1,162.20
PB-8342	N-METHYLANILINE FOR SYNTHESIS 98%	500ML	904.80
PB-8343	N-METHYLANILINE FOR SYNTHESIS 98%	2.5LTR	4,165.20
PB-8344	N-N-DIMETHYLACETAMIDE AR	500ML	694.20
PB-8345	N-N-DIMETHYLACETAMIDE AR	2.5LTR	2,191.80
PB-8346	N-N-DIMETHYLACETAMIDE LR -2.5LTR	2.5LTR	2,074.80
PB-8347	N-N-DIMETHYLACETAMIDE LR-500ML	500ML	530.40
PB-8348	n-OCTANOL 99% FOR SYNTHESIS (OCTAN-1-OL, CAPRYL ALCOHOL)	500ML	1528.80
PB-8349	n-OCTANOL 99% FOR SYNTHESIS (OCTAN-1-OL, CAPRYL ALCOHOL)	2.5LTR	7488.00
PB-8350	N-PENTANE AR-2.5LTR	2.5LTR	4024.80
PB-8351	N-PENTANE AR-500ML	500ML	928.20
PB-8352	N-PENTANE FOR SYNTHESIS-2.5LTR	2.5LIT	3744.00
PB-8353	N-PENTANE FOR SYNTHESIS-500ML	500ML	803.40
PB-8354	N-PHENYLANTHRANILIC ACID AR-100GM	100GM	3666.00
PB-8355	N-PHENYLANTHRANILIC ACID AR-25GM	25GM	1076.40
PB-8356	N-PROPYL ACETATE FOR SYNTHESIS 98%	500ML	663.00
PB-8357	N-PROPYL ACETATE FOR SYNTHESIS 98%	2.5LTR	3120.00
PB-8358	n-PROPYL ALCOHOL(Propan-1-ol) AR-2.5LTR	2.5LTR	2652.00
PB-8359	n-PROPYL ALCOHOL(Propan-1-ol) AR-500ML	500ML	670.80
PB-8360	n-PROPYL ALCOHOL(Propan-1-ol) LR -500ML	500ML	546.00
PB-8361	n-PROPYL ALCOHOL(Propan-1-ol) LR-2.5LTR	2.5LTR	2418.00
PB-8362	n-PROPYLAMINE LR -2.5LTR	2.5LTR	4297.80
PB-8363	n-PROPYLAMINE LR -500ML	500ML	873.60
PB-8364	n-VALERIC ACID 99%-2.5LTR	2.5LTR	7,066.80
PB-8365	n-VALERIC ACID 99%-500ML	500ML	1,942.20
PB-8366	o-CRESOL FOR SYNTHESIS-2.5LTR	2.5 LIT	4,024.80
PB-8367	o-CRESOL FOR SYNTHESIS-500ML	500ML	858.00
PB-8368	o-CRESOLPHTHALEIN (PH INDICATOR)-25GM	25GM	569.40
PB-8369	o-CRESOLPHTHALEIN (PH INDICATOR)-5GM	5GM	218.40
PB-8370	o-CRESOLPHTHALEIN COMPLEXONE-1GM	1GM	967.20
PB-8371	o-CRESOLPHTHALEIN COMPLEXONE-5GM	5GM	3,884.40
PB-8372	OCTYL SULFATE SODIUM SALT FOR HPLC-5GM	5GM	3322.80
PB-8373	o-DIANISIDINE LR	25GM	569.40
PB-8374	o-DIANISIDINE LR	100GM	1,801.80
PB-8375	o-DIANISIDINE LR	250GM	4,165.20
PB-8376	OIL RED O for ELECTROPHORESIS C.I. No 26125	10GM	226.20
PB-8377	OIL RED O for ELECTROPHORESIS C.I. No 26125	25GM	452.40
PB-8378	OLEIC ACID (Suitable for Pharma Industry)-2.5LTR	2.5LTR	2152.80
PB-8379	OLEIC ACID (Suitable for Pharma Industry)-500ML	500ML	569.40
PB-8380	OLIVE OIL -100ML	100ML	663.00

CODE	PRODUCT	PACKING	PRICE
PB-8381	OLIVE OIL-250ML	250ML	1388.40
PB-8382	o-NITROPHENYL b-d GALACTOPYRANOSIDE LR	1GM	1575.60
PB-8383	o-PHENYLENEDIAMINE FOR SYNTHESIS -100GM	100GM	390.00
PB-8384	o-PHENYLENEDIAMINE FOR SYNTHESIS -250GM	250GM	803.40
PB-8385	o-PHTHALALDEHYDE AR-25GM	25GM	5132.40
PB-8386	o-PHTHALALDEHYDE AR-5GM	5GM	1177.80
PB-8387	ORACET BLUE 2R(1-AMINO-4-ANILINOANTHRAQUINONE) C.I. No.61110-5GM	5GM	15600.00
PB-8388	ORANGE G Indicator For microscopy-100GM	100GM	967.20
PB-8389	ORANGE G Indicator For microscopy-25GM	25GM	343.20
PB-8390	ORCEIN FOR MICROSCOPY-10GM	10GM	7332.00
PB-8391	ORCEIN FOR MICROSCOPY-5GM	5GM	3822.00
PB-8392	ORCINOL -100GM	100GM	8736.00
PB-8393	ORCINOL -10GM	10GM	1216.80
PB-8394	ORCINOL -25GM	25GM	2184.00
PB-8395	ORTHOPHOSPHORIC ACID AR-2.5LTR	2.5LTR	3525.60
PB-8396	ORTHOPHOSPHORIC ACID AR-500ML	500ML	733.20
PB-8397	ORTHOPHOSPHORIC ACID AR-5LTR	5LTR	6520.80
PB-8398	ORTHOPHOSPHORIC ACID FOR HPLC-1LTR	1LTR	4165.20
PB-8399	ORTHOPHOSPHORIC ACID LR-2.5LTR	2.5LTR	2979.60
PB-8400	ORTHOPHOSPHORIC ACID LR-500ML	500ML	663.00
PB-8401	ORTHOPHOSPHORIC ACID LR-5LTR	5LTR	5132.40
PB-8402	OSMIC ACID AR-1GM	1GM	12168.00
PB-8403	o-TOLIDINE AR-100GM	100GM	4056.00
PB-8404	o-TOLIDINE AR-25GM	25GM	1014.00
PB-8405	o-TOLIDINE DIHYDROCHLORIDE AR	25GM	928.20
PB-8406	o-TOLIDINE DIHYDROCHLORIDE AR	100GM	3,463.20
PB-8407	o-TOLIDINE LR-100GM	100GM	3744.00
PB-8408	o-TOLIDINE LR-500GM	500GM	7020.00
PB-8409	o-TOLIDINE(REAGENT) FOR CHLORINE ESTIMATION-500ML	500ML	390.00
PB-8410	o-TOLUIC ACID 98% (2-Methylbenzoic acid)-500GM	500GM	1,037.40
PB-8411	OXALIC ACID 0.1 N (N/10)-500ML	500ML	187.20
PB-8412	OXALIC ACID AR-500GM	500GM	436.80
PB-8413	OXALIC ACID PURIFIED-1KG	1KG	663.00
PB-8414	OXALIC ACID PURIFIED-500GM	500GM	390.00
PB-8415	OX-BILE DRIED POWDER FOR MICROBIOLOGY	100GM	943.80
PB-8416	OX-BILE DRIED POWDER FOR MICROBIOLOGY	500GM	3260.40
PB-8417	OX-GALL POWDER BACTERIOLOGICAL GRADE-100GM	100GM	1341.60
PB-8418	OX-GALL POWDER BACTERIOLOGICAL GRADE-500GM	500GM	4781.40
PB-8419	o-XYLENE FOR SYNTHESIS	500ML	444.60
PB-8420	o-XYLENE FOR SYNTHESIS	2.5LTR	1,801.80
PB-8421	PALLADIUM (II) OXIDE HYDRATE-1GM	1GM	13104.00
PB-8422	PALLADIUM ACETATE-1GM	1GM	6084.00
PB-8423	PALLADIUM ACETATE-5GM	5GM	28704.00
PB-8424	PALLADIUM -CHARCOAL ACTIVATED (10%pd)-10GM	10GM	11544.00
PB-8425	PALLADIUM CHLORIDE PURISS-1GM	1GM	8268.00
PB-8426	PALLADIUM CHLORIDE PURISS-5GM	5GM	38532.00
PB-8427	PALLADIUM HYDROXIDE 20% ON CHARCOAL	1GM	3276.00
PB-8428	PALLADIUM HYDROXIDE 20% ON CHARCOAL	5GM	12168.00
PB-8429	PALLADIUM NITRATE (44% PD content)	1GM	9984.00
PB-8430	PALLADIUM SPONGE 99.9% POWDER	250MG	4711.20
PB-8431	PALLADIUM SPONGE 99.9% POWDER	1GM	16364.40
PB-8432	PALLADIUM-CALCIUM CARBONATE(10% pd)-10GM	10GM	11700.00
PB-8433	PALLADIUM-CHARCOAL ACTIVATED (5%pd)-10GM	10GM	6084.00
PB-8434	PALLIDIUM SULPHATE	250 MG	5148.00
PB-8435	PALLIDIUM SULPHATE	1GM	17160.00
PB-8436	PALMITIC ACID	500GM	577.20

CODE	PRODUCT	PACKING	PRICE
PB-8437	PALMITIC ACID AR-100GM	100GM	3260.40
PB-8438	PALMITIC ACID AR-25GM	25GM	1068.60
PB-8439	PAN INDICATOR AR-1GM	1GM	1404.00
PB-8440	PAN INDICATOR AR-5GM	5GM	7722.00
PB-8441	PANCREATIN (ACTIVITY EQ. TO 1NF)-100GM	100GM	826.80
PB-8442	PANCREATIN (ACTIVITY EQ. TO 1NF)-500GM	500GM	3400.80
PB-8443	p-ANISIDINE 98%	250-GM	655.20
PB-8444	p-ANISIDINE 98%-500GM	500GM	1,154.40
PB-8445	PAPANICOLAOUS SOLUTION 1a-125ML	125ML	787.80
PB-8446	PAPANICOLAOUS SOLUTION 2b-125ML	125ML	288.60
PB-8447	PAPANICOLAOUS SOLUTION 3b-125ML	125ML	577.20
PB-8448	PAR INDICATOR AR-1GM	1GM	1014.00
PB-8449	PAR INDICATOR AR-5GM	5GM	4524.00
PB-8450	PARAFFIN LIQUID COLOURLESS LIGHT-2.5LTR	2.5LTR	1450.80
PB-8451	PARAFFIN LIQUID COLOURLESS LIGHT-500ML	500ML	390.00
PB-8452	PARAFFIN LIQUID COLOURLESS,HEAVY-2.5LTR	2.5LTR	1918.80
PB-8453	PARAFFIN LIQUID COLOURLESS,HEAVY-500ML	500ML	530.40
PB-8454	PARAFFIN WAX 56-58C-1KG	1KG	1326.00
PB-8455	PARAFFIN WAX 56-58C-500GM	500GM	702.00
PB-8456	PARAFFIN WAX 58-60C-2KG	2KG	2496.00
PB-8457	PARAFFIN WAX 58-60C-500GM	500GM	748.80
PB-8458	PARAFFIN WAX 60-62C-2KG	2KG	2418.00
PB-8459	PARAFFIN WAX 60-62C-500GM	500GM	733.20
PB-8460	PARAFFIN WAX WITH CERESIN CONGEALING POINT ABOUT 60C-2KG	2KG	2652.00
PB-8461	PARAFFIN WAX WITH CERESIN CONGEALING POINT ABOUT 60C-500GM	500GM	904.80
PB-8462	PARAFFIN WAX-58-60C PELLETS	500GM	647.40
PB-8463	PARAFORMALDEHYDE PURE-500GM	500GM	436.80
PB-8464	PARAROSANILINE (BASE) FOR MICROSCOPY -25GM	25GM	3042.00
PB-8465	PARAROSANILINE CHLORIDE FOR MICROSCOPY-100GM	100GM	7098.00
PB-8466	PARAROSANILINE CHLORIDE FOR MICROSCOPY-25GM	25GM	2277.60
PB-8467	PATENT BLUE V (VF)	10GM	327.60
PB-8468	PATENT BLUE V (VF)	25GM	764.40
PB-8469	PATTON AND REEDER'S REAGENT AR-25GM	25GM	1248.00
PB-8470	PATTON AND REEDER'S REAGENT AR-5GM	5GM	312.00
PB-8471	p-BENZOQUINONE FOR SYNTHESIS-100GM	100GM	1,107.60
PB-8472	p-BENZOQUINONE FOR SYNTHESIS-250GM	250GM	2,355.60
PB-8473	p-COUAMARIC ACID	25GM	4,024.80
PB-8474	p-COUAMARIC ACID	100GM	12,136.80
PB-8475	p-CRESOL FOR SYNTHESIS-2.5LTR	2.5LTR	6,099.60
PB-8476	p-CRESOL FOR SYNTHESIS-500ML	500ML	1,528.80
PB-8477	p-DIMETHYL AMINO BENZYLIDINE RHODANINE AR-25GM	25GM	2,191.80
PB-8478	p-DIMETHYL AMINO BENZYLIDINE RHODANINE AR-5GM	5GM	717.60
PB-8479	p-DIMETHYL AMINO BENZALDEHYDE AR-100GM	100GM	1,263.60
PB-8480	p-DIMETHYL AMINO BENZALDEHYDE AR-1KG	1KG	10,951.20
PB-8481	p-DIMETHYL AMINO BENZALDEHYDE-100GM	100GM	1,123.20
PB-8482	p-DIMETHYL AMINO BENZALDEHYDE-1KG	1KG	10,264.80
PB-8483	p-DIMETHYL AMINO CINNAMALDEHYDE AR -10GM	10GM	6,793.80
PB-8485	p-NITROPHENYLPHOSPHATE DISODIUM SALT HEXAHYDRATE (PNPP) Crystalline extrapure, 99%	25gm	4,291.30
PB-8484	PECTIN PURE-100GM	100GM	1053.00
PB-8485	PECTIN PURE-500GM	500GM	4914.00
PB-8486	PEPPERMINT OIL PURE-100ML	100ML	873.60
PB-8487	PEPPERMINT OIL PURE-500ML	500ML	3814.20
PB-8488	PEPTONE BACTERIOLOGICAL GRANULAR	500GM	1248.00
PB-8489	PEPTONE BACTERIOLOGICAL GRANULAR	5KG	14040.00
PB-8490	PEPTONE BACTERIOLOGICAL-500GM	500GM	1638.00

CODE	PRODUCT	PACKING	PRICE
PB-8491	PEPTONE BACTERIOLOGICAL-5KG	5KG	16380.00
PB-8492	PERCHLORIC ACID 0.1 N IN GLACIAL ACETIC ACID-500ML	500ML	1177.80
PB-8493	PERCHLORIC ACID 20%	500ML	655.20
PB-8494	PERCHLORIC ACID 20%	2.5LTR	3120.00
PB-8495	PERCHLORIC ACID AR 60%-2.5LTR	2.5LTR	7332.00
PB-8496	PERCHLORIC ACID AR 60%-500ML	500ML	1528.80
PB-8497	PERCHLORIC ACID AR 70% (SUITABLE FOR DIAMOND INDUSTRY)-2.5LTR	2.5LTR	8252.40
PB-8498	PERCHLORIC ACID AR 70% (SUITABLE FOR DIAMOND INDUSTRY)-500ML	500ML	1840.80
PB-8499	PERCHLORIC ACID AR 70%-2.5LTR	2.5LTR	7924.80
PB-8500	PERCHLORIC ACID AR 70%-500ML	500ML	1716.00
PB-8501	PERIODIC ACID AR-100GM	100GM	4212.00
PB-8502	PERIODIC ACID AR-25GM	25GM	1435.20
PB-8503	PERIODIC ACID FOR SYNTHESIS-100GM	100GM	3588.00
PB-8504	PERIODIC ACID FOR SYNTHESIS-25GM	25GM	1060.80
PB-8505	PETROLEUM ETHER 100-200 C FOR SYNTHESIS-2.5LTR	2.5LTR	2184.00
PB-8506	PETROLEUM ETHER 100-200 C FOR SYNTHESIS-500ML	500ML	561.60
PB-8507	PETROLEUM ETHER 40-60C AR-2.5LTR	2.5LTR	2776.80
PB-8508	PETROLEUM ETHER 40-60C AR-500ML	500ML	678.60
PB-8509	PETROLEUM ETHER 40-60C LR-2.5LTR	2.5LTR	2355.60
PB-8510	PETROLEUM ETHER 40-60C LR-500ML	500ML	624.00
PB-8511	PETROLEUM ETHER 60-80C AR-2.5LTR	2.5LTR	1482.00
PB-8512	PETROLEUM ETHER 60-80C AR-500ML	500ML	452.40
PB-8513	PETROLEUM ETHER 60-80C LR -2.5LTR	2.5LTR	1396.20
PB-8514	PETROLEUM ETHER 60-80C LR -500ML	500ML	390.00
PB-8515	PETROLEUM JELLY WHITE-500GM	500GM	429.00
PB-8516	PHENAZINE METHOLSULPHATE-1GM	1GM	998.40
PB-8517	PHENAZINE METHOLSULPHATE-5GM	5GM	3463.20
PB-8518	PHENOL AR-500GM	500GM	702.00
PB-8519	PHENOL CRYSTAL LR-500GM	500GM	624.00
PB-8520	PHENOL RED AR (pH indicator)-100GM	100GM	2262.00
PB-8521	PHENOL RED AR (pH indicator)-25GM	25GM	655.20
PB-8522	PHENOL RED AR (pH indicator)-5GM	5GM	202.80
PB-8523	PHENOL RED INDICATOR SOLUTION-125ML	125ML	156.00
PB-8524	PHENOLDISULPHONIC ACID SOLUTION 25%-500ML	500ML	1528.80
PB-8525	PHENOLPHTHALEIN (INDICATOR) SOLUTION (1%)-125ML	125ML	163.80
PB-8526	PHENOLPHTHALEIN (INDICATOR) SOLUTION (1%)-500ML	500ML	530.40
PB-8527	PHENOLPHTHALEIN INDICATOR-100GM	100GM	748.80
PB-8528	PHENOLPHTHALEIN INDICATOR-500GM	500GM	3120.00
PB-8529	PHENOLPHTHALEIN INDICATOR-50GM	50GM	421.20
PB-8530	PHENYL CHLOROFORMATE FOR SYNTHESIS	500ML	2074.80
PB-8531	PHENYL CHLOROFORMATE FOR SYNTHESIS	2.5LTR	9562.80
PB-8532	PHENYL HYDRAZINE AR	100ML	1716.00
PB-8533	PHENYL HYDRAZINE AR	500ML	7644.00
PB-8534	PHENYL HYDRAZINE FOR SYNTHESIS	250ML	1326.00
PB-8535	PHENYL HYDRAZINE FOR SYNTHESIS	500ML	2496.00
PB-8536	PHENYL HYDRAZINE FOR SYNTHESIS	2.5LTR	12324.00
PB-8537	PHENYL HYDRAZINE HYDROCHLORIDE -100GM	100GM	803.40
PB-8538	PHENYL HYDRAZINE HYDROCHLORIDE -250GM	250GM	1872.00
PB-8539	PHENYL HYDRAZINE HYDROCHLORIDE AR-100GM	100GM	998.40
PB-8540	PHENYL HYDRAZINE HYDROCHLORIDE AR-250GM	250GM	2028.00
PB-8541	PHENYL MERCURY ACETATE FOR SYNTHESIS-100GM	100GM	16364.40
PB-8542	PHENYL MERCURY ACETATE FOR SYNTHESIS-25GM	25GM	4297.80
PB-8543	PHENYL MERCURY NITRATE (BASIC) FOR SYNTHESIS -100GM	100GM	43680.00
PB-8544	PHENYL MERCURY NITRATE (BASIC) FOR SYNTHESIS -25GM	25GM	12324.00
PB-8545	PHENYL PHOSPHATE DISODIUM SALT AR-100GM	100GM	11700.00
PB-8546	PHENYL PHOSPHATE DISODIUM SALT AR-25GM	25GM	3588.00

CODE	PRODUCT	PACKING	PRICE
PB-8547	PHENYL TRIMETHYL AMMONIUM CHLORIDE-100GM	100GM	670.80
PB-8548	PHENYL TRIMETHYL AMMONIUM CHLORIDE-500GM	500GM	2808.00
PB-8549	PHLOROGLUCINOL AR-100GM	100GM	5928.00
PB-8550	PHLOROGLUCINOL AR-25GM	25GM	1544.40
PB-8551	PHLOXIN B FOR MICROSCOPY-100GM	100GM	2028.00
PB-8552	PHLOXIN B FOR MICROSCOPY-25GM	25GM	592.80
PB-8553	PHOSPHOMOLYBDIC ACID AR-100GM	100GM	3884.40
PB-8554	PHOSPHOMOLYBDIC ACID AR-25GM	25GM	1279.20
PB-8555	PHOSPHORUS OXYCHLORIDE LR-2.5LTR	2.5LTR	3744.00
PB-8556	PHOSPHORUS OXYCHLORIDE LR-500ML	500ML	873.60
PB-8557	PHOSPHORUS PENTAOXIDE FOR SYNTHESIS-500GM	500GM	1151.28
PB-8558	PHOSPHORUS PENTOXIDE AR-500GM	500GM	1372.80
PB-8559	PHOSPHORUS TRICHLORIDE FOR SYNTHESIS -2.5LTR	2.5LTR	3822.00
PB-8560	PHOSPHORUS TRICHLORIDE FOR SYNTHESIS -500ML	500ML	1045.20
PB-8561	PHOSPHOTUNGSTIC ACID AR-100GM	100GM	3120.00
PB-8562	PHOSPHOTUNGSTIC ACID AR-25GM	25GM	1092.00
PB-8563	PHOSPHOTUNGSTIC ACID LR-100GM	100GM	2808.00
PB-8564	PHOSPHOTUNGSTIC ACID LR-500GM	500GM	12480.00
PB-8565	PHTHALAMIDE FOR SYNTHESIS-500GM	500GM	787.80
PB-8566	PHTHALIC ACID AR-500GM	500GM	764.40
PB-8567	PHTHALIC ACID FOR SYNTHESIS -500GM	500GM	624.00
PB-8568	PHTHALIC ANHYDRIDE FOR SYNTHESIS-500GM	500GM	553.80
PB-8569	PHTHALIC ANHYDRIDE FOR SYNTHESIS-5KG	5KG	4711.20
PB-8570	PHTHALIDE FOR SYNTHESIS-100GM	100GM	842.40
PB-8571	PHTHALIDE FOR SYNTHESIS-500GM	500GM	3400.80
PB-8572	PHTHALIMIDE FOR SYNTHESIS -500GM	500GM	717.60
PB-8573	p-HYDROXY ACETOPHENONE FOR SYNTHESIS-100GM	100GM	624.00
PB-8574	p-HYDROXY ACETOPHENONE FOR SYNTHESIS-500GM	500GM	2,542.80
PB-8575	p-HYDROXYBENZOIC ACID-100GM	100GM	319.80
PB-8576	p-HYDROXYBENZOIC ACID-500GM	500GM	1,177.80
PB-8577	PICRIC ACID AR-100GM	100GM	499.20
PB-8578	PICRIC ACID AR-500GM	500GM	1638.00
PB-8579	PICRIC ACID LR-500GM	500GM	1310.40
PB-8580	PICRIC ACID SOLUTION AR 1.2%-100ML	100ML	195.00
PB-8581	PICRIC ACID SOLUTION AR 1.2%-500ML	500ML	795.60
PB-8582	PIPERAZINE (Anhydrous) 98%-1KG	1KG	3190.20
PB-8583	PIPERAZINE (Anhydrous) 98%-250GM	250GM	904.80
PB-8584	PIPERIDINE AR 99%-100ML	100ML	795.60
PB-8585	PIPERIDINE AR 99%-500ML	500ML	2909.40
PB-8586	PIPERIDINE FOR SYNTHESIS 98%-1LTR	1LTR	4024.80
PB-8587	PIPERIDINE FOR SYNTHESIS 98%-2.5LTR	2.5LTR	8182.20
PB-8588	PIPERIDINE FOR SYNTHESIS 98%-500ML	500ML	2425.80
PB-8589	PIPES (BUFFER) {piperazine -N,N-Bis-2-Ethene Sulfonic acid}-100GM	100GM	6793.80
PB-8590	PIPES (BUFFER) {piperazine -N,N-Bis-2-Ethene Sulfonic acid}-25GM	25GM	2425.80
PB-8591	PIPES (BUFFER) {piperazine -N,N-Bis-2-Ethene Sulfonic acid}-5GM	5GM	663.00
PB-8592	PLATINIUM OXIDE(Pt 80%)-1GM	1GM	17752.80
PB-8593	PLATINIUM CHLORIDE (Pt 40%)-1GM	1GM	15756.00
PB-8594	P-NITROPHENOL INDICATOR AR	25GM	436.80
PB-8595	P-NITROPHENOL INDICATOR AR	100GM	1216.80
PB-8596	P-NITROPHENOL INDICATOR AR	500GM	4992.00
PB-8597	POLYETHYLENE GLYCOL 200-2.5LTR	2.5LTR	2964.00
PB-8598	POLYETHYLENE GLYCOL 200-500ML	500ML	639.60
PB-8599	POLYETHYLENE GLYCOL 300	500ML	811.20
PB-8600	POLYETHYLENE GLYCOL 300	2.5LTR	3432.00
PB-8601	POLYETHYLENE GLYCOL 4000-500GM	500GM	702.00
PB-8602	POLYETHYLENE GLYCOL 4000-5KG	5KG	6084.00

CODE	PRODUCT	PACKING	PRICE
PB-8603	POLYETHYLENE GLYCOL 400-2.5LTR	2.5LTR	2808.00
PB-8604	POLYETHYLENE GLYCOL 400-500ML	500ML	639.60
PB-8605	POLYETHYLENE GLYCOL 600	500ML	764.40
PB-8606	POLYETHYLENE GLYCOL 600	2.5LTR	3276.00
PB-8607	POLYETHYLENE GLYCOL 6000-500GM	500GM	717.60
PB-8608	POLYETHYLENE GLYCOL 6000-5KG	5KG	6396.00
PB-8609	POLYPHOSPHORIC ACID FOR SYNTHESIS	500GM	1123.20
PB-8610	POLYPHOSPHORIC ACID FOR SYNTHESIS	2.5KG	4836.00
PB-8611	POLYVINYL ALCOHOL-500GM	500GM	842.40
PB-8612	POLYVINYL ALCOHOL-5KG	5KG	8346.00
PB-8613	POLYVINYL PYRROLIDONE (PVP)-100GM	100GM	702.00
PB-8614	POLYVINYL PYRROLIDONE (PVP)-500GM	500GM	3432.00
PB-8615	PONCEAU S FOR ELECTROPHORESIS-100GM	100GM	2964.00
PB-8616	PONCEAU S FOR ELECTROPHORESIS-25GM	25GM	904.80
PB-8617	POPOP Scintillation Grade (1,4-bis(5-phenyloxaza-2yl)benzene	5 GM	5148.00
PB-8618	POPOP Scintillation Grade (1,4-bis(5-phenyloxaza-2yl)benzene	25GM	21840.00
PB-8619	POPOP Scintillation Grade (1,4-bis(5-phenyloxaza-2yl)benzene	100GM	87360.00
PB-8620	POPSO BUFFER FOR BIOCHEMISTRY-100GM	100GM	17784.00
PB-8621	POPSO BUFFER FOR BIOCHEMISTRY-50GM	50GM	9828.00
PB-8622	POTASium (METAL) FOR SYNTHESIS-100GM	100GM	9360.00
PB-8623	POTASium (METAL) FOR SYNTHESIS-25GM	25GM	2964.00
PB-8624	POTASSIUM PYROANTIMONATE AR-100GM	100GM	2449.20
PB-8625	POTASSIUM PYROANTIMONATE AR-500GM	500GM	11715.60
PB-8626	POTASSIUM ACETATE AR-500GM	500GM	787.80
PB-8627	POTASSIUM ACETATE LR-500GM	500GM	663.00
PB-8628	POTASSIUM BICARBONATE LR-1KG	1KG	1029.60
PB-8629	POTASSIUM BICARBONATE LR-500GM	500GM	538.20
PB-8630	POTASSIUM BROMATE AR-500GM	500GM	1419.60
PB-8631	POTASSIUM BROMATE LR-500GM	500GM	1310.40
PB-8632	POTASSIUM BROMIDE AR-500GM	500GM	1138.80
PB-8633	POTASSIUM BROMIDE FOR IR SPECTROSCOPY-100GM	100GM	7020.00
PB-8634	POTASSIUM BROMIDE LR-500GM	500GM	967.20
PB-8635	POTASSIUM CARBONATE ANHYDROUS AR-500GM	500GM	569.40
PB-8636	POTASSIUM CARBONATE ANHYDROUS-500GM	500GM	452.40
PB-8637	POTASSIUM CARBONATE ANHYDROUS-5KG	5KG	4087.20
PB-8638	POTASSIUM CHLORIDE AR-500GM	500GM	436.80
PB-8639	POTASSIUM CHLORIDE-500GM	500GM	296.40
PB-8640	POTASSIUM CHLORIDE-5KG	5KG	2106.00
PB-8641	POTASSIUM CHLOROPLATINATE -1GM	1GM	11388.00
PB-8642	POTASSIUM CHROMATE AR-500GM	500GM	1513.20
PB-8643	POTASSIUM CHROMATE-500GM	500GM	1404.00
PB-8644	POTASSIUM CITRATE LR (Tripotassium citrate)-500GM	500GM	624.00
PB-8645	POTASSIUM DICHROMATE AR-500GM	500GM	1404.00
PB-8646	POTASSIUM DICHROMATE LR-2.5KG	2.5KG	5538.00
PB-8647	POTASSIUM DICHROMATE LR-500GM	500GM	1232.40
PB-8648	POTASSIUM DIHYDROGEN ORTHOPHOSPHATE ANHYDROUS-500GM	500GM	639.60
PB-8649	POTASSIUM DIHYDROGEN ORTHOPHOSPHATE AR-500GM	500GM	748.80
PB-8650	POTASSIUM FERRICYANIDE AR-500GM	500GM	2340.00
PB-8651	POTASSIUM FERRICYANIDE-100GM	100GM	530.40
PB-8652	POTASSIUM FERRICYANIDE-500GM	500GM	2184.00
PB-8653	POTASSIUM FERROCYANIDE AR-500GM	500GM	1263.60
PB-8654	POTASSIUM FERROCYANIDE-500GM	500GM	1092.00
PB-8655	POTASSIUM FLUORIDE ANHYDROUS-500GM	500GM	1248.00
PB-8656	POTASSIUM FLUORIDE AR ANHYDROUS-500GM	500GM	1872.00
PB-8657	POTASSIUM FORMATE AR	500GM	1872.00
PB-8658	POTASSIUM FORMATE LR 99%	100GM	405.60

CODE	PRODUCT	PACKING	PRICE
PB-8659	POTASSIUM FORMATE LR 99%	500GM	1138.80
PB-8660	POTASSIUM HYDROGEN (+) TARTRATE LR-500GM	500GM	1450.80
PB-8661	POTASSIUM HYDROGEN PHTHALATE LR-500GM	500GM	678.60
PB-8662	POTASSIUM HYDROGEN PHTHALATE AR-500GM	500GM	826.80
PB-8663	POTASSIUM HYDROGEN SULPHATE AR-500GM	500GM	1123.20
PB-8664	POTASSIUM HYDROGEN SULPHATE LR-500GM	500GM	592.80
PB-8665	POTASSIUM HYDROXIDE FLAKES LR-500GM	500GM	429.00
PB-8666	POTASSIUM HYDROXIDE FLAKES LR-5KG	5KG	3229.20
PB-8667	POTASSIUM HYDROXIDE PELLETS AR-500GM	500GM	686.40
PB-8668	POTASSIUM HYDROXIDE PELLETS AR-5KG	5KG	5304.00
PB-8669	POTASSIUM HYDROXIDE PELLETS LR-500GM	500GM	561.60
PB-8670	POTASSIUM HYDROXIDE PELLETS LR-5KG	5KG	4368.00
PB-8671	POTASSIUM IODATE AR-100GM	100GM	1661.40
PB-8672	POTASSIUM IODATE AR-250GM	250GM	3884.40
PB-8673	POTASSIUM IODATE-100GM	100GM	1497.60
PB-8674	POTASSIUM IODATE-250GM	250GM	3322.80
PB-8675	POTASSIUM IODIDE (CONFIRMING TO IP)	25GM	592.80
PB-8676	POTASSIUM IODIDE (CONFIRMING TO IP)	100GM	1638.00
PB-8677	POTASSIUM IODIDE (CONFIRMING TO IP)	500GM	7176.00
PB-8678	POTASSIUM IODIDE (CONFIRMING TO IP)	5KG	70200.00
PB-8679	POTASSIUM IODIDE (CONFIRMING TO IP)-250GM	250GM	3588.00
PB-8680	POTASSIUM IODIDE AR-100GM	100GM	1950.00
PB-8681	POTASSIUM IODIDE AR-250GM	250GM	3978.00
PB-8682	POTASSIUM IODIDE AR-500GM	500GM	7722.00
PB-8683	POTASSIUM METABISULPHITE AR-500GM	500GM	967.20
PB-8684	POTASSIUM METABISULPHITE-500GM	500GM	639.60
PB-8685	POTASSIUM METABISULPHITE-5KG	5KG	5928.00
PB-8686	POTASSIUM METAPERIODATE AR-100GM	100GM	2106.00
PB-8687	POTASSIUM METAPERIODATE AR-500GM	500GM	9048.00
PB-8688	POTASSIUM METAPERIODATE LR-100GM	100GM	1950.00
PB-8689	POTASSIUM METAPERIODATE LR-500GM	500GM	8892.00
PB-8690	POTASSIUM METAVANDATE LR 98%	100GM	2012.40
PB-8691	POTASSIUM METAVANDATE LR 98%	500GM	8182.20
PB-8692	POTASSIUM NITRATE AR-500GM	500GM	553.80
PB-8693	POTASSIUM NITRATE PURIFIED-500GM	500GM	413.40
PB-8694	POTASSIUM NITRATE PURIFIED-5KG	5KG	3814.20
PB-8695	POTASSIUM NITRITE PURIFIED-500GM	500GM	1942.20
PB-8696	POTASSIUM OXALATE AR-500GM	500GM	717.60
PB-8697	POTASSIUM OXALATE LR-500GM	500GM	655.20
PB-8698	POTASSIUM PERMANGANATE -500GM	500GM	1014.00
PB-8699	POTASSIUM PERMANGANATE AR-500GM	500GM	1076.40
PB-8700	POTASSIUM PERSULPHATE AR-500GM	500GM	967.20
PB-8701	POTASSIUM PERSULPHATE LR-500GM	500GM	795.60
PB-8702	POTASSIUM PHOSPHATE DIBASIC ANHYDROUS AR -500GM	500GM	928.20
PB-8703	POTASSIUM PHOSPHATE DIBASIC ANHYDROUS LR-500GM	500GM	780.00
PB-8704	POTASSIUM PYROANTIMONATE-100GM	100GM	1903.20
PB-8705	POTASSIUM PYROANTIMONATE-500GM	500GM	8938.80
PB-8706	POTASSIUM SILICOFLUORIDE 98%-1KG	1KG	702.00
PB-8707	POTASSIUM SODIUM (+) TARTRATE AR-500GM	500GM	1279.20
PB-8708	POTASSIUM SODIUM (+) TARTRATE-500GM	500GM	1076.40
PB-8709	POTASSIUM SODIUM (+) TARTRATE-5KG	5KG	10124.40
PB-8710	POTASSIUM SORBATE-10KG	10KG	27729.00
PB-8711	POTASSIUM SORBATE-1KG	1KG	2340.00
PB-8712	POTASSIUM SULPHATE AR-500GM	500GM	546.00
PB-8713	POTASSIUM SULPHATE LR-500GM	500GM	452.40
PB-8714	POTASSIUM TELLURITE FOR MICROBIOLOGY-100GM	100GM	14352.00

CODE	PRODUCT	PACKING	PRICE
PB-8715	POTASSIUM TELLURITE FOR MICROBIOLOGY-25GM	25GM	3978.00
PB-8716	POTASSIUM THIOCYANATE AR -500GM	500GM	1419.60
PB-8717	POTASSIUM THIOCYANATE LR -500GM	500GM	1310.40
PB-8718	POTASSIUM TITANIUM OXALATE AR 98.5%-100GM	100GM	2012.40
PB-8719	POTASSIUM TITANIUM OXALATE AR 98.5%-500GM	500GM	8041.80
PBN3877	POTASSIUM 4-NITROPHENYL SULFATE	500MG	4136.60
PB-8720	p-PHENYLENEDIAMINE-100GM	100GM	624.00
PB-8721	p-PHENYLENEDIAMINE-250GM	250GM	1076.40
PB-8722	PPO SCINTILLATION GRADE 99%	25GM	2808.00
PB-8723	PPO SCINTILLATION GRADE 99%	100GM	10296.00
PB-8724	PPO SCINTILLATION GRADE 99%	500GM	46800.00
PB-8725	PROPIDIUM IODIDE-25MG	25MG	4227.60
PB-8726	PROPIONIC ACID LR-2.5LTR	2.5LTR	2355.60
PB-8727	PROPIONIC ACID LR-500ML	500ML	553.80
PB-8728	PROIOPHENONE FOR SYNTHESIS -2.5LTR	2.5LTR	6037.20
PB-8729	PROIOPHENONE FOR SYNTHESIS-500ML	500ML	1279.20
PB-8730	PROPYL GALLATE (Anti-Oxidant)-100GM	100GM	1388.40
PB-8731	PROPYL GALLATE (Anti-Oxidant)-500GM	500GM	6084.00
PB-8732	PROPYL-4-HYDROXYBENZOATE LR-500GM	500GM	1716.00
PB-8733	PROPYL-4-HYDROXYBENZOATE LR-5KG	5KG	15444.00
PB-8734	PROPYL-4-HYDROXYBENZOATE SODIUM SALT PURIFIED-500GM	500GM	2028.00
PB-8735	PROPYL-4-HYDROXYBENZOATE SODIUM SALT PURIFIED-5KG	5KG	20124.00
PB-8736	PROPYLENE CARBONATE 99% FOR SYNTHESIS	500ML	1037.40
PB-8737	PROPYLENE CARBONATE 99% FOR SYNTHESIS	2.5LTR	4024.80
PB-8738	PROPYLENE GLYCOL AR-2.5LTR	2.5LIT	2776.80
PB-8739	PROPYLENE GLYCOL AR-500ML	500ML	702.00
PB-8740	PROPYLENE GLYCOL LR-2.5LTR	2.5LIT	2496.00
PB-8741	PROPYLENE GLYCOL LR-500ML	500ML	624.00
PB-8742	PROPYLENE GLYCOL MONOMETHYL ETHER LR 98%	1LTR	1107.60
PB-8743	PROPYLENE GLYCOL MONOMETHYL ETHER LR 98%	2.5LTR	2566.20
PB-8744	p-ROSANILINE HYDROCHLORIDE C.I. NO.42500 -100GM	100GM	5818.80
PB-8745	p-ROSANILINE HYDROCHLORIDE C.I. NO.42500 -25GM	25GM	1942.20
PB-8746	p-ROSOLIC ACID FOR MICROSCOPY-100GM	100GM	5616.00
PB-8747	p-ROSOLIC ACID FOR MICROSCOPY-25GM	25GM	1872.00
PB-8748	p-TOLUENE SULFONIC ACID FOR SYNTHESIS-500GM	500GM	608.40
PB-8749	p-TOLUENE SULFONIC ACID FOR SYNTHESIS-5KG	5KG	4,992.00
PB-8750	p-TOLUIC ACID 99% (4-Methylbenzoic acid)-500GM	500GM	1,177.80
PB-8751	p-TOLUIDINE AR-100GM	100GM	1,248.00
PB-8752	P-TOLUIDINE FOR SYNTHESIS 99%	500GM	873.60
PB-8753	p-TOLUIDINE HYDROCHLORIDE FOR SYNTHESIS-100GM	100GM	1,341.60
PB-8754	p-TOLUIDINE HYDROCHLORIDE FOR SYNTHESIS-250GM	250GM	2,730.00
PB-8755	PYRIDINE AR-2.5LTR	2.5LTR	5545.80
PB-8756	PYRIDINE AR-500ML	500ML	1138.80
PB-8757	PYRIDINE LR-2.5LTR	2.5LTR	4851.60
PB-8758	PYRIDINE LR-500ML	500ML	998.40
PB-8759	PYRIDOXINE HYDROCHLORIDE FOR BIOCHEMISTRY-100GM	100GM	2636.40
PB-8760	PYRIDOXINE HYDROCHLORIDE FOR BIOCHEMISTRY-10GM	10GM	390.00
PB-8761	PYRIDOXINE HYDROCHLORIDE FOR BIOCHEMISTRY-25GM	25GM	803.40
PB-8762	PYROCATECHOL AR-100GM	100GM	1318.20
PB-8763	PYROCATECHOL AR-500GM	500GM	5959.20
PB-8764	PYROCATECHOL VIOLET AR (Catechol Violet)	1GM	1341.60
PB-8765	PYROCATECHOL VIOLET AR (Catechol Violet)	5GM	5413.20
PB-8766	PYROCATECHOL-500GM	500GM	1177.80
PB-8767	PYROGALLOL AR-100GM	100GM	2566.20
PB-8768	PYROGALLOL AR-500GM	500GM	12269.40
PB-8769	PYROGALLOL FOR SYNTHESIS-100GM	100GM	2355.60

CODE	PRODUCT	PACKING	PRICE
PB-8770	PYROGALLOL FOR SYNTHESIS-500GM	500GM	10888.80
PB-8771	PYROGALLOL RED AR-1GM	1GM	1123.20
PB-8772	PYRONIN B C.I. No. 45010-5GM	5GM	2215.20
PB-8773	PYRONIN G C.I. No. 45005-5GM	5GM	2355.60
PB-8774	QUARTZ AR (FINE GRANULAR)-1KG	1KG	3283.80
PB-8775	QUARTZ AR (FINE GRANULAR)-250GM	250GM	943.80
PB-8776	QUINALDINE FOR SYNTHESIS (2-Methylquinoline)	100ML	1872.00
PB-8777	QUINALDINE FOR SYNTHESIS (2-Methylquinoline)	500ML	8736.00
PB-8778	QUINALDINE RED INDICATOR-1GM	1GM	1840.80
PB-8779	QUINALDINE RED INDICATOR-5GM	5GM	7168.20
PB-8780	QUINHYDRONE AR-100GM	100GM	1661.40
PB-8781	QUINHYDRONE AR-500GM	500GM	8182.20
PB-8782	QUININE SULPHATE AR-25GM	25GM	2074.80
PB-8783	QUINOLINE FOR SYNTHESIS	500ML	2496.00
PB-8784	QUINOLINE FOR SYNTHESIS	2.5LTR	11544.00
PB-8785	QUINOLINE YELLOW FOR MICROSCOPY C.I. NO 47000	25GM	1716.00
PB-8786	QUININE SULPHATE (DIHYDRATE)-25GM	25GM	1622.40
PB-8787	R(-) MANDELIC ACID 99%	100GM	3,322.80
PB-8788	RESAZURIN AR-1GM	1GM	1661.40
PB-8789	RESAZURIN AR-5GM	5GM	7768.80
PB-8790	RESERPINE PURISS-1GM	1GM	5460.00
PB-8791	RESERPINE PURISS-5GM	5GM	23400.00
PB-8792	RESORCINOL AR-100GM	100GM	592.80
PB-8793	RESORCINOL AR-500GM	500GM	2730.00
PB-8794	RESORCINOL LR-250GM	250GM	1216.80
PB-8795	RESORCINOL LR-500GM	500GM	1950.00
PB-8796	RHODAMINE 6G C.I. No. 45160-25GM	25GM	1450.80
PB-8797	RHODAMINE 6G C.I. No. 45160	100GM	3697.20
PB-8798	RHODAMINE B AR FOR MICROSCOPY-100GM	100GM	1404.00
PB-8799	RHODAMINE B AR FOR MICROSCOPY-25GM	25GM	436.80
PB-8800	RHODIUM TRICHLORIDE('Rh' 40%) FOR SYNTHESIS-1GM	1GM	16364.40
PB-8801	RIBOFLAVIN FOR BIOCHEMISTRY-10GM	10GM	444.60
PB-8802	RIBOFLAVIN FOR BIOCHEMISTRY-25GM	25GM	928.20
PB-8803	RIBONEUCLEIC ACID (WHITE SPECIAL POWDER) AR -10GM	10GM	4680.00
PB-8804	RIBONEUCLEIC ACID (WHITE SPECIAL POWDER) AR -25GM	25GM	10296.00
PB-8805	RIBONEUCLEIC ACID-25GM	25GM	2698.80
PB-8806	ROSE BENGAL AR-100GM	100GM	6240.00
PB-8807	ROSE BENGAL AR-25GM	25GM	1950.00
PB-8808	RUTHENIUM RED FOR MICROSCOPY-1GM	1GM	4056.00
PB-8809	RUTHENIUM RED FOR MICROSCOPY-5GM	5GM	20124.00
PB-8810	RUTHENIUM TRICHLORIDE PURISS-10GM	10GM	23400.00
PB-8811	RUTHENIUM TRICHLORIDE PURISS-1GM	1GM	2652.00
PB-8812	S(+) MANDELIC ACID 99%	100GM	3,322.80
PB-8813	SACCHARIN INSOLUBLE 99%-500GM	500GM	3822.00
PB-8814	SACCHARIN SODIUM 98%-500GM	500GM	3666.00
PB-8815	SAFRANINE FOR MICROSCOPY -100GM	100GM	2808.00
PB-8816	SAFRANINE FOR MICROSCOPY -25GM	25GM	858.00
PB-8817	SAFRANINE FOR MICROSCOPY-1KG	1KG	24648.00
PB-8818	SAFRANINE SOLUTIONS (GRAM)-125ML	125ML	241.80
PB-8819	SALICYLAMIDE 99% PURE	500GM	1263.60
PB-8820	SALICYLDEHYDE AZINE	10GM	10951.20
PB-8821	SALICYLIC ACID AR-500GM	500GM	826.80
PB-8822	SALICYLIC ACID LR-500GM	500GM	787.80
PB-8823	SALICYLIC ACID LR-5KG	5KG	7417.80
PB-8824	SAMARIUM OXIDE AR 99.9%-10GM	10GM	1068.60
PB-8825	SAMARIUM OXIDE AR 99.9%-25GM	25GM	2152.80

CODE	PRODUCT	PACKING	PRICE
PB-8826	SAPONIN PURIFIED-100GM	100GM	3042.00
PB-8827	SAPONIN PURIFIED-500GM	500GM	12714.00
PB-8828	S-BENZYLTHIURONIUM CHLORIDE FOR SYNTHESIS-100GM	100GM	780.00
PB-8829	S-BENZYLTHIURONIUM CHLORIDE FOR SYNTHESIS-25GM	25GM	234.00
PB-8830	S-BENZYLTHIURONIUM CHLORIDE FOR SYNTHESIS-500GM	500GM	3,143.40
PB-8831	SCHIFF'S REAGENT-500ML	500ML	608.40
PB-8832	SEASAND AR (PARTICLE SIZE 40-150 MESH)-1KG	1KG	6474.00
PB-8833	SEASAND PURIFIED (PARTICLE SIZE 40-150 MESH)	1KG	4056.00
PB-8834	SEBACIC ACID 98% for synthesis-500GM	500GM	1037.40
PB-8835	SELENIUM DIOXIDE-100GM	100GM	4524.00
PB-8836	SELENIUM DIOXIDE-500GM	500GM	20280.00
PB-8837	SELENIUM METAL PELLETS (electronic GRADE)-100GM	100GM	13587.60
PB-8838	SELENIUM POWDER -100GM	100GM	5686.20
PB-8839	SELENIUM POWDER -500GM	500GM	26067.60
PB-8840	SELENIUM POWDER BLACK AR-100GM	100GM	6099.60
PB-8841	SELENIUM POWDER BLACK AR-25GM	25GM	1872.00
PB-8842	SELENOUS ACID-100GM	100GM	5148.00
PB-8843	SELENOUS ACID-1KG	1KG	46800.00
PB-8844	SELIWANOFF'S REAGENT (for detection of fructose)-125ML	125ML	257.40
PB-8845	SEMICARBAZIDE HYDROCHLORIDE -100GM	100GM	803.40
PB-8846	SEMICARBAZIDE HYDROCHLORIDE -500GM	500GM	2979.60
PB-8847	SEMICARBAZIDE HYDROCHLORIDE AR-100GM	100GM	928.20
PB-8848	SEMICARBAZIDE HYDROCHLORIDE AR-500GM	500GM	3190.20
PB-8849	SHELLAC FLAKES Arsenic free	500GM	2355.60
PB-8850	SHORR'S STAINING SOLUTION-125ML	125ML	218.40
PB-8851	SILICA GEL 100-200 MESH (FOR COLUMN CHROMATOGRAPHY)-500GM	500GM	904.80
PB-8852	SILICA GEL 200-400 MESH FOR COLUMN CHROMATOGRAPHY-500GM	500GM	1014.00
PB-8853	SILICA GEL 400-700 MESH-500GM	500GM	1092.00
PB-8854	SILICA GEL 60-120 MESH (FOR COLUMN CHROMATOGRAPHY)-500GM	500GM	842.40
PB-8855	SILICA GEL 60-200 MESH-500GM	500GM	936.00
PB-8856	SILICA GEL G FOR THIN LAYER CHROMATOGRAPHY-250GM	250GM	546.00
PB-8857	SILICA GEL G FOR THIN LAYER CHROMATOGRAPHY-500GM	500GM	873.60
PB-8858	SILICA GEL GF 254 FOR TLC-500GM	500GM	4680.00
PB-8859	SILICA GEL H FOR TLC-500GM	500GM	858.00
PB-8860	SILICA GEL HF 254 FOR TLC-500GM	500GM	4368.00
PB-8861	SILICA GEL SELF INDICATING 5-8 MESH (BLUE COARSE)-1KG	1KG	982.80
PB-8862	SILICA GEL SELF INDICATING 5-8 MESH (BLUE COARSE)-500GM	500GM	530.40
PB-8863	SILICA GEL SELF INDICATING (BLUE) 6-20 MESH-1KG	1KG	951.60
PB-8864	SILICA GEL SELF INDICATING (BLUE) 6-20 MESH-500GM	500GM	491.40
PB-8865	SILICIC ACID PRECIPITATED DRIED	500GM	624.00
PB-8866	SILICON (METAL) POWDER 200 Mesh 98.5%	100GM	382.20
PB-8867	SILICON (METAL) POWDER 200 Mesh 98.5%	500GM	1310.40
PB-8868	SILICON ANTIFLOOMING AGENT 30%	100ML	468.00
PB-8869	SILICON ANTIFLOOMING AGENT 30%	500ML	1482.00
PB-8870	SILICON ANTIFLOOMING AGENT 30%	2.5LTR	5772.00
PB-8871	SILICON DIOXIDE	1KG	1138.80
PB-8872	SILICONE HIGH VACUUM GREASE (LAB)-1KG	1KG	4157.40
PB-8873	SILICONE HIGH VACUUM GREASE (LAB)-50GM	50GM	249.60
PB-8874	SILICONE OIL (LAB)-2.5LTR	2.5LTR	4711.20
PB-8875	SILICONE OIL (LAB)-250ML	250ML	569.40
PB-8876	SILICOTUNGSTIC ACID AR-100GM	100GM	3744.00
PB-8877	SILICOTUNGSTIC ACID AR-25GM	25GM	998.40
PB-8878	SILVER (METAL) POWDER 99.9%-100GM	100GM	48250.80
PB-8879	SILVER (METAL) POWDER 99.9%-25GM	25GM	12199.20
PB-8880	SILVER ACETATE-100GM	100GM	23244.00
PB-8881	SILVER ACETATE-25GM	25GM	6162.00

CODE	PRODUCT	PACKING	PRICE
PB-8882	SILVER BROMIDE (LAB) 99%-25GM	25GM	6162.00
PB-8883	SILVER CARBONATE-25GM	25GM	8034.00
PB-8884	SILVER CHLORIDE-100GM	100GM	28860.00
PB-8885	SILVER CHLORIDE-25GM	25GM	7800.00
PB-8886	SILVER DIETHYL DITHIOCARBAMATE AR-25GM	25GM	7566.00
PB-8887	SILVER DIETHYL DITHIOCARBAMATE AR-5GM	5GM	1591.20
PB-8888	SILVER IODIDE (IAB) 99%-25GM	25GM	7800.00
PB-8889	SILVER NITRATE AR-100GM	100GM	21840.00
PB-8890	SILVER NITRATE AR-10GM	10GM	2308.80
PB-8891	SILVER NITRATE AR-25GM	25GM	5772.00
PB-8892	SILVER NITRATE LR-100GM	100GM	20592.00
PB-8893	SILVER NITRATE LR-10GM	10GM	2184.00
PB-8894	SILVER NITRATE LR-25GM	25GM	5460.00
PB-8895	SILVER NITRATE N/10 VOLUMETRIC SOLUTION (0.10)N-500ML	500ML	2574.00
PB-8896	SILVER NITRATE N/50 SOLUTION (0.02)N-500ML	500ML	873.60
PB-8897	SILVER OXIDE AR-25GM	25GM	9984.00
PB-8898	SILVER OXIDE LR-25GM	25GM	8580.00
PB-8899	SILVER SULPHATE AR-100GM	100GM	24336.00
PB-8900	SILVER SULPHATE AR-10GM	10GM	2808.00
PB-8901	SILVER SULPHATE AR-25GM	25GM	6396.00
PB-8902	SILVER SULPHATE LR -10GM	10GM	2496.00
PB-8903	SILVER SULPHATE LR -250GM	250GM	57720.00
PB-8904	SILVER SULPHATE LR -25GM	25GM	6084.00
PB-8905	SODA LIME WITH INDICATOR AR-1KG	1KG	1092.00
PB-8906	SODA LIME WITH INDICATOR AR-1KG	5KG	5226.00
PB-8907	SODAMIDE -100GM	100GM	1068.60
PB-8908	SODAMIDE -500GM	500GM	3533.40
PB-8909	SODIUM (+) TARTRATE PURIFIED (DIHYDRATE) AR-500GM	500GM	1,388.40
PB-8910	SODIUM (+) TARTRATE PURIFIED (DIHYDRATE) -500GM	500GM	1,248.00
PB-8911	SODIUM (META) PERIODATE AR-100GM	100GM	1591.20
PB-8912	SODIUM (META) PERIODATE AR-500GM	500GM	7488.00
PB-8913	SODIUM (META) PERIODATE LR-100GM	100GM	1450.80
PB-8914	SODIUM (META) PERIODATE LR-500GM	500GM	6864.00
PB-8915	SODIUM (META) VANADATE ANHYDROUS-100GM	100GM	1,638.00
PB-8916	SODIUM (META) VANADATE ANHYDROUS-500GM	500GM	6,661.20
PB-8917	SODIUM (METAL) AR (Coated with liquid paraffin)-500GM	500GM	1435.20
PB-8918	SODIUM (METAL) COATED WITH LIQUID PARAFFIN-100GM	100GM	499.20
PB-8919	SODIUM (METAL) COATED WITH LIQUID PARAFFIN-500GM	500GM	1326.00
PB-8920	SODIUM 1-NAPHTHYL PHOSPHATE AR-5GM	5GM	3,322.80
PB-8921	SODIUM ACETATE ANHYDROUS AR-250GM	250GM	343.20
PB-8922	SODIUM ACETATE ANHYDROUS AR-500GM	500GM	592.80
PB-8923	SODIUM ACETATE ANHYDROUS LR-500GM	500GM	413.40
PB-8924	SODIUM ACETATE TRIHYDRATE AR-500GM	500GM	358.80
PB-8925	SODIUM ACETATE TRIHYDRATE LR-500GM	500GM	327.60
PB-8926	SODIUM ALGINATE (Confirming to NF)-500GM	500GM	2340.00
PB-8927	SODIUM ALGINATE (Confirming to NF)-5KG	5KG	21840.00
PB-8928	SODIUM ALGINATE (LOW VISCOSITY)-500GM	500GM	2262.00
PB-8929	SODIUM ALGINATE (LOW VISCOSITY)-5KG	5KG	20592.00
PB-8930	SODIUM ARSENATE AR-100GM	100GM	2730.00
PB-8931	SODIUM ARSENATE AR-250GM	250GM	5148.00
PB-8932	SODIUM ARSENATE AR-500GM	500GM	9516.00
PB-8933	SODIUM ARSENITE AR -100GM	100GM	3978.00
PB-8934	SODIUM ARSENITE AR -250GM	250GM	9360.00
PB-8935	SODIUM ARSENITE AR -500GM	500GM	18408.00
PB-8936	SODIUM ARSENITE SOLUTION AR 0.1N (N/10)-500ML	500ML	1435.20
PB-8937	SODIUM AZIDE AR-100GM	100GM	811.20

CODE	PRODUCT	PACKING	PRICE
PB-8938	SODIUM AZIDE AR-500GM	500GM	2964.00
PB-8939	SODIUM AZIDE-100GM	100GM	624.00
PB-8940	SODIUM AZIDE-500GM	500GM	2652.00
PB-8941	SODIUM BENZOATE -500GM	500GM	624.00
PB-8942	SODIUM BENZOATE -5KG	5KG	5304.00
PB-8943	SODIUM BENZOATE AR-500GM	500GM	967.20
PB-8944	SODIUM BIASELENITE {Sodium Hydrogen Selenite}-100GM	100GM	4945.20
PB-8945	SODIUM BISMUTHATE AR-100GM	100GM	2574.00
PB-8946	SODIUM BISMUTHATE-100GM	100GM	2262.00
PB-8947	SODIUM BISULPHATE AR-500GM	500GM	639.60
PB-8948	SODIUM BISULPHATE LR-500GM	500GM	429.00
PB-8949	SODIUM BISULPHITE AR-500GM	500GM	733.20
PB-8950	SODIUM BISULPHITE LR-500GM	500GM	343.20
PB-8951	SODIUM BOROHYDRIDE-100GM	100GM	1528.80
PB-8952	SODIUM BOROHYDRIDE-500GM	500GM	6630.00
PB-8953	SODIUM BROMATE LR-500GM	500GM	1232.40
PB-8954	SODIUM BROMIDE AR-500GM	500GM	1076.40
PB-8955	SODIUM BROMIDE LR-500GM	500GM	936.00
PB-8956	SODIUM CARBONATE ANHYDROUS AR-500GM	500GM	358.80
PB-8957	SODIUM CARBONATE ANHYDROUS PURE -500GM	500GM	296.40
PB-8958	SODIUM CARBONATE ANHYDROUS PURE -5KG	5KG	2152.80
PB-8959	SODIUM CHLORIDE AR-500GM	500GM	218.40
PB-8960	SODIUM CHLORIDE AR-5KG	5KG	1279.20
PB-8961	SODIUM CHLORIDE LR-500GM	500GM	202.80
PB-8962	SODIUM CHLORIDE LR-5KG	5KG	1123.20
PB-8963	SODIUM CHLORIDE SOLUTION 0.85% w/v	500ML	132.60
PB-8964	SODIUM CHLORITE FLAKES 80%-1KG	1KG	2566.20
PB-8965	SODIUM CHLORITE FLAKES 80%-250GM	250GM	655.20
PB-8966	SODIUM CHROMATE (TETRAHYDRATE) LR -500GM	500GM	717.60
PB-8967	SODIUM CHROMATE(TETRAHYDRATE) AR-500GM	500GM	889.20
PB-8968	SODIUM CITRATE SOLUTION 3.8 % w / v	500ML	152.88
PB-8969	SODIUM COBALTINITRITR AR-100GM	100GM	3276.00
PB-8970	SODIUM COBALTINITRITR LR-100GM	100GM	2652.00
PB-8971	SODIUM DEOXYCHOLATE (Culture Media Additive)-100GM	100GM	9516.00
PB-8972	SODIUM DEOXYCHOLATE (Culture Media Additive)-25GM	25GM	2652.00
PB-8973	SODIUM DICHLOROISOCYANURATE	500GM	1669.20
PB-8974	SODIUM DICHRMATE AR (DIHYDRATE)-500GM	500GM	1092.00
PB-8975	SODIUM DICHRMATE (DIHYDRATE) LR-500GM	500GM	1037.40
PB-8976	SODIUM DIETHYL DITHIOCARBOMATE AR-100GM	100GM	663.00
PB-8977	SODIUM DIETHYL DITHIOCARBOMATE AR-500GM	500GM	2566.20
PB-8978	SODIUM DIETHYL DITHIOCARBOMATE-100GM	100GM	569.40
PB-8979	SODIUM DIETHYL DITHIOCARBOMATE-500GM	500GM	2285.40
PB-8980	SODIUM DIHYDROGEN ORTHOPHOSPHATE (DIHYDRATE) LR	5KG	4446.00
PB-8981	SODIUM DIHYDROGEN ORTHOPHOSPHATE (DIHYDRATE) LR-500GM	500GM	546.00
PB-8982	SODIUM DIHYDROGEN ORTHOPHOSPHATE (MONOHYDRATE) LR	500GM	569.40
PB-8983	SODIUM DIHYDROGEN ORTHOPHOSPHATE AR (DIHYDRATE)-500GM	500GM	608.40
PB-8984	SODIUM DIPHENYLAMINE SULPHONATE AR-25GM	25GM	1357.20
PB-8985	SODIUM DIPHENYLAMINE SULPHONATE AR-5GM	5GM	343.20
PB-8986	SODIUM DITHIONITE PURIFIED-500GM	500GM	936.00
PB-8987	SODIUM FLUORIDE AR-500GM	500GM	928.20
PB-8988	SODIUM FLUORIDE-100GM	100GM	140.40
PB-8989	SODIUM FLUORIDE-500GM	500GM	678.60
PB-8990	SODIUM FLUOROBORATE 97%-500GM	500GM	717.60
PB-8991	SODIUM FORMALDEHYDE SULFOXALATE PURE-2.5KG	2.5KG	3400.80
PB-8992	SODIUM FORMALDEHYDE SULFOXALATE PURE-500GM	500GM	748.80
PB-8993	SODIUM FORMATE LR-500GM	500GM	483.60

CODE	PRODUCT	PACKING	PRICE
PB-8994	SODIUM GLUCONATE FOR SYNTHESIS-500GM	500GM	452.40
PB-8995	SODIUM HEXAMETAPHOSPHATE 68% PURIFIED-500GM	500GM	452.40
PB-8996	SODIUM HEXAMETAPHOSPHATE 68% PURIFIED-5KG	5KG	4,212.00
PB-8997	SODIUM HEXAMETAPHOSPHATE PRACT 62%-500GM	500GM	421.20
PB-8998	SODIUM HYDROGEN CARBONATE AR-500GM	500GM	249.60
PB-8999	SODIUM HYDROGEN CARBONATE PURIFIED-1KG	1KG	312.00
PB-9000	SODIUM HYDROGEN CARBONATE PURIFIED-500GM	500GM	187.20
PB-9001	SODIUM HYDROGEN CARBONATE PURIFIED-5KG	5KG	1,591.20
PB-9002	SODIUM HYDROXIDE 50% SOLUTION IN WATER AR	500ML	483.60
PB-9003	SODIUM HYDROXIDE FLAKES-500GM	500GM	249.60
PB-9004	SODIUM HYDROXIDE FLAKES-5KG	5KG	1,591.20
PB-9005	SODIUM HYDROXIDE PELLETS AR-500GM	500GM	468.00
PB-9006	SODIUM HYDROXIDE PELLETS AR-5KG	5KG	2,964.00
PB-9007	SODIUM HYDROXIDE PELLETS LR-500GM	500GM	405.60
PB-9008	SODIUM HYDROXIDE PELLETS LR-5KG	5KG	2,574.00
PB-9009	SODIUM HYDROXIDE SOLUTION N/10-500ML	500ML	210.60
PB-9010	SODIUM HYPOCHLORITE SOLUTION-1LTR	1LTR	390.00
PB-9011	SODIUM HYPOCHLORITE SOLUTION-500ML	500ML	218.40
PB-9012	SODIUM HYPOCHLORITE SOLUTION-5LTR	5LTR	889.20
PB-9013	SODIUM HYPOPHOSPHITE (MONOHYDRATE) AR-500GM	500GM	1,014.00
PB-9014	SODIUM HYPOPHOSPHITE (MONOHYDRATE)-500GM	500GM	787.80
PB-9015	SODIUM IODATE 99%	100GM	2,012.40
PB-9016	SODIUM IODIDE AR-100GM	100GM	2,262.00
PB-9017	SODIUM IODIDE AR-250GM	250GM	5,460.00
PB-9018	SODIUM IODIDE LR-100GM	100GM	1,950.00
PB-9019	SODIUM IODIDE LR-250GM	250GM	4,524.00
PB-9020	SODIUM L (+) ASCORBATE-100GM	100GM	936.00
PB-9021	SODIUM L (+) ASCORBATE-500GM	500GM	4368.00
PB-9022	SODIUM LACTATE 60% SOLN.	500ML	624.00
PB-9023	SODIUM LACTATE 60% SOLN.	2.5LTR	2,496.00
PB-9024	SODIUM LAURYL SULPHATE (NEEDLE-SHAPE)-500GM	500GM	764.40
PB-9025	SODIUM LAURYL SULPHATE (NEEDLE-SHAPE)-5KG	5KG	7316.40
PB-9026	SODIUM LAURYL SULPHATE AR 99% for Electrophoresis-100GM	100GM	2,067.00
PB-9027	SODIUM LAURYL SULPHATE AR 99% for Electrophoresis-250GM	250GM	4,992.00
PB-9028	SODIUM LAURYL SULPHATE AR HPLC-10GM	10GM	1,053.00
PB-9029	SODIUM LAURYL SULPHATE AR HPLC-25GM	25GM	2,028.00
PB-9030	SODIUM LAURYL SULPHATE POWDER LR-500GM	500GM	858.00
PB-9031	SODIUM LAURYL SULPHATE POWDER LR-500GM	5KG	7,332.00
PB-9032	SODIUM MALONATE For Microbiology-100GM	100GM	1,060.80
PB-9033	SODIUM MALONATE For Microbiology-25GM	25GM	343.20
PB-9034	SODIUM MALONATE For Microbiology-500GM	500GM	3,978.00
PB-9035	SODIUM METABISULPHITE AR-1KG	1KG	561.60
PB-9036	SODIUM METABISULPHITE AR-500GM	500GM	312.00
PB-9037	SODIUM METABISULPHITE AR-5KG	5KG	2,496.00
PB-9038	SODIUM METABISULPHITE LR-1KG	1KG	483.60
PB-9039	SODIUM METABISULPHITE LR-500GM	500GM	257.40
PB-9040	SODIUM METABISULPHITE LR-5KG	5KG	1,950.00
PB-9041	SODIUM METABORATE TETRAHYDRATE LR-500GM	500GM	514.80
PB-9042	SODIUM METHOXIDE POWDER LR-500GM	500GM	1,014.00
PB-9043	SODIUM MOLYBDATE AR (DIHYDRATE)-100GM	100GM	1,232.40
PB-9044	SODIUM MOLYBDATE AR (DIHYDRATE)-250GM	250GM	2,886.00
PB-9045	SODIUM MOLYBDATE AR (DIHYDRATE)-500GM	500GM	5,382.00
PB-9046	SODIUM MOLYBDATE LR (DIHYDRATE)-100GM	100GM	1,060.80
PB-9047	SODIUM MOLYBDATE LR (DIHYDRATE)-250GM	250GM	2,574.00
PB-9048	SODIUM MOLYBDATE LR (DIHYDRATE)-500GM	500GM	4,836.00
PB-9049	SODIUM NITRATE AR-500GM	500GM	444.60

CODE	PRODUCT	PACKING	PRICE
PB-9050	SODIUM NITRATE LR-500GM	500GM	358.80
PB-9051	SODIUM NITRITE AR-500GM	500GM	468.00
PB-9052	SODIUM NITRITE LR-500GM	500GM	413.40
PB-9053	SODIUM NITROPRUSIDE AR-100GM	100GM	1,037.40
PB-9054	SODIUM NITROPRUSIDE AR-500GM	500GM	4,297.80
PB-9055	SODIUM NITROPRUSIDE LR-100GM	100GM	904.80
PB-9056	SODIUM NITROPRUSIDE LR-500GM	500GM	3978.00
PB-9057	SODIUM OXALATE AR-500GM	500GM	655.20
PB-9058	SODIUM OXALATE LR -500GM	500GM	514.80
PB-9059	SODIUM PENTACHLOROPHENATE (Santobrite)-500GM	500GM	468.00
PB-9060	SODIUM PERBORATE (TRIHYDRATE PURE)-1KG	1KG	670.80
PB-9061	SODIUM PERBORATE (TRIHYDRATE PURE)-500GM	500GM	343.20
PB-9062	SODIUM PERCARBONATE TABLET-1KG	1KG	608.40
PB-9063	SODIUM PEROXIDE AR (GRANULAR)-1KG	1KG	42,120.00
PB-9064	SODIUM PEROXIDE FOR SYNTHESIS (GRANULAR)-1KG	1KG	40,560.00
PB-9065	SODIUM PERSULPHATE AR-500GM	500GM	748.80
PB-9066	SODIUM PERSULPHATE LR (Sodium peroxydisulfate)-500GM	500GM	608.40
PB-9067	SODIUM PHOSPHATE DIBASIC (DODECAHYDRATE) AR-500GM	500GM	624.00
PB-9068	SODIUM PHOSPHATE DIBASIC (DODECAHYDRATE)LR-500GM	500GM	577.20
PB-9069	SODIUM PHOSPHATE DIBASIC ANHYDROUS AR-500GM	500GM	663.00
PB-9070	SODIUM PHOSPHATE DIBASIC ANHYDROUS-500GM	500GM	561.60
PB-9071	SODIUM PHOSPHATE DIBASIC ANHYDROUS-5KG	5KG	5460.00
PB-9072	SODIUM PHOSPHATE DIBASIC DIHYDRATE AR-500GM	500GM	663.00
PB-9073	SODIUM PHOSPHATE DIBASIC DIHYDRATE-500GM	500GM	514.80
PB-9074	SODIUM PHOSPHATE DIBASIC DIHYDRATE-5KG	5KG	4836.00
PB-9075	SODIUM PROPIONATE LR 98%	500GM	569.40
PB-9076	SODIUM PYRUVATE FOR BIOCHEMISTRY -100GM	100GM	1981.20
PB-9077	SODIUM PYRUVATE FOR BIOCHEMISTRY -25GM	25GM	561.60
PB-9078	SODIUM SALICYLATE AR-250GM	250GM	2,340.00
PB-9079	SODIUM SALICYLATE PURIFIED-500GM	500GM	702.00
PB-9080	SODIUM SELENATE AR ANHYDROUS-100GM	100GM	4,851.60
PB-9081	SODIUM SELENATE AR ANHYDROUS-1KG	1KG	44,647.20
PB-9082	SODIUM SELENITE AR (ANHYDROUS)-100GM	100GM	4,368.00
PB-9083	SODIUM SELENITE AR (ANHYDROUS)-25GM	25GM	1,092.00
PB-9084	SODIUM SELENITE LR (ANHYDROUS)-100GM	100GM	3,978.00
PB-9085	SODIUM SELENITE LR (ANHYDROUS)-1KG	1KG	36,660.00
PB-9086	SODIUM SELENITE(PENTAHYDRATE)LR (CONFIRMING TO B.P.)	100GM	4,212.00
PB-9087	SODIUM SELENITE(PENTAHYDRATE)LR (CONFIRMING TO B.P.)	500GM	18,306.60
PB-9088	SODIUM SILICATE POWDER (META) HYDRATED-1KG	1KG	663.00
PB-9089	SODIUM SILICATE POWDER (META) HYDRATED-500GM	500GM	413.40
PB-9090	SODIUM SILICATE SOLUTION-5LTR	5LTR	1248
PB-9091	SODIUM SILICOFUORIDE 98%-1KG	1KG	585.00
PB-9092	SODIUM STANNATE LR-500GM	500GM	6,006.00
PB-9093	SODIUM SULPHATE ANHYDROUS AR-1KG	1KG	561.60
PB-9094	SODIUM SULPHATE ANHYDROUS AR-500GM	500GM	312.00
PB-9095	SODIUM SULPHATE ANHYDROUS PURIFIED-1KG	1KG	436.80
PB-9096	SODIUM SULPHATE ANHYDROUS PURIFIED-500GM	500GM	234.00
PB-9097	SODIUM SULPHATE ANHYDROUS PURIFIED-5KG	5KG	1,591.20
PB-9098	SODIUM SULPHIDE FLAKES (IRON FREE) LR-500GM	500GM	319.80
PB-9099	SODIUM SULPHIDE FLAKES AR-500GM	500GM	1,872.00
PB-9100	SODIUM SULPHITE ANHYDROUS AR-500GM	500GM	405.60
PB-9101	SODIUM SULPHITE ANHYDROUS LR-500GM	500GM	296.40
PB-9102	SODIUM tert-BUTOXIDE 98% -100GM	100GM	928.20
PB-9103	SODIUM tert-BUTOXIDE 98% -500GM	500GM	3260.40
PB-9104	SODIUM THIOCYANATE AR-500GM	500GM	1,287.00
PB-9105	SODIUM THIOCYANATE LR-500GM	500GM	865.80

CODE	PRODUCT	PACKING	PRICE
PB-9106	SODIUM THIOSULPHATE AR (PENTAHYDRATE)-500GM	500GM	327.60
PB-9107	SODIUM THIOSULPHATE PURE (PENTAHYDRATE)-1KG	1KG	436.80
PB-9108	SODIUM THIOSULPHATE PURE (PENTAHYDRATE)-500GM	500GM	249.60
PB-9109	SODIUM THIOSULPHATE PURE (PENTAHYDRATE)-5KG	5KG	1,872.00
PB-9110	SODIUM TRIPOLYPHOSPHATE(ANHYDROUS) STPP-1KG	1KG	639.60
PB-9111	SODIUM TUNGSTATE (DIHYDRATE) AR-100GM	100GM	1,341.60
PB-9112	SODIUM TUNGSTATE (DIHYDRATE) AR-250GM	250GM	3,190.20
PB-9113	SODIUM TUNGSTATE (DIHYDRATE)-100GM	100GM	1,177.80
PB-9114	SODIUM TUNGSTATE (DIHYDRATE)-250GM	250GM	2,776.80
PB-9115	SODIUM-B-GLYCEROPHOSPHATE AR-100GM	100GM	3276.00
PB-9116	SODIUM-B-GLYCEROPHOSPHATE AR-25GM	25GM	936.00
PB-9117	SOLOCHROME DARK BLUE (CALCON)-25GM	25GM	1,341.60
PB-9118	SOLOCHROME DARK BLUE (CALCON)-5GM	5GM	475.80
PB-9119	SORBIC ACID PURISS-500GM	500GM	1,638.00
PB-9120	SORBIC ACID PURISS-5KG	5KG	15,288.00
PB-9121	SORBITOL 70% LIQUID (CONFIRMING TO PHARMA SPECIFICATION)	500ML	296.40
PB-9122	SOYA LECITHIN 30%	100GM	4,087.20
PB-9123	SOYA LECITHIN 30%	500GM	18,579.60
PB-9124	SOYA PEPTONE (SOYATONE)-500GM	500GM	1,427.40
PB-9125	SOYABEAN MEAL (defatted)-500GM	500GM	265.20
PB-9126	SPADNS AR-1GM	1GM	468.00
PB-9127	SPADNS AR-25GM	25GM	5,272.80
PB-9128	SPADNS AR-5GM	5GM	1,825.20
PB-9129	SPAN 20 (Sorbitan Monolaurate)-500ML	500ML	795.60
PB-9130	SPAN 40 (Sorbitan Monopalmitate)-500GM	500GM	842.40
PB-9131	SPAN 60 ((Sorbitane Monostearate)-500GM	500GM	904.80
PB-9132	SPAN 80 (SORBITANE MONOOLEATE)-2.5LTR	2.5LTR	3,744.00
PB-9133	SPAN 80 (SORBITANE MONOOLEATE)-500ML	500ML	850.20
PB-9134	STANNIC CHLORIDE HYDRATED 98%-500GM	500GM	2,776.80
PB-9135	STANNIC OXIDE AR-250GM	250GM	5,413.20
PB-9136	STANNIC OXIDE LR-500GM	500GM	8,182.20
PB-9137	STANNOUS CHLORIDE (Tin chloride)-100GM	100GM	904.80
PB-9138	STANNOUS CHLORIDE (Tin chloride)-250GM	250GM	2,106.00
PB-9139	STANNOUS CHLORIDE AR-100GM	100GM	1,060.80
PB-9140	STANNOUS CHLORIDE AR-250GM	250GM	2,293.20
PB-9141	STANNOUS SULPHATE AR-250GM	250GM	4,024.80
PB-9142	STANNOUS SULPHATE LR-500GM	500GM	4,648.80
PB-9143	STARCH IODIDE PAPER -200IVS	200IVS	210.60
PB-9144	STARCH MAIZE (CORN)	500GM	304.20
PB-9145	STARCH MAIZE (CORN)	5KG	2,698.80
PB-9146	STARCH POTATO-500GM	500GM	288.60
PB-9147	STARCH POTATO-5KG	5KG	2,698.80
PB-9148	STARCH SOLUBLE (EX POTATO)-500GM	500GM	1,037.40
PB-9149	STARCH SOLUBLE AR (EX POTATO)-500GM	500GM	1,177.80
PB-9150	STEARIC ACID FOR SYNTHESIS-500GM	500GM	538.20
PB-9151	STEARYL ALCOHOL PURE (alcohol C18)-500GM	500GM	655.20
PB-9152	STRONTIUM CARBONATE LR-250GM	250GM	670.80
PB-9153	STRONTIUM CARBONATE LR-500GM	500GM	1216.80
PB-9154	STRONTIUM CHLORIDE LR-500GM	500GM	686.40
PB-9155	STRONTIUM NITRATE ANHYDROUS LR-500GM	500GM	702.00
PB-9156	STRONTIUM SULFATE (ANHYDROUS) LR 98%-500GM	500GM	733.20
PB-9157	SUCCINIC ACID AR-100GM	100GM	678.60
PB-9158	SUCCINIC ACID AR-500GM	500GM	3049.80
PB-9159	SUCCINIC ACID FOR SYNTHESIS-500GM	500GM	897.00
PB-9160	SUCCINIC ANHYDRIDE FOR SYNTHESIS-100GM	100GM	436.80
PB-9161	SUCCINIC ANHYDRIDE FOR SYNTHESIS-500GM	500GM	1560.00

CODE	PRODUCT	PACKING	PRICE
PB-9162	SUCCINIMIDE 99%-100GM	100GM	585.00
PB-9163	SUCCINIMIDE 99%-500GM	500GM	2496.00
PB-9164	SUCROSE AR-500GM	500GM	624.00
PB-9165	SUCROSE LR-1KG	1KG	686.40
PB-9166	SUCROSE LR-500GM	500GM	390.00
PB-9167	SUDAN BLACK B FOR MICROSCOPY-100GM	100GM	9204.00
PB-9168	SUDAN BLACK B FOR MICROSCOPY-10GM	10GM	1248.00
PB-9169	SUDAN BLACK B FOR MICROSCOPY-25GM	25GM	2496.00
PB-9170	SUDAN III FOR MICROSCOPY-100GM	100GM	780.00
PB-9171	SUDAN III FOR MICROSCOPY-10GM	10GM	249.60
PB-9172	SUDAN III FOR MICROSCOPY-25GM	25GM	374.40
PB-9173	SUDAN IV FOR MICROSCOPY-100GM	100GM	951.60
PB-9174	SUDAN IV FOR MICROSCOPY-10GM	10GM	163.80
PB-9175	SUDAN IV FOR MICROSCOPY-25GM	25GM	312.00
PB-9176	SULPHAMIC ACID AR-100GM	100GM	390.00
PB-9177	SULPHAMIC ACID AR-500GM	500GM	1,778.40
PB-9178	SULPHAMIC ACID-500GM	500GM	358.80
PB-9179	SULPHAMIC ACID-5KG	5KG	3,073.20
PB-9180	SULPHANILAMIDE AR-100GM	100GM	842.40
PB-9181	SULPHANILAMIDE AR-500GM	500GM	4212.00
PB-9182	SULPHANILAMIDE LR-500GM	500GM	2808.00
PB-9183	SULPHANILIC ACID AR-100GM	100GM	468.00
PB-9184	SULPHANILIC ACID AR-500GM	500GM	1,981.20
PB-9185	SULPHANILIC ACID-100GM	100GM	390.00
PB-9186	SULPHANILIC ACID-500GM	500GM	1,450.80
PB-9187	SULPHOSALICYLIC ACID SOLUTION 10% w / v	125ML	163.80
PB-9188	SULPHOSALICYLIC ACID SOLUTION 20% w / v	125ML	171.60
PB-9189	SULPHOSALICYLIC ACID SOLUTION 3% w / v	125ML	156.00
PB-9190	SULPHURIC ACID 25% v/v	500ML	171.60
PB-9191	SULPHURIC ACID AR-2.5LTR	2.5LTR	1,279.20
PB-9192	SULPHURIC ACID AR-500ML	500ML	429.00
PB-9193	SULPHURIC ACID AR-5LTR	5LTR	2,106.00
PB-9194	SULPHURIC ACID LR-2.5LTR	2.5LTR	1,138.80
PB-9195	SULPHURIC ACID LR-500ML	500ML	374.40
PB-9196	SULPHURIC ACID LR-5LTR	5LTR	1,684.80
PB-9197	SULPHURIC ACID N/50 -500ML	500ML	226.20
PB-9198	TALC FINE POWDER LR-500GM	500GM	202.80
PB-9199	TANNIC ACID AR-100GM	100GM	1,279.20
PB-9200	TANNIC ACID AR-250GM	250GM	2,652.00
PB-9201	TANNIC ACID POWDER PURE-100GM	100GM	1,201.20
PB-9202	TANNIC ACID POWDER PURE-250GM	250GM	2,425.80
PB-9203	TANTALUM PENTOXIDE AR-10GM	10GM	6,169.80
PB-9204	TANTALUM PENTOXIDE AR-50GM	50GM	27,596.40
PB-9205	TAPS BUFFER FOR BIOCHEMISTRY-100GM	100GM	4,024.80
PB-9206	TAPS BUFFER FOR BIOCHEMISTRY-25GM	25GM	1,388.40
PB-9207	TARTARIC ACID AR (+) DEXTRORATORY-500GM	500GM	1,661.40
PB-9208	TARTARIC ACID LR (+) DEXTRORATORY-500GM	500GM	1,435.20
PB-9209	TARTARIC ACID LR (+) DEXTRORATORY-5KG	5KG	11,232.00
PB-9210	TARTRAZINE AR FOR MICROSCOPY-100GM	100GM	655.20
PB-9211	TARTRAZINE AR FOR MICROSCOPY-25GM	25GM	249.60
PB-9212	TAURINE FOR BIOCHEMISTRY (2-AMINOETHANE SULPHONIC ACID)-100GM	100GM	2,449.20
PB-9213	TAURINE FOR BIOCHEMISTRY (2-AMINOETHANE SULPHONIC ACID)-25GM	25GM	733.20
PB-9214	TBTU FOR SYNTHESIS-100GM	100GM	8,041.80
PB-9215	TBTU FOR SYNTHESIS-25GM	25GM	2,012.40
PB-9216	TBTU FOR SYNTHESIS-5GM	5GM	553.80
PB-9217	TELLURIUM (METAL) POWDER -100GM	100GM	18,720.00

CODE	PRODUCT	PACKING	PRICE
PB-9218	TEMPO FREE RADICAL FOR SYNTHESIS-25GM	25GM	7,347.60
PB-9219	TEMPO FREE RADICAL FOR SYNTHESIS-5GM	5GM	1,942.20
PB-9220	TEREPHTHALIC ACID PURE-500GM	500GM	413.40
PB-9221	tert-AMYL ALCOHOL FOR SYNTHESIS	500ML	1,037.40
PB-9222	tert-AMYL ALCOHOL FOR SYNTHESIS	2.5LTR	4,851.60
PB-9223	tert-BUTANOL 99% AR	2.5LTR	2,355.60
PB-9224	tert-BUTANOL 99% AR - 500ML	500ML	592.80
PB-9225	tert-BUTANOL LR 98.5%-2.5LTR	2.5LTR	2,145.00
PB-9226	tert-BUTANOL LR 98.5%-500ML	500ML	514.80
PB-9227	tert-BUTYL HYDROQUINONE (TBHQ)-2.5KG	2.5KG	11,645.40
PB-9228	tert-BUTYL HYDROQUINONE (TBHQ)-250GM	250GM	1,177.80
PB-9229	tert-BUTYL METHYL ETHER AR 99.5%-2.5LTR	2.5LTR	3,814.20
PB-9230	tert-BUTYL METHYL ETHER AR 99.5%-500ML	500ML	943.80
PB-9231	tert-BUTYL METHYL ETHER FOR HPLC 99.7%	1LTR	2,425.80
PB-9232	tert-BUTYL METHYL ETHER FOR HPLC 99.7%	2.5LTR	4,711.20
PB-9233	tert-BUTYL METHYL ETHER LR 99%-2.5LTR	2.5LTR	2,558.40
PB-9234	tert-BUTYL METHYL ETHER LR 99%-500ML	500ML	592.80
PB-9235	TERT-BUTYLAMINE FOR SYNTHESIS 99%	500ML	1,037.40
PB-9236	TERT-BUTYLAMINE FOR SYNTHESIS 99%	2.5LTR	4,711.20
PB-9237	tert-BUTYLDIMETHYLSILYL CHLORIDE FOR SYNTHESIS-100GM	100GM	2,698.80
PB-9238	tert-BUTYLDIMETHYLSILYL CHLORIDE FOR SYNTHESIS-500GM	500GM	8,595.60
PB-9239	TES BUFFER FOR BIOCHEMISTRY-25GM	25GM	2,730.00
PB-9240	TES BUFFER FOR BIOCHEMISTRY-5GM	5GM	694.20
PB-9241	TETRA BUTYL AMMONIUM HYDROXIDE 20% AQUEOUS SOLUTION-100ML	100ML	2496.00
PB-9242	TETRA BUTYL AMMONIUM HYDROXIDE 20% AQUEOUS SOLUTION-500ML	500ML	10608.00
PB-9243	TETRA BUTYL AMMONIUM HYDROXIDE 25% IN METHANOL-100ML	100ML	2730.00
PB-9244	TETRA BUTYL AMMONIUM HYDROXIDE 25% IN METHANOL-250ML	250ML	6240.00
PB-9245	TETRA BUTYL AMMONIUM HYDROXIDE 40% AQUEOUS SOLUTION-100ML	100ML	4992.00
PB-9246	TETRA BUTYL AMMONIUM HYDROXIDE 10% IN METHANOL-100ML	100ML	1950.00
PB-9247	TETRA BUTYL AMMONIUM HYDROXIDE 0.1 NORMAL IN IPA	500ML	1872.00
PB-9248	TETRA BUTYL AMMONIUM HYDROXIDE 10% AQUEOUS SOLUTION	100ML	2184.00
PB-9249	TETRA BUTYL AMMONIUM HYDROXIDE 40% IN METHANOL-100ML	100ML	4680.00
PB-9250	TETRA BUTYL AMMONIUM HYDROXIDE 40% IN METHANOL-250ML	250ML	10764.00
PB-9251	TETRA DECYLAMMONIUM BROMIDE AR FOR HPLC -10GM	10GM	13650.00
PB-9252	TETRA DECYLAMMONIUM BROMIDE AR FOR HPLC -25GM	25GM	32,760.00
PB-9253	TETRA DECYLAMMONIUM BROMIDE AR FOR HPLC -5GM	5GM	6942.00
PB-9254	TETRA HEPTYL AMMONIUM BROMIDE AR-100GM	100GM	49,140.00
PB-9255	TETRA HEPTYL AMMONIUM BROMIDE AR-25GM	25GM	12,402.00
PB-9256	TETRA METHYL AMMONIUM HYDROXIDE (AQUEOUS SOLUTION) 10% -100ML	100ML	2,355.60
PB-9257	TETRA METHYL AMMONIUM HYDROXIDE (AQUEOUS SOLUTION) 10% -250ML	250ML	4,087.20
PB-9258	TETRA PROPYL AMMONIUM BROMIDE LR-100GM	100GM	1,107.60
PB-9259	TETRA PROPYL AMMONIUM BROMIDE LR-500GM	500GM	4,570.80
PB-9260	TETRA PROPYL AMMONIUM HYDROXIDE 20% AQUEOUS SOLUTION-100ML	100ML	2418.00
PB-9261	TETRA PROPYL AMMONIUM HYDROXIDE 20% AQUEOUS SOLUTION-500ML	500ML	10920.00
PB-9262	TETRA PROPYL AMMONIUM HYDROXIDE 40% AQUEOUS SOLUTION -100ML	100ML	4,687.80
PB-9263	TETRA PROPYL AMMONIUM HYDROXIDE 40% AQUEOUS SOLUTION -500ML	500ML	20,521.80
PB-9264	TETRABUTYL AMMONIUM BROMIDE AR-100GM	100GM	694.20
PB-9265	TETRABUTYL AMMONIUM BROMIDE AR-500GM	500GM	3,010.80
PB-9266	TETRABUTYL AMMONIUM BROMIDE FOR SYNTHESIS- 1KG	1KG	2808.00
PB-9267	TETRABUTYL AMMONIUM BROMIDE FOR SYNTHESIS-250GM	250GM	780.00
PB-9268	TETRABUTYL AMMONIUM DIHYDROGEN PHOSPHATE AR HPLC-25GM	25GM	17160.00
PB-9269	TETRABUTYL AMMONIUM DIHYDROGEN PHOSPHATE AR HPLC-5GM	5GM	4524.00
PB-9270	TETRABUTYL AMMONIUM HYDROGEN SULPHATE FOR SYNTHESIS-100GM	100GM	733.20
PB-9271	TETRABUTYL AMMONIUM HYDROGEN SULPHATE FOR SYNTHESIS-500GM	500GM	2964.00
PB-9272	TETRABUTYL AMMONIUM IODIDE AR (phase transfer catalyst) 100GM	100GM	2418.00
PB-9273	TETRABUTYL AMMONIUM IODIDE AR (phase transfer catalyst)-25GM	25GM	624.00

CODE	PRODUCT	PACKING	PRICE
PB-9274	TETRACHLOROETHYLENE AR-2.5LTR	2.5LTR	3276.00
PB-9275	TETRACHLOROETHYLENE AR-500ML	500ML	748.80
PB-9276	TETRACHLOROETHYLENE LR (Perchloroethylene)-2.5LTR	2.5LTR	2886.00
PB-9277	TETRACHLOROETHYLENE LR (Perchloroethylene)-500ML	500ML	608.40
PB-9278	TETRAETHYL AMMONIUM BROMIDE FOR SYNTHESIS-100GM	100GM	468.00
PB-9279	TETRAETHYL AMMONIUM BROMIDE FOR SYNTHESIS-1KG	1KG	3,588.00
PB-9280	TETRAETHYL AMMONIUM BROMIDE FOR SYNTHESIS-250GM	250GM	1,092.00
PB-9281	TETRAETHYL AMMONIUM HYDROGEN SULPHATE FOR HPLC99%-100GM	100GM	4,446.00
PB-9282	TETRAETHYL AMMONIUM HYDROGEN SULPHATE FOR HPLC99%-25GM	25GM	1,326.00
PB-9283	TETRAETHYL AMMONIUM IODIDE FOR SYNTHESIS-100GM	100GM	3,432.00
PB-9284	TETRAETHYL AMMONIUM IODIDE FOR SYNTHESIS-500GM	500GM	17,472.00
PB-9285	TETRAHYDROFURAN AR STABILISED SPECIALLY DRIED-2.5LTR	2.5LTR	3,744.00
PB-9286	TETRAHYDROFURAN AR STABILISED SPECIALLY DRIED-500ML	500ML	826.80
PB-9287	TETRAHYDROFURAN FOR HPLC-1LTR	1LTR	2,012.40
PB-9288	TETRAHYDROFURAN STABILISED FOR SYNTHESIS-2.5LTR	2.5LTR	3,564.60
PB-9289	TETRAHYDROFURAN STABILISED FOR SYNTHESIS-500ML	500ML	733.20
PB-9290	TETRALIN FOR SYNTHESIS 98% (1 2 3 4-Tetrahydronaphthalene	500ML	2,152.80
PB-9291	TETRALIN FOR SYNTHESIS 98% (1 2 3 4-Tetrahydronaphthalene	2.5LTR	9,562.80
PB-9292	TETRAMETHYL AMMONIUM HYDROXIDE SOLUTION 25% IN METHANOL-100ML	100ML	4524.00
PB-9293	TETRAMETHYL AMMONIUM HYDROXIDE SOLUTION 25% IN METHANOL-250ML	250ML	7,800.00
PB-9294	TETRAMETHYL AMMONIUM BROMIDE FOR SYNTHESIS-100GM	100GM	1326.00
PB-9295	TETRAMETHYL AMMONIUM BROMIDE FOR SYNTHESIS-500GM	500GM	6396.00
PB-9296	TETRAMETHYL AMMONIUM CHLORIDE FOR SYNTHESIS-100GM	100GM	795.60
PB-9297	TETRAMETHYL AMMONIUM CHLORIDE FOR SYNTHESIS-500GM	500GM	3,588.00
PB-9298	TETRAMETHYL AMMONIUM HYDROGEN SULPHATE MONOHYDRATE FOR SYNTHESIS 98%	100GM	2,917.20
PB-9299	TETRAMETHYL AMMONIUM HYDROXIDE PENTAHYDRATE FOR SYNTHESIS-250GM	100GM	5,405.40
PB-9300	TETRAMETHYL AMMONIUM HYDROXIDE PENTAHYDRATE FOR SYNTHESIS-25GM	25GM	1,661.40
PB-9301	TETRAMETHYL AMMONIUM HYDROXIDE SOLUTION 25%-100ML	100ML	4056.00
PB-9302	TETRAMETHYL AMMONIUM HYDROXIDE SOLUTION 25%-250ML	250ML	9204.00
PB-9303	TETRAMETHYL AMMONIUM IODIDE AR-100GM	100GM	2,176.20
PB-9304	TETRAMETHYL AMMONIUM IODIDE AR-500GM	500GM	8,806.20
PB-9305	TETRANITRO B.T. AR (Tetranitro Blue Tetrazolium Chloride)-100MG	100MG	2,909.40
PB-9306	TETRANITRO B.T. AR (Tetranitro Blue Tetrazolium Chloride)-250MG	250MG	5,959.20
PB-9307	TETRAPHENYL PHOSPHONIUM BROMIDE-100GM	100GM	5,756.40
PB-9308	TETRAPHENYL PHOSPHONIUM BROMIDE-25GM	25GM	1,856.40
PB-9309	TETRA-POTASSIUM PYROPHOSPHATE	500GM	1092.00
PB-9310	tetra-SODIUM PYROPHOSPHATE (ANHYDROUS) LR-500GM	500GM	787.80
PB-9311	tetra-SODIUM PYROPHOSPHATE (DECAHYDRATE) AR	500GM	1,053.00
PB-9312	TETRAZOLIUM SALT AR (TTC) (2,3,5 triphenyl tetrazolium chloride)-10GM	10GM	2,745.60
PB-9313	TETRAZOLIUM SALT AR (TTC) (2,3,5 triphenyl tetrazolium chloride)-25GM	25GM	6,193.20
PB-9314	THEOPHYLLINE (ANHYDROUS)-100GM	100GM	1,248.00
PB-9315	THIAMINE HYDROCHLORIDE FOR BIOCHEMISTRY (VITAMIN B1)-10GM	10GM	514.80
PB-9316	THIAMINE HYDROCHLORIDE FOR BIOCHEMISTRY (VITAMIN B1)-250GM	250GM	8,268.00
PB-9317	THIAMINE HYDROCHLORIDE FOR BIOCHEMISTRY (VITAMIN B1)-25GM	25GM	904.80
PB-9318	THIOACETAMIDE AR-100GM	100GM	2262.00
PB-9319	THIOACETAMIDE AR-25GM	25GM	639.60
PB-9320	THIOACETAMIDE LR-100GM	100GM	1872.00
PB-9321	THIOACETAMIDE LR-500GM	500GM	8424.00
PB-9322	THIOBARBITURIC ACID AR-100GM	100GM	7644.00
PB-9323	THIOBARBITURIC ACID AR-25GM	25GM	2184.00
PB-9324	THIOFLAVINE T	5 GM	1,528.80
PB-9325	THIOFLAVINE T	25GM	3,400.80
PB-9326	THIOGLYCOLLIC ACID AR-100ML	100ML	967.20
PB-9327	THIOGLYCOLLIC ACID AR-250ML	500ML	2,901.60

CODE	PRODUCT	PACKING	PRICE
PB-9328	THIOGLYCOLLIC ACID LR-2.5LTR	2.5LTR	7,909.20
PB-9329	THIOGLYCOLLIC ACID LR-500ML	500ML	1,942.20
PB-9330	THIOMALIC ACID FOR SYNTHESIS (mercaptosuccinic acid)-100GM	100GM	2,355.60
PB-9331	THIOMALIC ACID FOR SYNTHESIS (mercaptosuccinic acid)-1KG	1KG	23,290.80
PB-9332	THIOMERSAL (CONFIRMING TO USP/BP STANDARDS)-100GM	100GM	50856.00
PB-9333	THIOMERSAL (CONFIRMING TO USP/BP STANDARDS)-10GM	10GM	5850.00
PB-9334	THIOMERSAL (CONFIRMING TO USP/BP STANDARDS)-25GM	25GM	13572.00
PB-9335	THIONIN (ACETATE) For Microscopy	5GM	2,355.60
PB-9336	THIONIN (ACETATE) For Microscopy	25GM	10,264.80
PB-9337	THIONYL CHLORIDE FOR SYNTHESIS-2.5LTR	2.5LTR	3198.00
PB-9338	THIONYL CHLORIDE FOR SYNTHESIS-500ML	500ML	702.00
PB-9339	THIOPHENOL LR 98%-2.5LTR	2.5LTR	8,736.00
PB-9340	THIOPHENOL LR 98%-500ML	500ML	1,942.20
PB-9341	THIOSEMICARBAZIDE AR-100GM	100GM	1,794.00
PB-9342	THIOSEMICARBAZIDE AR-25GM	25GM	514.80
PB-9343	THIOSEMICARBAZIDE FOR SYNTHESIS-100GM	100GM	1326.00
PB-9344	THIOSEMICARBAZIDE FOR SYNTHESIS-25GM	25GM	452.40
PB-9345	THIOUREA (PRACT)-500GM	500GM	702.00
PB-9346	THIOUREA (PURIFIED)-500GM	500GM	780.00
PB-9347	THIOUREA AR-500GM	500GM	873.60
PB-9348	THORIN INDICATOR AR-10GM	10GM	19,804.20
PB-9349	THORIN INDICATOR AR-5GM	5GM	9,820.20
PB-9350	THYMIDINE FOR BIOCHEMISTRY 99%	1GM	1294.80
PB-9351	THYMIDINE FOR BIOCHEMISTRY 99%	5GM	5928.00
PB-9352	THYMIDINE FOR BIOCHEMISTRY 99%	25GM	27768.00
PB-9353	THYMINE FOR BIOCHEMISTRY-10GM	10GM	967.20
PB-9354	THYMINE FOR BIOCHEMISTRY-10GM	25GM	1,661.40
PB-9355	THYMOL (CRYSTAL) PURISS -100GM	100GM	873.60
PB-9356	THYMOL (CRYSTAL) PURISS -250GM	250GM	2,012.40
PB-9357	THYMOL BLUE INDICATOR AR-25GM	25GM	936.00
PB-9358	THYMOL BLUE INDICATOR AR-5GM	5GM	280.80
PB-9359	THYMOL BLUE INDICATOR SOLUTION-125ML	125ML	187.20
PB-9360	THYMOL BLUE SODIUM SALT WATER SOLUBLE-5GM	5GM	288.60
PB-9361	THYMOLPHTHALEIN COMPLEXON AR-1GM	1GM	2964.00
PB-9362	THYMOLPHTHALEIN COMPLEXON AR-5GM	5GM	11388.00
PB-9363	THYMOLPHTHALEIN INDICATOR AR-25GM	25GM	1,123.20
PB-9364	THYMOLPHTHALEIN INDICATOR AR-5GM	5GM	296.40
PB-9365	THYMOLPHTHALEIN INDICATOR SOLUTION-125ML	125ML	171.60
PB-9366	TIN (METAL) GRANULAR -100GM	100GM	1544.40
PB-9367	TIN (METAL) GRANULAR -500GM	500GM	7488.00
PB-9368	TIN (METAL) GRANULAR AR-100GM	100GM	1794.00
PB-9369	TIN (METAL) GRANULAR AR-500GM	500GM	8424.00
PB-9370	TIN FLUOBORATE 50%-500GM	500GM	1,591.20
PB-9371	TIN METAL POWDER AR-100GM	100GM	1560.00
PB-9372	TIN METAL POWDER AR-250GM	250GM	4212.00
PB-9373	TITAN YELLOW AR -25GM	25GM	1138.80
PB-9374	TITAN YELLOW GR -10GM	10GM	530.40
PB-9375	TITANIUM DIOXIDE -500GM	500GM	655.20
PB-9376	TITANIUM DIOXIDE AR-500GM	500GM	1404.00
PB-9377	TITANIUM DIOXIDE-1KG	1KG	1279.20
PB-9378	TITANIUM DIOXIDE-5KG	5KG	5,772.00
PB-9379	TITANIUM TRICHLORIDE SOLUTION 15% FOR SYNTHESIS-250ML	250ML	2,012.40
PB-9380	TITANIUM TRICHLORIDE SOLUTION 15% FOR SYNTHESIS-500ML	500ML	3,744.00
PB-9381	TOLLEN'S REAGENT-100ML	100ML	2,496.00
PB-9382	TOLUENE AR-2.5LTR	2.5LT	1,794.00
PB-9383	TOLUENE AR-500ML	500ML	483.60

CODE	PRODUCT	PACKING	PRICE
PB-9384	TOLUENE LR-2.5LTR	2.5LT	1544.40
PB-9385	TOLUENE LR-500ML	500ML	405.60
PB-9386	TOLUENE SPECIALLY DRIED AR	500ML	429.00
PB-9387	TOLUIDINE BLUE FOR MICROSCOPY-100GM	100GM	2,776.80
PB-9388	TOLUIDINE BLUE FOR MICROSCOPY-25GM	25GM	780.00
PB-9389	TOPFER'S REAGENT (SOLUTION)-100ML	100ML	163.80
PB-9390	TOTAL HARDNESS INDICATOR TABLETS -100TAB	100TAB	218.40
PB-9391	trans-1,2-DIAMINOCYCLOHEXANE N,N,N',N'-TETRAACETIC ACID AR-100GM	100GM	12,963.60
PB-9392	trans-1,2-DIAMINOCYCLOHEXANE N,N,N',N'-TETRAACETIC ACID AR-25GM	25GM	3,814.20
PB-9393	trans-1,2-DIAMINOCYCLOHEXANE-N,N,N',N'-TETRAACETIC ACID -100GM	100GM	10,678.20
PB-9394	trans-1,2-DIAMINOCYCLOHEXANE-N,N,N',N'-TETRAACETIC ACID -25GM	25GM	2,870.40
PB-9395	TREHALOSE FOR BIOCHEMISTRY	5GM	717.60
PB-9396	TREHALOSE FOR BIOCHEMISTRY	10GM	1,400.88
PB-9397	TREHALOSE FOR BIOCHEMISTRY	25GM	2,776.80
PB-9398	tri-AMMONIUM CITRATE LR-500GM	500GM	998.40
PB-9399	TRIBUTYLAMINE FOR SYNTHESIS99%	500ML	694.20
PB-9400	TRIBUTYLAMINE FOR SYNTHESIS99%	2.5LTR	3,190.20
PB-9401	tri-CALCIUM PHOSPHATE LR-500GM	500GM	507.00
PB-9402	tri-CALCIUM PHOSPHATE LR-5KG	5KG	4,711.20
PB-9403	TRICHLORO ACETIC ACID-100GM	100GM	234.00
PB-9404	TRICHLORO ACETIC ACID-500GM	500GM	764.40
PB-9405	TRICHLORO ACETIC ACID ACS	500GM	1248.00
PB-9406	TRICHLOROACETIC ACID AR 10% W/V	125ML	156.00
PB-9407	TRICHLOROACETIC ACID AR 20% W/V-500ML	500ML	530.40
PB-9408	TRICHLOROACETIC ACID AR-100GM	100GM	374.40
PB-9409	TRICHLOROACETIC ACID AR-500GM	500GM	1216.80
PB-9410	TRICHLOROETHYLENE AR 99.5%-2.5LTR	2.5LTR	2,776.80
PB-9411	TRICHLOROETHYLENE AR 99.5%-500ML	500ML	655.20
PB-9412	TRICHLOROETHYLENE LR 99%-2.5LTR	2.5LTR	2,496.00
PB-9413	TRICHLOROETHYLENE LR 99%-500ML	500ML	569.40
PB-9414	TRICINE (N-TRIS(HYDROXYMETHYL)METHYL GLYCINE)-100GM	100GM	3,954.60
PB-9415	TRICINE (N-TRIS(HYDROXYMETHYL)METHYL GLYCINE)-25GM	25GM	1,279.20
PB-9416	TRI-CRESYL PHOSPHATE LR	500ML	1,248.00
PB-9417	TRI-CRESYL PHOSPHATE LR	2.5LTR	6,099.60
PB-9418	TRIETHANOLAMINE AR-2.5LTR	2.5LIT	3,400.80
PB-9419	TRIETHANOLAMINE AR-500ML	500ML	826.80
PB-9420	TRIETHANOLAMINE LR-2.5LTR	2.5LIT	3,190.20
PB-9421	TRIETHANOLAMINE LR-500ML	500ML	717.60
PB-9422	TRIETHYLAMINE AR-2.5LTR	2.5LIT	2,215.20
PB-9423	TRIETHYLAMINE AR-500ML	500ML	585.00
PB-9424	TRIETHYLAMINE HPLC	500ML	2,355.60
PB-9425	TRIETHYLAMINE HPLC	1LTR	3,673.80
PB-9426	TRIETHYLAMINE LR-2.5LTR	2.5LIT	1,996.80
PB-9427	TRIETHYLAMINE LR-500ML	500ML	514.80
PB-9428	TRIFLUOROACETIC ACID-100ML	100ML	1482.00
PB-9429	TRIFLUOROACETIC ACID-2.5LTR	2.5LTR	26520.00
PB-9430	TRIFLUOROACETIC ACID-500ML	500ML	5304.00
PB-9431	tri-LITHIUM CITRATE(TETRAHYDRATE) AR-100GM	100GM	1,318.20
PB-9432	tri-LITHIUM CITRATE(TETRAHYDRATE) AR-250GM	250GM	2,698.80
PB-9433	TRIMETHYL ORTHOFORMATE FOR SYNTHESIS 98%	500ML	1,388.40
PB-9434	TRIMETHYL ORTHOFORMATE FOR SYNTHESIS 98%	2.5LTR	5,959.20
PB-9435	TRIMETHYLAMINE FOR SYNTHESIS (SOLUTION 30% IN WATER)	500ML	273.00
PB-9436	TRIMETHYLAMINE FOR SYNTHESIS (SOLUTION 30% IN WATER)	2.5LTR	1279.20
PB-9437	TRIMETHYLAMINE HYDROCHLORIDE FOR SYNTHESIS-100GM	100GM	312.00
PB-9438	TRIMETHYLAMINE HYDROCHLORIDE FOR SYNTHESIS-500GM	500GM	1014.00
PB-9439	TRI-n-OCTYLPHOSPHINE OXIDE AR-10GM	10GM	4524.00

CODE	PRODUCT	PACKING	PRICE
PB-9440	TRI-n-OCTYLPHOSPHINE OXIDE AR-50GM	50GM	18408.00
PB-9441	TRIPHENYL PHOSPHINE FOR SYNTHESIS-100GM	100GM	631.80
PB-9442	TRIPHENYL PHOSPHINE FOR SYNTHESIS-250GM	250GM	1310.40
PB-9443	TRIS BUFFER AR-100GM	100GM	1014.00
PB-9444	TRIS BUFFER AR-500GM	500GM	4524.00
PB-9445	TRIS BUFFER LR-100GM	100GM	889.20
PB-9446	TRIS BUFFER LR-500GM	500GM	4212.00
PB-9447	TRIS-HYDROCHLORIDE AR-100GM	100GM	1123.20
PB-9448	TRIS-HYDROCHLORIDE AR-500GM	500GM	4,914.00
PB-9449	tri-SODIUM CITRATE AR (DIHYDRATE)-500GM	500GM	546.00
PB-9450	tri-SODIUM CITRATE AR (DIHYDRATE)-5KG	5KG	4368.00
PB-9451	tri-SODIUM CITRATE LR (DIHYDRATE)-500GM	500GM	421.20
PB-9452	tri-SODIUM CITRATE LR (DIHYDRATE)-5KG	5KG	3276.00
PB-9453	tri-SODIUM ORTHOPHOSPHATE (DODECAHYDRATE LR)-500GM	500GM	312.00
PB-9454	tri-SODIUM ORTHOPHOSPHATE (DODECAHYDRATE LR)-5KG	5KG	2,574.00
PB-9455	tri-SODIUM ORTHOPHOSPHATE AR (DODECAHYDRATE)-500GM	500GM	390.00
PB-9456	TRITON B FOR SYNTHESIS (Benzyltrimethylammonium hydroxide)-100ML	100ML	1,388.40
PB-9457	TRITON B FOR SYNTHESIS (Benzyltrimethylammonium hydroxide)-500ML	500ML	4,937.40
PB-9458	TRITON X 100	500ML	936.00
PB-9459	TRITON X 100	2.5LTR	4,290.00
15596026P	TRizol™ Reagent	100ML	20,519.20
PB99359	TRizol-T Reagent	100ML	9,360.00
PB41066	TRizol-C Reagent	100ML	9,620.00
PB-9460	TROPEOLIN 0 FOR MICROSCOPY C.I. NO.14270- 100GM	100GM	1,778.40
PB-9461	TROPEOLIN 0 FOR MICROSCOPY C.I. NO.14270- 25GM	25GM	538.20
PB-9462	TROPEOLIN 000 C. I. NO. 15510- 100GM	100GM	897.00
PB-9463	TROPEOLIN 000 C. I. NO. 15510- 25GM	25GM	304.20
PB-9464	TRYPAN BLUE FOR MICROSCOPY-100GM	100GM	4,570.80
PB-9465	TRYPAN BLUE FOR MICROSCOPY-25GM	25GM	1,302.60
PB-9466	TRYPSIN 1: 250	25GM	4212.00
PB-9467	TRYPSIN 1: 250	100GM	13572.00
PB-9468	TRYPSIN U/G 2000	100GM	1528.80
PB-9469	TRYPSIN U/G 2000	500GM	6708.00
PB-9470	TRYPTONE BACTERIOLOGICAL -500GM	500GM	2,215.20
PB-9471	TRYPTOSE BACTERIOLOGICAL-500GM	500GM	2,425.80
PB-9472	TUNGSTEN POWDER 99% -100GM	100GM	2,355.60
PB-9473	TUNGSTEN POWDER 99% -500GM	500GM	11,653.20
PB-9474	TUNGSTIC ACID AR-100GM	100GM	1,209.00
PB-9475	TURK'S SOLUTION-250ML	250ML	156.00
PB-9476	TURPENTINE OIL PURE	500ML	639.60
PB-9477	TURPENTINE OIL PURE	2.5LTR	2,909.40
PB-9478	TWEEN® 20(POLYOXYETHYLENE(20) Sorbitan Monolaurate-500ML	500ML	1,053.00
PB-9479	TWEEN® 80 (POLYOXYETHYLENE(20) Sorbitan Monolaurate-100ML	100ML	280.80
PB-9480	TWEEN® 80 (POLYOXYETHYLENE(20) Sorbitan Monolaurate-2.5LTR	2.5LTR	4,711.20
PB-9481	TWEEN® 80 (POLYOXYETHYLENE(20) Sorbitan Monolaurate-500ML	500ML	1,123.20
PB-9482	TYRAMINE	5GM	2,496.00
PB-9483	TYRAMINE	25GM	11,232.00
PB-9484	TYRAMINE HYDROCHLORIDE FOR SYNTHESIS	5GM	3,049.80
PB-9485	UNIVERSAL INDICATOR PAPERS PH 1-10 (INCLUDING COLOURSCALE)-10BKTS	10BKTS	319.80
PB-9486	UNIVERSAL INDICATOR SOLUTION Ph 4 - 11-125ML	125ML	163.80
PB-9487	UNIVERSAL INDICATOR SOLUTION Ph 4 - 12-500ML	500ML	327.60
PB-9488	URACIL FOR BIOCHEMISTRY-25GM	25GM	608.40
PB-9489	URANYL ACETATE DIHYDRATE FOR MICROSCOPY	5GM	16770.00
PB-9490	URANYL ACETATE DIHYDRATE FOR MICROSCOPY	10GM	32136.00
PB-9491	UREA AR FOR BIOCHEMICAL PURPOSE-500GM	500GM	421.20
PB-9492	UREA LR-500GM	500GM	280.80

CODE	PRODUCT	PACKING	PRICE
PB-9493	UREA LR-5KG	5KG	2340.00
PB-9494	UREA PHOSPHATE LR-500GM	500GM	811.20
PB-9495	URIC ACID AR-100GM	100GM	12948.00
PB-9496	URIC ACID AR-25GM	25GM	3354.00
PB-9497	URIC ACID REAGENT FOLIN / NEWTON-100ML	100ML	249.60
PB-9498	URIDINE 99% for biochemistry-1GM	1GM	343.20
PB-9499	URIDINE 99% for biochemistry-25GM	25GM	5070.00
PB-9500	URIDINE 99% for biochemistry-5GM	5GM	1263.60
PB-9501	VAN GIESON II SOLUTION FOR MICROSCOPY-100ML	100ML	257.40
PB-9502	VANADIUM PENTOXIDE AR -100GM	100GM	1716.00
PB-9503	VANADIUM PENTOXIDE AR -500GM	500GM	8112.00
PB-9504	VANADIUM PENTOXIDE LR -500GM	500GM	6552.00
PB-9505	VANADIUM PENTOXIDE LR-100GM	100GM	1341.60
PB-9506	VANADYL SULPHATE-100GM	100GM	3588.00
PB-9507	VANILLIN AR-100GM	100GM	1,372.80
PB-9508	VANILLIN AR-25GM	25GM	319.80
PB-9509	VANILLIN FOR SYNTHESIS LR-100GM	100GM	858.00
PB-9510	VANILLIN FOR SYNTHESIS LR-500GM	500GM	4,024.80
PB-9511	VICTORIA BLUE FOR MICROSCOPY-100GM	100GM	686.40
PB-9512	VICTORIA BLUE FOR MICROSCOPY-25GM	25GM	218.40
PB-9513	W.B.C. DILUTING FLUID(TRUCK'S)-500ML	500ML	202.80
PB-9514	WANKLYN SOLUTION-500ML	500ML	288.60
PB-9515	WATER DISTILLED	5LTR	592.80
PB-9516	WATER FOR HPLC &SPECTROSCOPY-1LTR	1LTR	553.80
PB-9517	WATER FOR HPLC &SPECTROSCOPY-5LTR	5LTR	2340.00
PB-9518	WRIGHT'S STAIN(for microscopical staining)-100GM	100GM	2808.00
PB-9519	WRIGHT'S STAIN(for microscopical staining)-25GM	25GM	787.80
PB-9520	WRIGHT'S STAINING SOLUTION FOR MICROSCOPY -250ML	250ML	265.20
PB-9521	XANTHAN GUM PURE (FOOD GRADE)	1KG	2605.20
PB-9522	XANTHINE FOR BIOCHEMISTRY-25GM	25GM	3,744.00
PB-9523	XANTHINE FOR BIOCHEMISTRY-5GM	5GM	928.20
PB-9524	XYLENE AR-2.5LTR	2.5LTR	1,872.00
PB-9525	XYLENE AR-500ML	500ML	483.60
PB-9526	XYLENE CYANOL FF (REDOX INDICATOR)-10GM	10GM	3354.00
PB-9527	XYLENE CYANOL FF (REDOX INDICATOR)-25GM	25GM	7488.00
PB-9528	XYLENE LR-2.5LTR	2.5LTR	1,692.60
PB-9529	XYLENE LR-500ML	500ML	390.00
PB-9530	XYLENOL ORANGE AR-10GM	10GM	1326.00
PB-9531	XYLENOL ORANGE AR-5GM	5GM	733.20
PB-9532	YEAST EXTRACT POWDER FOR BACTERIOLOGY-500GM	500GM	1560.00
PB-9533	YEAST EXTRACT POWDER FOR BACTERIOLOGY-5KG	5 KG	14820.00
PB-9534	YTTRIUM NITRATE AR-10GM	10GM	2652.00
PB-9535	YTTRIUM NITRATE AR-25GM	25GM	5928.00
PB-9536	YTTRIUM OXIDE AR-10GM	10GM	1076.40
PB-9537	YTTRIUM OXIDE AR-25GM	25GM	2418.00
PB-9538	ZENKER'S FIXING-100ML	100ML	733.20
PB-9539	ZINC (METAL) GRANULAR-500GM	500GM	1326.00
PB-9540	ZINC ACETATE AR (DIHYDRATE)-500GM	500GM	764.40
PB-9541	ZINC ACETATE LR-500GM	500GM	592.80
PB-9542	ZINC BROMIDE ANHYDROUS LR-500GM	500GM	4056.00
PB-9543	ZINC CARBONATE BASIC-500GM	500GM	967.20
PB-9544	ZINC CHLORIDE (DRY) PURIFIED-1KG	1KG	1,014.00
PB-9545	ZINC CHLORIDE (DRY) PURIFIED-500GM	500GM	577.20
PB-9546	ZINC CHLORIDE DRY AR-500GM	500GM	1,014.00
PB-9547	ZINC DUST AR (325 MESH)-500GM	500GM	1162.20
PB-9548	ZINC DUST LR (325 MESH)-500GM	500GM	967.20

CODE	PRODUCT	PACKING	PRICE
PB-9549	ZINC IODIDE FOR SYNTHESIS-50GM	50GM	2,574.00
PB-9550	ZINC NITRATE LR-500GM	500GM	577.20
PB-9551	ZINC OXIDE (CONFIRMING TO I.P.)-1KG	1KG	1497.60
PB-9552	ZINC OXIDE (CONFIRMING TO I.P.)-500GM	500GM	795.60
PB-9553	ZINC OXIDE (CONFIRMING TO I.P.)-5KG	5KG	7176.00
PB-9554	ZINC OXIDE AR	500GM	936.00
PB-9555	ZINC PHOSPHATE LR	500GM	858.00
PB-9556	ZINC STEARATE PURE-500GM	500GM	538.20
PB-9557	ZINC SULPHATE AR (HEPTAHYDRATE)-500GM	500GM	530.40
PB-9558	ZINC SULPHATE DRIED (MONOHYDRATE)-500GM	500GM	514.80
PB-9559	ZINC SULPHATE PURE (HEPTAHYDRATE)-1KG	1KG	655.20
PB-9560	ZINC SULPHATE PURE (HEPTAHYDRATE)-500GM	500GM	351.00
PB-9561	ZINC SULPHIDE-500GM	500GM	2,574.00
PB-9562	ZINCON AR -5GM	5GM	5616.00
PB-9563	ZINCON AR-1GM	1GM	1,279.20
PB-9564	ZIRCONIUM CARBONATE	100GM	2,012.40
PB-9565	ZIRCONIUM CARBONATE	500GM	8,182.20
PB-9566	ZIRCONIUM DIOXIDE -500GM	500GM	3,049.80
PB-9567	ZIRCONIUM DIOXIDE AR (fine mesh)-500GM	500GM	4,017.00
PB-9568	ZIRCONIUM OXYCHLORIDE AR (FOR FLUORINE DETERMINATION)-100GM	100GM	4,056.00
PB-9569	ZIRCONIUM OXYCHLORIDE-100GM	100GM	561.60
PB-9570	ZIRCONIUM OXYCHLORIDE-500GM	500GM	1,716.00
PB-9571	ZIRCONYL NITRATE-100GM	100GM	3,603.60
PB-9572	ZIRCONYL NITRATE-250GM	250GM	9,430.20
PB-43725	DELPHINIDIN CHLORIDE	1mg	18,780.40
PB-9573	MolBio Reagents-DNA Staining C2H5OH Solution	500ml	2800.00
PB-9574	MolBio Reagents-DNA Staining CH3OH solution	500ml	5800.00



- Megazyme is a global leader in the development, manufacture and supply of analytical reagents, enzymes and assay kits for the food, feed, dairy and wine industries.
- Only company in the world specializing in developing and supplying diagnostic test kits and reagents for the beverage, cereals, dairy, food, feed, fermentation, biofuel and wine industries.
- A globally recognised leader in the development of new testing methods for carbohydrates and enzymes for the cereals and related industries.

Assay Kits >> Enzymes >> Carbohydrates >> Enzyme Substrates >>



Industries Served

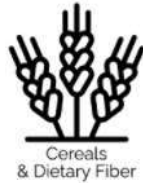

General >>

Feed >>

Cereals and Dietary Fiber >>

Plant Cell Wall and Biofuels >>

Dairy and Infant Formula >>

Enzyme Activity >>

Malting, Brewing and Distilling >>

Wine Kits >>

What we do?

- **Develop** and refine analytical methods used to measure components such as starch, sugars, and enzymes. Cutting-edge research is at the core of Megazyme’s product development, and Megazyme’s methods set new standards in accuracy, reliability and convenience for laboratories around the world.
- **Manufacture** reagents and chemicals used in analytical laboratories, industry and research. Megazyme is noted for the exceptional purity of its enzymes and is the sole world supplier for a number of carbohydrate and enzyme substrate products.

Molecular Biology/Immunology/Tissue Culture ware/ Labware

Molecular Biology Product Group-V

DNA / Protein Marker, Staining Reagent, Agarose Tablet		Packing	Price
DM001-R500	GD 100bp DNA Ladder RTU (Ready-to-Use)	500 µl	₹ 2,940.00
DM001-R500E	GD 100bp DNA Ladder RTU (Ready-to-Use)	500 µl x 10	₹ 24,175.00
DM003-R500	GD 100bp DNA Ladder H3 RTU (Ready-to-Use)	500 µl	₹ 2,940.00
DM003-R500E	GD 100bp DNA Ladder H3 RTU (Ready-to-Use)	500 µl x 10	₹ 24,175.00
DM010-R500	GD 1Kb DNA Ladder RTU (Ready-to-Use)	500 µl	₹ 2,940.00
DM010-R500E	GD 1Kb DNA Ladder RTU (Ready-to-Use)	500 µl x 10	₹ 24,175.00
DM011-R500	GD Kplus DNA Ladder RTU (Ready-to-Use)	500 µl	₹ 4,800.00
DM011-R500E	GD Kplus DNA Ladder RTU (Ready-to-Use)	500 µl x 10	₹ 44,100.00
DM012-R500	GD 50bp DNA Ladder RTU (Ready-to-Use)	500 µl	₹ 4,800.00
DM012-R500E	GD 50bp DNA Ladder RTU (Ready-to-Use)	500 µl x 10	₹ 44,100.00
DM013-R500	GD XLarge DNA Ladder RTU (Ready-to-Use)	500 µl	₹ 4,800.00
DM013-R500E	GD XLarge DNA Ladder RTU (Ready-to-Use)	500 µl x 10	₹ 44,100.00
DM101-0100	GD OneMARK 100 (Ready-to-Use)	600 µl	₹ 3,185.00
DM101-0100E	GD OneMARK 100 (Ready-to-Use)	600 µl x 10	₹ 30,625.00
DM110-0100	GD OneMARK B (Ready-to-Use)	600 µl	₹ 3,185.00
DM110-0100E	GD OneMARK B (Ready-to-Use)	600 µl x 10	₹ 30,625.00
PM001-0500	BLUltra Prestained Protein Ladder	500µl	₹ 8,665.00
PM001-0500E	BLUltra Prestained Protein Ladder	500 µl x 5	₹ 40,000.00
PM005-0500	PiNK Plus Prestained Protein Ladder	500 µl	₹ 8,665.00
PM005-0500E	PiNK Plus Prestained Protein Ladder	500 µl x 5	₹ 40,000.00
PM006-0500	BlueRAY Prestained Protein Ladder	500 µl	₹ 8,665.00
PM006-0500E	BlueRAY Prestained Protein Ladder	500 µl x 5	₹ 40,000.00
PM007-0500	BLUeye Prestained Protein Ladder	500 µl	₹ 9,200.00
PM007-0500E	BLUeye Prestained Protein Ladder	500 µl x 5	₹ 44,825.00
PM008-0500	BLUelf Prestained Protein Ladder	500 µl	₹ 9,800.00
PM008-0500E	BLUelf Prestained Protein Ladder	500 µl x 5	₹ 46,825.00
PM019-0500	BlueAQUA Prestained Protein Ladder	500 µl	₹ 8,665.00
PM019-0500E	BlueAQUA Prestained Protein Ladder	500 µl x 5	₹ 40,000.00
LD001-1000	Novel Juice (DNA Staining Reagent)	1 ml	₹ 3,500.00
LD002-0500	Novel Green (10000X) (DNA Staining Reagent)	500 µl	₹ 16,500.00
LD003-0500	Novel Green Plus (20000X) (DNA Staining Reagent)	500 µl	₹ 20,825.00
NJ001-0010	Nimble Juice (Protein Staining Reagent)	10 ml	₹ 22,050.00
NJ002-0500	Nimble Juice R Type (Protein Staining Reagent)	500 ml	₹ 11,025.00
AGT001-0500	Agarose Tablets	0.5 g x 100	₹ 7,000.00
MB755-0100	Agarose -Molecular Biology Grade	100 g	₹ 9,800.00
MB755-0500	Agarose -Molecular Biology Grade	100 g x5	₹ 39,200.00
MB701-0050	Oligo (dT)20 primer	50 µM	₹ 8,575.00
MB702-0100	Random Hexamers primer	50 µM	₹ 8,575.00
Precast Gel, OnePAGE			
PGV08-10TG	OnePAGE Alpha, 4-20% Tris-Glycin gel, 10well, w buffer, 8x10cm	5 pcs/Box	₹ 12,250.00
PGI08-10TG	OnePAGE Alpha, 4-20% Tris-Glycin gel, 10well, w buffer, 8x10cm	1 pcs	₹ 2,450.00

PGV10-12TG	OnePAGE Sonic, Neutral Gradient (T/G 4-20%), 12well, w/o buffer, 10x10cm	5 pcs/Box	₹ 12,250.00
PGI10-12TG	OnePAGE Beta, Neutral Gradient (T/G 4-20%), 12well, w/o buffer, 10x10cm	1 pcs	₹ 2,450.00
RT & PCR Reagents			
MB201-0100	HotStar PCR SuperMix	100 rxns	₹ 14,700.00
DN025-1000	2.5 mM dNTP Mix	1 ml	₹ 1,225.00
DN0010	10 mM dNTP Mix	1 ml	₹ 3,062.50
DN001025	100 mM dNTP Set	4 x 250 µl	₹ 8,575.00
MB601-0100	GDP-HiFi DNA Polymerase	100 units	₹ 7,350.00
MB101-0500	Taq DNA Polymerase	500 units	₹ 2,205.00
MB300-0050	One-Step RT-PCR System	50 rxns	₹ 24,500.00
MB301-0050	MMLV First-Strand Synthesis Kit	50 rxns	₹ 24,500.00
MB200-0100	PCR SuperMix	100 rxns	₹ 11,025.00
MB203-0100	OnePCR SuperMix, 50 ul for each total RXN volume	100 rxns (2.5 ml)	₹ 5,675.00
MB205-0100	OnePCR HiFi, 50 ul for each total RXN volume	100 rxns (2.5 ml)	₹ 18,025.00
MB206-0100	OnePCR HotStar, 50 ul for each total RXN volume	100 rxns (2.5 ml)	₹ 23,375.00
MB207-0100	OnePCR Plus 50 ul for each total RXN volume	100 rxns (2.5 ml)	₹ 7,410.00
MB303-0050	GScript RTase	50 rxns	₹ 18,375.00
MB305-0050	GScript First-Strand Synthesis Kit	50 rxns	₹ 36,750.00
RI001-2500	RibolN RNase Inhibitor	2500 U	₹ 12,250.00
BK001	BLOOK, LED Transilluminator	Set	₹ 73,500.00
1405021	Mini Darkroom for BLOOK	pcs	₹ 245.00
Realtime PCR Reagents			
QP001-0100	Novel Express qPCR System-ROX I	100 rxns (1 ml)	₹ 9,800.00
QP002-0100	Novel Express qPCR System - ROX II	100 rxns (1 ml)	₹ 9,800.00
QP003-0100	Novel Express qPCR System - ROX Free	100 rxns (1 ml)	₹ 9,800.00
QP005-0100	EvaGreen qPCR System- ROX I, 100 rxns	100 rxns (1 ml)	₹ 9,800.00
QP005-0500	EvaGreen qPCR System- ROX I, 500 rxns	500 rxns (5 ml)	₹ 45,325.00
QP006-0100	EvaGreen qPCR System- ROX II, 100 rxns	100 rxns (1 ml)	₹ 9,800.00
QP006-0500	EvaGreen qPCR System- ROX II, 500 rxns	500 rxns (5 ml)	₹ 45,325.00
QP007-0100	EvaGreen qPCR System- ROX Free, 100 rxns	100 rxns (1 ml)	₹ 9,800.00
QP007-0500	EvaGreen qPCR System- ROX Free, 500 rxns	500 rxns (5 ml)	₹ 45,325.00
Nucleic Acid Purification System			
NA001-0100	GD Reagent (Genomic DNA Isolation Reagent)	100 ml	₹ 12,250.00
NA002-0100	PG Reagent (Plant Genomic DNA Isolation Reagent)	100 ml	₹ 14,700.00
NA003-0100	GR Reagent (Total RNA Isolation Reagent)	100 ml	₹ 12,250.00
NA005-0100	Plasmid miniPREP Kit	100 rxns	₹ 10,412.50
NA006-0100	PCR Clean-Up & Gel Extraction Kit	100 rxns	₹ 10,412.50
NA007-0100	PR Reagent (Plant Total RNA Isolation Reagent)	100 ml	₹ 14,700.00
NA008-0100	Mbead Buffy Coat Genomic DNA Kit	100 rxns	₹ 26,950.00
NA009-0100	Mbead Tissue Genomic DNA Kit	100 rxns	₹ 26,950.00
NA010-0100	Mbead Bacteria Genomic DNA Kit	100 rxns	₹ 26,950.00
NA011-0100	Mbead Virus Genomic Nucleic Acid Kit	100 rxns	₹ 26,950.00
NA012-0100	Mbead Plant Genomic DNA Kit	100 rxns	₹ 26,950.00
NA013-0100	Mbead Blood/Cell Genomic DNA Kit	100 rxns	₹ 26,950.00
NA015-0100	Genomic DNA isolation dual kit	100 rxns	₹ 24,010.00
SC-200436	cDNA Kit 50rxns	50rxns	₹ 15,549.00

SC-200345	RNA Isolation Kit	50rxns	₹ 23,523.00
NA016-0100	Virus Nucleic Acid Isolation Kit	100 rxns	₹ 40,425.00
NA017-0100	Total RNA Isolation Kit	100 rxns	₹ 41,405.00
NA018-0100	Dual Genomic DNA Isolation Kit (Plant)	100 rxns	₹ 28,175.00
NA019-0100	Dual Genomic DNA Isolation Kit(Tissue)	100 rxns	₹ 28,175.00
NA020-0100	Total RNA Isolation Kit (Plant)	100 rxns	₹ 41,405.00
NA021-0100	Total RNA Isolation Kit(Tissue)	100 rxns	₹ 41,405.00
NA022-0100	Genomic DNA Isolation Reagent Kit (Blood/Cultured Cell/Tissue)	100 rxns	₹ 20,335.00
NA023-0100	Genomic DNA Isolation Kit (Blood/Cultured Cell/Fungus)	100 rxns	₹ 20,825.00
NA025-0100	Genomic DNA Isolation Kit (Plant)	100 rxns	₹ 20,825.00
NA026-0100	Genomic DNA Isolation Kit (Tissue)	100 rxns	₹ 22,050.00
NA027-0100	Genomic DNA Isolation Kit (Paraffin-embedded tissue)	100 rxns	₹ 22,050.00
NA205-0020	Plasmid midiPREP Kit	20 rxns	₹ 26,950.00
NA305-0010	Plasmid maxiPREP Kit	10 rxns	₹ 34,300.00

CUSTOM DNA

Custom DNA Synthesis (Desalted DNA Oligos)

Cat No.	Synthesis	Length	Yield	Price (Rs)	Price (Rs)	Plate Service	96 well Plate
	Scale			Tubes	Plates		
SB-981	25 nmole	15-60 bases	3 ODs	30/base	24/base	Loaded with 100% synthesis yield	free
SB-982	100 nmole	10-90 bases	6 ODs	40/base	30/base	Loaded with fixed quantity	free
SB-983	250 nmole	5-100 bases	15 ODs	80/base	70/base	Loaded with fixed quantity, remainder in plates	Inquire
SB-984	1 μmole	5-100 bases	45 ODs	150/base	120/base	Primer mix with remainder in plates	Inquire
SB-985	5 μmole	5-60 bases	225 ODs	650/base	Inquire	Primer mix with fixed quantity and replicate plates	Inquire
SB-986	10 μmole	5-60 bases	450 ODs	1200/base	Inquire		

Duplex Annealing Fee

Cat. No.	Scale	Price (Rs.)	IDT offers many analytical and preparative services for oligos including:
SB-987	100 nmole Duplex	4140	• All oligos QC tested by mass spectrometry
SB-988	250 nmole Duplex	4140	• Standard mixed-base sites
SB-989	1 μmole Duplex	6120	• Customized hand-mix sites
SB-990	100 nmole RNA Duplex	4140	Visit www.idtdna.com for details.
SB-991	250 nmole RNA Duplex	4140	A custom, proprietary LC-MS Electrospray method has been developed to provide accurate mass assessment up to 200 bases.
SB-992	1 μmole RNA Duplex	6120	

SEQUENCING SERVICES

SB-681	Purified plasmid DNA & PCR Product with a read of around 500 - 650 bases	1EA	968
SB-682	Purification of plasmid DNA or PCR Product for sequencing	1EA	545
SB-683	Primer walking of constructs per 1 kb (one strand)	1EA	3872
SB-684	Primer walking of constructs per 1 kb (both strands)	1EA	8954

LABORATORY REAGENTS, FINE CHEMICALS & FILTER PAPERS

FILTER PAPERS

CODE	GRADE REF	TYPE	SIZE IN MM	HSN CODE	G.S.T. %	MRP
101-55	GRADE 1	QUALITATIVE (100 CIRCLES / PACK)	55	48232000	18.00	2610.00
101-70	GRADE 1	QUALITATIVE (100 CIRCLES / PACK)	70	48232000	18.00	2610.00
101-90	GRADE 1	QUALITATIVE (100 CIRCLES / PACK)	90	48232000	18.00	2550.00
101-110	GRADE 1	QUALITATIVE (100 CIRCLES / PACK)	110	48232000	18.00	2660.00
101-125	GRADE 1	QUALITATIVE (100 CIRCLES / PACK)	125	48232000	18.00	2680.00
101-150	GRADE 1	QUALITATIVE (100 CIRCLES / PACK)	150	48232000	18.00	2850.00
101-185	GRADE 1	QUALITATIVE (100 CIRCLES / PACK)	185	48232000	18.00	3260.00
101-240	GRADE 1	QUALITATIVE (100 CIRCLES / PACK)	240	48232000	18.00	4650.00
101-320	GRADE 1	QUALITATIVE (100 CIRCLES / PACK)	320	48232000	18.00	5600.00
101-SH1	GRADE 1 - SHEETS	QUALITATIVE (100 SHEETS / PACK)	460 x 570	48232000	18.00	8900.00
101-SH5	GRADE 1 - SHEETS	QUALITATIVE (500 SHEETS / PACK)	460 x 570	48232000	18.00	27100.00
102-70	GRADE 2	QUALITATIVE (100 CIRCLES / PACK)	70	48232000	18.00	2700.00
102-90	GRADE 2	QUALITATIVE (100 CIRCLES / PACK)	90	48232000	18.00	2730.00
102-110	GRADE 2	QUALITATIVE (100 CIRCLES / PACK)	110	48232000	18.00	2805.00
102-125	GRADE 2	QUALITATIVE (100 CIRCLES / PACK)	125	48232000	18.00	2880.00
102-150	GRADE 2	QUALITATIVE (100 CIRCLES / PACK)	150	48232000	18.00	3325.00
102-SH1	GRADE 2 - SHEETS	QUALITATIVE (100 SHEETS / PACK)	460 x 570	48232000	18.00	13550.00
103-70	GRADE 3	QUALITATIVE (100 CIRCLES / PACK)	70	48232000	18.00	3080.00
103-90	GRADE 3	QUALITATIVE (100 CIRCLES / PACK)	90	48232000	18.00	3150.00
103-110	GRADE 3	QUALITATIVE (100 CIRCLES / PACK)	110	48232000	18.00	3050.00
103-125	GRADE 3	QUALITATIVE (100 CIRCLES / PACK)	125	48232000	18.00	3470.00
103-150	GRADE 3	QUALITATIVE (100 CIRCLES / PACK)	150	48232000	18.00	3550.00
103-SH1	GRADE 3 - SHEETS	QUALITATIVE (100 SHEETS / PACK)	460 x 570	48232000	18.00	23000.00
104-55	GRADE 4	QUALITATIVE (100 CIRCLES / PACK)	55	48232000	18.00	2600.00
104-70	GRADE 4	QUALITATIVE (100 CIRCLES / PACK)	70	48232000	18.00	2600.00
104-90	GRADE 4	QUALITATIVE (100 CIRCLES / PACK)	90	48232000	18.00	2690.00
104-110	GRADE 4	QUALITATIVE (100 CIRCLES / PACK)	110	48232000	18.00	2870.00
104-125	GRADE 4	QUALITATIVE (100 CIRCLES / PACK)	125	48232000	18.00	2940.00
104-150	GRADE 4	QUALITATIVE (100 CIRCLES / PACK)	150	48232000	18.00	3290.00
104-185	GRADE 4	QUALITATIVE (100 CIRCLES / PACK)	185	48232000	18.00	3900.00
104-240	GRADE 4	QUALITATIVE (100 CIRCLES / PACK)	240	48232000	18.00	5500.00
104-320	GRADE 4	QUALITATIVE (100 CIRCLES / PACK)	320	48232000	18.00	7700.00
104-SH1	GRADE 4 - SHEETS	QUALITATIVE (100 SHEETS / PACK)	460x570	48232000	18.00	15900.00
440-12.7	GRADE 40	QUANTITATIVE ASHLESS (100 CIRCLES / PACK)	12.7	48232000	18.00	3250.00
440-70	GRADE 40	QUANTITATIVE ASHLESS (100 CIRCLES / PACK)	70	48232000	18.00	3200.00
440-90	GRADE 40	QUANTITATIVE ASHLESS (100 CIRCLES / PACK)	90	48232000	18.00	3580.00
440-110	GRADE 40	QUANTITATIVE ASHLESS (100 CIRCLES / PACK)	110	48232000	18.00	3900.00
440-125	GRADE 40	QUANTITATIVE ASHLESS (100 CIRCLES / PACK)	125	48232000	18.00	4300.00
440-150	GRADE 40	QUANTITATIVE ASHLESS (100 CIRCLES / PACK)	150	48232000	18.00	5100.00
440-185	GRADE 40	QUANTITATIVE ASHLESS (100 CIRCLES / PACK)	185	48232000	18.00	7100.00
440-240	GRADE 40	QUANTITATIVE ASHLESS (100 CIRCLES / PACK)	240	48232000	18.00	12225.00
440-SH1	GRADE 40	QUANTITATIVE ASHLESS (100 CIRCLES / PACK)	460 x 570	48232000	18.00	33300.00
441-70	GRADE 41	QUANTITATIVE ASHLESS (100 CIRCLES / PACK)	70	48232000	18.00	3200.00

CODE	GRADE REF	TYPE	SIZE IN MM	HSN CODE	G.S.T. %	MRP
441-90	GRADE 41	QUANTITATIVE ASHLESS (100 CIRCLES / PACK)	90	48232000	18.00	3640.00
441-110	GRADE 41	QUANTITATIVE ASHLESS (100 CIRCLES / PACK)	110	48232000	18.00	4140.00
441-125	GRADE 41	QUANTITATIVE ASHLESS (100 CIRCLES / PACK)	125	48232000	18.00	4420.00
441-150	GRADE 41	QUANTITATIVE ASHLESS (100 CIRCLES / PACK)	150	48232000	18.00	5200.00
441-185	GRADE 41	QUANTITATIVE ASHLESS (100 CIRCLES / PACK)	185	48232000	18.00	6900.00
441-SH1	GRADE 41	QUANTITATIVE ASHLESS (100 CIRCLES / PACK)	460 x 570	48232000	18.00	31600.00
442-55	GRADE 42	QUANTITATIVE ASHLESS (100 CIRCLES / PACK)	55	48232000	18.00	3060.00
442-70	GRADE 42	QUANTITATIVE ASHLESS (100 CIRCLES / PACK)	70	48232000	18.00	3220.00
442-90	GRADE 42	QUANTITATIVE ASHLESS (100 CIRCLES / PACK)	90	48232000	18.00	3570.00
442-110	GRADE 42	QUANTITATIVE ASHLESS (100 CIRCLES / PACK)	110	48232000	18.00	3970.00
442-125	GRADE 42	QUANTITATIVE ASHLESS (100 CIRCLES / PACK)	125	48232000	18.00	4320.00
442-150	GRADE 42	QUANTITATIVE ASHLESS (100 CIRCLES / PACK)	150	48232000	18.00	5070.00
442-185	GRADE 42	QUANTITATIVE ASHLESS (100 CIRCLES / PACK)	185	48232000	18.00	6900.00
442-240	GRADE 42	QUANTITATIVE ASHLESS (100 CIRCLES / PACK)	240	48232000	18.00	9950.00
442-320	GRADE 42	QUANTITATIVE ASHLESS (100 CIRCLES / PACK)	320	48232000	18.00	16400.00
442-SH1	GRADE 42	QUANTITATIVE ASHLESS (100 CIRCLES / PACK)	460 x 570	48232000	18.00	32600.00
443-90	GRADE 43	QUANTITATIVE ASHLESS (100 CIRCLES / PACK)	90	48232000	18.00	4050.00
443-110	GRADE 43	QUANTITATIVE ASHLESS (100 CIRCLES / PACK)	110	48232000	18.00	4780.00
443-125	GRADE 43	QUANTITATIVE ASHLESS (100 CIRCLES / PACK)	125	48232000	18.00	4500.00
443-150	GRADE 43	QUANTITATIVE ASHLESS (100 CIRCLES / PACK)	150	48232000	18.00	6450.00
443-SH1	GRADE 43	QUANTITATIVE ASHLESS (100 CIRCLES / PACK)	460 x 570	48232000	18.00	37100.00

Molecular Biology-SciBio

CODE	DESCRIPTION	PRICE ₹
SC-KK2101	SCIBIO-KAPA HiFi DNA Polymerase with dNTPs 100U	11053
SC-KK2102	SCIBIO-KAPA HiFi DNA Polymerase with dNTPs 250U	27631
SC-KK2501	SCIBIO-KAPA HiFi HotStart DNA Polymerase with dNTPs 100U	12631
SC-KK2502	SCIBIO-KAPA HiFi HotStart DNA Polymerase with dNTPs 250U	31579
SC-KK2601	SCIBIO-KAPA HiFi HotStart ReadyMix 100rxn	8425
SC-KK2602	SCIBIO-KAPA HiFi HotStart ReadyMix 500rxn	37895
SC-KK2801	SCIBIO-KAPA HiFi HotStart Uracil+ ReadyMix (1 x 1.25 mL) 50rxn	37895
SC-KK2802	SCIBIO-KAPA HiFi HotStart Uracil+ ReadyMix (1 x 6.25 mL) 250rxn	151579
SC-KK3006	SCIBIO-KAPA Long Range DNA Polymerase with dNTPs 100U	7579
SC-KK3005	SCIBIO-KAPA Long Range DNA Polymerase with dNTPs 250U	18947
SC-KK3009	SCIBIO-KAPA Taq EXtra with dNTPs 250U	11369
SC-KK3501	SCIBIO-KAPA Long Range HotStart DNA Polymerase with dNTPs 100U	10105
SC-KK3502	SCIBIO-KAPA Long Range HotStart DNA Polymerase with dNTPs 250U	24000
SC-KK3503	SCIBIO-KAPA Long Range HotStart DNA Polymerase with dNTPs 500U	44210
SC-KK3606	SCIBIO-KAPATaq EXtra HotStart ReadyMix with dye (200 x 25 µL rxns) 200rxn	7579
SC-KK5023	SCIBIO-KAPA2G Robust DNA Polymerase 100U	6176
SC-KK5024	SCIBIO-KAPA2G Robust DNA Polymerase 100U	14040
SC-KK5004	SCIBIO-KAPA2G Robust DNA Polymerase with dNTPs 100U	7579
SC-KK5005	SCIBIO-KAPA2G Robust DNA Polymerase with dNTPs 250U	17545
SC-KK5522	SCIBIO-KAPA2G Robust HotStart DNA Polymerase 100U	8842
SC-KK5515	SCIBIO-KAPA2G Robust HotStart DNA Polymerase 250U	18947

Molecular Biology-SciBio		
CODE	DESCRIPTION	PRICE ₹
SC-KK5517	SCIBIO-KAPA2G Robust HotStart DNA Polymerase 500U	34105
SC-KK5532	SCIBIO-KAPA2G Robust HotStart DNA Polymerase with dNTPs 100U	10105
SC-KK5516	SCIBIO-KAPA2G Robust HotStart DNA Polymerase with dNTPs 250U	22105
SC-KK5518	SCIBIO-KAPA2G Robust HotStart DNA Polymerase with dNTPs 500U	37895
SC-KK5701	SCIBIO-KAPA2G Robust HotStart ReadyMix 100rxn	7895
SC-KK5702	SCIBIO-KAPA2G Robust HotStart ReadyMix 500rxn	39474
SC-KK5704	SCIBIO-KAPA2G Robust HotStart ReadyMix with dye (100 x 25 µL reactions) 100rxn	9474
SC-KK5705	SCIBIO-KAPA2G Robust HotStart ReadyMix with dye (500 x 25 µL reactions) 500rxn	41053
SC-KK5020	SCIBIO-KAPA2G Fast DNA Polymerase 100U	4547
SC-KK5008	SCIBIO-KAPA2G Fast DNA Polymerase with dNTPs 100U	5558
SC-KK5101	SCIBIO-KAPA2G Fast ReadyMix with dye (100 x 25 µL reactions) 100rxn	3158
SC-KK5102	SCIBIO-KAPA2G Fast ReadyMix with dye (500 x 25 µL reactions) 500rxn	12631
SC-KK5523	SCIBIO-KAPA2G Fast HotStart DNA Polymerase 100U	8842
SC-KK5503	SCIBIO-KAPA2G Fast HotStart DNA Polymerase 250U	19736
SC-KK5501	SCIBIO-KAPA2G Fast HotStart DNA Polymerase 500U	28421
SC-KK5530	SCIBIO-KAPA2G Fast HotStart DNA Polymerase with dNTPs 100U	8084
SC-KK5502	SCIBIO-KAPA2G Fast HotStart DNA Polymerase with dNTPs 250U	29476
SC-KK5500	SCIBIO-KAPA2G Fast HotStart DNA Polymerase with dNTPs 500U	52636
SC-KK5513	SCIBIO-KAPA2G Fast HotStart DNA Polymerase - Mg ²⁺ free buffer 250U	13162
SC-KK5511	SCIBIO-KAPA2G Fast HotStart DNA Polymerase - Mg ²⁺ free buffer 500U	18947
SC-KK5512	SCIBIO-KAPA2G Fast HotStart DNA Polymerase with dNTPs - Mg ²⁺ free buffer 250U	31579
SC-KK5603	SCIBIO-KAPA2G Fast HotStart ReadyMix (100 x 25 µL rxns) 100rxn	4736
SC-KK5601	SCIBIO-KAPA2G Fast HotStart ReadyMix (500 x 25 µL rxns) 500rxn	23684
SC-KK5608	SCIBIO-KAPA2G Fast HotStart ReadyMix with dye (100 x 25 µL reactions) 100rxn	6316
SC-KK5609	SCIBIO-KAPA2G Fast HotStart ReadyMix with dye (500 x 25 µL reactions) 500rxn	28781
SC-KK5801	SCIBIO-KAPA2G Fast Multiplex PCR Kit (100 x 25 µL rxn) 100rxn	9474
SC-KK5802	SCIBIO-KAPA2G Fast Multiplex PCR Kit (500 x 25 µL rxn) 500rxn	37895
SC-KK7002	SCIBIO-KAPA Blood PCR Mix A (500 x 25 µL rxns) 500rxn	31579
SC-KK7003	SCIBIO-KAPA Blood PCR Mix B (500 x 25 µL rxns) 500rxn	31579
SC-KK7004	SCIBIO-KAPA Blood PCR Mix A (1000 x 25 µL rxns) 1000rxn	58951
SC-KK7005	SCIBIO-KAPA Blood PCR Mix B (1000 x 25 µL rxns) 1000rxn	58951
SC-KK7100	SCIBIO-KAPA Express Extract 50rxn	7579
SC-KK7101	SCIBIO-KAPA Express Extract 100rxn	12631
SC-KK7102	SCIBIO-KAPA Express Extract 250rxn	37895
SC-KK7103	SCIBIO-KAPA Express Extract 500rxn	66316
SC-KK7151	SCIBIO-KAPA Express Extract (100 rxn) and SCIBIO-KAPA2G Robust HotStart ReadyMix (100 rxn) combo	18947
SC-KK7152	SCIBIO-KAPA Express Extract (500 rxn) and SCIBIO-KAPA2G Robust HotStart ReadyMix (500 rxn) combo	94736
SC-KK7251	SCIBIO-KAPA3G Plant PCR Kit (250 x 50 µL reactions) 250U	29609
SC-KK7252	SCIBIO-KAPA3G Plant PCR Kit (500 x 50 µL reactions) 500U	53293

Molecular Biology-SciBio		
CODE	DESCRIPTION	PRICE ₹
SC-KK7301	SCIBIO-KAPA Mouse Genotyping Kit(100 x 25 µL rxns) 100rxn	15790
SC-KK7302	SCIBIO-KAPA Mouse Genotyping Kit (500 x 25 µL reactions) 500rxn	31579
SC-KK7351	SCIBIO-KAPA Mouse Genotyping Kit (HotStart)(100 x 25 µL rxns) 100rxn	17899
SC-KK7352	SCIBIO-KAPA Mouse Genotyping Kit HotStart (500 x 25 µL reactions) 500rxn	39474
SC-KK5621	SCIBIO-KAPA2G Fast HotStart Genotyping PCR Mix (500 x 25 µL reactions) 500rxns	29609
SC-KK1015	SCIBIO-KAPA Taq DNA Polymerase 500U	2053
SC-KK1006	SCIBIO-KAPA Taq ReadyMix (250 x 50 µL rxns) 250rxns	9474
SC-KK1020	SCIBIO-KAPA Taq DNA Polymerase with dye 250U	2369
SC-KK1022	SCIBIO-KAPA Taq DNA Polymerase with dye 500U	4736
SC-KK1021	SCIBIO-KAPA Taq DNA Polymerase with dNTPs and dye 250U	10529
SC-KK1023	SCIBIO-KAPA Taq DNA Polymerase with dNTPs and dye 500U	23867
SC-KK1024	SCIBIO-KAPA Taq ReadyMix with dye (250 x 50 µL rxns) 250rxn	9474
SC-KK1508	SCIBIO-KAPA Taq HotStart DNA Polymerase 250U	4736
SC-KK1510	SCIBIO-KAPA Taq HotStart DNA Polymerase 500U	8842
SC-KK1509	SCIBIO-KAPA Taq HotStart DNA Polymerase with dNTPs 250U	19478
SC-KK1511	SCIBIO-KAPA Taq HotStart DNA Polymerase with dNTPs 500U	30790
SC-KK1007	SCIBIO-KAPA dNTP Kit 4 x 100mM	10529
SC-KK1017	SCIBIO-KAPA 10 mM dNTP Mix 500 ul	3790
SC-KK6010	SCIBIO-KAPA T4 DNA Ligase Kit (250 U) 250U	9455
SC-KK6110	SCIBIO-KAPA Rapid Ligation System (50 reactions) 50rxn	20729
SC-KK6111	SCIBIO-KAPA Rapid Ligation System (150 reactions) 150rxn	51536
SC-KK6302	SCIBIO-KAPA Universal DNA Ladder (100 ng/µL 1 x 1 mL) 200lanes	5899
SC-KK6303	SCIBIO-KAPA Universal DNA Ladder (100 ng/µL 5 x 1 mL) 1000lanes	23684
SC-KK6304	SCIBIO-KAPA Express DNA Ladder (50 ng/µL 1 x 1 mL) 200 lanes	5899
SC-KK6305	SCIBIO-KAPA Express DNA Ladder (50 ng/µL 5 x 1 mL) 1000 lanes	23684
SC-KK4600	SCIBIO-KAPA SYBR® FAST Universal 2X qPCR Master Mix 1ml	4264
SC-KK4601	SCIBIO-KAPA SYBR® FAST Universal 2X qPCR Master Mix 5 ml	21316
SC-KK4602	SCIBIO-KAPA SYBR® FAST Universal 2X qPCR Master Mix 10ml	42631
SC-KK4603	SCIBIO-KAPA SYBR® FAST ABI Prism® 2X qPCR Master Mix 1ml	4264
SC-KK4604	SCIBIO-KAPA SYBR® FAST ABI Prism® 2X qPCR Master Mix 5ml	21316
SC-KK4605	SCIBIO-KAPA SYBR® FAST ABI Prism® 2X qPCR Master Mix 10ml	42631
SC-KK4606	SCIBIO-KAPA SYBR® FAST Bio-Rad iCycler 2X qPCR Master Mix 1ml	4264
SC-KK4607	SCIBIO-KAPA SYBR® FAST Bio-Rad iCycler 2X qPCR Master Mix 5ml	21316
SC-KK4608	SCIBIO-KAPA SYBR® FAST Bio-Rad iCycler 2X qPCR Master Mix 10ml	42631
SC-KK4609	SCIBIO-KAPA SYBR® FAST Roche LightCycler® 480 2X qPCR Master Mix 1ml	4264
SC-KK4610	SCIBIO-KAPA SYBR® FAST Roche LightCycler® 480 2X qPCR Master Mix 5ml	21316
SC-KK4611	SCIBIO-KAPA SYBR® FAST Roche LightCycler® 480 2X qPCR Master Mix 10ml	42631
SC-KK4619	SCIBIO-KAPA SYBR® FAST ROX Low 2X qPCR Master Mix (1 x 1 mL) 1ml	4264
SC-KK4620	SCIBIO-KAPA SYBR® FAST ROX Low 2X qPCR Master Mix (1 x 5 mL) 5ml	21316
SC-KK4621	SCIBIO-KAPA SYBR® FAST ROX Low 2X qPCR Master Mix (2 x 5 mL) 10ml	42631

Molecular Biology-SciBio		
CODE	DESCRIPTION	PRICE ₹
SC-KK4650	SCIBIO-KAPA SYBR FAST One-Step qRT-PCR Kit Universal (100 x 20 µl reactions)	16674
SC-KK4660	SCIBIO-KAPA SYBR FAST One-Step qRT-PCR Kit ABI Prism™ (100 x 20 µl reactions)	16674
SC-KK4670	SCIBIO-KAPA SYBR FAST One-Step qRT-PCR Kit Bio-Rad iCycler™ (100 x 20 µl reactions)	16674
SC-KK4680	SCIBIO-KAPA SYBR FAST One-Step qRT-PCR Kit Roche LightCycler® 480 (100 x 20 µl reactions)	16674
SC-KK4701	SCIBIO-KAPA PROBE FAST Universal 2X qPCR Master Mix 1 ml	6316
SC-KK4702	SCIBIO-KAPA PROBE FAST Universal 2X qPCR Master Mix 5ml	31579
SC-KK4705	SCIBIO-KAPA PROBE FAST ABI Prism® 2X qPCR Master Mix 1 ml	6316
SC-KK4706	SCIBIO-KAPA PROBE FAST ABI Prism® 2X qPCR Master Mix 5ml	31579
SC-KK4709	SCIBIO-KAPA PROBE FAST Bio-Rad iCycler 2X qPCR Master Mix 1 ml	6316
SC-KK4710	SCIBIO-KAPA PROBE FAST Bio-Rad iCycler 2X qPCR Master Mix 5ml	31579
SC-KK4716	SCIBIO-KAPA PROBE FAST ROX Low 2X qPCR Master Mix (1 mL)	6316
SC-KK4717	SCIBIO-KAPA PROBE FAST ROX Low 2X qPCR Master Mix (5 mL) 5ml	31579
SC-KK4201	SCIBIO-KAPA HRM FAST PCR Kit (1 mL)	11369
SC-KK4202	SCIBIO-KAPA HRM FAST PCR Kit (5 mL) 5ml	44210
SC-KK8200	SCIBIO-KAPA Library Preparation Kits with Standard PCR Library Amplification/Illumina series (10 libraries) 10 rxn	42631
SC-KK8201	SCIBIO-KAPA Library Preparation Kits with Standard PCR Library Amplification/Illumina series (50 libraries) 50rxn	167116
SC-KK8220	SCIBIO-KAPA Library Preparation Kits with Real-Time PCR Library Amplification/Illumina series (10 libraries) 10 rxn	64610
SC-KK8221	SCIBIO-KAPA Library Preparation Kits with Real-Time PCR Library Amplification/Illumina series (50 libraries) 50rxn	272842
SC-KK8230	SCIBIO-KAPA Low Throughput Library Preparation Kit with SPRI solution and Standard PCR Library Amplification/Illumina series (10 libraries) 10 rxn	47747
SC-KK8231	SCIBIO-KAPA Low Throughput Library Preparation Kit with SPRI solution and no PCR Library Amplification/Illumina series (10 libraries) 10 rxn	42631
SC-KK8232	SCIBIO-KAPA Low Throughput Library Preparation Kit with SPRI solution and Standard PCR Library Amplification/Illumina series (50 libraries) 50rxn	221053
SC-KK8233	SCIBIO-KAPA Low Throughput Library Preparation Kit with SPRI solution and no PCR Library Amplification/Illumina series (50 libraries) 50rxn	198947
SC-KK8234	SCIBIO-KAPA High Throughput Library Preparation Kit with SPRI solution and Standard PCR Library Amplification/Illumina series (96 libraries) 96rxn	473684
SC-KK8235	SCIBIO-KAPA High Throughput Library Preparation Kit with SPRI solution and no PCR Library Amplification/Illumina series (96 libraries) 96rxn	505264
SC-KK8240	SCIBIO-KAPA Library Preparation Kits with no PCR Library Amplification/Illumina series (10 libraries) 10 rxn	37895
SC-KK8241	SCIBIO-KAPA Library Preparation Kits with no PCR Library Amplification/Illumina series (50 libraries) 50rxn	151579
SC-KK8300	SCIBIO-KAPA Library Preparation Kits with Standard PCR Library Amplification/Ion Torrent series (8 libraries) 8rxn	31831
SC-KK8301	SCIBIO-KAPA Library Preparation Kits with Standard PCR Library Amplification/Ion Torrent series (48 libraries) 48rxn	151579
SC-KK8310	SCIBIO-KAPA Library Preparation Kits with no Library Amplification/Ion Torrent series (8 libraries) 8 rxn	28800
SC-KK8311	SCIBIO-KAPA Library Preparation Kits with no PCR Library Amplification/Ion Torrent series (48 libraries) 48RXN	156884
SC-KK8330	SCIBIO-KAPA non-barcoded Adapter Kits/Ion Torrent series (8 libraries) 8RXN	15158

Molecular Biology-SciBio		
CODE	DESCRIPTION	PRICE ₹
SC-KK8331	SCIBIO-KAPA Barcoded Adapter Kits, with Barcodes 1 - 8/Ion Torrent series (48 libraries) 48 RXN	94736
SC-KK8332	SCIBIO-KAPA Barcoded Adapter Kits, with Barcodes 9 - 16/Ion Torrent series (48 libraries) 48RXN	94736
SC-KK8333	SCIBIO-KAPA Barcoded Adapter Kits, with Barcodes 17 - 24/Ion Torrent series (48 libraries) 48 RXN	94736
SC-KK2611	SCIBIO-KAPA HiFi Library Amplification Kit (50 x 50 µL reactions) 50RXN	8425
SC-KK2612	SCIBIO-KAPA HiFi Library Amplification Kit (250 x 50 µL reactions) 250 RXN	42107
SC-KK2701	SCIBIO-KAPA Real-Time Library Amplification Kit (50 x 50 µL reactions) 50 RXN	27284
SC-KK2702	SCIBIO-KAPA Real-Time Library Amplification Kit (250 x 50 µL reactions) 250 RXN	113684
SC-KK4800	DNA Quantification Standards and Primer Premix Kit - Roche 454 FLX each	61579
SC-KK4801	DNA Quantification Primer Premix - Roche 454 FLX each	30790
SC-KK4802	DNA Quantification Standards and Primer Premix Kit - Roche 454 Titanium Each	61579
SC-KK4803	KK4803 DNA Quantification Primer Premix - Roche 454 Titanium Each	30790
SC-KK4804	DNA Quantification Standards and Primer Premix Kit - Illumina (old Primer Premix) Each	61579
SC-KK4805	KK4805 Old DNA Quantification Primer Premix - Illumina Each	30790
SC-KK4806	KK4806 DNA Quantification Standards and Primer Premix Kit - ABI SOLiD Each	61579
SC-KK4807	KK4807 DNA Quantification Primer Premix - ABI SOLiD Each	30790
SC-KK4808	DNA Quantification Standards and Primer Premix Kit - Illumina (new PrimerPremix) Each	61579
SC-KK4809	Illumina Revised Primer Premix Each	30790
SC-KK4900	Library Quantification DNA Standards only - 454 FLX/Lib-A Each	35526
SC-KK4920	Library Quantification Primer Premix and qPCR MasterMix only - 454 FLX (Lib- A)/Universal Each	71053
SC-KK4930	Library Quantification Primer Premix and qPCR MasterMix only - 454 FLX (Lib- A)/ABI Prism® Each	71053
SC-KK4940	Library Quantification Primer Premix and qPCR MasterMix only - 454 FLX (Lib- A)/Bio-Rad iCycler™ Each	71053
SC-KK4950	Library Quantification Primer Premix and qPCR MasterMix only - 454 FLX (Lib- A)/LightCycler® 480 Each	71053
SC-KK4970	Library Quantification Primer Premix and qPCR MasterMix only - 454 FLX (Lib- A)/ROX Low Each	71053
SC-KK4901	Library Quantification DNA Standards only - 454 Titanium/Lib-L Each	35476
SC-KK4921	Library Quantification Primer Premix and qPCR MasterMix only - 454 Titanium (Lib- L)/Universal Each	71053
SC-KK4931	Library Quantification Primer Premix and qPCR MasterMix only - 454 Titanium (Lib-L)/ABI Prism® Each	71053
SC-KK4941	Library Quantification Primer Premix and qPCR MasterMix only - 454 Titanium (Lib-L)/Bio-Rad iCycler™ Each	71053
SC-KK4951	Library Quantification Primer Premix and qPCR MasterMix only - 454 Titanium (Lib- L)/LightCycler® 480 Each	71053
SC-KK4971	Library Quantification Primer Premix and qPCR MasterMix only - 454 Titanium (Lib-L)/ROX Low Each	71053
SC-KK4902	Library Quantification DNA Standards only - SOLiD Each	35526
SC-KK4922	Library Quantification Primer Premix and qPCR MasterMix only - SOLiD/Universal Each	71053
SC-KK4932	Library Quantification Primer Premix and qPCR MasterMix only - SOLiD/ABI Prism® Each	71053
SC-KK4942	Library Quantification Primer Premix and qPCR MasterMix only - SOLiD/Bio-Rad iCycler™ Each	71053

Molecular Biology-SciBio		
CODE	DESCRIPTION	PRICE ₹
SC-KK4952	Library Quantification Primer Premix and qPCR MasterMix only -SOLiD/LightCycler® 480 Each	71053
SC-KK4972	Library Quantification Primer Premix and qPCR MasterMix only - SOLiD/ROX Low Each	71053
SC-KK4903	Library Quantification DNA Standards only - Illumina Each	35526
SC-KK4923	Library Quantification Primer Premix and qPCR MasterMix only - Illumina/Universal Each	71053
SC-KK4933	Library Quantification Primer Premix and qPCR MasterMix only - Illumina/ABI Prism® Each	71053
SC-KK4943	Library Quantification Primer Premix and qPCR MasterMix only - Illumina/Bio- Rad iCycler™ Each	71053
SC-KK4953	Library Quantification Primer Premix and qPCR MasterMix only - Illumina/LightCycler® 480 Each	71053
SC-KK4973	Library Quantification Primer Premix and qPCR MasterMix only - Illumina/ROX Low Each	71053
SC-KK4904	Library Quantification DNA Standards only - Ion Torrent Each	35526
SC-KK4924	Library Quantification Primer Premix and qPCR MasterMix only - Ion Torrent/Universal Each	71053
SC-KK4934	Library Quantification Primer Premix and qPCR MasterMix only - Ion Torrent/ABI Prism® Each	71053
SC-KK4944	Library Quantification Primer Premix and qPCR MasterMix only - Ion Torrent/Bio-Rad iCycler™ Each	71053
SC-KK4954	Library Quantification Primer Premix and qPCR MasterMix only - Ion Torrent/LightCycler® 480 Each	71053
SC-KK4974	Library Quantification Primer Premix and qPCR MasterMix only - Ion Torrent/ROX Low Each	71053
SC-KK4820	Library Quantification Kit - 454 FLX (Lib-A)/Universal Each	90790
SC-KK4821	Library Quantification Kit - 454 Titanium (Lib-L)/Universal Each	90790
SC-KK4822	Library Quantification Kit - Illumina -SCIBIO-KAPA SYBR FAST Universal(old Primer Premix) Each	90790
SC-KK4823	Library Quantification Kit - SOLiD/Universal Each	90790
SC-KK4824	Library Quantification Kit - Illumina/Universal Each	90790
SC-KK4827	Library Quantification Kit - Ion Torrent/Universal Each	90790
SC-KK4830	Library Quantification Kit - 454 FLX (Lib-A)/ABI Prism® Each	90790
SC-KK4831	Library Quantification Kit - 454 Titanium (Lib-L)/ABI Prism® Each	90790
SC-KK4832	Library Quantification Kit - Illumina -SCIBIO-KAPA SYBR FAST ABI Prism(old Primer Premix) Each	90790
SC-KK4833	Library Quantification Kit - SOLiD/ABI Prism® Each	90790
SC-KK4835	Library Quantification Kit - Illumina/ABI Prism®Each	90790
SC-KK4836	Ion Torrent- SYBR Fast ABI Prism Each	90790
SC-KK4838	Library Quantification Kit - Ion Torrent/ABI Prism® Each	90790
SC-KK4840	Library Quantification Kit - 454 FLX (Lib-A)/Bio-Rad iCycler™ Each	90790
SC-KK4841	Library Quantification Kit - 454 Titanium (Lib-L)/Bio-Rad iCycler™ Each	90790
SC-KK4844	Library Quantification Kit - Illumina/Bio-Rad iCycler™ Each	90790
SC-KK4842	Library Quantification Kit - Illumina -SCIBIO-KAPA SYBR FAST Bio-Rad iCycler(old Primer Premix) Each	90790
SC-KK4843	Library Quantification Kit - SOLiD/Bio-Rad iCycler™ Each	90790
SC-KK4846	Ion Torrent - SYBR Fast Bio-Rad iCycler Each	90790
SC-KK4847	Library Quantification Kit - Ion Torrent/Bio-Rad iCycler™ Each	90790
SC-KK4850	Library Quantification Kit - 454 FLX (Lib-A)/LightCycler® 480 Each	90790
SC-KK4851	Library Quantification Kit - 454 Titanium (Lib-L)/LightCycler® 480 Each	90790

Molecular Biology-SciBio		
CODE	DESCRIPTION	PRICE ₹
SC-KK4852	Library Quantification Kit - Illumina -SCIBIO-KAPA SYBR FAST Roche LightCycler 480(old Primer Premix)	90790
SC-KK4853	Library Quantification Kit - SOLiD/LightCycler® 480	90790
SC-KK4854	Library Quantification Kit - Illumina/LightCycler® 480	90790
SC-KK4857	Library Quantification Kit - Ion Torrent/LightCycler® 480	90790
SC-KK4870	Library Quantification Kit - 454 FLX (Lib-A)/ROX Low	90790
SC-KK4871	Library Quantification Kit - 454 Titanium (Lib-L)/ROX Low	90790
SC-KK4872	Library Quantification Kit - SOLiD/ROX Low	90790
SC-KK4873	Library Quantification Kit - Illumina/ROX Low	90790
SC-KK4874	Library Quantification Kit - Ion Torrent/ROX Low	90790
SC-KK4960	Human Genomic DNA Quantification and QC Kit - Universal 300 x 20 µl rxns	121055
SC-KK4961	Human Genomic DNA Quantification and QC Kit - ABI Prism®300 x 20 µl rxns	121055
SC-KK4962	Human Genomic DNA Quantification and QC Kit - Bio-Rad iCycler™300 x 20 µl rxn	121055
SC-KK4963	Human Genomic DNA Quantification and QC Kit optimized for Roche LightCycler® 480 300 x 20 µl rxns	121055
SC-KK4964	Human Genomic DNA Quantification and QC - DNA Standards only 5 x 300 µl	84215
SC-KK4965	Human Genomic DNA Quantification and QC - 41 bp Primer Premix only 200 µl	21056
SC-KK4966	Human Genomic DNA Quantification and QC - 129 bp Primer Premix only 200 µl	21056
SC-KK4967	Human Genomic DNA Quantification and QC - 305 bp Primer Premix only 200 µl	21056
SC-KK4969	Human Genomic DNA Quantification and QC Kit - ROX Low Each	121055
SC-KK8400	SCIBIO-KAPA Stranded RNA-Seq Library Preparation Kit for Illumina (24 rxns)	227369
SC-KK8401	SCIBIO-KAPA Stranded RNA-Seq Library Preparation Kit for Illumina (96 rxns)	707369
SC-KK8420	SCIBIO-KAPA Stranded mRNA-Seq Library Preparation Kit for Illumina (24 rxns)	256566
SC-KK8421	SCIBIO-KAPA Stranded mRNA-Seq Library Preparation Kit for Illumina (96 rxns)	782040
SC-KK8500	SCIBIO-KAPA Hyper Prep Kit for Illumina (8 rxns)	57284
SC-KK8501	SCIBIO-KAPA Hyper Prep Kit for Illumina, no amplification (8 rxns)	55579
SC-KK8502	SCIBIO-KAPA Hyper Prep Kit for Illumina (24 rxns)	151579
SC-KK8503	SCIBIO-KAPA Hyper Prep Kit for Illumina, no amplification (24 rxns)	146526
SC-KK8504	SCIBIO-KAPA Hyper Prep Kit for Illumina (96 rxns)	525474
SC-KK8505	SCIBIO-KAPA Hyper Prep Kit for Illumina, no amplification (96 rxns)	505264
SC-KK8510	SCIBIO-KAPA Hyper Plus kits for Illumina with Lib. Amplification (8rxn)	67390
SC-KK8511	SCIBIO-KAPA Hyper Plus kits for Illumina, no Amplification (8rxn)	65684
SC-KK8512	SCIBIO-KAPA Hyper Plus kits for Illumina with Lib. Amplification (24rxn)	181895
SC-KK8513	SCIBIO-KAPA Hyper Plus kits for Illumina, no Amplification (24rxn)	176842
SC-KK8514	SCIBIO-KAPA Hyper Plus kits for Illumina with Lib. Amplification (96rxn)	646736
SC-KK8515	SCIBIO-KAPA Hyper Plus kits for Illumina, no Amplification (96rxn)	626526

Custom Services Price List 2021-2022

Custom Code	Brief of Services	Minimum Quantity	Price (INR) Per Sample	IGST (CGST+SGST)	HSN Code
Item Code	Description of Services	Min.Qty.	Price	GST	HSN
SAMPLE PREPARATION					
John's_Q_01	DNA Extraction from Microbial Plates/Plant/Animal Tissue sample and its QC using Gel Electrophoresis	1	1500.00	18%	998346
John's_Q_02	DNA Extraction from Blood/ Soil sample and its QC using Gel Electrophoresis	1	2000.00	18%	998346
John's_Q_03	RNA Extraction from Microbial Plates/Plant/Animal Tissue sample and its QC using UV/Viz Spectrophotometer (260/280 & 260/230) and Gel Electrophoresis	1	2500.00	18%	998346
John's_Q_04	RNA Extraction from Blood/ Soil sample and its QC using UV/Viz Spectrophotometer (260/280 & 260/230) and Gel Electrophoresis	1	3000.00	18%	998346
John's_Q_05	Protein Isolation and purification from Plant/ Animal Tissue/ Microbial Media and its QC using PAGE/SDS PAGE	1	5000.00	18%	998346
John's_Q_06	Protein Digestion using proteolytic enzyme from Plant/ Animal Tissue/ Microbial protein	1	6000.00	18%	998346
John's_Q_07	Sample preparation for GCMS/LCMS-MS /Nano LC	1	4500.00	18%	998346
John's_Q_08	Library QC of NGS Samples	1	3000.00	18%	998346
NEXT GENERATION SEQUENCING ON ILLUMINA PLATFORM					
John's_ILQ_09	Illumina based Library QC using Qubit and TapeStation		1,500	18%	998346
John's_ILQ_10	Data Generation on Illumina NovaSeq 6000 for QC passed library		1,500/GB	18%	998346
John's_ILQ_11	De Novo Transcriptome/RNA Seq with mRNA OligoDT based enrichment Method(< 30 Million Reads/ ~5GB data) 150X2 Paired End LibrarySteps involved are RNA QC, Library Preparation, Library QC, Data Generation, Raw Data QC, Assembly, Annotation, Differential Gene Expression, Design of graphs, Pie-Charts, HeatMap's and whatever	1	23500	18%	998346

Item Code	Description of Services	Min.Qty.	Price	GST	HSN
	appropriate for Data Presentation maintaining publication Standards.				
John's_ILQ_12	Transcriptome/RNA Seq with Ribodepletion (~50 Million Reads/~8GB data) 150X2 Paired End Library Steps involved are RNA QC, Library Preparation, Library QC, Data Generation, Raw Data QC, Assembly, Annotation, Classification of RNA Family (mRNA, lncRNA, Linc RNA and etc) Differential Gene Expression, Design of graphs, Pie-Charts, HeatMap's and whatever appropriate for Data Presentation maintaining publication Standards.	1	30,000	18%	998346
John's_ILQ_13	De Novo Transcriptome/RNA Seq (~50 Million Reads/~8GB data) 150X2 Paired End Library Steps involved are RNA QC, Library Preparation, Library QC, Data Generation, Raw Data QC, Assembly, Annotation, Classification of RNA Family (mRNA, lncRNA, Linc RNA and etc) Differential Gene Expression, Design of graphs, Pie-Charts, HeatMap's and whatever appropriate for Data Presentation maintaining publication Standards.	1	27,000	18%	998346
John's_ILQ_14	De Novo Transcriptome/RNA Seq (>60 Million Reads/ 10GB Data) 150X2 Paired End Library Steps involved are RNA QC, Library Preparation, Library QC, Data Generation, Raw Data QC, Assembly, Annotation, Classification of RNA Family (mRNA, lncRNA, Linc RNA and etc) Differential Gene Expression, Design of graphs, Pie-Charts, HeatMap's and whatever appropriate for Data Presentation maintaining publication Standards.	1	30500	18%	998346
John's_ILQ_15	Reference/Alignment based (BLAST based) Transcriptome/RNA Seq (< 30 Million Reads/~5GB Data) 150X2 Paired End Library Steps involved are RNA QC, Library Preparation, Library QC, Data Generation, Raw Data QC, Alignment, Annotation, Differential	1	23500	18%	998346

Item Code	Description of Services	Min.Qty.	Price	GST	HSN
	Gene Expression, Design of graphs, Pie-Charts, HeatMap's and whatever appropriate for Data Presentation maintaining publication Standards.				
John's_ILQ_16	Reference/Alignment based (BLAST based) Analysis (~50 Million Reads/~8GB Data) 150X2 Paired End Library Steps involved are RNA QC, Library Preparation, Library QC, Data Generation, Raw Data QC, Alignment, Annotation, Classification of RNA Family (mRNA, lncRNA, Linc RNA and etc) Differential Gene Expression, Design of graphs, Pie-Charts, HeatMap's and whatever appropriate for Data Presentation maintaining publication Standards.	1	27,000	18%	998346
John's_ILQ_17	Reference/ Alignment based (BLAST based) Transcriptome/RNA Analysis (>60 Million Reads/ ~10GB Data) 150X2 Paired End Library Steps involved are Sample QC, Ribodepletion using Ribo Zero Treatment, Library Preparation, Data Generation, RNA QC, Data Generation, Raw Data QC, Alignment, Annotation, Classification of RNA Family (mRNA, lncRNA, Linc RNA and etc) Differential Gene Expression, Design of graphs, Pie-Charts, HeatMap's and whatever appropriate for Data Presentation maintaining publication Standards.	1	30500	18%	998346
John's_ILQ_18	De Novo Meta-Transcriptome Sequencing and Analysis (50 Million Reads and 150X2 Paired End Library) Steps involved are Sample QC, Ribodepletion using Ribo Zero Treatment, Library Preparation, Data Generation, RNA QC, Data Generation, Raw Data QC, Assembly, Annotation, Classification of RNA Family and cumulative Illumine, Top Biological functions, Gene Search, Differential Gene Expression, Design of graphs, Pie- Charts, HeatMap's and whatever appropriate for Data Presentation maintaining publication Standards.	1	31,500	18%	998346

Item Code	Description of Services	Min.Qty.	Price	GST	HSN
John's_ILQ_19	De Novo Meta-Transcriptome Sequencing and Analysis (>70 Million Reads and 150X2 Paired End Library)Steps involved are Sample QC, Ribodepletion using Ribo Zero Treatment, Library Preparation, Data Generation, RNA QC, Data Generation, Raw Data QC, Assembly, Annotation, Classification of RNA Family and cumulative function, Top Biological functions, Gene Search, Differential Gene Expression, Design of graphs, Pie- Charts, HeatMap's and whatever appropriate for Data Presentation maintaining publication Standards.	1	36,500	18%	998346
John's_ILQ_20	Alignment based (BLAST based) Meta-Transcriptome Analysis (>70 Million Reads and 150X2 Paired End Library) Steps involved are Raw Data QC, Assembly, Annotation, Classification of RNA Family and cumulative function, Top Biological functions, Gene Search, Differential Gene Expression, Design of graphs, Pie- Charts, HeatMap's and whatever appropriate for Data Presentation maintaining publication Standards. Support in writing Methodology, Results section in manuscript.	1	8,000	18%	998346
John's_ILQ_21	De Novo Sequencing and Analysis of small RNA (15 million reads, 50X2 Paired End Library): Steps involved are: Sample QC, Data Generation, RNA QC, Data Generation, Raw Data QC, Classification of small RNA Families (miRNA, siRNA, piRNA,etc), Annotation, binning into known and novel, functional prediction (target prediction), association with transcriptome (if needed), build network, Design of graphs, Pie-Charts, HeatMap's	1	28,500	18%	998346
John's_ILQ_22	ChIP Seq Data analysis (15 million reads): Sample QC, Data Generation, Raw Data QC, Alignment, search for true Motif's, Clustering Peak identification, Peak optimization, scoring and functional annotation and prediction (transcription factor,	1	28,500	18%	998346

Item Code	Description of Services	Min.Qty.	Price	GST	HSN
John's_ILQ_23	<p>binding domain). Design of graphs, Pie-Charts, HeatMap's</p> <p>ChIP Seq Data analysis (40 million reads):</p> <p>Raw Data QC, Alignment, search for true Motif's, Clustering Peak identification, Peak optimization, scoring and functional annotation and prediction (transcription factor, binding domain). Design of graphs, Pie-Charts, HeatMap's and whatever appropriate for Data Presentation maintaining publication Standards. Support in writing Methodology, Results section in manuscript.</p>	1	10,000	18%	998346
John's_ILQ_24	<p>ChIP Seq Data analysis (>40 million reads):Raw Data QC, Alignment, search for true Motif's, Clustering Peak identification, Peak optimization, scoring and functional annotation and prediction (Histone modification pattern, other binding domain). Design of graphs, Pie-Charts, HeatMap's and whatever appropriate for Data Presentation maintaining publication Standards. Support in writing Methodology,Results section in manuscript.</p>	3	12,000	18%	998346
John's_ILQ_25	<p>16S (v3-v4) Bacterial/ITS Fungal Metagenome Sequencing and Analysis (7Illumine 0.5-2 Million reads/ionS5 30K/50K/100K):</p> <p>DNA Sample QC, Library Preparation, Library QC, Data Generation, Raw Data, read clustering, Filtering of Chimera and PCR artifacts, classification of OTU's, functional association, rarefaction curve, estimation of diversity (alpha, beta & gamma), Design of graphs, Pie-Charts, HeatMap's and whatever appropriate for Data Presentation maintaining publication Standards. Support in writing Methodology, Results section in manuscript.</p>	1	10,000	18%	998346

Item Code	Description of Services	Min.Qty.	Price	GST	HSN
John's_ILQ_26	16S (v3-v4) Bacterial/ITS Fungal Metagenome Data Analysis (0.5-2 Million reads on S5 30K/50K/100K): DNA Sample QC, Data Generation, Raw Data, DNA Sample QC, Data Generation, Raw Data, read clustering, Filtering of Chimera and PCR artifacts, classification of OTU's, functional association, rarefaction curve, estimation of diversity (alpha, beta & gamma), Design of graphs, Pie-Charts, HeatMap's and whatever appropriate for Data Presentation maintaining publication Standards. Support in writing Methodology, Results section in manuscript.	3	2,500	18%	998346
John's_ILQ_27	De Novo- Whole Metagenome Sequencing (>50 million reads/ 8GB): Steps involved are DNA Sample QC, Library Preparation, Library QC, Data Generation, Raw Data QC, Assembly, Annotation, Biological functions and top pathways, Custom gene-pathway search, draft assembly of individual bacterial genomes (if possible), Plasmid Search, Design of graphs, Pie-Charts, HeatMap's and whatever appropriate for Data Presentation maintaining publication Standards. Support in writing Methodology, Results section in manuscript.	1	27,500	18%	998346
John's_ILQ_28	De Novo- Whole Metagenome Sequencing (>60 million reads/ 10GB Data): Steps involved are DNA Sample QC, Library Preparation, Library QC, Data Generation, Raw Data QC, Assembly, Annotation, Biological functions and top pathways, Custom gene-pathway search, draft assembly of individual bacterial genomes (if possible), Plasmid Search, Design of graphs, Pie-Charts, HeatMap's and whatever appropriate for Data Presentation maintaining publication Standards. Support in writing Methodology, Results section in manuscript.	1	30,500	18%	998346

Item Code	Description of Services	Min.Qty.	Price	GST	HSN
John's_ILQ_29	De Novo- Whole Metagenome Sequencing (>100 million(15GB) reads illumine/ Nanopore(3GB) hybrid): Steps involved are DNA Sample QC, Library Preparation, Library QC, Data Generation, Raw Data QC, Assembly, Annotation, Biological functions and top pathways, Custom gene-pathway search, draft assembly of individual bacterial genomes (if possible), Plasmid Search, Design of graphs, Pie-Charts, HeatMap's and whatever appropriate for Data Presentation maintaining publication Standards. Support in writing Methodology, Results section in manuscript.	1	85,000	18%	998346
John's_ILQ_30	Alignment based Whole Metagenome Sequencing (<50 million reads/ 8 GB): Steps involved are DNA Sample QC, Data Generation, Raw Data, Raw Data QC, Ref. Database based Alignment, Annotation, Biological functions and top pathways, Custom gene-pathway search, draft assembly of individual bacterial genomes (if possible), Plasmid Search, Design of graphs, Pie-Charts, HeatMap's and whatever appropriate for Data Presentation maintaining publication Standards. Support in writing Methodology, Results section in manuscript.	1	27,500	18%	998346
John's_ILQ_31	Alignment based Whole Metagenome Sequencing (>60 million reads/ 10 GB):Steps involved are Raw Data QC, Ref. Database based Alignment, Annotation, Biological functions and top pathways, Custom gene-pathway search, draft assembly of individual bacterial genomes (if possible), Plasmid Search, Design of graphs, Pie-Charts, HeatMap's and whatever appropriate for Data Presentation maintaining publication Standards. Support in writing Methodology, Results section in manuscript.	1	30,500	18%	998346

Item Code	Description of Services	Min.Qty.	Price	GST	HSN
John's_ILQ_32	Alignment based Whole Metagenome Sequencing (>100 million (15GB) reads illumine/ Nanopore(3GB) hybrid): Steps involved are DNA Sample QC, Library Preparation, Library QC, Data Generation, Raw Data, Raw Data QC, Ref. Database based Alignment, Annotation, Biological functions and top pathways, Custom gene-pathway search, draft assembly of individual bacterial genomes (if possible), Plasmid Search, Design of graphs, Pie-Charts, HeatMap's and whatever appropriate for Data Presentation maintaining publication Standards. Support in writing Methodology, Results section in manuscript.	1	85,000	18%	998346
John's_ILQ_33	Whole Genome Sequencing and Analysis (1 Gb of illumine Raw data): Steps involved are DNA Sample QC, Library Preparation, Library QC, Data Generation, Raw Data, Raw Data QC, Assembly using minimum 2 Assemblers and selection of the best k-mer and n50, Annotation using close reference, Gene Pathway analysis, completion of Draft using tools for scaffold stitching, submission of raw data to NCBI, Design of graphs, Pie-Charts, HeatMap's and whatever appropriate for Data Presentation maintaining publication Standards. Support in writing Methodology, Results section in manuscript.	1	15,000	18%	998346
John's_ILQ_34	Whole Genome Sequencing Analysis (10 Gb of illumine Raw data): Steps involved are Raw Data QC, Assembly using minimum 2 Assemblers and selection of the best k-mer and n50, Annotation using close reference, Gene Pathway analysis, completion of Draft using tools for scaffold stitching, submission of raw data to NCBI, Design of graphs, Pie-Charts, HeatMap's and whatever appropriate for Data Presentation maintaining publication Standards. Support in writing Methodology, Results section in manuscript.	1	27,500	18%	998346

Item Code	Description of Services	Min.Qty.	Price	GST	HSN
John's_ILQ_35	Whole Genome Sequencing and Analysis (100 Gb of illumine Raw data):Steps involved are Raw Data QC, Assembly using minimum 2 Assemblers and selection of the best k-mer and n50, Annotation using close reference, Gene Pathway analysis, completion of Draft using tools for scaffold stitching, submission of raw data to NCBI, Design of graphs, Pie-Charts, HeatMap's and whatever appropriate for Data Presentation maintaining publication Standards. Support in writing Methodology,Results section in manuscript.	1	130,000	18%	998346
John's_ILQ_36	Whole Genome Sequencing and Analysis (<30 Gb of Mate pair illumine Raw data): Steps involved are Sample QC, Library Preparation, Library QC, Raw Data QC, Secondary assembly using mate pair library to improve primary De Novo assembly using short reads from illumine/thermo ion s5 platform. And whatever appropriate for Data Presentation maintaining publication Standards. Support in writing Methodology, Results section in manuscript.	1	80,000	18%	998346
John's_ILQ_37	Whole Genome Sequencing Analysis (100-150 Gb of Mate pair illumine Raw data): Steps Involved are Raw Data QC, Secondary assembly using mate pair library to improve primary De Novo assembly using short reads from illumine/thermo ion s5 platform.	1	35,000	18%	998346
John's_ILQ_38	Whole Genome Sequencing Analysis for SMRT Pacbio Sequel II (30 Gb PacBio Raw Data, CCS Library Reads >15KB): Plant/Animal Sample Steps Involved are Sample QC, SMRT Library, QC, Raw Data QC, Secondary assembly using long single molecule sequencing platform.	1	325,000	18%	998346
John's_ILQ_39	Whole Genome Sequencing Analysis for SMRT Pacbio Sequel II (5 Gb PacBio Raw Data, CCS Library Reads >15KB): Plant/Animal Sample Steps Involved are Sample QC, SMRT	1	125,000	18%	998346

Item Code	Description of Services	Min.Qty.	Price	GST	HSN
	Library, QC, Raw Data QC, Secondary assembly using long single molecule sequencing platform.				
John's_ILQ_40	Whole Genome Methylome analysis from RRBS/ MeDIP Sequencing (5-15 Gb) : Steps involved are Raw data QC, Assembly/Alignment as appropriate from CPG islands converted library, annotation, indels, CNV, SNV analysis Variant calling (in alignment only). Design of graphs, Pie- Charts, HeatMap's and whatever appropriate for Data Presentation maintaining publication Standards. Support in writing Methodology, Results section in manuscript.	1	10,000	18%	998346
John's_ILQ_41	Whole Genome Re-Sequencing Analysis (Up to 10 Gb of 10Illumine Raw data): Steps involved are Raw Data QC, Alignment using BWA/Bowtie2, Annotation, indels, CNV, SNV analysis Variant calling, annotation of variant, effects of variants and novel variant reporting, submission of raw data to NCBI, Design of graphs, Pie- Charts, HeatMap's and whatever appropriate for Data Presentation maintaining publication Standards. Support in writing Methodology, Results section in manuscript.	1	7,000	18%	998346
John's_ILQ_42	Whole Genome Re-Sequencing Analysis (50) Gb of 10Illumine Raw data): Steps involved are Raw Data QC, Alignment using BWA/Bowtie2, Annotation, indels, CNV, SNV analysis Variant calling, annotation of variant, effects of variants and novel variant reporting, submission of raw data to NCBI, Design of graphs, Pie- Charts, HeatMap's and whatever appropriate for Data Presentation maintaining publication Standards. Support in writing Methodology, Results section in manuscript.	1	15,000	18%	998346
John's_ILQ_43	Whole Genome Re-Sequencing Analysis (100) Gb of 11Illumine Raw data): Steps involved are Raw Data QC, Alignment using BWA/Bowtie2, Annotation, indels, CNV, SNV analysis	1	25000	18%	998346

Item Code	Description of Services	Min.Qty.	Price	GST	HSN
	Variant calling, annotation of variant, effects of variants and novel variant reporting, submission of raw data to NCBI, Design of graphs, Pie- Charts, HeatMap's and whatever appropriate for Data Presentation maintaining publication Standards. Support in writing Methodology, Results section in manuscript.				
John's_ILQ_44	Hi-C Sequencing using Illumina (30GB) Hi-C Library Preparation, QC, Data Generation, Data QC, Data Analysis:		135000	18%	998346
John's_ILQ_45	Exosome/Extracellular RNA Sequencing Data Analysis 60 million Reads, 50X2 Pair End Library RNA QC, Sequencing on Illumina NovaSeq 6000, Data QC and Analysis • Standard Data Analysis-RNA Composition Analysis-Expression Profiles of small RNA (miRNA, piRNA, snoRNA, snRNA, Y RNA, vault RNA} and mRNA-Novel miRNA prediction • Advanced Data Analysis-Differentially expressed small RNAs-Customized Analysis	1	31,500	18%	998346
John's_ILQ_46	WGBS (Whole Genome Bisulfite Sequencing) Methylation Sequencing) 30X Coverage (60 GB Data) Comparison of the sequence obtained from the bisulfite-treated library to the published sequence enables the identification of differential methylations. The methylation state on the target regions, e.g. CpG islands) can be quantitatively characterized. •Standard Data Analysis -Global Methylation Profiles -Specific Methylation Profiles [CG Islands Differentially Methylation Regions (DMRs))	1	90,000	18%	998346
John's_ILQ_47	WGBS (Whole Genome Bisulfite Sequencing) Methylation Sequencing) 70X Coverage (200 GB Data) – Bovine/Human/Plant Comparison of the sequence obtained from the bisulfite-treated library to the published sequence enables the identification of differential methylations. The methylation state on the target regions, e.g. CpG islands) can be quantitatively	1	275,000	18%	998346

Item Code	Description of Services	Min.Qty.	Price	GST	HSN
	<p>haracterized.</p> <ul style="list-style-type: none"> •Standard Data Analysis -Global Methylation Profiles -Specific Methylation Profiles 				
John's_ILQ_48	<p>WGBS (Whole Genome Bisulfite Sequencing) Methylation Sequencing) 100X Coverage (350 GB Data)– Bovine/Human/PlantComparison of the sequence obtained from the bisulfite-treated library to the published sequence enables the identification of differential methylations. The methylation state on the target regions, e.g. CpG islands) can be quantitatively characterized. •Standard Data Analysis-Global Methylation Profiles-Specific Methylation Profiles[CG Islands Differentially Methylation Regions (DMRs)]•Advanced Data Analysis-DMR-Associated Genes-Gene Set Analysis-Comparative Analysis</p>	1	450,000	18%	998346
John's_ILQ_49	<p>Human Genome Sequencing – 10X DNA QC, Library Preparation and QC. Data Generation on Illumina NovaSeq 6000 with 150 X 2 chemistry. Raw Data QC, Assembly using minimum 2 Assemblers and selection of the best k-mer and n50, Annotation using close reference, Gene Pathway analysis, completion of Draft using tools for scaffold stitching, submission of raw data to NCBI, Design of graphs, Pie- Charts, HeatMap's and whatever appropriate for Data Presentation maintaining publication Standards. Support in writing Methodology, Results section in manuscript.</p>	1	60,000	18%	998346

Item Code	Description of Services	Min.Qty.	Price	GST	HSN
John's_ILQ_50	Human Genome Sequencing – 30X DNA QC, Library Preparation and QC. Data Generation on Illumina NovaSeq 6000 with 150 X 2 chemistry. Raw Data QC, Assembly using minimum 2 Assemblers and selection of the best k-mer and n50, Annotation using close reference, Gene Pathway analysis, completion of Draft using tools for scaffold stitching, submission of raw data to NCBI, Design of graphs, Pie- Charts, HeatMap's and whatever appropriate for Data Presentation maintaining publication Standards. Support in writing Methodology, Results section in manuscript.	1	125,000	18%	998346
John's_ILQ_51	Bovine Exome Sequencing DNA QC, Exome Capture using Agilent 'SureSelect non- human Exomes' sequencing using Illumina NovaSeq 6000 to generation ~ 6.5 GB data/sample. Data QC, Alignment, Calling of variation, Annotation of Variants Correlation of Variants with Hypothesis.	8	41,000/S ample	18%	998346

SINGLE CELL GENOMICS: 10X CHROMIUM

John's_ILQ_52	Single Cell RNA Sequencing Sample QC (12000 Live cell count Per sample) and minimum 90GB data Per Lane (22K Reads Per Cells) Sequencing on Illumina Novaseq 6000 Standard Data Analysis: Gene expression and cell clustering analysis Simultaneous single cell analysis of gene expression, immune profiling and cell surface protein expression	8	3,500,000	18%	998346
John's_ILQ_53	Single Cell ATAC Sequencing Sample QC (12000 Live cell count Per sample) and minimum 90GB data Per Lane (22K Reads Per Cells) Sequencing on Illumina Novaseq 6000 Standard Data Analysis Chromatin accessibility profiles and cell clustering analysis		POR	18%	998346

Item Code	Description of Services	Min.Qty.	Price	GST	HSN
John's_ILQ_54	Single Cell immune Profiling Sample QC (12000 Live cell count Per sample) and minimum 90GB data Per Lane (22K Reads Per Cells) Sequencing on Illumina Novaseq 6000 Standard Data Analysis Paired full length V(DI) gene sequence identification Clonality and diversity of TCR and/or BCR		POR	18%	998346
John's_ILQ_55	Single Cell Surface protein Profiling Sample QC (12000 Live cell count Per sample) and minimum 90GB data Per Lane Sequencing on Illumina Novaseq 6000 Standard Data Analysis Surface protein expression and cell clustering analysis		POR	18%	998346
John's_ILQ_56	Single Cell CNV Profiling Sample QC (12000 Live cell count Per sample) and minimum 90GB data Per Lane Sequencing on Illumina Novaseq 6000 Standard Data Analysis Chromatin accessibility profiles Cell clustering analysis [CG Islands Differentially Methylated Regions (DMRs)]		POR	18%	998346
John's_ILQ_57	Single Cell Advanced Data Analysis (~1TB Data) -Sample aggregation -Gene expression and cell clustering analysis -Cell identification -Differentially Expressed Genes (DEGs) analysis -Gene Ontology analysis -Trajectory analysis		1,000,000	18%	998346

LONG READ SEQUENCING USING PACBIO & NANOPORE

John's_ILQ_58	Full SMRT Cell PacBio : SMRT bell Library QC and Data generation Per HiFi SMRT Sequencing (> 250GB) 5 to 7% Conversion for HiFi reads (~Q50) Note: Only Eukaryotic Genome Sample		650,000.0 0	18%	998346
John's_ILQ_59	Whole Human Genome using Long Read Chemistry CCS- Library Preparation for Long Read Sequencing chemistry PacBio SMRTbell Library sample starting from ~5-20 ng of gDNA to a sufficient quantity for		350,000.0 0	18%	998346

Item Code	Description of Services	Min.Qty.	Price	GST	HSN
John's_ILQ_60	template preparation 90GB Data with standard analysis Genome Finishing & De novo Assembly - 100X Coverage Long Read Sequencing chemistry Sequencing Platforms: PacBio Sequel • Support of multiple applications: genome finishing, metagenomics, De novo assembly, meta-assembly with long & short reads. • High-quality reads of up to 20Kb		Price on Request	18%	998346
John's_ILQ_61	Whole Human Genome Phasing 100X Coverage Long Read Sequencing chemistry Sequencing Platforms: PacBio Sequel • Examines the unique haplotype content of two homologous chromosome • One assay to phase over 94% of heterozygous SNPs and InDels		Price on Request	18%	998346
John's_ILQ_62	Nanopore Sequencing Data Generation (1 GB) Oxford Nanopore Library, QC and Data Generation		50,000	18%	998346
John's_ILQ_63	Nanopore Sequencing Data Generation (3 GB), Oxford Nanopore Library, QC and Data Generation		65,000	18%	998346
SANGER SEQUENCING SERVICES					
John's_ILQ_64	Fragment Analysis Using Sanger Sequencing Maximum Length 1200KB Sequencer- Thermofisher ABI Data in Fasta file and .ab1 TAT 10 Days after sample QC	25 samples	550/rxn	18%	998346
John's_ILQ_65	Plasmid Sequencing using Sanger Sequencing Maximum Length 700 Bases , Sequencer- Thermofisher ABI Data in Fasta file and .ab1 TAT 10 Days after sample QC	25 samples	450/rxn	18%	998346
John's_ILQ_66	Sanger Sequencing for PCR Products Sample: Purified Sample Maximum Length 700 Bases Per Reaction Sequencer- Thermofisher ABI, Data in Fasta file and .ab1 TAT 10 Days after sample QC	25 Samples	450/rxn	18%	998346
John's_ILQ_67	Sample Purification of PCR amplified Products	25 Samples	200/rxn	18%	998346
John's_ILQ_68	Plasmid Sequencing using Illumina Novaseq 6000 Sequencing	1	15,000	18%	998346
John's_ILQ_69	Pure Culture plate/Slant/Pellet and single End Sequencing and data in Fasta	1	2500	18%	998346

Item Code	Description of Services	Min.Qty.	Price	GST	HSN
John's_ILQ_70	Pure Culture plate/Slant/Pellet and Double End Sequencing and data in Fasta	1	3500	18%	998346
John's_ILQ_71	Pure Culture plate/Slant/Pellet and Double End Sequencing and data in Fasta and Phylogenetics Tree and report	1	5000	18%	998346
John's_ILQ_72	DNA Barcoding study of Plant / Animal sample	1	7500	18%	998346
John's_ILQ_73	GMO testing of Plants	1	6500	18%	998346
John's_ILQ_74	RT PCR based Gene Expression Analysis	1	POR	18%	998346
MICROARRAY AND GENOTYPING					
John's_ILQ_75	GBS/DDRAD for Plant/Animal – Data Generation and Analysis	96	350,000	18%	998346
John's_ILQ_76	Illumina Beadarray Bovine HD Chip – 50K SNP		15,000	18%	998346
John's_ILQ_77	Illumina Beadarray Rice SNP IRRI 7K Chip Sequencing and Data analysis		4,700	18%	998346
John's_ILQ_78	Illumina Beadarray Ovine SNP50 chip		POR	18%	998346
John's_ILQ_79	Illumina Global Screening Array (GSA) Human Beadchip		4,800	18%	998346
John's_ILQ_80	Cotton SNP Chip		POR	18%	998346
John's_ILQ_81	MicroArray Services for Plant/ Animal		POR	18%	998346
John's_ILQ_82	Infinium HTS iSelect Custom Beadchips		POR	18%	998346
John's_ILQ_83	Infinium XT		POR	18%	998346
John's_ILQ_84	Genotyping by Sequencing Standardization for new species	96 Plex	120,000.00	18%	998346
John's_ILQ_85	Genotyping by sequencing (96 Plex) with standard Analysis	96 Plex	4,50,590.00	18%	998346
John's_ILQ_86	Genotyping by sequencing (192 Plex) with standard Analysis	192 Plex	6,90,590.00	18%	998346
John's_ILQ_87	Genotyping by sequencing (288Plex) with standard Analysis	288 Plex	8,51,590.00	18%	998346
John's_ILQ_88	Genotyping by sequencing (384 Plex) with standard Analysis	384 Plex	9,90,590.00	18%	998346
PROTEOMICS & ANALYTICAL SERVICES					
John's_ILQ_89	Quantitative Proteomics – Orbitrap fusion tribrid Mass Spectrometry with TMT Labelling – 10 Plex Machine Run Time – 180 min Per Fraction, 3 Technical Replicates, 18 Fractions Plus one QC, Data Analysis using Proteome Discoverer and Sequest HT databases		650,000	18%	998346
John's_ILQ_90	Qualitative Proteomics using LCMS/MS and Standard Library		12000	18%	998346

Item Code	Description of Services	Min.Qty.	Price	GST	HSN
John's_ILQ_91	- Proteolytic sample required for LCMS analysis MALDI – TOF of Proteins In Gel Proteolytic digested sample required for LCMS analysis		8000	18%	998346
John's_ILQ_92	GSMS of Plant/ Animal/Microbial Extract in GC suitable solvent		8000	18%	998346
John's_ILQ_93	PTM Analysis of Complex Proteins Sample required in pure form and in suitable buffer		35,000	18%	998346
John's_ILQ_94	Proteomics Sequencing using LCMS/MS and Standard Library Proteolytic sample required for LCMS analysis		16000	18%	998346
John's_ILQ_95	SEM/TEM Analysis		5000	18%	998346
John's_ILQ_96	HPLC Analysis of Per run		4500	18%	998346
John's_ILQ_97	MALDI Analysis of Protein sample		10000	18%	998346
CUSTOM OLIGO SYNTHESIS					
John's_ILQ_98	Oligo Synthesis 25nMol Desalted		18	12%	38220090
John's_ILQ_99	Oligo Synthesis 50 nMol Desalted		28	12%	38220090
John's_ILQ_100	Oligo Synthesis 100 nMol Desalted		1,500/GB	12%	38220090
John's_ILQ_101	Modified Oligo synthesis at 5* / 3* Site		POR	18%	998346
John's_ILQ_102	Custom Peptide Synthesis		POR	18%	998346
John's_ILQ_103	Oligo Purification Using HPLC		4500	18%	998346
John's_ILQ_104	Custom RNA Synthesis		700	18%	998346
John's_ILQ_105	Custom Gene Synthesis		POR	18%	998346
MOLECULAR BIOLOGY KITS					
John's_ILQ_106	DNA Extraction Kit 100 Rxn		10,000	12%	38220090
John's_ILQ_107	RNA Extraction Kit 100 Rxn		20,000	12%	38220090
John's_ILQ_108	PCR Master Mix 100 Rxn		25,000	12%	38220090
John's_ILQ_109	RNA Stabilization Reagent		25,000	12%	38220090
John's_ILQ_110	Plasmid Extraction Kit 100 Rxn		22,000	12%	38220090
John's_ILQ_111	Expression / Cloning Vector		25,000	12%	38220090
SAMPLE PREREQUISITE					
RNA:			DNA:		
RIN >7			Concentration >150ng/ul Total Amount – 5 ug		
Concentration >150ng/ul Total Amount – 5 ug			OD – A260/280>1.8, A260/230>2		
OD – A260/280>1.8, A260/230>2			Gel Picture with clear band		
Gel Picture with clear band			Concentration >150ng/ul Total Amount – 5 ug		
			OD – A260/280>1.8, A260/230>2		
			Gel Picture with clear band		

HSN CODE:

Oligo/Molecular Biology Kits: 38220090 (Applicable GST 12%)

Custom Services: 998346 (Applicable GST 18%)

Product Code	Description	Pack Size	Price
PB-C-ATP-100G	Adenosine 5'-triphosphate	100 g	81536
PB-C-ATP-20G	Adenosine 5'-triphosphate	20 g	22880
PB-C-CLFR-10G	Calcofluor Fluorescent Stain	10g	35360
PB-C-CLFR-5G	Calcofluor Fluorescent Stain	5g	20592
PB-C-COA500	Coenzyme A (trilithium salt)	500 mg	136656
PB-C-NAD-25G	β -Nicotinamide Adenine Di-nucleotide	25g	95888
PB-C-NAD-5G	β -Nicotinamide Adenine Di-nucleotide	5g	27040
PB-C-NADH-10G	β -Nicotinamide Adenine Di-nucleotide Reduced Salt	10g	87152
PB-C-NADH-2G	β -Nicotinamide Adenine Di-nucleotide Reduced Salt	2g	21424
PB-C-NADP-10G	β -Nicotinamide Adenine Di-nucleotide Phosphate	10g	143520
PB-C-NADP-2G	β -Nicotinamide Adenine Di-nucleotide Phosphate	2 g	34528
PB-C-PEP-10G	Phosphoenolpyruvate (PEP)	10g	139152
PB-C-PEP-2G	Phosphoenolpyruvate (PEP)	2g	33488
PB-D-MQWAVE-1	MegaQuant™ Wave Spectrophotometer / MegaQuant™ Wave Starter Pack (Chemistry Analyzer)	MegaQuant™ Wave Spectrophotometer	530400
PB-D-MQWAVE-2	MegaQuant™ Wave Spectrophotometer / MegaQuant™ Wave Starter Pack (Chemistry Analyzer)	MegaQuant™ Wave Starter Pack	832000
PB-E-ABFAN	α -L-Arabinofuranosidase (<i>Aspergillus nidulans</i>)	500 units	31824
PB-E-ABFBO17	α -L-Arabinofuranosidase B17 (<i>Bacteroides ovatus</i>)	2,000 units	31824
PB-E-ABFBO21	α -L-Arabinofuranosidase B21 (<i>Bacteroides ovatus</i>)	200 units	31824
PB-E-ABFBO25	α -L-Arabinofuranosidase B25 (<i>Bacteroides ovatus</i>)	200 units	31824
PB-E-ABFCJ	α -L-Arabinofuranosidase (<i>Cellvibrio japonicus</i>)	500 units	34528
PB-E-ABFCT	α -L-Arabinofuranosidase (<i>Clostridium thermocellum</i>)	500 units	34528
PB-E-ABFUM	α -L-Arabinofuranosidase (<i>Ustilago maydis</i>)	400 units	31824
PB-E-ACPEC	Phosphatase (Acid) (<i>Escherichia coli</i>)	400 units	26624
PB-E-AC SBS	Acetyl-CoA synthetase (<i>Bacillus subtilis</i>)	250 units	43056
PB-E-ADHEC	Alcohol dehydrogenase (<i>E. coli</i>)	1,000 units	27664
PB-E-AFAM2	α -L-Arabinofuranosidase (novel specificity) (<i>Bifidobacterium adolescentis</i>)	400 units	32448
PB-E-AFASE	α -L-Arabinofuranosidase (<i>Aspergillus niger</i>)	480 units	30784
PB-E-AGALPS	α -Galactosidase (<i>Penicillium simplicissimum</i>)	2,000 units	31824
PB-E-AGLAN	α -Galactosidase (<i>Aspergillus niger</i>)	2,000 units	33488
PB-E-AGLANP	α -Galactosidase (<i>Aspergillus niger</i>) Powder	3,000 units	37232
PB-E-AGLGU	α -Galactosidase (<i>Guar</i>)	1,000 units	33488
PB-E-AGLUTM	α -Glucosidase (thermostable) (<i>Thermotoga maritima</i>)	500 units	32864
PB-E-AGUBS	α -Glucuronidase (<i>Geobacillus stearothermophilus</i>) (Recombinant)	200 units	28496
PB-E-ALGLS	Alginate lyase (<i>Sphingomonas sp.</i>)	5,000 units	32864
PB-E-ALPEC	Phosphatase (Alkaline) (<i>E. coli</i>)	400 units	22880
PB-E-AMANBT	α -D-Mannosidase (<i>Bacteroides thetaiotaomicron</i>)	10 units	31824
PB-E-AMANTM	α -(1-2,3,4,6)-D-Mannosidase (<i>Thermotoga maritima</i>)	5 units	31824
PB-E-AMGDF-100ML	Amyloglucosidase (<i>Aspergillus niger</i>)	100 ml	60528
PB-E-AMGDF-10ML	Amyloglucosidase (<i>Aspergillus niger</i>)	10 ml	11648
PB-E-AMGDF-40ML	Amyloglucosidase (<i>Aspergillus niger</i>)	40 ml	30160
PB-E-AMGDF-A-100ML	Amyloglucosidase (<i>Aspergillus niger</i>)	100ml (ANKOM)	58656
PB-E-AMGDFNG-20ML	Amyloglucosidase (<i>Aspergillus niger</i>) Glycerol Free	20 ml	29328
PB-E-AMGDFNG-50ML	Amyloglucosidase (<i>Aspergillus niger</i>) Glycerol Free	50 ml	58656
PB-E-AMGDFPD	Amyloglucosidase (<i>Aspergillus niger</i>) Powder	4 g - 36,000 units/g	34944
PB-E-AMGFR-100MG	Amyloglucosidase (<i>Aspergillus niger</i>)	100 mg	30576
PB-E-AMGFR-500MG	Amyloglucosidase (<i>Aspergillus niger</i>)	500 mg	87360
PB-E-AMGPU	Amyloglucosidase (<i>Rhizopus sp.</i>)	5,000 units	35360

Product Code	Description	Pack Size	Price
PB-E-AMPK	Adenylate kinase (Myokinase) (prokaryote)	10,000 units	32032
PB-E-ANAAM	α -Amylase (<i>Aspergillus oryzae</i>)	20,000 units	28496
PB-E-ANAGM	α -N-Acetylgalactosaminidase (microbial)	2 units	39312
PB-E-ARBACJ	endo- / exo-Arabinanase (<i>Cellvibrio japonicus</i>)	3,000 units	34528
PB-E-ASNEC	Asparaginase (<i>E. coli</i>)	400 units	22880
PB-E-AXEAO-1KU	Acetylxylyl esterane (Orpinomyces sp.)	1,000 units	19760
PB-E-AXEAO-3KU	Acetylxylyl esterane (Orpinomyces sp.)	3,000 units	42224
PB-E-AXSEC	α -Xylosidase (<i>Escherichia coli</i>)	20 units	31824
PB-E-BAASS	α -Amylase (<i>Bacillus amyloliquefaciens</i>)	2,900 units	26208
PB-E-BAMBC	β -Amylase (<i>Bacillus cereus</i>)	20,000 units	34528
PB-E-BARBL-100KU	β -Amylase (Barley)	100,000 units	54704
PB-E-BARBL-50KU	β -Amylase (Barley)	50,000 units	31824
PB-E-BARBP-2G	β -Amylase (Barley) (powder)	2g	35984
PB-E-BARBP-5G	β -Amylase (Barley) (powder)	5g	55120
PB-E-BGLAEC	β -Glucuronidase (<i>E. coli</i>)	500000 units	39312
PB-E-BGLAN	β -Galactosidase (<i>Aspergillus niger</i>)	8000 units	30992
PB-E-BGLUC	β -Glucosidase (<i>Aspergillus niger</i>)	200 units	45136
PB-E-BGOSAG	β -Glucosidase (<i>Agrobacterium</i> sp.)	600 units	35152
PB-E-BGOSPC	β -Glucosidase (Thermostable) (<i>Phanerochaete chrysosporium</i>)	1380 units	32864
PB-E-BGOSTM	β -Glucosidase (Thermostable) (<i>Thermotoga maritima</i>)	460 units	40560
PB-E-BLAAM-100ML	α -Amylase (<i>Bacillus licheniformis</i>)	100mL - 3000 units/mL	54288
PB-E-BLAAM-10ML	α -Amylase (<i>Bacillus licheniformis</i>)	10mL - 3000 units/mL	10608
PB-E-BLAAM-40ML	α -Amylase (<i>Bacillus licheniformis</i>)	40mL - 3000 units/mL	27248
PB-E-BLAAM-A-100ML	α -Amylase (<i>Bacillus licheniformis</i>)	100mL - 750 units/mL (ANKOM)	13312
PB-E-BMABC	endo-1,4- β -Mannanase (<i>Bacillus circulans</i>)	1000 units	32864
PB-E-BMABS	endo-1,4 β -Mannanase (<i>Bacillus</i> sp.)	2000 units	28496
PB-E-BMACJ	endo-1,4 β -Mannanase (<i>Cellvibrio japonicus</i>)	10000 units	34528
PB-E-BMANN	endo-1,4 β -Mannanase (<i>Aspergillus niger</i>)	600 units	28496
PB-E-BMATM	endo-1,4 β -Mannanase (<i>Thermotoga maritima</i>)	250 units	25168
PB-E-BMOSCF	β -Mannosidase (<i>Cellulomonas fimi</i>)	200 units	35152
PB-E-BNAHEX	β -N-Acetylhexosaminidase (microbial)	5 units	32864
PB-E-BNAHP	β -N-Acetylhexosaminidase (prokaryote)	100 units	31824
PB-E-BSPRPD	Protease Subtilisin A (from <i>Bacillus licheniformis</i>) Powder	1 g	34528
PB-E-BSPRT-100ML	Protease (Subtilisin A from <i>Bacillus licheniformis</i>)	100 ml	87152
PB-E-BSPRT-10ML	Protease (Subtilisin A from <i>Bacillus licheniformis</i>)	10 ml	17264
PB-E-BSPRT-40ML	Protease (Subtilisin A from <i>Bacillus licheniformis</i>)	40 ml	43472
PB-E-BSPRT-A-100ML	Protease (Subtilisin A from <i>Bacillus licheniformis</i>)	100ML (ANKOM)	42432
PB-E-BXSEBP	β -Xylosidase (<i>Bacillus pumilus</i>)	200 units	34528
PB-E-BXSR-1KU	β -D-Xylosidase (<i>Selenomonas ruminantium</i>)	1,000 units	21840
PB-E-BXSR-3KU	β -D-Xylosidase (<i>Selenomonas ruminantium</i>)	3,000 units	42640
PB-E-CATLQ	Catalase (<i>Aspergillus niger</i>)	400,000 units	33904
PB-E-CBHI	Cellobiohydrolase I (<i>Trichoderma longibrachiatum</i>)	20 mg	23296
PB-E-CBHIIM	Cellobiohydrolase II (microbial)	200 units	31824
PB-E-CELAN	Cellulase (endo-1,4- β -D-glucanase) (<i>Aspergillus niger</i>)	2,000 units	29952
PB-E-CELBA	Cellulase (endo-1,4- β -D-glucanase) (<i>Bacillus amyloliquefaciens</i>)	3,500 units at 40oC; 7,100 units at 60oC	34528
PB-E-CELTE	Cellulase (endo-1,4- β -D-glucanase) (<i>Talaromyces emersonii</i>)	2,000 units	32864
PB-E-CELTH	Cellulase (endo-1,4- β -D-glucanase) (<i>Thermobifida halotolerans</i>)	300 units	31824

Product Code	Description	Pack Size	Price
PB-E-CELTM	Cellulase (<i>endo</i> -1,4- β -D-glucanase) (<i>Thermotoga maritima</i>)	2000 units	34528
PB-E-CELTR	Cellulase (<i>endo</i> -1,4- β -D-glucanase) (<i>Trichoderma longibrachiatum</i>)	1000 units	30992
PB-E-CITEC	Citrate synthase (<i>E. coli</i>)	2500 units	32448
PB-E-CMPK	Cytidylate kinase (prokaryote)	500 units	35568
PB-E-CREA	Creatinase (<i>Bacillus</i> sp.)	350 units	28496
PB-E-DEXT	Dextranase (<i>Chaetomium</i> sp.)	320000 units	21216
PB-E-DIAEC	Diaphorase (<i>E. coli</i>)	1000 units	34944
PB-E-DIPEP	α -Aspartyl dipeptidase E (<i>E. coli</i>)	2000 units	28704
PB-E-DLDHLM	D-Lactate dehydrogenase (<i>Leuconostoc mesenteroides</i>)	22000 units	24336
PB-E-DMDHEC	D-Malate dehydrogenase (<i>E. coli</i>)	200 units	24544
PB-E-EARAB	<i>endo</i> -1,5- α -Arabinanase (<i>Aspergillus niger</i>)	400 units	28496
PB-E-EGALN	<i>endo</i> -1,4- β -Galactanase (<i>Aspergillus niger</i>)	1000 units	30992
PB-E-ENDOIAN	<i>endo</i> -Inulinase (<i>Aspergillus niger</i>) (Recombinant)	500 units	25792
PB-E-EXBGOS	<i>exo</i> -1,3- β -D-Glucanase + β -Glucosidase	3,000 units	34528
PB-E-EXBGTV	<i>exo</i> -1,3- β -D-Glucanase (<i>Trichoderma virens</i>) (Recombinant)	400 units	29952
PB-E-EXG5AO	<i>exo</i> -1,3- β -D-Glucanase (<i>Aspergillus oryzae</i>) (Recombinant)	500 units	28496
PB-E-EXOIAN	<i>exo</i> -Inulinase (<i>Aspergillus niger</i>) (Recombinant)	5000 units	27872
PB-E-EXPGA	<i>exo</i> -Polygalacturonase	500 units	31824
PB-E-FAERU	Feruloyl esterase (rumen microorganism)	1,000 units	32864
PB-E-FAEZCT	Feruloyl esterase (<i>Clostridium thermocellum</i>)	10 Units on ethyl ferulate	32864
PB-E-FDHCB	Formate dehydrogenase (<i>Candida boidinii</i>)	300 units at 25oC; ~ 600 units at 37oC	32032
PB-E-FRMXLQ	Fructanase Mixture (purified-liquid)	10 ml	34125
PB-E-FRMXPD	Fructanase Mixture (purified-powder)	20,000 units	34125
PB-E-FUCHS	α -(1-2,3,4,6)-L-Fucosidase (<i>Homo sapiens</i>)	10 units at 25oC	31824
PB-E-FUCM	1,2- α -L-Fucosidase (microbial)	3 units at 37oC	39312
PB-E-FUCTM	α -Fucosidase (Thermostable) (<i>Thermotoga maritima</i>)	10 units at 25oC	22880
PB-E-GALCJ	<i>endo</i> -1,4- β -Galactanase (<i>Cellvibrio japonicus</i>)	1,500 units	34528
PB-E-GALCT	<i>endo</i> -1,4- β -Galactanase (<i>Clostridium thermocellum</i>)	350 units at 40oC; ~ 770 units at 60oC	34528
PB-E-GALDH	Galactose dehydrogenase (soil prokaryote)	200 units	34528
PB-E-GALMUT	Galactose dehydrogenase - Galactose mutarotase 1 mL; galactose dehydrogenase (200 U/mL) / galactose mutarotase (4 mg/mL)		40560
PB-E-GAMP	Glucoamylase P (<i>H. resinae</i>) (Recombinant)	340 units at 40oC; ~ 800 units at 60oC	32864
PB-E-GLUKEC	Gluconokinase (Gluconate kinase) (<i>E. coli</i>)	1,500 units	29952
PB-E-GLUTEC	Glutaminase (<i>E. coli</i>)	2,500 units	26624
PB-E-GMPK	Guanylate kinase (prokaryote)	500 units	35568
PB-E-GOTEC	Glutamate oxaloacetate transaminase (<i>E. coli</i>)	5,000 units	34528
PB-E-GOXA	Glucose oxidase - Catalase Mixture (eukaryote)	2 vials - 200 tests	21216
PB-E-GPDH5	Glucose-6-phosphate dehydrogenase (<i>Leuconostoc mesenteroides</i>)	5,000 units	31616
PB-E-GPDHEC	Glucose-6-phosphate dehydrogenase (<i>E. coli</i>)	5,000 units	29952
PB-E-GPO	Glycerol 3-phosphate oxidase	135 units	32864
PB-E-GPTBS	Glutamate pyruvate transaminase (<i>Bacillus subtilis</i>) (Recombinant)	2500 units	35568
PB-E-HBDH	3-Hydroxybutyrate dehydrogenase (prokaryote)	200 units	34528
PB-E-HEX10	Hexokinase (yeast)	10000 units	24544
PB-E-HKGDH	Hexokinase/Glucose-6-phosphate dehydrogenase	10 mL Hexokinase (420 U/ml) + G6P-DH (210 U/ml)	28704
PB-E-HYLSP	Hyaluronate lyase (novel specificity) (soil prokaryote)	100 units	22880
PB-E-ICDHBS	Isocitrate dehydrogenase (<i>Bacillus subtilis</i>)	2000 units	33280
PB-E-INDHBS	Isocitrate dehydrogenase (<i>Bacillus subtilis</i>)	500 units	27664
PB-E-INVDP-2G	Invertase Powder	2 g	20800
PB-E-INVDP-5G	Invertase Powder	5 g	41392

Product Code	Description	Pack Size	Price
PB-E-INVRT	Invertase (fructofuranosidase) (yeast)	100 mL; 200,000 units.	
PB-E-ISAMY	Isoamylase (Glycogen 6-glucanohydrolase)	2,000 U/mL	28496
PB-E-ISAMYHP	Isoamylase HP (Glycogen 6-glucanohydrolase)	600 units	41600
PB-E-ISPUAN	Isopullulanase (<i>Aspergillus niger</i>)	200 Units	23205
PB-E-ISPAN	Isopullulanase (<i>Aspergillus niger</i>)	2,000 units at 40oC	32864
PB-E-LAMHV	<i>endo</i> -1,3- β -D-Glucanase (barley) (<i>Recombinant</i>)	5000 units	32864
PB-E-LAMSE	<i>endo</i> -1,3- β -D-Glucanase (<i>Trichoderma</i> sp.)	100 units	28496
PB-E-LICACT	Non-specific <i>endo</i> -1,3(4)- β -Glucanase (<i>Clostridium thermocellum</i>)	5000 units	45760
PB-E-LICHN	Lichenase (<i>endo</i> -1,3:1,4- β -D-Glucanase) (<i>Bacillus subtilis</i>)	5000 units	48880
PB-E-LLDHP	L-Lactate dehydrogenase (Porcine)	6000 units	22880
PB-E-LMDHEC	L-Malate dehydrogenase (<i>E. coli</i>)	50,000 units	27248
PB-E-MAL6M	Glucan 1,4- α -maltohexaosidase	2000 units	31824
PB-E-MALBS	Oligo- α -(1,4-1,6)-glucosidase (<i>Bacillus</i> sp.)	3000 units	31824
PB-E-MALTS	α -Glucosidase (yeast maltase)	2000 units	30992
PB-E-MAST	Malt Amylase Standard 100 mL; α -amylase 950 U/mL; β -amylase 5700 U/mL.		20800
PB-E-MNHHPF	Mannitol dehydrogenase (<i>Pseudomona fluorescens</i>)	500 units	27664
PB-E-NADHPO	Peroxidase (NADH peroxidase) (<i>Enterococcus faecalis</i>)	1000 units	34944
PB-E-OAGUM	Oligo- α -1,6-Glucosidase (microbial)	3000 units	32864
PB-E-OGLYEF	<i>endo</i> - α -N-Acetylgalactosaminidase (<i>Enterococcus faecalis</i>)	100 munits	39312
PB-E-PANAA-3G	α -Amylase (Porcine Pancreatic)	3 g	22880
PB-E-PANAA-9G	α -Amylase (Porcine Pancreatic)	9 g	59488
PB-E-PCLYAN	Pectate Lyase (<i>Aspergillus</i> sp.)	7,000 units in 50% aqueous glycerol	28496
PB-E-PCLYAN2	Pectate Lyase (<i>Aspergillus</i> sp.)	7,500 units in 3.2 M ammonium sulphate	28496
PB-E-PGALUSP	<i>endo</i> -Polygalacturonanase M2 (<i>Aspergillus aculeatus</i>)	5,000 units	28496
PB-E-PGDHEC	6-Phosphogluconate dehydrogenase (<i>E. coli</i>)	150 units	34528
PB-E-PGIBS-50KU	Phosphoglucose isomerase (<i>Bacillus subtilis</i>)	50,000 units	134992
PB-E-PGIBS-5KU	Phosphoglucose isomerase (<i>Bacillus subtilis</i>)	5,000 units	20176
PB-E-PGIEC-10KU	Phosphoglucose isomerase (<i>E. coli</i>)	10,000 units	27040
PB-E-PGIEC-50KU	Phosphoglucose isomerase (<i>E. coli</i>)	50,000 units	105040
PB-E-PGISC-50KU	Phosphoglucose isomerase (<i>Saccharomyces cerevisiae</i>)	50,000 units	175552
PB-E-PGISC-5KU	Phosphoglucose isomerase (<i>Saccharomyces cerevisiae</i>)	5,000 units	29120
PB-E-PGM	Mutase (α -Phosphoglucomutase) (microbial)	3,000 units	32864
PB-E-PKRM	Pyruvate kinase (rabbit muscle)	5,000 units at 37oC	31824
PB-E-PLYCJ	Pectate lyase (<i>Cellvibrio japonicus</i>)	2,500 units	32448
PB-E-PMIEC	Phosphomannose isomerase (<i>E. coli</i>)	1,000 units	29536
PB-E-PROTOF	Protoplast F	2.5 mL	31824
PB-E-PTABS	Phosphotransacetylase (<i>Bacillus subtilis</i>)	3,000 units	29952
PB-E-PULBL	Pullulanase M2 (<i>Bacillus licheniformis</i>)	2,000 units	30992
PB-E-PULKP	Pullulanase M1 (<i>Klebsiella planticola</i>)	700 units	30992
PB-E-RHAMS	α -Rhamnosidase (prokaryote)	3,000 units at 50oC	32864
PB-E-SCOAS	Succinyl-CoA synthetase (prokaryote)	550 units	34528
PB-E-SIALCP	<i>exo</i> - α -Sialidase (<i>Clostridium perfringens</i>)	5 units	39312
PB-E-SIALST	<i>exo</i> - α -Sialidase (<i>Salmonella typhimurium</i>)	250 units	32864
PB-E-SUCR	Sucrase (Maltase from yeast)	300 units (on sucrose)	35568
PB-E-SUCRBG	Sucrase plus β -Galactosidase	170 U Sucrase plus 3,000 U β -Galactosidase	30576
PB-E-TMPK	Thymidylate kinase (prokaryote)	150 units	35568
PB-E-TREH	Trehalase (prokaryote)	8,400 units	22880
PB-E-TRNGL	α -Glucosidase (transglucosidase) (<i>Aspergillus niger</i>)	2,000 units	28496
PB-E-TSAGL	α -Glucosidase (<i>Bacillus stearothermophilus</i>)	1,500 units	28496
PB-E-TSAGS	α -Glucosidase (<i>Bacillus stearothermophilus</i>) (Recombinant)	3,000 units at 40oC; ~ 6,000 units at 60oC	32864
PB-E-UAO	Uricase (eukaryote)	300 units	26208
PB-E-XANLB	Xanthan lyase (<i>Bacillus</i> sp.)	20,000 units	32864

Product Code	Description	Pack Size	Price
PB-E-XEGP	Xyloglucanase (GH5) (<i>Paenibacillus</i> sp.)	3000 units	32864
PB-E-XGP74	Xyloglucanase (GH74) (<i>Paenibacillus</i> sp.)	200 units	32864
PB-E-XYAN4	endo-1,4- β -Xylanase M4 (<i>Aspergillus niger</i>)	8000 units	30992
PB-E-XYLAA	endo-1,4- β -Xylanase (<i>Aspergillus aculeatus</i>)	3.125 mL; 5,000 units	30992
PB-E-XYLATM	endo-1,4- β -Xylanase (<i>Thermotoga maritima</i>)	7500 units	34528
PB-E-XYLMUT	Xylose dehydrogenase + Xylose mutarotase 2.5 mL; xylose dehydrogenase (60 U/mL) / xylose mutarotase (2mg/mL)		32864
PB-E-XYLNP	endo-1,4- β -Xylanase (<i>Aeromonas punctata</i>)	20000 units	34528
PB-E-XYNACJ	endo-1,4- β -Xylanase (<i>Cellvibrio japonicus</i>)	500 units	34528
PB-E-XYNAP	endo-1,4- β -Xylanase (<i>Aeromonas punctata</i>)	40 units	34528
PB-E-XYNBCM	endo-1,4- β -Xylanase (<i>Cellvibrio mixtus</i>)	1500 units	34528
PB-E-XYNBS	endo-1,4- β -Xylanase (<i>Bacillus stearothermophilus</i> T6)	2000 units	32864
PB-E-XYRU6	endo-1,4- β -Xylanase (rumen microorganism)	8000 units	30992
PB-E-XYTR1	endo-1,4- β -Xylanase M1 (<i>Trichoderma viride</i>)	8000 units	30992
PB-E-XYTR3	endo-1,4- β -Xylanase M3 (<i>Trichoderma longibrachiatum</i>)	8000 units	30992
PB-G-AMBH	Ambersep 200 H ⁺ Ion Exchange Resin	2.5 Kg	26832
PB-G-AMBOH	Amberlite FPA OH ⁻ Ion Exchange Resin	2.5 Kg	27664
PB-G-CEL-100G	Celite	100g	12688
PB-G-CEL-500G	Celite	500g	33488
PB-G-LCYST200	L-Cysteine Hydrochloride Monohydrate	200 g	22880
PB-I-AAVIC	Azo-Avicel	10 g	28496
PB-I-ACELL	Azo- α -Cellulose	10 g	28496
PB-I-AZAMY	AZCL-Amylose	5g	28496
PB-I-AZAMYF	AZCL-Amylose (fine)	5g	28496
PB-I-AZBGL	AZCL-Barley β -Glucan	3g	33488
PB-I-AZBGLF	AZCL-Barley β -Glucan (fine)	3g	33488
PB-I-AZCAS	AZCL-Casein	4g	30992
PB-I-AZCEL	AZCL-HE-Cellulose	3g	30368
PB-I-AZCELF	AZCL-HE-Cellulose (fine)	3g	30368
PB-I-AZCHAN	AZCL-Chitosan	4g	25792
PB-I-AZCHANF	AZCL-Chitosan (fine)	4g	25792
PB-I-AZCOL	AZCL-Collagen	4g	30992
PB-I-AZCUR	AZCL-Curdlan	3g	28496
PB-I-AZCURF	AZCL-Curdlan (fine)	3g	28496
PB-I-AZDAR	AZCL-Arabinan (Debranched)	3g	33488
PB-I-AZDEX	AZCL-Dextran (No. B-512)	3g	23504
PB-I-AZDEXF	AZCL-Dextran (No. B-512) (fine)	3g	23504
PB-I-AZGLP	AZCL-Galactan (Potato)	3g	33488
PB-I-AZGLPF	AZCL-Galactan (Potato) (fine)	3g	33488
PB-I-AZGMA	AZCL-Galactomannan (Carob)	3g	30992
PB-I-AZGMAF	AZCL-Galactomannan (Carob) (fine)	3g	30992
PB-I-AZPAC	AZCL-Pachyman	3g	28496
PB-I-AZPUL	AZCL-Pullulan	3g	28496
PB-I-AZPULF	AZCL-Pullulan (fine)	3g	28496
PB-I-AZRHI	AZCL-Rhamnogalacturonan I	2g	42432
PB-I-AZWAX	AZCL-Arabinoxylan (Wheat)	3g	30992
PB-I-AZWAXF	AZCL-Arabinoxylan (Wheat) (fine)	3g	30992
PB-I-AZXBE	AZCL-Xylan (Beechwood)	4g	27872
PB-I-AZXBW	AZCL Xylan (Birchwood)	4g	28496
PB-I-AZXYG	AZCL-Xyloglucan (Tamarind)	4g	30992
PB-I-AZXYGF	AZCL-Xyloglucan (Tamarind) (fine)	4g	30992
PB-I-RCLAMYF	RedCL-Amylose (fine)	5g	28496
PB-I-RCLBGLF	RedCL-Barley β -Glucan (fine)	3g	33488
PB-I-RCLCELF	RedCL-HE-Cellulose (fine)	3g	30368
PB-I-RCLCURF	RedCL-Curdlan (fine)	3g	28496
PB-I-RCLGMAF	RedCL-Galactomannan (Carob) (fine)	3g	30992
PB-I-RCLPULF	RedCL-Pullulan (fine)	3g	28496
PB-I-RCLWAXF	RedCL-Arabinoxylan (Wheat) (fine)	3g	30992

Product Code	Description	Pack Size	Price
PB-I-RCLXYGF	RedCL-Xyloglucan (Tamarind) (fine)	4g	30992
PB-K-ACET	Acetic Acid Assay Kit (ACS Manual Format)	53 assays per kit	30784
PB-K-ACETAF	Acetic Acid Assay Kit (ACS Analyser Format) 141.6 mL of prepared reagent (e.g. 456 assays of 0.31 mL)		30992
PB-K-ACETAK	Acetic Acid Assay Kit (Acetate Kinase Analyser Format) 170.5 mL of prepared reagent (e.g. 550 assays of 0.31 mL)		34528
PB-K-ACETGK	Acetic Acid GK Assay Kit (Analyser Format) 110 mL of prepared reagent (e.g. 500 assays of 0.22 mL)		30576
PB-K-ACETRM	Acetic Acid Assay Kit (Acetate Kinase Manual Format) 72 assays (manual) / 720 assays (microplate)		36608
PB-K-ACHDF	Available Carbohydrates/Dietary Fiber Assay Kit	100 assays of each component	57408
PB-K-ACHYD	Acetaldehyde Assay Kit 50 assays (manual) / 500 assays (microplate) / 500 assays (auto-analyser)		25584
PB-K-AGLUA	α -Glucuronidase Assay Kit 50 assays (manual) / 200 assays (microplate)		41600
PB-K-AMIAR	Ammonia Assay Kit (Rapid) 96 assays (manual) / 960 assays (microplate) / 960 assays (auto-analyser)		27248
PB-K-AMYL	Amylose/Amylopectin Assay Kit	100 assays per kit	56368
PB-K-AMYLS	α -Amylase SD Assay Kit (High Sensitivity Method)	160 / 320 assays (manual) / 640 assays (auto-analyser)	53040
PB-K-ARAB	Arabinan Assay Kit	100 assays per kit	50336
PB-K-ARGA	L-Arabinose/D-Galactose Assay Kit 115 assays (manual) / 1150 assays (microplate) / 1150 assays (auto-analyser)		43680
PB-K-ASCO	Ascorbic Acid Assay Kit (L-Ascorbate) 40 assays (manual) / 400 assays (microplate) / 400 assays (auto-analyser)		25168
PB-K-ASNAM	L-Asparagine/L-Glutamine/Ammonia Assay Kit (Rapid)	100 assays (50 of each) per kit	39104
PB-K-ASPTM	Aspartame Assay Kit 50 assays (manual) / 500 assays (microplate) / 500 assays (auto-analyser)		34528
PB-K-AZOWAX	Xylanase Assay Kit (Azo-Wax)	200 assays per kit	56368
PB-K-BETA3	β -Amylase Assay (Betamyl-3)	100 / 200 assays per kit	45760
PB-K-BGLU	β -Glucan Assay Kit (Mixed Linkage)	100 assays per kit	45136
PB-K-CATAL	Catalase Assay Kit	100 / 200 assays per kit	42432
PB-K-CELLG3	Cellulase Assay Kit (CellG3 Method) 180 / 360 assays per kit / 720 (auto-analyser)		65520
PB-K-CELLG5-2V	Cellulase Assay Kit (CellG5 Method) 120 / 240 assays (manual) / 480 (auto-analyser) / 60 / 120 assays (manual) / 240 (auto-analyser)		46410
PB-K-CELLG5-4V	Cellulase Assay Kit (CellG5 Method)	120 / 240 assays (manual) / 480 (auto-analyser) / 60 / 120 assays (manual) / 240 (auto-analyser)	69615
PB-K-CERA	α -Amylase Assay Kit (Ceralpha Method)	100 / 200 assays per kit	45136
PB-K-CITR	Citric Acid Assay Kit	72 assays (manual) / 720 assays (microplate) / 840 assays (auto-analyser)	32032
PB-K-DATE	D-Lactic Acid (D-Lactate) (Rapid) Assay Kit	50 assays (manual) / 500 assays (microplate) / 450 assays (auto-analyser)	34528
PB-K-DLATE	D-/L-Lactic Acid (D-/L-Lactate) (Rapid) Assay Kit	100 assays (50 of each) per kit	60528
PB-K-DMAL	D-Malic Acid Assay Kit	100 assays (manual) / 1000 assays (microplate) / 1100 assays (auto-analyser)	39728
PB-K-EBHLG	Enzymatic Yeast β -Glucan Assay Kit	50 assays per kit	43680
PB-K-ETOH	Ethanol Assay Kit	60 assays (manual) / 600 assays (microplate) / 600 assays (auto-analyser)	26624
PB-K-ETSULPH	Total Sulfite Assay Kit (Enzymatic)	50 assays (manual) / 500 assays (microplate) / 588 assays (auto-analyser)	34944

Product Code	Description	Pack Size	Price
PB-K-FORM	Formic Acid Assay Kit	25 assays (manual) / 250 assays (microplate) / 220 assays (auto-analyser)	29952
PB-K-FRGLMQ	The D-Fructose and D-Glucose Assay Kit (MegaQuant™ Format)	60 assays per kit	34528
PB-K-FRGLQR	D-Fructose/D-Glucose Assay Kit (Liquid Ready Reagents)	1100 assays (microplate) / 1100 assays (auto-analyser)	32864
PB-K-FRUC	Fructan Assay Kit	100 assays per kit	56875
PB-K-FRUCHK	Fructan HK Assay Kit	50 assays per kit	53040
PB-K-FRUGL	D-Fructose/D-Glucose Assay Kit	110 assays (manual) / 1100 assays (microplate) / 1100 assays (auto-analyser)	36816
PB-K-FSULPH	Free Sulphite Assay kit	80 assays (manual) / 800 assays (microplate) / 800 assays (auto-analyser)	27456
PB-K-FUCOSE	L-Fucose Assay Kit	100 assays (manual) / 1000 assays (microplate) / 1020 assays (auto-analyser)	34944
PB-K-GALM	Galactomannan Assay Kit	100 Assays per kit	53040
PB-K-GAMINE	D-Glucosamine Assay Kit	50 assays (manual) / 500 assays (microplate) / 500 assays (auto-analyser)	32032
PB-K-GATE	D-Gluconate Acid/D-Glucono- δ -lactone Assay Kit	60 assays (manual) / 600 assays (microplate) / 600 assays (auto-analyser)	44304
PB-K-GCROL	Glycerol Assay Kit	70 assays (manual) / 700 assays (microplate)	23504
PB-K-GCROLGK	Glycerol GK Assay Kit	70 assays (manual) / 700 assays (microplate) / 600 assays (auto-analyser)	23504
PB-K-GLNAM	L-Glutamine/Ammonia Assay Kit (Rapid)	50 assays of each (manual) / 500 assays of each (microplate)	36608
PB-K-GLOX	Glucose Oxidase Assay Kit	200 assays (manual) / 2000 assays (microplate) / 1960 assays (auto-analyser)	29120
PB-K-GLUC	D-Glucose Assay Kit (GOPOD Format)	660 assays per kit	38480
PB-K-GLUHK-110A	D-Glucose HK Assay Kit	220 assays (manual) / 2200 (microplate) / 2000 (auto-analyser) / 110 assays (manual) / 1100 (microplate) / 1000 (auto-analyser)	29328
PB-K-GLUHK-220A	D-Glucose HK Assay Kit	220 assays (manual) / 2200 (microplate) / 2000 (auto-analyser) / 110 assays (manual) / 1100 (microplate) / 1000 (auto-analyser)	50544
PB-K-GLUM	Glucomannan Assay Kit	50 Assays per kit	54912
PB-K-GLUT	L-Glutamic Acid Assay Kit	60 assays (manual) / 600 assays (microplate) / 700 assays (auto-analyser)	23504
PB-K-HDBA	D-3-Hydroxybutyric Acid Assay Kit	60 assays (manual) / 600 assays (microplate) / 740 assays (auto-analyser)	32032
PB-K-INOSL	<i>myo</i> -Inositol Assay Kit	50 assays per kit	41600
PB-K-INTDF	Integrated Total Dietary Fiber Assay Kit	100 assays per kit	45760

Product Code	Description	Pack Size	Price
PB-K-ISOC	D-Isocitric Acid Assay Kit	100 assays (manual) / 1000 assays (microplate) / 1000 assays (auto-analyser)	29328
PB-K-LACGAR	Lactose/Galactose Assay Kit (Rapid)	115 assays per kit	62400
PB-K-LACSU	Lactose/Sucrose/D-Glucose Assay Kit	100 assays of each per kit	46384
PB-K-LACTUL	Lactulose Assay Kit	50 assays per kit	40352
PB-K-LARGE	L-Arginine/Urea/Ammonia Assay Kit	50 Assays per kit	34528
PB-K-LATE	L-Lactic Acid (L-Lactate) Assay Kit	50 assays (manual) / 500 assays (microplate) / 450 assays (auto-analyser)	22880
PB-K-LMAL-116A	L-Malic Acid Assay Kit (Manual Format)	58 assays (manual) / 580 (microplate) / 116 assays (manual) / 1160 (microplate)	37440
PB-K-LMAL-58A	L-Malic Acid Assay Kit (Manual Format)	58 assays (manual) / 580 (microplate) / 116 assays (manual) / 1160 (microplate)	22048
PB-K-LMALAF	L-Malic Acid Assay Kit (Analyser Format)	245.5 mL of prepared reagent (e.g. 1116 assays of 0.22 mL)	38064
PB-K-LMALMQ	L-Malic Acid Assay Kit (MegaQuant™ Format)	60 assays per kit	34528
PB-K-LMALQR	L-Malic Acid Assay Kit (Liquid Ready Reagents)	1100 assays (microplate) / 1100 (auto-analyser)	31824
PB-K-LOLAC	Lactose Assay Kit	65 assays per kit	58240
PB-K-MALTA	Malt Amylase Assay Kit	100 assays (50 of each) per kit	48464
PB-K-MANGL	D-Mannose/D-Fructose/D-Glucose Assay kit	55 assays per kit	40352
PB-K-MANOL	D-Mannitol/L-Arabitol Assay Kit	60 assays (manual) / 600 assays (microplate) / 580 assays (auto-analyser)	42016
PB-K-MASUG	Maltose/Sucrose/D-Glucose Assay Kit	100 assays (34 of each) per kit	39520
PB-K-MBG4	Malt β -Glucanase/Lichenase Assay Kit (MBG4 Method)	100 assays (manual) / 400 assays (auto-analyser)	48880
PB-K-MBGL	β -Glucanase Assay Kit (Malt and Microbial)	100 assays per kit	42432
PB-K-PANOPA	Primary Amino Nitrogen Assay Kit (PANOPA)	100 assays (manual) / 1000 assays (microplate) / 1100 assays (auto-analyser)	25168
PB-K-PECID	Pectin Identification Assay Kit	500 assays per kit	51168
PB-K-PHYT	Phytic Acid (Total Phosphorus) Assay Kit	50 assays per kit	29952
PB-K-PULLG6	Pullulanase/Limit-Dextrinase Assay Kit (PullG6 Method)	100/200 assays per kit	53040
PB-K-PYRUV	Pyruvic Acid Assay Kit	100 assays (manual) / 1000 assays (microplate) / 1000 assays (auto-analyser)	27664
PB-K-RAFGA	Raffinose/D-Galactose Assay Kit	120 assays per kit	50544
PB-K-RAFGL	Raffinose/Sucrose/D-Glucose Assay Kit	120 assays of each per kit	50544
PB-K-RHAMNOSE	L-Rhamnose Assay Kit	50 / 100 assays (manual) / 550 assays (microplate) / 550 assays (auto-analyser)	32864
PB-K-RINTDF	Rapid Integrated Total Dietary Fiber Assay Kit	100 assays per kit	53040
PB-K-RSTAR	Resistant Starch Assay Kit	100 assays per kit	45136
PB-K-RSTCL	Resistant Starch Control Flours	5 Controls per kit	28496
PB-K-SDAM	Starch Damage Assay Kit	200 assays per kit	45136
PB-K-SORB	D-Sorbitol/Xylitol Assay Kit	58 assays (manual) / 580 assays (microplate) / 700 assays (auto-analyser)	38480

Product Code	Description	Pack Size	Price
PB-K-SUCC	Succinic Acid Assay Kit	20 assays (manual) / 200 assays (microplate) / 270 assays (auto-analyser)	35984
PB-K-SUCGL	Sucrose/D-Glucose Assay Kit	250 assays per kit	43888
PB-K-SUFRG	Sucrose/D-Fructose/D-Glucose Assay Kit	300 assays (100 of each) per kit	39728
PB-K-SULPH	Total and Free Sulfite Assay Kit	40 assays (manual) / 400 assays (microplate) / 400 assays (auto-analyser)	27456
PB-K-TART	Tartaric Acid Assay Kit	200 assays (manual) / 2000 assays (microplate) / 2000 assays (auto-analyser)	34944
PB-K-TDFC	Total Dietary Fiber Controls	Sufficient for 6 Controls	45136
PB-K-TDFR-100A	Total Dietary Fiber Assay Kit	100 assays / 200 assays	38272
PB-K-TDFR-200A	Total Dietary Fiber Assay Kit	100 assays / 200 assays	61568
PB-K-TREH	Trehalose Assay Kit	100 assays (manual) / 1000 assays (microplate) / 1100 assays (auto-analyser)	45760
PB-K-TSCK	Total Starch Control Flours	5 Controls per kit	28496
PB-K-TSHK	Total Starch HK Assay Kit	100 assays per kit	54704
PB-K-TSTA-100A	Total Starch Assay Kit (AA/AMG)	50 assays / 100 assays	49712
PB-K-TSTA2-100A	Total Starch Assay Kit (AA/AMG)	50 assays / 100 assays	48672
PB-K-TSTA-50A	Total Starch Assay Kit (AA/AMG)	50 assays / 100 assays	30784
PB-K-TSULPH	Total Sulfite Assay Kit	80 assays (manual) / 800 assays (microplate) / 800 assays (auto-analyser)	27456
PB-K-URAMR	Urea/Ammonia Assay Kit (Rapid)	100 assays (50 of each) per kit	32864
PB-K-URONIC	D-Glucuronic/D-Galacturonic Acid Assay Kit	100 assays (manual) / 1000 assays (microplate) / 1000 assays (auto-analyser)	41600
PB-K-XYLOSE	D-Xylose Assay Kit	100 assays (manual) / 1000 assays (microplate) / 1300 assays (auto-analyser)	45136
PB-K-XYLS	Xylanase Assay Kit (Xylazyme AX)	200 assays per kit	56368
PB-K-XYLX6-1V	<i>endo</i> -Xylanase Assay Kit (XylX6 Method)	100 assays (manual) / 200 assays (auto-analyser) / 200 assays (manual) / 400 assays (auto-analyser)	42432
PB-K-XYLX6-2V	<i>endo</i> -Xylanase Assay Kit (XylX6 Method)	100 assays (manual) / 200 assays (auto-analyser) / 200 assays (manual) / 400 assays (auto-analyser)	63648
PB-K-YBGL	β -Glucan Assay Kit (Yeast & Mushroom)	100 assays per kit	45136
PB-L-CONA-1000MG	Concanavalin A (Con A)	1000 mg	54704
PB-L-CONA-200MG	Concanavalin A (Con A)	200 mg	16224
PB-O-4MUAM2	4-Methylumbelliferyl- α -mannobioside	20 mg	54704
PB-O-4MUAM3	4-Methylumbelliferyl- α -mannotrioside	20 mg	54704
PB-O-4MUAM4	4-Methylumbelliferyl- α -mannotetraoside	10 mg	54704
PB-O-4MUBG3	4-Methylumbelliferyl- β -(1,3:1,4)-glucotrioside	10 mg	53040
PB-O-4MUG2	4-Methylumbelliferyl- β -cellobioside	200 mg	32864
PB-O-4MUG3	4-Methylumbelliferyl- β -cellotrioside	20 mg	87360
PB-O-4MUG4	4-Methylumbelliferyl- β -cellotetraoside	15 mg	87360
PB-O-4MUG5	4-Methylumbelliferyl- β -cellopentaoside	10 mg	87360
PB-O-4MULAM2	4-Methylumbelliferyl- β -laminaribioside	15 mg	63648
PB-O-4MULAM3	4-Methylumbelliferyl- β -laminaritrioside	10 mg	63648
PB-O-4MULAM4	4-Methylumbelliferyl- β -laminaritetraoside	5 mg	63648

Product Code	Description	Pack Size	Price
PB-O-4MUNAG	4-Methylumbelliferyl-β-N-acetyl-D-glucosaminide	200 mg	25376
PB-O-4MUX2-10MG	4-Methylumbelliferyl-β-xylobioside	10 mg	43680
PB-O-4MUX2-5MG	4-Methylumbelliferyl-β-xylobioside	5 mg	26208
PB-O-4MUX3	4-Methylumbelliferyl-β-xylotrioside	10 mg	54704
PB-O-A23XX-30MG	23,33-di-α-L-Arabinofuranosyl-xylotriose (A2+3XX)	30 mg	32864
PB-O-A23XX-50MG	23,33-di-α-L-Arabinofuranosyl-xylotriose (A2+3XX)	50 mg	42432
PB-O-A2XX	23-α-L-Arabinofuranosyl-xylotriose (A2XX)	30 mg	30576
PB-O-A3X	32-α-L-Arabinofuranosyl-xylobiose (A3X)	10 mg	26208
PB-O-A4B	32-α-L-Arabinofuranosyl-(1,5)-α-L-arabinotriose	20 mg	24752
PB-O-A5BMIX	22,32-di-α-L-Arabinofuranosyl-(1,5)-α-L-arabinotriose plus 32-α-L-arabinofuranosyl-(1,5)-α-L-arabinotetraose	20 mg	24752
PB-O-ABI	Arabinobiose	50 mg	30784
PB-O-AHE	Arabinohexaose	20 mg	24752
PB-O-AHP	Arabinoheptaose	15 mg	24752
PB-O-AMX	Aldouronic Acids Mixture	200 mg	30784
PB-O-AMXR	Aldouronic Acids Mixture (NaBH4 Reduced)	100 mg	30784
PB-O-AOC	Arabino-octaose	10 mg	24752
PB-O-APE	Arabinopentaose	30 mg	30784
PB-O-ATE	Arabinotetraose	30 mg	30784
PB-O-ATR	Arabinotriose	50 mg	30784
PB-O-B4MUG3	Blocked 4-methylumbelliferyl-β-cellobioside	5 mL of 10mM substrate in DMSO (37.5 mg)	109200
PB-O-BGTETB	3 ¹ -β-D-Cellobiosyl-glucose	40 mg	32032
PB-O-BGTETC	3 ² -β-D-Cellobiosyl-cellobiose + 3 ³ -β-D-Glucosyl-cellobiose	30 mg	32032
PB-O-BGTRIA	3 ² -β-D-Glucosyl-cellobiose	50 mg	32032
PB-O-BGTRIB	3 ¹ -β-D-Cellobiosyl-glucose	50 mg	32032
PB-O-BNAPG3	Blocked β-naphthyl-β-cellobioside	5 mL of 10mM substrate in DMSO (35.9 mg)	109200
PB-O-BNPC7	Blocked 4-nitrophenyl-α-maltoheptaoside	4 vials	51168
PB-O-CHE	Cellohexaose	10 mg	29744
PB-O-CHERD	1,4-β-D-Cellohexaitol (borohydride reduced cellohexaose)	10 mg	29744
PB-O-CHI2	Diacetyl-chitobiose	30 mg	41392
PB-O-CHI3	Triacetyl-chitotriose	30 mg	41392
PB-O-CHI4	Tetraacetyl-chitotetraose	20 mg	41392
PB-O-CHI5	Pentaacetyl-chitopentaose	20 mg	41392
PB-O-CHI6	Hexaacetyl-chitohexaose	10 mg	34528
PB-O-CNPBG3	2-Chloro-4-nitrophenyl-β-(1,3:1,4)-glucotriose	20 mg	53040
PB-O-CNPBG4	2-Chloro-4-nitrophenyl-β-(1,3:1,4)-glucotetraoside	20 mg	53040
PB-O-CPE-20MG	Cellopentaose	20 mg	26624
PB-O-CPE-50MG	Cellopentaose	50 mg	54912
PB-O-CPERD	1,4-β-D-Cellopentaaitol (borohydride reduced cellopentaose)	30 mg	34528
PB-O-CPNPAM2	2-Chloro-4-nitrophenyl-α-mannobioside	20 mg	54704
PB-O-CPNPAM3	2-Chloro-4-nitrophenyl-α-mannotriose	20 mg	54704
PB-O-CPNPAM4	2-Chloro-4-nitrophenyl-α-mannotetraoside	10 mg	54704
PB-O-CPNPG2-100	2-Chloro-4-nitrophenyl-β-cellobioside	100 mg	54704
PB-O-CPNPG3-50	2-Chloro-4-nitrophenyl-β-cellobioside	50 mg	54704
PB-O-CPNPG4-50	2-Chloro-4-nitrophenyl-β-cellobioside	50 mg	65520
PB-O-CPNPG5	2-Chloro-4-nitrophenyl-β-cellobioside	10 mg	65520
PB-O-CTE-100MG	Cellotetraose	100 mg	56992
PB-O-CTE-50MG	Cellotetraose	50 mg	34528
PB-O-CTERD	1,4-β-D-Cellotetraitol (borohydride reduced cellotetraose)	50 mg	34528
PB-O-CTR-100MG	Cellotriose	100 mg	56992
PB-O-CTR-50MG	Cellotriose	50 mg	34528
PB-O-CTRRD	1,4-β-D-Cellotriitol (borohydride reduced cellotriose)	50 mg	34528

Product Code	Description	Pack Size	Price
PB-O-GBI3	1,3-β-D-Galactobiose	2 mg	37440
PB-O-GBI4-20MG	1,4-β-D-Galactobiose	20 mg	31200
PB-O-GBI4-50MG	1,4-β-D-Galactobiose	50 mg	58240
PB-O-GBI6	1,6-β-D-Galactobiose	10 mg	33280
PB-O-GENT	Gentiobiose	100 mg	21216
PB-O-GGM	1,4-β-D-Cellobiosyl-D-Mannose	30 mg	30160
PB-O-GGM5	6 ³ , 6 ⁴ -α-D-Galactosyl-mannopentaose	50 mg	30784
PB-O-GM	1,4-β-D-Glucosyl-D-Mannose	30 mg	30160
PB-O-GM3	6 ¹ -α-D-Galactosyl-mannotriose	20 mg	30784
PB-O-GMH	6 ³ -α-D-Glucosyl-maltotriosyl-maltotriose	30 mg	19760
PB-O-GMM	1,4-β-D-Glucosyl-D-Mannobiose	30 mg	30160
PB-O-GMM3	6 ¹ -α-D-Galactosyl-mannobiose plus Mannotriose	100 mg	23504
PB-O-GMMBI	1,4-β-D-Glucosyl-D-Mannose plus 1,4-β-D-Mannobiose	50 mg	32864
PB-O-GMT	6 ³ -α-D-Glucosyl-maltotriose	50 mg	30784
PB-O-IMO2	Isomaltose	200 mg	25376
PB-O-IMO3	Isomaltotriose	200 mg	27664
PB-O-INU3	Inulotriose	30 mg	31200
PB-O-IPAN	Isopanose	100 mg	31824
PB-O-IPRM	Isoprimeverose (Xyloglucan Derived)	50 mg	30784
PB-O-KPE	1,1,1-Kestopentaose	40 mg	30784
PB-O-KTE	1,1-Kestotetraose	100 mg	30784
PB-O-KTR	1-Kestose	100 mg	30784
PB-O-LAC3	1,3-β-D-Galactosyl-D-glucose	2 mg	31200
PB-O-LAC6	Allolactose (1,6-β-D-Galactosyl-D-glucose)	5 mg	31200
PB-O-LAM2	Laminaribiose	50 mg	33488
PB-O-LAM3	Laminaritriose	50 mg	33488
PB-O-LAM4	Laminaritetraose	40 mg	30784
PB-O-LAM5	Laminaripentaose	30 mg	27872
PB-O-LAM5RD	1,3-β-D-Laminaripentaitol	10 mg	29744
PB-O-LAM6	Laminarihexaose	30 mg	27872
PB-O-MAL3	Maltotriose	5g	33904
PB-O-MAL4	Maltotetraose	100 mg	31824
PB-O-MBI	Mannobiose	50 mg	30784
PB-O-MGM	1,4-β-D-Mannosyl-1,4-β-D-Glucosyl-D-Mannose	20 mg	30160
PB-O-MHE	Mannohexaose	20 mg	24752
PB-O-MPE	Mannopentaose	30 mg	24752
PB-O-MTE	Mannotetraose	30 mg	30784
PB-O-MTMT	6 ³ -α-D-maltotriosyl-maltotriose	100 mg	39312
PB-O-MTMTRD	6 ³ -α-D-maltotriosyl-maltotriitol	100 mg	39312
PB-O-MTR	Mannotriose	50 mg	30784
PB-O-NAPC3-100	β-Naphthyl-β-maltotrioside	100 mg	43680
PB-O-ONPX2-25MG	2-Nitrophenyl-β-xylobioside	25 mg	48256
PB-O-ONPX2-5MG	2-Nitrophenyl-β-xylobioside	5 mg	32864
PB-O-PAN-1G	Panose	1 g	63648
PB-O-PAN-250MG	Panose	250 mg	21216
PB-O-PNPAF	4-Nitrophenyl-α-L-arabinofuranoside	100 mg	25376
PB-O-PNPAFC	4-Nitrophenyl-α-L-fucopyranoside	500 mg	23296
PB-O-PNPAG	4-Nitrophenyl-α-D-glucopyranoside	2g	19136
PB-O-PNPAGA	4-Nitrophenyl-α-D-glucuronide	25 mg	33904
PB-O-PNPAGAL	4-Nitrophenyl-α-D-galactopyranoside	1 g	19136
PB-O-PNPAGALA	4-Nitrophenyl-α-D-galacturonide	20 mg	40352
PB-O-PNPAM	4-Nitrophenyl-α-D-mannopyranoside	1g	21216
PB-O-PNPAX	4-Nitrophenyl-α-D-xylopyranoside	100 mg	21216
PB-O-PNPBG	4-Nitrophenyl-β-D-glucopyranoside	2 g	19136
PB-O-PNPBGA	4-Nitrophenyl-β-D-glucuronide	1 g	21216

Product Code	Description	Pack Size	Price
PB-O-PNPBGAL	4-Nitrophenyl-β-D-galactopyranoside	2g	19136
PB-O-PNPBGALA	4-Nitrophenyl-β-D-galacturonide	20 mg	33904
PB-O-PNPBPM	4-Nitrophenyl-β-D-mannopyranoside	100 mg	23296
PB-O-PNPC3-100	4-Nitrophenyl-β-maltotriose	100 mg	43680
PB-O-PNPCH2	4-Nitrophenyl-N,N'-diacetyl-β-chitobioside	10 mg	53040
PB-O-PNPL-100	4-Nitrophenyl-β-lactoside	100 mg	26208
PB-O-PNPLAM2	4-Nitrophenyl-β-laminaribioside	30 mg	63648
PB-O-PNPLAM3	4-Nitrophenyl-β-laminaritriose	20 mg	63648
PB-O-PNPLAM4	4-Nitrophenyl-β-laminaritetraose	10 mg	63648
PB-O-PNPAG	4-Nitrophenyl-β-N-acetyl-D-glucosaminide	1 g	25376
PB-O-PNPX	4-Nitrophenyl-β-D-xylopyranoside	1 g	38272
PB-O-PNPX2-10MG	4-Nitrophenyl-β-xylobioside	10 mg	23920
PB-O-PNPX2-50MG	4-Nitrophenyl-β-xylobioside	50 mg	77792
PB-O-PNPX3	4-Nitrophenyl-β-xylotriase	20 mg	54704
PB-O-SOPH	Sophorose	20 mg	29744
PB-O-UXXR	Aldotetrauronic acid (terminal substitution, borohydride reduced)	50 mg	29744
PB-O-VER	Verbascose	50 mg	30784
PB-O-X3G4	Heptasaccharide (X ₃ Glc ₄)	50 mg	30784
PB-O-X3G4R	Heptasaccharide (X ₃ Glc ₄ - borohydride reduced)	50 mg	30784
PB-O-XA3XX	3 ³ -α-L-Arabinofuranosyl-xyloetraose (XA ³ XX)	30 mg	33904
PB-O-XAXXMIX-10MG	3 ³ -α-L- plus 2 ³ -α-L-Arabinofuranosyl-xyloetraose (XA ³ XX/XA ² XX) mixture	10 mg	17056
PB-O-XAXXMIX-30MG	3 ³ -α-L- plus 2 ³ -α-L-Arabinofuranosyl-xyloetraose (XA ³ XX/XA ² XX) mixture	30 mg	33904
PB-O-XBI	Xylobiose	50 mg	30784
PB-O-XBIRD	1,4-β-D-Xylobiitol (borohydride reduced)	50 mg	30784
PB-O-XCBIR	Xylosyl-cellobiose (borohydride reduced)	50 mg	30784
PB-O-XGHDP	Higher Degree of Polymerisation Xyloglucan Oligosaccharides	100 mg	30784
PB-O-XGHON	Xyloglucan (hepta+octa+nona saccharides)	100 mg	33488
PB-O-XHE	Xylohexaose	10 mg	33488
PB-O-XPE	Xylopentaose	10 mg	24752
PB-O-XTE	Xyloetraose	30 mg	30784
PB-O-XTR	Xylotriase	50 mg	30784
PB-O-XTRRD	1,4-β-D-Xylotriitol (borohydride reduced)	50 mg	30784
PB-O-XUXXR	Aldopentaauronic acid (internal substitution, borohydride reduced)	50 mg	29744
PB-P-ADWAX22	Wheat Arabinoxylan (acid debranched, 22% Ara)	3 g	30992
PB-P-ADWAX26	Wheat Arabinoxylan (acid debranched, 26% Ara)	3 g	30992
PB-P-AMYL	Amylose (potato)	5g	31824
PB-P-ARAB	Arabinan (Sugar Beet)	8g	28080
PB-P-ARGAL	Arabinogalactan (Larch Wood)	25 g	25792
PB-P-BGBH	β-Glucan (Barley; High Viscosity)	4g	56368
PB-P-BGBL	β-Glucan (Barley; Low Viscosity)	5g	51168
PB-P-BGBM	β-Glucan (Barley; Medium Viscosity)	5g	53456
PB-P-BGCFA	β-Glucan CFA Standard	4 vials	33488
PB-P-BGOH	β-Glucan (Oat; High Viscosity)	5g	56368
PB-P-BGOM	β-Glucan (Oat; Medium Viscosity)	5g	51168
PB-P-BGYST	β-Glucan (Yeast; Alkali Soluble)	2g	34944
PB-P-BLDX-10G	β-Limit Dextrin	10 g	23920
PB-P-BLDX-50G	β-Limit Dextrin	50g	87360
PB-P-CHITN	Colloidal Chitin (Borohydride reduced)	1g	21216
PB-P-CMC4M	Carboxymethyl Cellulose 4M	40g	28496
PB-P-CMCUR	CM-Curdlan	4g	30992
PB-P-CMLA	CM-Linear 1,5-α-L-Arabinan (Sugar Beet)	2 vials	23712
PB-P-CMPAC	CM-Pachyman	4g	28496

Product Code	Description	Pack Size	Price
PB-P-CURDL	Curdlan	8g	28496
PB-P-DBAR	Debranched Arabinan (Sugar Beet)	2g	21424
PB-P-DEXT	Dextran	100 g	42432
PB-P-EDWAX30	Wheat Arabinoxylan (enzyme debranched, 30% Ara)	3g	30992
PB-P-FOS28	Fructooligosaccharides (FOS)	50g	21216
PB-P-GALLU	Galactan (Lupin)	3g	33488
PB-P-GALMH	Galactomannan (Carob; High Viscosity)	5g	30784
PB-P-GALML	Galactomannan (Carob; Low Viscosity)	4g	30784
PB-P-GALPOT	Galactan (Potato)	3g	33488
PB-P-GGM21	Galactomannan (Guar; High Visc, Gal depleted; 21% Gal)	4g	33488
PB-P-GGM28	Galactomannan (Guar; High Visc, Gal depleted; 28% Gal)	4g	33488
PB-P-GGMHV	Galactomannan (Guar; High Viscosity)	4g	30784
PB-P-GGMMV	Galactomannan (Guar; Medium Viscosity)	4g	30784
PB-P-GLCMH	Glucomannan (Konjac; High Viscosity)	3g	33488
PB-P-GLCML	Glucomannan (Konjac; Low Viscosity)	4g	28496
PB-P-INUL	Inulin	30 g	21216
PB-P-LARB	Linear 1,5- α -L-Arabinan (Sugar Beet)	500 mg	30992
PB-P-LICHN	Lichenan (Icelandic Moss)	4g	28496
PB-P-MANCB	Mannan (1,4- β -D-Mannan)	4g	30992
PB-P-MANIV	Mannan (Ivory Nut)	3g	30992
PB-P-MWBGS	β -Glucan MW Standard	6 X 500 mg	76752
PB-P-PACHY	Pachyman (1,3- β -D-Glucan)	5g	30784
PB-P-PGACT	Polygalacturonic Acid (PGA)	10 g	23296
PB-P-PGALU	Pectic Galactan (Lupin)	4g	28496
PB-P-PGAPT	Pectic Galactan (Potato)	4g	23504
PB-P-PULLBH	Pullulan (NaBH ₄ reduced)	5g	30992
PB-P-PULLN	Pullulan	10 g	28496
PB-P-RAXY	Arabinoxylan (Rye Flour)	3g	30992
PB-P-RHAGN	Rhamnogalacturonan (Soy Bean)	5g	25792
PB-P-RHAM1	Rhamnogalacturonan I (Potato)	2g	25792
PB-P-WAXYH	Arabinoxylan (Wheat Flour; High Viscosity ~ 43 cSt)	3g	35984
PB-P-WAXYI	Arabinoxylan (Wheat Flour; Insoluble)	5g	30992
PB-P-WAXYL	Arabinoxylan (Wheat Flour; Low Viscosity ~ 10 cSt)	3g	30992
PB-P-WAXYM	Arabinoxylan (Wheat Flour; Medium Viscosity ~ 30 cSt)	3g	30992
PB-P-WAXYRS	Arabinoxylan (Wheat Flour; for Reducing Sugar Assays)	10g	52000
PB-P-XANTH	Xanthan Gum	200 g	21216
PB-P-XYGLN	Xyloglucan (Tamarind)	3g	25792
PB-P-XYLNBE-10G	Xylan (Beechwood; purified)	10g	24960
PB-P-XYLNBE-50G	Xylan (Beechwood; purified)	50g	104000
PB-R-AMGR3	Amyloglucosidase Assay Reagent	200 assays per kit / 4 vials	58448
PB-R-AMHR4	Amylase HR Reagent	200 assays per kit / 4 vials	66976
PB-R-BAMR3	β -Amylase Assay Reagent (Betamyl-3)	200 / 400 assays per kit / 4 vials	68640
PB-R-CAAR4	α -Amylase Reagent (Ceralpha)	200 assays per kit / 4 vials	63648
PB-R-CELLFLR	Cellafluor Reagent	100 assays (manual) / 1000 assays (auto-analyser) / 1000 assays (microplate)	32864
PB-R-GLC4	Glucose Determination Reagent	1000 assays per kit / 4 vials	56368
PB-S-ABG100	Azo-Barley Glucan	100 mL (1% w/v)	33488
PB-S-ACGLM	Azo-Carob Galactomannan	4g	33488
PB-S-ACMC	Azo-CM-Cellulose (Powder)	4g	33488
PB-S-ACMCL	Azo-CM-Cellulose (Liquid)	100 mL (2% w/v)	30784
PB-S-AGALP	Azo-Galactan (Potato)	4g	35984
PB-S-AWAXL	Azo-Wheat Arabinoxylan (Liquid)	100 mL (1% w/v)	30992
PB-S-AWAXP	Azo-Wheat Arabinoxylan (Powder)	3g	42432
PB-S-AXBL	Azo-Xylan (Birchwood) (Liquid)	2 x 100 mL (1% w/v)	33488
PB-S-AXBP	Azo-Xylan (Birchwood) (Powder)	3g	37232
PB-S-AZCAS	Azo-Casein (Sulphanilamide Dyed)	10 g	30992

Product Code	Description	Pack Size	Price
PB-S-AZFR5	Azo-Fructan	5g	35984
PB-S-AZFRXOI	Azo-Fructan	2 grams + 4,000 units of pure exo-inulinase	35360
PB-S-AZRH	AZ-Rhamnogalacturonan	2g	42432
PB-S-AZYG	Azo-Xyloglucan (Tamarind)	4g	33488
PB-S-RDAR	Red Debranched Arabinan (Sugar Beet)	2g	28496
PB-S-RPUL	Red Pullulan	3g	37232
PB-S-RSTAR	Red Starch	5g	35568
PB-T-AMZ-1000T	Amylazyme Tablets	1,000 Tablets	141648
PB-T-AMZ-200T	Amylazyme Tablets	200 Tablets	38688
PB-T-AMZBG-200T	Amylazyme BG Tablets	200 Tablets	46800
PB-T-AMZHY-200T	Amylazyme HY Tablets	200 Tablets	38688
PB-T-AMZRD-1000T	Amylazyme Red Tablets	1,000 Tablets	169936
PB-T-AMZRD-200T	Amylazyme Red Tablets	200 Tablets	46800
PB-T-ARZ-200T	Arabinazyme Tablets	200 Tablets	49712
PB-T-BGZ-1000T	β -Glucazyme Tablets	1,000 tablets	157664
PB-T-BGZ-200T	β -Glucazyme Tablets	200 tablets	46800
PB-T-CAF-1000T	Cellazyme AF Tablets	1,000 Tablets	117936
PB-T-CCZ-1000T	Cellazyme C Tablets	1,000 Tablets	187200
PB-T-CCZ-200T	Cellazyme C Tablets	200 tablets	51168
PB-T-CHZ-200T	Chitozyme Tablets	200 Tablets	53040
PB-T-CTZ-1000T	Cellazyme T Tablets	1,000 Tablets	220480
PB-T-CTZ-200T	Cellazyme T Tablets	200 tablets	53664
PB-T-CUR-200T	1,3-Beta-Glucazyme HS Tablets	200 Tablets	50336
PB-T-DEXT-200T	Alpha-Dextrazyme Tablets	200 tablets	38688
PB-T-GLZ-1000T	Galactazyme Tablets	1,000 Tablets	179088
PB-T-GLZ-200T	Galactazyme Tablets	200 tablets	49712
PB-T-LDZ-1000T	Limit-Dextrizyme Tablets	1,000 Tablets	191152
PB-T-LDZ-200T	Limit-Dextrizyme Tablets	200 tablets	48464
PB-T-MNZ-1000T	Mannazyme Tablets	1,000 Tablets	205504
PB-T-MNZ-200T	Mannazyme Tablets	200 tablets	52416
PB-T-PAZ-200T	1,3- β -Glucazyme Tablets	200 tablets	49712
PB-T-PRAK-1000T	Protazyme AK Tablets	1,000 Tablets	205504
PB-T-PRAK-200T	Protazyme AK Tablets	200 tablets	52416
PB-T-PROL-1000T	Protazyme OL Tablets	1,000 Tablets	205504
PB-T-PROL-200T	Protazyme OL Tablets	200 tablets	52416
PB-T-PSYL-200T	Psyllazyme Tablets	200 tablets	42432
PB-T-RHAM-200T	Rhamnozime Tablets	200 tablets	60736
PB-T-XAF-1000T	Xylazyme AF Tablets	1,000 Tablets	135616
PB-T-XAX-1000T	Xylazyme AX Tablets	1,000 Tablets	205504
PB-T-XAX-200T	Xylazyme AX Tablets	200 tablets	52416
PB-T-XYZ-1000T	Xylazyme Tablets	1,000 Tablets	234832
PB-T-XYZ-200T	Xylazyme Tablets	200 tablets	60528

High quality pipette tips, Pipettes and other Laboratory products



The STARLAB group specialises in the field of Liquid Handling Technology and laboratory products. Our product portfolio includes laboratory consumables such as pipette tips, single and multi-channel pipettes, cell culture, tubes, PCR consumables, nitrile and latex

gloves, and benchtop equipment for general laboratory use.

We also provide pipette servicing for all brands and types of pipette: single and multi-channel, manual and electronic, dispensers and pipetting aids. Our state-of-the-art laboratory provides both an on-site and mail-in calibration service.



Our products and services are in daily use at research institutions in biological and medical institutes,

universities and hospitals, as well as in companies in the life sciences. We have earned an excellent reputation within the research community as a consultative company who takes a structured approach to Liquid Handling products and



support. We work very closely with our customer network to continuously improve the products we offer, and to seek out new opportunities both from a product and support perspective.

We have become a significant market player in all the product and service areas where we focus our efforts. Our success is due to our highly-trained and motivated staff and a portfolio of high quality products and services. STARLAB are liquid handling experts, with many years' experience in automated injection moulding processes for the manufacture and sale of high quality laboratory consumables for research and



CytoOne® Dishes

- ▶ Sturdy, flat bases resist bowing and warping
- ▶ Optical clarity provides distortion-free microscopy
- ▶ Stacking rings with vented design for thermal equalisation
- ▶ Vented lids improve gas exchange
- ▶ Gamma sterilised (SAL 10⁻⁵) and certified RNase, DNase, DNA and pyrogen free
- ▶ All CytoOne® dishes have untreated lids to minimise condensation
- ▶ Easy to open sleeves in convenient, small pack sizes

A selection of the different sizes of cell culture dishes from the CytoOne® product family.



BMP™ 21-LAB Printer

- ▶ Label materials for laboratory applications such as cryogenic vials and slides
- ▶ Greek symbols commonly used in the laboratory
- ▶ Barcoding
- ▶ Automated label function cuts the label according to the size of the vial
- ▶ Automated serialisation

BMP™ 21-LAB Label Printer
 Simple to operate and quick to print, the BMP™ 21-LAB label printer is an economical, must-have labelling tool especially designed for laboratory usage.

development. With TipOne® we have developed one of the world's leading pipette tip systems. Quality, price and service are STARLAB's core principles.

STARLAB is also based in the [United Kingdom](#), [Germany](#), [France](#) and [Italy](#), for the direct sales of our extensive product range. In addition, regional partners in many countries allow the purchase of STARLAB products throughout the world.

TipOne® Filter Tips

TipOne® Filter Tips	Refill	Racked
TipOne 10 µL Graduated Filter Tip (Sterile)	S1121-2710	S1121-3810
	Natural, 960 Tips	Natural, 960 Tips
	(10 Refills × 96 Tips)	(10 Racks × 96 Tips)
	Price ₹ 7,190	Price ₹ 8,280
TipOne 20 µL UltraPoint Graduated Filter Tip (Sterile)	S1123-1710	S1123-1810
	Natural, 960 Tips	Natural, 960 Tips
	(10 Refills × 96 Tips)	(10 Racks × 96 Tips)
	Price ₹ 7,290	Price ₹ 8,380
TipOne 10/20 µL XL Graduated Filter Tip (Sterile)	S1120-3710	S1120-3810
	Natural, 960 Tips	Natural, 960 Tips
	(10 Refills × 96 Tips)	(10 Racks × 96 Tips)
	Price ₹ 7,240	Price ₹ 8,330
TipOne 200 µL Graduated Filter Tip (Sterile)	S1120-8710	S1120-8810
	Natural, 960 Tips	Natural, 960 Tips
	(10 Refills × 96 Tips)	(10 Racks × 96 Tips)
	Price ₹ 6,400	Price ₹ 8,480
TipOne 300 µL Graduated Filter Tip (Sterile)	S1120-9710	S1120-9810
	Natural, 960 Tips	Natural, 960 Tips
	(10 Refills × 96 Tips)	(10 Racks × 96 Tips)
	Price ₹ 7,480	Price ₹ 8,630
TipOne 1000 µL Graduated Filter Tip (Sterile)	S1126-7710	S1126-7810
	Refill, Natural, 960 Tips	Natural, 960 Tips
	(10 Refills × 96 Tips)	(10 Racks × 96 Tips)
	Price ₹ 7,930	Price ₹ 9,140
TipOne 1000 µL XL Graduated Filter Tip (Sterile)	S1122-1730	S1122-1830
	Refill, Natural, 960 Tips	Tips
	(10 Refills × 96 Tips)	(10 Racks × 96 Tips)
	Price ₹ 7,720	Price ₹ 8,890

StarPCR® Tubes/Strips

Description	Pack Size	Cat. No.	Price (₹)
0.2 ml thin wall PCR Tubes, domed shielded cap	1 Bag × 1000 Tubes	S1602-4300	7,450
0.2 ml thin wall 8-strip PCR tubes, Individual Shielded Caps	1 Pack x 120 Strips	S1602-2900	16,760

TubeOne® Microcentrifuge Tubes

Description	Pack Size	Cat. No.	Price (₹)
1.5 ml TubeOne® Microcentrifuge Tubes	1 Bag x 500 Tubes	S1615-5500	2,040
2.0 ml TubeOne® Microcentrifuge Tubes	1 Bag x 500 Tubes	S1620-2700	4,630

TipOne® Refill System

Description	Pack Size	Cat. No.	Price (₹)
TipOne 10 µL Graduated Tip, Natural, Refill	960 Tips (10 Refills × 96 Tips)	S1111-3700	3,940
TipOne 10/20 µL XL Graduated Tip, Natural, Refill	960 Tips (10 Refills × 96 Tips)	S1110-3700	4,300
TipOne 200 µL UltraPoint Graduated Tip, Natural, Refill	960 Tips (10 Refills × 96 Tips)	S1113-1700	3,450
TipOne 1000 µL Graduated Tip, Natural, Refill	960 Tips (10 Refills × 96 Tips)	S1111-6700	4,650
TipOne 1250 µL XL Graduated Tip, Natural, Refill	960 Tips (10 Refills × 96 Tips)	S1112-1720	4,380

TipOne® Pipette Tips (Bulk)

Description	Pack Size	Cat. No.	Price (₹)
TipOne 10 µL Graduated Tip, Natural, Bulk	1 Bag × 1000 Tips	S1111-3000	2,380
TipOne 10/20 µL XL Graduated Tip, Natural, Bulk	1 Bag × 1000 Tips	S1110-3000	2,490
TipOne 200 µL Bevelled Tip, Natural, Bulk	1 Bag × 1000 Tips	S1111-1000	1,690
TipOne 200 µL UltraPoint Graduated Tip, Natural, Bulk	1 Bag × 1000 Tips	S1113-1000	1,650
TipOne 300 µL Graduated Tip, Natural, Bulk	1 Bag × 1000 Tips	S1110-9000	2,490
TipOne 1000 µL Graduated Tip, Natural, Bulk	1 Bag × 1000 Tips	S1111-6000	1,960

TipOne® Pipette Tip Rack (Empty)

Description	Pack Size	Cat. No.	Price (₹)
TipOne® Rack 10/20 µL, empty, 1 piece	-	S2311-0196	360

TipOne® Rack 200 µL, empty, 1 piece	-	S2311-0296	360
TipOne® Rack 300 µL, empty, 1 piece	-	S2311-0396	360
TipOne® Rack 1000 µL and 1250 µL, empty, 1 piece	-	S2311-1100	380
TipOne® Rack 1250 µL XL, empty, 1 piece	-	S2311-1196	380

TipOne® RPT (Repel Polymer Technology)

TipOne® RPT Filter Tips	Refill	Racked
TipOne 10/20 µL RPT XL Graduated Filter Tip (Sterile)	S1180-3710	S1180-3810
	960 Tips (10 Refills × 96 Tips)	960 Tips (10 Racks × 96 Tips)
	Price ₹ 7,900	Price ₹ 9,120
TipOne 200 µL RPT Graduated Filter Tip (Sterile)	S1180-8710	S1180-8810
	960 Tips (10 Refills × 96 Tips)	960 Tips (10 Racks × 96 Tips)
	Price ₹ 8,070	Price ₹ 9,320
TipOne 1000 µL RPT XL Graduated Filter Tip	S1182-1730	S1182-1830
	960 Tips (10 Refills × 96 Tips)	960 Tips (10 Racks × 96 Tips)
	Price ₹ 8,720	Price ₹ 9,970

CytoOne® Tissue/Cell Culture Flasks

Description	Pack Size	Cat. No.	Price (₹)
TC Treated			
T-25 CytoOne® Flask, Clear/Green Cap	300 Flasks (30 Bags × 10 Flasks)	CC7682-4325	14,300
T-75 CytoOne® Flask, Clear/Green Cap	100 Flasks (20 Bags × 5 Flasks)	CC7682-4175	10,000
T-150 CytoOne® Flask, Clear/Green Cap	40 Flasks (8 Bags × 5 Flasks)	CC7682-4415	10,800
T-225 CytoOne® Flask, Clear/Green Cap	25 Flasks (5 Bags × 5 Flasks)	CC7682-4225	9,900
Non-Treated			
T-25 CytoOne® Flask, Clear/White cap	300 Flasks (30 Bags × 10 Flasks)	CC7672-4325	15,900
T-75 CytoOne® Flask, Clear/White cap	100 Flasks (20 Bags × 5 Flasks)	CC7672-4175	10,600
T-150 CytoOne® Flask, Clear/White cap	40 Flasks (8 Bags × 5 Flasks)	CC7672-4415	11,900
T-225 CytoOne® Flask, Clear/White cap	25 Flasks (5 Bags × 5 Flasks)	CC7672-4225	8,500

CytoOne® Cell Culture Plate

Description	Pack Size	Cat. No.	Price (₹)
TC Treated			
6-Well CytoOne® Plate	1 Box × 50 Multiwell plates	CC7682-7506	6,600
12-Well CytoOne® Plate	1 Box × 50 Multiwell plates	CC7682-7512	8,400
24-Well CytoOne® Plate	1 Box × 50 Multiwell plates	CC7682-7524	7,500
48-Well CytoOne® Plate	1 Box × 50 Multiwell plates	CC7682-7548	9,000
96-Well CytoOne® Plate	1 Box × 50 Multiwell plates	CC7682-7596	8,700
Non-Treated			
6-Well CytoOne® Plate	1 Box × 50 Multiwell plates	CC7672-7506	6,500
12-Well CytoOne® Plate	1 Box × 50 Multiwell plates	CC7672-7512	7,900
24-Well CytoOne® Plate	1 Box × 50 Multiwell plates	CC7672-7524	5,500
48-Well CytoOne® Plate	1 Box × 50 Multiwell plates	CC7672-7548	6,700
96-Well CytoOne® Plate	1 Box × 50 Multiwell plates	CC7672-7596	7,700

CytoOne® Dishes

Description	Pack Size	Cat. No.	Price (₹)
TC Treated			
35 x 10 mm CytoOne® Dish	300 Dishes (10 Packets × 30 Dishes)	CC7682-3340	6,900
60 x 15 mm CytoOne® Dish	300 Dishes (10 Packets × 30 Dishes)	CC7682-3359	6,700
100 x 20 mm CytoOne® Dish	300 Dishes (10 Packets × 30 Dishes)	CC7682-3394	13,400
150 x 20 mm CytoOne® Dish	60 Dishes (5 Packets × 12 Dishes)	CC7682-3614	8,400
Non-Treated			
35 x 10 mm CytoOne® Dish	300 Dishes (10 Packets × 30 Dishes)	CC7672-3340	5,000

60 x 15 mm CytoOne® Dish	300 Dishes (10 Packets x30 Dishes)	CC7672-3359	6,300
100 x 20 mm CytoOne® Dish	300 Dishes (10 Packets x30 Dishes)	CC7672-3394	11,500
150 x 20 mm CytoOne® Dish	60 Dishes (5 Packets x 12 Dishes)	CC7672-3614	7,700

Cell Strainers (Sterile)

Description	Pack Size	Cat. No.	Price (₹)
Cell Strainer, 40 µm (Sterile), Blue	50 Pcs. (50 Box x 1 Pcs.)	CC8111-0042	12,400
Cell Strainer, 70 µm (Sterile), White	50 Pcs. (50 Box x 1 Pcs.)	CC8111-0072	12,400
Cell Strainer, 100 µm (Sterile), Yellow	50 Pcs. (50 Box x 1 Pcs.)	CC8111-0102	12,400

Cell Scraper

Description	Pack Size	Cat. No.	Price (₹)
220 mm CytoOne® Cell Scraper with 11 mm Fixed Blade, Light Blue	1 Pack x 100 Pcs.	CC7600-0220	20,900
250 mm CytoOne® Cell Scraper with 10 mm Pivoting Blade, Light Blue	1 Pack x 100 Pcs.	CC7600-0250	19,900
320 mm CytoOne® Cell Scraper with 12 mm Pivoting Blade, Light Blue	1 Pack x 100 Pcs.	CC7600-0320	21,200

Serological Pipettes

Description	Pack Size	Cat. No.	Price (₹)
1 ml Serological Pipette (sterile), individually wrapped, Yellow	1 Pack x 500 Pcs.	E4860-0001	5,850
2 ml Serological Pipette (sterile), individually wrapped, Green	1 Pack x 500 Pcs.	E4860-0002	6,750
5 ml Serological Pipette (sterile), individually wrapped, Blue	1 Pack x 200 Pcs.	E4860-0005	4,250
10 ml Serological Pipette (sterile), individually wrapped, Orange	1 Pack x 200 Pcs.	E4860-0010	5,300
25 ml Serological Pipette (sterile), individually wrapped, Red	1 Pack x 150 Pcs.	E4860-0025	6,300
50 ml Serological Pipette (sterile), individually wrapped, Purple	1 Pack x 100 Pcs.	E4860-0050	6,900
100 ml Serological Pipette (sterile), individually wrapped, Pink	1 Pack x 50 Pcs.	E4860-1100	8,700

CytoOne® Flasks with 2-Position Plug Seal Caps

Description	Pack Size	Cat. No.	Price (₹)
TC Treated			
T-25 CytoOne® Flask Vented, Clear/Green Cap	300 Flasks (30 Bags × 10 Flasks)	CC7682-4825	23,700
T-75 CytoOne® Flask Vented, Clear/Green Cap	100 Flasks (20 Bags × 5 Flasks)	CC7682-4875	14,300
T-150 CytoOne® Flask Vented, Clear/Green Cap	40 Flasks (8 Bags × 5 Flasks)	CC7682-4815	11,800
T-225 CytoOne® Flask Vented, Clear/Green Cap	25 Flasks (5 Bags × 5 Flasks)	CC7682-4822	11,500
Non-Treated			
T-25 CytoOne® Flask Vented, Clear/White cap	300 Flasks (30 Bags × 10 Flasks)	CC7672-4825	31,600
T-75 CytoOne® Flask Vented, Clear/White cap	100 Flasks (20 Bags × 5 Flasks)	CC7672-4875	19,100
T-150 CytoOne® Flask Vented, Clear/White cap	40 Flasks (8 Bags × 5 Flasks)	CC7672-4815	12,800
T-225 CytoOne® Flask Vented, Clear/White cap	25 Flasks (5 Bags × 5 Flasks)	CC7672-4822	12,400

CytoOne® Media Bottles

Description	Pack Size	Cat. No.	Price (₹)
CytoOne® Media Bottles 250 ml (Sterile)	1 Box × 24 Pcs.	CC6027-1171	9,985
CytoOne® Media Bottles 500 ml (Sterile)	1 Box × 24 Pcs.	CC6027-1172	14,500
CytoOne® Media Bottles 1000 ml (Sterile)	1 Box × 24 Pcs.	CC6027-1173	17,600

TubeOne® Microcentrifuge Tubes

Description	Pack Size	Cat. No.	Price (₹)
CytoOne® Quick-Connect™ Vacuum Filtration Pedestal, Black	1 piece	CC6000-1116	85,600
CytoOne® Vacuum Filtration Cradle Ring, Silver	1 piece	CC6000-1122	37,600

CytoOne® Vacuum Filtration (Centrifuge Tube)

Description	Pack Size	Cat. No.	Price (₹)
CytoOne® Centrifuge Tube Filtration System, Full Assembly, 0.2 µm, 50 ml	1 Box x 24 Pcs.	CC6032-1402	17,500
CytoOne® Centrifuge Tube Filtration System, Full Assembly, 0.2 µm, 15 ml	1 Box x 24 Pcs.	CC6032-1411	17,700
CytoOne® Centrifuge Tube Filtration System, Full Assembly, 0.45 µm, 50 ml	1 Box x 24 Pcs.	CC6034-1403	20,950

CytoOne® Centrifuge Tube Filtration System, Full Assembly, 0.45 µm, 15 ml	1 Box x 24 Pcs.	CC6034-1412	20,950
---	-----------------	-------------	--------

CytoOne® Bottle Top Filtration

Description	Pack Size	Cat. No.	Price (₹)
CytoOne® Bottle Top Filtration Unit, Full Assembly, 0.2 µm, 250 ml	1 Box x 12 Pcs.	CC6032-7233	11,200
CytoOne® Bottle Top Filtration Unit, Full Assembly, 0.2 µm, 500 ml	1 Box x 12 Pcs.	CC6032-8233	13,800
CytoOne® Bottle Top Filtration Unit, Full Assembly, 0.2 µm, 1000 ml	1 Box x 12 Pcs.	CC6032-9233	18,100
CytoOne® Bottle Top Filtration Unit, Full Assembly, 0.45 µm, 250 ml	1 Box x 12 Pcs.	CC6034-1141	11,900
CytoOne® Bottle Top Filtration Unit, Full Assembly, 0.45 µm, 500 ml	1 Box x 12 Pcs.	CC6034-1142	14,500
CytoOne® Bottle Top Filtration Unit, Full Assembly, 0.45 µm, 1000 ml	1 Box x 12 Pcs.	CC6034-1143	20,700

CytoOne® Syringe Filter

Description	Pack Size	Cat. No.	Price (₹)
0.22 µm Syringe Filter, PVDF (Sterile), Blue	∅ 33 mm, 1 Bag x 100 Pcs.	E4780-1221	13,000
0.22 µm Syringe Filter, Cellulose Acetate (Sterile), Blue	∅ 33 mm, 1 Bag x 100 Pcs.	E4780-1223	13,000
0.22 µm Syringe Filter, PES (Sterile), Blue	∅ 33 mm, 1 Bag x 100 Pcs.	E4780-1226	13,000
0.45 µm Syringe Filter, PVDF (Sterile), Yellow	∅ 33 mm, 1 Bag x 100 Pcs.	E4780-1451	13,000
0.45 µm Syringe Filter, Cellulose Acetate (Sterile), Yellow	∅ 33 mm, 1 Bag x 100 Pcs.	E4780-1453	13,000
0.45 µm Syringe Filter, PES (Sterile), Yellow	∅ 33 mm, 1 Bag x 100 Pcs.	E4780-1456	13,000



Liquid Handling for PerkinElmer, Thermo, Tecan, Beckman systems

Cat No.	Description	Packing	Price Rs.
A931-021	PerkinElmer CCS/FLIPR Type A 384 25 µL Clear Sterile Filtered	3840	19,439
A929-021	PerkinElmer Plate Trak 235 µL Clear Sterile Filtered	960	9,259
A921-021	Caliper Zymark 80 µL Clear Sterile Filtered	960	6,813
A921-262	Zymark 100 µL Clear Non-Sterile	960	5,634
A925-021	PerkinElmer Plate Trak 20 µL Clear Sterile Filtered	960	9,124
A927-021	PerkinElmer Plate Trak 50 µL Clear Sterile Filtered	960	8,958
A965-262	50µl clear tip,nonsterile	960	14,705
A967-021	1000µl clear tip, sterile, filtered	960	16,499
A965-021	50µl clear tip, sterile, filtered	960	16,504
A965-261	50µl clear tip, sterile	960	15,650
A967-262	1000µl clear tip,nonsterile	960	14,745
A937-261	FLIPR Liberty Type B 384 30 µL Clear Sterile	3840	15,665
A929-261	Perkin-Elmer Plate Trak 235 µL Clear Sterile	960	8,327
A916-262	Beckman FX Extended Length 50 µL Clear Low Retention	960	7,196
A937-262	FLIPR Liberty Type B 384 30 µL Clear Non Sterile	3840	15,493
A966-021	300µl clear tip, sterile, filtered	960	16,570
A986-021	Biotek Precision SBS Format 150 µL Clear Sterile Filtered	960	8,809
A967-261	1000µl clear tip, sterile	960	15,690
A916-021	Beckman FX Extended Length 40 µL Clear Sterile Filtered	960	7,840
A920-021	Caliper Zymark 50 µL Clear Sterile Filtered	960	7,953
A931-261	CCS/FLIPR Type A 384 30 µL Clear Sterile	3840	15,744
A985-021	Biotek Precision SBS Format 100 µL Clear Sterile Filtered	960	8,717
A931-262	CCS/FLIPR Type A 384 30 µL Clear Non Sterile	3840	15,584
A927-261-05	Perkin-Elmer Plate Trak 50 µL Clear Sterile	960	9,452
A925-261	Perkin-Elmer Plate Trak 20 µL Clear Sterile	960	8,741
A966-262	300µl clear tip,nonsterile	960	14,816
A984-021	Biotek Precision SBS Format 50 µL Clear Sterile Filtered	960	9,129
A927-261	Perkin-Elmer Plate Trak 50 µL Clear Sterile	960	8,563
A918-262-05	Beckman Biomek FX SPAN-8 20 µL Clear Low Retention	960	8,267
A919-261G	Beckman Biomek FX 250 µL Clear Sterile Wide Bore	960	7,811
A921-261	Zymark 100 µL Clear Sterile	960	7,282
A929-262	Perkin-Elmer Plate Trak 235 µL Clear	960	8,529
A925-262	Perkin-Elmer Plate Trak 20 µL Clear	960	8,446
A966-261	300µl clear tip, sterile	960	15,761
A927-262	Perkin-Elmer Plate Trak 5 µL Clear	960	8,254
A920-262	Zymark 50 µL Clear Non Sterile	960	6,636
A912-261	Beckman Biomek FX 10 µL Clear Sterile	960	7,960
A919-261-05	Beckman Biomek FX 250 µL Clear Sterile Low Retention	960	9,210
A918-261-05	Beckman Biomek FX SPAN-8 20 µL Clear Sterile Low Retention	960	9,211
A923-021	Caliper Zymark 100 µL Clear Sterile Filtered	960	8,113
A916-261	Beckman FX Extended Length 50 µL Clear Sterile	960	7,490
A986-261	Biotek Precision SBS Format 200 µL Clear Sterile	960	7,492
A986-262	Biotek Precision SBS Format 200 µL Clear	960	7,456
A923-262	Zymark 200 µL Clear Non Sterile	960	6,168
A907-261	Tecan Te-MO 100 µL Clear Sterile	960	7,995
A918-262	Beckman Multimek 20 µL Clear Non Sterile	960	7,225
A985-261	Biotek Precision SBS Format 100 µL Clear Sterile	960	7,400
A915-261	Beckman Biomek 20 µL Clear Sterile	960	8,003
A984-261	Biotek Precision SBS Format 50 µL Clear Sterile	960	7,826
A919-261	Beckman Biomek 250 µL Clear Sterile	960	8,013
A985-262	Biotek Precision SBS Format 100 µL Clear	960	7,205
A917-261	Beckman Biomek 250 µL Clear Sterile	960	8,016
A906-261	Tecan Te-MO 50 µL Clear Sterile	960	8,020
A935-261	Beckman 384 30 µL Clear Sterile	3840	18,532

Cat No.	Description	Packing	Price Rs.
A984-262	Biotek Precision SBS Format 50 µL Clear	960	7,604
A920-261	Zymark 50 µL Clear Sterile	960	9,005
A907-021	Tecan Te-MO 100 µL Clear Sterile Filtered	960	12,638
A919-262G	Beckman Biomek FX 250 µL Clear Wide Bore	960	9,681
A908-261	Tecan Te-MO 200 µL Clear Sterile	960	8,046
A918-251	Beckman Biomek FX SPAN-8 20 µL Conductive Sterile	960	14,136
A912-262	Beckman Biomek FX 10 µL Clear Non Sterile	960	9,691
A906-021	Tecan Te-MO 50 µL Clear Sterile Filtered	960	12,653
A918-252	Beckman Biomek FX SPAN-8 20 µL Conductive Non Sterile	960	13,620
A923-261	Zymark 200 µL Clear Sterile	960	8,413
A908-021	Tecan Te-MO 150 µL Clear Sterile Filtered	960	12,678
A912-021	Beckman Biomek FX 10 µL Clear Sterile Filtered	960	13,830
A919-021-05	Beckman Biomek FX130 µL Clear Sterile Filtered Low Retention	960	16,255
A915-021	Beckman Biomek 20 µL Clear Sterile Filtered	960	13,857
A917-021	Beckman Biomek 130 µL Clear Sterile Filtered	960	13,883
A919-251	Beckman Biomek FX SPAN-8 250 µL Conductive Sterile	960	14,241
A918-011	Beckman Biomek FX SPAN-8 20 µL Conductive Sterile Filtered	960	21,197
A919-252	Beckman FX SPAN-8 250 µL Conductive Non Sterile	960	13,726
A919-011	Beckman Biomek FX SPAN-8 130 µL Conductive Sterile Filtered	960	21,303
A906-262	Tecan Te-MO 50 µL Clear Non Sterile	960	7,260
A1064-15-7	384-Channel Reservoir, Sterile, Individually Wrapped	20	28,720
A919-262	Beckman Biomek FX 250 µL Clear Low Retention	960	6,686
A908-262	Tecan Te-MO 200 µL Clear Non Sterile	960	7,481
A1064-05-7	384-Channel Reservoir, Non Sterile	20	27,541
A917-262	Beckman Biomek 250 µL Clear Non Sterile	960	6,687
A951-253	Qiagen 300 µL Conductive Econo Pack	4800	26,705
A1064-15-8	96-Channel Reservoir, Sterile, Individually Wrapped	20	33,632
A1064-05-6	96-Channel Deep Well Reservoir, Non Sterile	20	36,471
A935-262	Beckman 384 30 µL Clear Non Sterile	3840	16,433
A1064-05-8	96-Channel Reservoir, Non Sterile	20	30,509
A907-262	Tecan Te-MO 100 µL Clear	960	7,510
A1064-15-6	96-Channel Deep Well Reservoir, Sterile, Individually Wrapped	20	41,085
A953-253	Qiagen 1100 µL Conductive Econo Pack	4800	32,159
A903-251	Tecan 200 µL Conductive Sterile	960	13,497
A903-033	Tecan 175 µL Conductive Filtered Econopack	4800	30,510
A903-253	Tecan 200 µL Conductive Non Sterile Econo Pack	4800	49,236
A953-011	Qiagen 1100 µL Conductive Sterile Filtered	960	17,642
A953-021	Qiagen 1100 µL Clear Sterile Filtered	960	15,081
A951-011	Qiagen 250 µL Conductive Sterile Filtered	960	15,353
A951-021	Qiagen 250 µL Clear Sterile Filtered	960	13,528
A902-021	Tecan 50 µL Clear Sterile Filtered	960	14,245
A903-011G	Tecan 175 µL Conductive Sterile Filtered Wide Bore	960	16,630
A904-251G	Tecan 1000 µL Conductive Sterile Wide Bore	960	18,161
A901-021	Tecan 10 µL Clear Sterile Filtered	960	14,280
A918-021	Beckman Biomek FX SPAN-8 20 µL Clear Sterile Filtered Low Retention	960	9,160
A953-251	Qiagen 1100 µL Conductive Sterile	960	17,468
A902-262XP	Tecan 50 µL Clear PATCH XPRESS	960	10,407
A919-021	Beckman Biomek FX 130 µL Clear Sterile Filtered Wide Bore	960	12,811
A903-021	Tecan 175 µL Clear Sterile Filtered	960	13,738
A935-021	Beckman 384 25 µL Clear Sterile Filtered	3840	104,667
A953-261	Qiagen 1100 µL Clear Sterile	960	14,894
A904-011	Tecan 1000 µL Conductive Sterile Filtered	960	17,052
A902-261XP	Tecan 50 µL Clear Sterile PATCH XPRESS	960	13,722
A904-011G	Tecan 1000 µL Conductive Sterile Filtered Wide Bore	960	22,265
A953-252	Qiagen 1100 µL Conductive Non Sterile	960	16,579
A951-251	Qiagen 300 µL Conductive Sterile	960	15,244
A951-261	Qiagen 300 µL Clear Sterile	960	13,343
A903-251G	Tecan 200 µL Conductive Sterile Wide Bore	960	17,915

Cat No.	Description	Packing	Price Rs.
A953-262	Qiagen 1100 µL Clear Non Sterile	960	14,019
A902-251	Tecan 50 µL Conductive Sterile	960	14,383
A904-261	Tecan 1000 µL Clear Sterile	960	14,693
A903-252G	Tecan 200 µL Conductive Wide Bore Non Sterile	960	16,261
A901-251	Tecan 20 µL Conductive Sterile	960	14,402
A902-011	Tecan 50 µL Conductive Sterile Filtered	960	17,875
A902-261	Tecan 50 µL Clear Sterile	960	15,212
A903-252	Tecan 200 µL Conductive Non Sterile	960	12,743
A903-011	Tecan 175 µL Conductive Sterile Filtered	960	17,178
A904-013	Tecan 1000 µL Conductive Sterile Filtered Econo Pack	4800	40,940
A904-021	Tecan 1000 µL Clear Sterile Filtered	960	18,470
A901-011	Tecan 10 µL Conductive Sterile Filtered	960	17,893
A903-261	Tecan 200 µL Clear Sterile	960	14,728
A904-251	Tecan 1000 µL Conductive Sterile	960	18,482
A951-262	Qiagen 300 µL Clear Non Sterile	960	12,480
A904-262	Tecan 1000 µL Clear Non Sterile	960	13,454
A901-261	Tecan 20 µL Clear Sterile	960	15,247
A904-252	Tecan 1000 µL Conductive Non Sterile	960	17,049
A902-262	Tecan 50 µL Clear Non Sterile	960	14,104
A901-252	Tecan 20 µL Conductive Non Sterile	960	13,357
A901-253	Tecan 20 µL Conductive Econo Pack	4800	51,514
A902-252	Tecan 50 µL Conductive Non Sterile	960	13,362
A903-262	Tecan 200 µL Clear Non Sterile	960	13,489
A5538	DART Tips 96 Tips, 300 ul, ST, Filtered, Extended length	1920	55,797
A5588	DART Tips 96 Tips, 30 ul, St, Filtered	1920	50,399
A915-262	Beckman Biomek 20 µL Clear Non Sterile	960	7,077
A5518-11	DART Tips 96 Tips, 300 ul, St, Filtered	1920	54,771
A904-253	Tecan 1000 µL Conductive Econo Pack	4800	51,630
A5418	DART Tips 384 Tips, 30 ul, ST, Filtered, Extended length	7680	92,081
A901-262	Tecan 20 µL Clear Non Sterile	960	14,293
A5697-100	Pocket Tip DARTs, 96 tips, 100 nL, sterile	1920	78,838
A5696-50	Pocket Tip DARTs, 96 tips, 50 nL, Non sterile	1920	78,401
A5697-50	Pocket Tip DARTs , 96 tips, 50 nL, sterile	1920	78,401
A5696-100	Pocket Tip DARTs, 96 tips 100 nL, Non sterile	1920	78,440
A5328	DART Tips 384 Tips, 100 ul, St, Filtered	7680	93,152
A5508	DART Tips 96 Tips, 30 ul, ST, Filtered, Extended length	1920	50,429
A5318	DART Tips 384 Tips, 30 ul, St, Filtered	7680	92,762
A5548	DART Tips 96 Tips, 300 ul, ST, Filtered, Extended length, wide bore	1920	65,269
A5587	DART Tips 96 Tips, 30 ul, St	1920	47,521
A5517-11	DART Tips 96 Tips, 300 ul, ST	1920	51,352
A5537	DART Tips 96 Tips, Extended Length, 300ul, ST	1920	58,239
A5527	DART Tips 96 Tips, 100 ul, ST	1920	49,366
A5547	DART Tips 96 Tips, Extended Length, Wide Bore, 300ul, ST	1920	61,850
A5516-11	DART Tips 96 Tips, 300 ul, NS	1920	50,166
A5586	DART Tips 96 Tips, 30 ul, NS	1920	47,909
A5526	DART Tips 96 Tips, 100 ul, NS	1920	48,193
A5536	DART Tips 96 Tips, Extended Length, 300 ul, NS	1920	57,095
A5546	DART Tips 96 Tips, Extended Length, Wide Bore, 300 ul, NS	1920	60,664
A5507	DART Tips, 96 Tips, Extended Length, 30 ul, Sterile	1920	45,889
A5506-11	DART Tips, 96 Tips, Extended Length, 30 ul, Non sterile	1920	45,889
A5756-50	Pocket Tip DARTs, 384 tips, 50 nL, Non sterile	7680	117,904
A5757-50	Pocket Tip DARTs 384 tips, 50 nL, sterile	7680	117,904
A5756-100	Pocket Tip DARTs , 384 tips, 100 nL, Non sterile	7680	118,073
A5757-100	Pocket Tip DARTs 100 nL, 384 tips, sterile	7680	118,073
A5417	DART Tips ,384 Tips, 30 ul , Extended Length, sterile	7680	80,397
A5327	DART Tips ,384 Tips, 100 ul ,sterile	7680	81,671
A5416	DART Tips ,384 Tips, 30 ul , Extended Length, Non sterile	7680	83,175
A5317	DART Tips ,384 Tips, 30 ul ,sterile	7680	81,281

Cat No.	Description	Packing	Price Rs.
A5326	DART Tips ,384 Tips, 100 ul , Non sterile	7680	81,180
A5316	DART Tips ,384 Tips, 30 ul , Non sterile	7680	80,095
A5302	DART Tips 384 Tips, 12.5 ul, sterile	3840	44,514
A5322	DART Tips ,384 Tips, 100 ul ,sterile	3840	54,642
A5301	DART Tips 384 Tips, 12.5 ul, Non sterile	3840	42,632
A5321	DART Tips ,384 Tips, 100 ul , Non sterile	3840	53,746
A5696-250	Pocket Tip DARTs , 96 tips, 250 nL, Non sterile	1920	213,107
A5697-250	Pocket Tip DARTs , 96 tips, 250 nL, sterile	1920	362,232
A5756-250	Pocket Tip DARTs 250 nL, 384 tips, Non sterile	7680	878,293
A5757-250	Pocket Tip DARTs 250 nL, 384 tips , sterile	7680	904,198
A904-252G	Tecan 1000 µL Conductive Wide Bore	960	16,278
A918-261	Beckman Multimek 20 µL Clear Sterile	960	7,832
A951-252	Qiagen 300 µL Conductive Non Sterile	960	14,041
A902-253	Tecan 50 µL Conductive Econo Pack	4800	48,262
AAB3738	Heat Seals for ALPS™ Microplate Heat Sealing Instruments	Each	77,880
AAB0674	Sealing Mats Round Cap (Autoclavable)	50	14,947
AAB0400	ALPS30 Manual Heat Sealer	Each	443,871
AAB1127	1.2ml Square Well LP Storage Plate	50	35,269
AAB1178	384 Well 250ul Storage Plate	50	43,696
AAB1179	Individual Storage Plate Caps	960	11,613
AAB0751	Polystyrene Plate Cover	50	14,946
AAB1056	384 Well Microarray Plate/VWells	50	35,806
AAB1058	96 Well Storage Plate/Vbottom	100	51,075
AAB1450	Adhesive Crystallography Seal	50	21,290
AAB0981	Storage Plate Cap Strips	120	14,839
AAB0862	384 Well 300ul Storage Plate	50	80,108
AAB0755	Polypropylene Plate Cover	50	13,763
AAB0788	2.2ml Storage Plate	50	42,151
AAB0661	2.2ml individual Storage Plate	50	27,895
AAB0718	Gas Permeable Adhesive Seal	50	14,632
AAB-0988	48 Well 6.0ml Storage Plate	50	81,613
AAB0787	1.2ml Storage Plate	50	35,806
AAB0675	Sealing Mats Square Cap (Autoclave)	50	21,474
AAB0933	2.2ml Storage Plate	50	42,151
AAB0796	96 Well Standard Microplate	100	31,053
AAB-3738	Abgene Easy Pierce Heat Sealing Foil 78	Each	76,240
A442404	F96 MAXISORP NUNC-IMMUNO PLATE	60	9,368
A476503	POLYSORP STARTUBE 75X12	100	34,516
A439454	F96 CERT.MAXISORP NUNC-IMMUNO PLATE	60	14,421
A469949	F8 MAXISORP LOOSE NUNC-IMMUNO MODULE	640	25,789
A375922	NUNC CRYOCOLORCODE PURPLE NEW DESIGN	2000	5,591
A374017	CRYOBANK CAP NATUR IRRADIATED RACKED	960	25,376
A347651	STOR-IT 1.0ML EXT THREAD W/PRINT SH	2000	61,290
A240541	CONTACT DISH 60X15 WITHOUT VENTS SI	396	31,828
A375868	NUNC CRYOCOLORCODE BROWN NEW DESIGN	2000	5,914
A374019	CRYOBANK CAP RED IRRADIATED RACKED	960	25,054
A354755	CRYOCOLORCODE WHITE NEW DESIGN	2000	5,806
A340061	Cryoboxes	30	15,591
A374018	CRYOBANK CAP GREEN IRRADIATED RACKED	960	25,484
A460348	NUNC-IMMUNO FRAME	60	6,211
A375884	NUNC CRYOCOLORCODE PINK NEW DESIGN	2000	6,129
A374021	CRYOBANK CAP BLUE IRRADIATED RACKED	960	25,484
A377267	CRYOTUBE 1,8ML SI INT,STARFOOT,ROUND	1800	46,842
A347643	CRYOTUBE 4.5ML EXT THREAD W/O PRN SI	1200	56,989
A355581	110X17 TEST TUBE PS SH	1800	28,387
A347597	CRYOTUBE 1.0ML.EXT THREAD W/O PRN SI	2000	69,570
A369644	ELECTRIC SCREWDRIVER EU PLUG	Each	270,968
A375418	CRYOTUBE 1,8ML SI EXT,STARFOOT,ROUND	1800	49,158

Cat No.	Description	Packing	Price Rs.
A549263	SPUTUM DISPATCH CONTAINER SH	150	22,043
A267334	U96 PP-0.5 ML NATURAL STERILE	120	21,684
A341866	STOPPER 11@ PE SH	3600	22,043
A464718	384 Well PIt PS MaxiSorp NS w/o Lid Clr 120 ul Well	30	20,737
A278752	U96 PP 2ML DEEPWELL NATURAL	60	34,316
A475094	F96 POLYSORP NUNC-IMMUNO PLATE	60	10,842
A343036	STOPPER 15@ PE SH	2400	19,355
A368632	CRYOTUBE 1,8ML SI INT,FOOT,ROUND	1800	51,474
A236707	SEALING TAPE NON STERILE, ROLL	1000	29,895
A249964	PETRI DISH 140X20 WITH VENTS SI	80	11,398
A469914	F16 MAXISORP LOOSE NUNC-IMMUNO MODULE	320	16,000
A436110	96F MAXISORP WHITE MICROWELL	80	25,789
A236366	SEALING TAPE SI	800	35,368
A468608	MINISORP 100X15 NUNC-IMMUNO TUBE	1200	19,462
A333510	TRANSPORTCONTAINER II PP/PE	400	21,720
A264576	384-Well Balck Polypropylene U bottom Plates	120	42,581
A362820	TRANSPORTCONTAINER W/SCREWCAP&INSERT	400	24,301
A248259	Nunc Nucleolink strips	1440	64,731
A347910	STOR-IT 1.0ML EXT THREAD W/O PRN SH	2000	54,409
A276000	96 WELL CAP NATURAL RADIATION STERILIZED	50	11,828
A456537	96F MAXISORP STRAIGHT W/O LID	180	43,789
A534592	AMPOULEBOX 10X1-2ML HIPS SH	200	33,226
A478042	COVALINK NH, F8 MODULE	30	30,211
A248909	Nun TopYield Strips	1440	72,688
A436017	NUNC IMMOBILIZER STREPTAVIDIN 384	15	75,368
A278616	96 WELL CAP, SI PS DEEPWELL 1.0	25	16,882
A374080	0,5 ML CRYOBANK SI VIAL LOOSE NO CODE	960	54,526
A468667	F8 MAXISORP NUNC-IMMUNO MODULE	60	25,789
A466982	MINISORP 70X11 NUNC-IMMUNO TUBE	3600	53,226
A136528	MINI TRAYS 6X12 NUNCLON DELTA SI	150	40,430
A437111	96F MAXISORP BLACK MICROWELL SH	80	24,211
A369643	SCREWDRIVER MANUAL	Each	3,978
A445101	C8 MAXISORP NUNC-IMMUNO MODULE	60	26,022
A345608	110X17 TEST TUBE W/STOPPER PS/PE SI	500	19,570
A469957	F8 POLYSORP UNFRA NUNC-IMMUNO MODULE	640	20,632
A469264	U16 MAXISORP LOOSE NUNC-IMMUNO MODULE	320	17,527
A278617	96 WELL CAP PS DEEPWELL 1.0, non sterile	30	20,860
A337516	CRYOTUBE 4,5ML SI EXT,STARFOOT,ROUND	1200	46,316
A436111	96F POLYSORP WHITE MICROWELL SH	80	30,753
A278743	U96 PP 2ML STERILE DEEPWELL NATURAL	60	45,684
A374110	Screw top tubes, sterile1 mlGreen	960	87,312
A442587	CONICAL WELL NUNC PLATE	60	8,947
A374130	Screw top tubes, sterile1 mlBlue	960	87,312
A374120	Screw top tubes, sterile1 mlRed	960	87,419
A367997	CRYOTUBE 3,6ML SH INT,ROUND,W/O CAP	1500	50,108
A374078	1,0 BANK-IT 2D CODED	960	83,441
A537176	PACKING FOR 1X20ML AMPOULE	600	57,312
A374027	Screw top tubes, sterile0.5 mlGreen	960	86,344
A374026	Screw top tubes, sterile0.5 mlRed	960	86,344
A374074	0,5 ML. BANK-IT 2D CODED	960	82,581
A342919	100X15 TEST TUBE PS SH	1200	18,280
A363436	SCREWCAP F. INT. THREAD SH CRYO	2500	43,226
A374025	Screw top tubes, sterile0.5 mlBlue	960	86,344
A343141	100X15 TEST TUBE W/STOPPER PS/PE SI	500	17,742
A256510	96F UNTREATED STRAIGHT W/O LID	180	24,731
A374086	0,5 ML. CRYOBANK VIAL 2D CODED	960	86,882
A437796	C96 WHITE MAXISORP FLUORONUNC CERT	60	20,753
A375353	CRYOTUBE 1,0ML SI EXT,STARFT,CONICAL	2000	85,579

Cat No.	Description	Packing	Price Rs.
A446140	C96 POLYSORP NUNC-IMMUNO PLATE	60	14,086
A373530	STOR-IT 1.8ML.*FOOT INK JETTED, SH	1800	134,301
A366656	CRYOTUBE 1,0ML SI INT,FOOT,CONICAL	2000	59,895
A163118	MINI TRAYS 6X10 NUNCLON D SI	150	47,789
A363282	UNIVERSALCONT 25ML W/SCREW&LABEL PSPE	300	21,474
A337846	110X16*V*CENT.TUBE MEA TESTED SI	480	23,656
A340053	Nunc Cardboard cryo boxes, 145 x 145 x 53mm	42	25,368
A354968	CRYOCOLORCODE RED NEW DESIGN	2000	5,684
A276003	96 WELL CAP YELLOW non sterile	50	11,828
A355077	CRYOCOLORCODE YELLOW NEW DESIGN	2000	5,684
A95040452	Nunc™ 1.0 and 2.0mL DeepWell™ Plates with Shared-Wall Technology	50	27,312
A360585	UNIVERSALCONT.25ML CAP,SPOON.LABEL SI	300	33,978
A473768	C8 MAXI BREAKAPART NUNC-IMMUNO MODULE	60	62,581
A364882	TRANSPORTCONTAINER GREY W/SCREW CAP 'UNIV'	300	36,947
A343923	75X12 TEST TUBE PS SH	3000	22,688
A339993	NUNC CRYOPEN	100	57,742
A538318	SPECIMEN TUBE SI 110X16*W*SCREW CAP	300	35,054
A347708	110X16*V*CENT.TUBE SCREWCAP&LABEL SI	480	33,656
A364238	UNIVERSALCONT 25ML W/SCREWCAP SI	300	13,579
A276005	96 WELL CAP BLUE non sterile	50	12,043
A364246	UNIVERSALCONT 25ML W/SCREWC & LABEL SI	300	24,731
A276002	96 WELL CAP NATURAL NON STERILE	50	9,895
A431615	FRAME BREAK APART NUNC-IMMUNO	60	7,527
A336078	SCREW CAP F. INT. SI. THREAD CRYOTUBE	2500	40,000
A436014	NUNC IMMOBILIZER STREPTAVIDIN F96 CLEAR	15	36,452
A472230	STICK MAXISORP NUNC-IMMUNO	1800	121,505
A340711	CRYOTUBE 1,8ML SI EXT,NECK,ROUND	2000	120,645
A374081	1,0 ML. CRYOBANK SI VIAL LOOSE NO CODE	960	58,632
A355018	CRYOCOLORCODE GREEN NEW DESIGN	2000	5,579
A354879	CRYOCOLORCODE BLUE	2000	5,684
A366524	CRYOTUBE 3,6ML SI INT. THREAD ROUND	1600	70,430
A347759	110X16*V*CENT.TUBE SCREWCAP PC/PP SI	480	36,774
A347856	110X16*V*CENT.TUBE SCREWCAP PS/PE SI	480	18,172
A551314	URINE SAMPLE KIT 1 TUBE & NAPKINS SI	60	22,366
A348224	110X16*U*CENT.TUBE SCREWCAP PS/PE SI	480	31,398
A363401	CRYOTUBE 1,8ML SI INT, ROUND	2000	78,710
A363452	CRYOTUBE 4,5ML SI INT,ROUND	1200	53,441
A473539	C8 POLY BREAKAPART NUNC-IMMUNO MODULE	60	70,968
A460518	384 Well Plt PS MaxiSorp NS w/o Lid Blk 120 ul Well	30	28,710
A459048	C8 MAXI B/A GREEN NUNC-IMMUNO MODULE	60	85,806
A379146	CRYOTUBE 4,5ML SI INT,STARFOOT,ROUND	1200	57,053
A9502887	White 96-Well Immuno Plates	50	22,105
A449824	U96 MAXISORP NUNC-IMMUNO PLATE	60	10,000
A377224	CRYOTUBE 1,0ML SI INT,STARFT,CONICAL	2000	95,368
A467320	MW 96F MEDISORP STRAIGHT	60	15,368
A437112	96F POLYSORP BLACK MICROWELL SH	80	30,215
A369639	Nunc Cardboard cryo boxes, 132 x 132 x 51mm	48	18,105
A473709	C12 MAXISORP NUNC-IMMUNO MODULE	60	38,817
A437702	C8 WHITE POLYSORP FLUORONUNC FIA+IFMA	60	46,989
A473717	C12 POLYSORP NUNC-IMMUNO MODULE	60	37,742
A452256	MINITRAYNUNC 60X10 PS SH	480	204,624
A470319	MAXISORP STARTUBE 75X12 NUNC-IMMUNO	3000	29,785
A379189	CRYOTUBE 3,6ML SI INT,STARFOOT,ROUND	1600	80,430
A444865	C8 POLYSORP NUNC-IMMUNO MODULE	60	43,011
A267385	U96 PP-0.5 ML BLUE	120	20,645
A348801	STOPPER 12@ PE SH	3000	15,054
A536080	STANDARD CON.PS SH 12.5 ML GLASSCLEAR	1000	21,505
A437915	C12 TRANSP MAXIS FLUORONUNC CERT	60	41,935

Cat No.	Description	Packing	Price Rs.
A362707	100X16 CENT.TUBE W/FL.BOTTOM PS SI	480	22,151
A475523	F16 BLACK POLYSORP FLUORONUNC	60	30,108
A430341	C96 MAXISORP NUNC-IMMUNO PLATE	60	11,263
A251586	INOCULATING LOOP BLUE 10 MICRO L SI	4000	24,516
A470378	MINI TRAY NUNC 72X10 PS SH	480	239,247
A267245	U96 PP-0.5 ML NATURAL	120	19,247
A536617	SNAP CAP NATUREL CONT. 12.5-20-30ML	4000	47,742
A347880	110X16*V*CENT.TUBE SCREWCAP&LABEL SI	480	27,204
A351934	CRYOTUBE 1,8ML SH INT,ROUND,W/O CAP	2500	81,290
A475434	U96 POLYSORP NUNC-IMMUNO PLATE	60	11,398
A456529	96F POLYSORP STRAIGHT W/O LID	180	36,237
A533669	MORTAR KIT COMPL. STERILIZED	50	71,075
A267350	U96 PP-0.5 ML WHITE	120	27,742
A267407	U96 PP-0.5 ML YELLOW	120	21,613
A472400	MINI TRAY S-PLATE	400	120,753
A436016	NUNC IMMOBILIZER STREPTAVIDIN F96 BLACK	15	54,731
A460984	96F MAXISORP BARCO STRAIGHT W/O LID	180	63,978
A436015	NUNC IMMOBILIZER STREPTAVIDIN F96 WHITE	15	54,731
A249719	TAPE 8 NUCLEOLINK/TOPYLD.	5760	154,731
A465404	FRAME FOR LOCKWELL NEUTRAL	60	8,710
A264675	384 WELL PP WHITE 20/120	120	116,882
A267342	U96 PP-0.5 ML BLACK	120	19,474
A467140	F8 MULTISORP NUNC IMMUNO MODULE	60	46,129
A343958	NUNC CRYOFLEX	300	88,710
A534479	AMPULE BOX 5X1-2ML HIPS SH	350	51,613
A436022	NUNC IMMOBILIZER STREPTAVIDIN C8	15	60,968
A441653	C8 STARWELL MAXI NUNC-IMMUNO MODULE	60	39,785
A341661	70X11 TEST TUBE PS SH	3600	35,914
A467679	F16 POLYSORP NUNC-IMMUNO MODULE	60	32,581
A463201	C8 LOCKWELL LUMI WHITE MAXISORP	60	45,263
A264575	384 Well Plt PP Non-Treated NS w/o Lid Wht 120 ul Well	120	123,333
A446469	LOCKWELL C8 MAXISORP	60	41,789
A536668	STANDARD CON.PS SH 50 ML CLEAR	800	47,419
A253988	INOCULATION NEEDLE YELLOW PS SI	4000	34,946
A355158	CRYOCOLORCODE ORANGE NEW DESIGN	2000	5,895
A475086	U8 POLYSORP NUNC-IMMUNO MODULE	60	42,796
A253287	INOCULATION LOOP CLEAR 1 MICRO L SI	4000	27,849
A467120	F8 MEDISORP NUNC IMMUNO MODULE	60	45,376
A475078	U8 MAXISORP NUNC-IMMUNO MODULE	60	43,871
A312800	VisionMate™ High Speed Barcode Reader	Each	1,062,526
A536684	SNAP CAP, GREY PE FOR CONT.50 ML SH	2400	103,871
A254399	INOCULATIONNEEDLE YELLOW PS SI	2400	29,247
A263991	PETRI DISH 100X15 WITH VENTS SI	320	15,053
A446490	LOCKW C8 MultiSorp MULTISORP	60	54,301
A463975	F8 MAXISORP RED NUNC-IMMUNO MODULE	60	57,419
A375906	NUNC CRYOCOLORCODE GREY NEW DESIGN	2000	5,474
A462456	F8 MAXISORP GREEN NUNC-IMMUNO MODULE	60	57,419
A462465	F8 MAXISORP WHITE NUNC-IMMUNO MODUEL	60	57,419
A475445	LOCKWELL C8 RED POLYSORP	60	63,441
A254437	INOCULATING LOOP BLUE 10 MICRO L SI	2400	30,215
A475426	LOCKWELL C8 RED MAXISORP	60	62,473
A473237	LOCKWELL C8 YELLOW MAXISORP	60	62,473
A475000	LOCKWELL C8 GREEN MAXISORP	60	62,473
A446473	C8 LOCKWELL FLUORO BLACK POLYSORP	60	46,344
A446639	LOCKWELL U8 MAXISORP	60	44,194
A446470	LOCKWELL C8 MEDISORP	60	45,484
A536323	STANDARD CON.PS SH 20ML GLASSCLEAR	2400	126,667
A446442	LOCKWELL C8 POLYSORP	60	44,624

Cat No.	Description	Packing	Price Rs.
A443990	MINISORP 75X12 NUNC-IMMUNO TUBE	3000	28,632
A444202	MAXISORP 75X12 NUNC-IMMUNO TUBE	3000	23,474
A254410	INOCULATING LOOP CLEAR 1 MICRO L SI	2400	32,366
A463200	C8 LOCKWELL LUMI WHITE POLYSORP	60	52,043
A448526	LOCKWELL MAXISORP C8 STARWELL	60	52,581
A436008	NUNC IMMOBILIZER AMINO F96 BLACK	30	58,172
A376589	NUNC CRYORACK FOR 40 TUBES	15	36,129
A446471	C8 LOCKWELL FLUORO BLACK MAXISORP	60	58,925
A436007	NUNC IMMOBILIZER AMINO WHITE	30	60,215
A436023	NUNC IMMOBILIZER AMINO C8	30	62,366
A374088	1,0 ML. CRYOBANK VIAL 2D CODED	960	74,842
A436032	NUNC IMMOBILIZER GLUTATHIONE F96 CLEAR	15	46,129
A436006	NUNC IMMOBILIZER AMINO F96 CLEAR	30	49,355
A436013	NUNC IMMOBILIZER AMINO 12X8 STRIPS	30	66,452
A336068	SCREWCAP F. EXT.SI THREAD CRYOTUBE	2500	41,935
A536455	STANDARD CON.PS SH 30 ML GLASSCLEAR	1200	103,978
A444474	MAXISORP 70X11 NUNC-IMMUNO TUBE	1800	16,774
A437958	C96 TRANSP MAXIS FLUORONUNC CERT	60	23,333
A448496	LOCKWELL POLYSORP C8 STARWELL	60	50,968
A362308	100X16 CENT.TUBE W/FLAT BOT. PS SH	480	28,280
A430414	PUSH OUT TOOL FOR BREAK APART	240	12,473
A459990	F8 MAXISORP YELLOW NUNC-IMMUNO MODULE	60	57,419
A474691	LOCKWELL C8 BLUE MAXISORP	60	62,473
A476423	LOCKWELL C8 TURQUOISE MAXISORP	60	62,473
A475442	LOCKWELL C8 WHITE MAXISORP	60	62,473
A475957	LOCKWELL C8 BLACK MAXISORP	60	62,473
A475001	LOCKWELL C8 BLUE POLYSORP	60	63,441
A475444	LOCKWELL C8 YELLOW POLYSORP	60	63,441
A475443	LOCKWELL C8 GREEN POLYSORP	60	63,441
A436009	NUNC IMMOBILIZER AMINO 384	30	92,688
A562006	ORGAN CONTAINER	140	71,398
A436018	NUNC IMMOBILIZER STREPTAVIDIN 384	15	77,634
A459049	C8 B/A BURGUNDY MAXISORP MODULE	60	80,860
A469922	F16 POLYSORP UNFRA NUNC-IMMUNO MODULE	320	12,000
A375930	NUNC CRYOCOLORCODE ASSORTED NEW DESIGN	2000	6,526
A347627	CRYOTUBE 1.8ML EXT THREAD W/O PRN SI	1800	68,316
A264122	MICROWELL LID MODULES/PLATES	50	6,105
A475515	F16 BLACK MAXISORP FLUORONUNC CERT	60	21,474
A467340	MW 96F MULTISORP STRAIGHT	60	15,789
A263339	MICROWELL LID MODULES/PLATES	100	5,376
A446612	C96 MAXISORP CERT. NUNC-IMMUNO PLATE	60	19,158
A437591	C8 WHITE MAXISORP FLUORONUNC CERT FIA+IFMA	60	47,053
A436020	NUNC IMMOBILIZER STREPTAVIDIN 12X8 STRIPS	15	53,053
A467466	F16 MAXISORP NUNC-IMMUNO MODULE	60	33,053
A469078	F8 POLYSORP NUNC-IMMUNO MODULE	60	38,947
A4641100N	F1 SC Variable Volume 100-1000 µL	Each	20,500
A4641080N	F1 SC Variable Volume 20-200 µL	Each	20,500
A4641070N	F1 SC Variable Volume 10-100 µL	Each	20,500
A4641060N	F1 SC Variable Volume 2-20 µL	Each	20,500
A4641010N	F1 SC Variable Volume 0.2-2 µL, micro	Each	20,500
A4641110N	F1 SC Variable Volume 0.5-5 mL	Each	20,500
A4641040N	F1 SC Variable Volume 1-10 µL	Each	20,500
A4641120N	F1 SC Variable Volume 1-10 mL	Each	20,500
A4641140N	F1 SC Variable Volume 5-50 µL	Each	20,500
A4641030N	F1 SC Variable Volume 1-10 µL, micro	Each	20,500
A4641020N	F1 SC Variable Volume 0.5-5 µL, micro	Each	20,500
A4641050N	F1 SC Variable Volume 2-20 µL, micro	Each	20,500
A4641130N	F1 SC Variable Volume 5-50 µL, micro	Each	20,500

Cat No.	Description	Packing	Price Rs.
A4641090N	F1 SC Variable Volume 30-300 µL	Each	20,500
A9402151	Finntip 10 mL, Bulk	100	1,434
A9402030	Finntip 5 mL, Bulk	500	3,403
A9400360	Finntip 50, Bulk	1000	3,276
A9400100	Finntip 200 Ext	400	3,427
A9400230	Finntip 250 Universal, Bulk	1000	1,495
A9404193	Finntip Stepper, 2.25 mL, sterile	50	6,923
A9400620	Finntip 20, Bulk	1000	1,927
A9401030	Finntip 1000, Bulk	1000	2,281
A9401260	Finntip 300, Bulk	1000	2,163
A9400310	Finntip 10, Bulk	1000	2,835
A4700880	F2 Kit 2 (0.2 to 1000 µL)	Each	44,000
A94060720	Finntip Flex 1000	1000	8,751
A94060310	Finntip Flex 200	960	6,726
A9420400	F-Stand, Linear Stand, white, 6 positions	Each	4,308
A94052550	Finntip Filter 5 mL, sterile	270	8,243
A94410217	ClipTip 20, Reload Stacks, 10 x 96/inserts	960	2,943
A94410517	ClipTip 300, Reload Stacks, 10 x 96/inserts	960	2,881
A94052000	Finntip Filter Micro 10 µL, sterile	960	7,861
A4421290	Extended Discharge Tubing, 0.2-10 mL	Each	9,282
A94410257	ClipTip 50, Reload Stacks, 10 x 96/inserts	960	3,064
A9400370	Finntip 50, Racked, Non sterile	3840	13,768
A94410510	ClipTip 300, Racked, 10 x 96/rack	960	3,524
A9404230	Finntip Stepper, 50 mL	10	1,117
A94420218	ClipTip 20, Filter, Reload, Sterile, 10 x 96/inserts	960	6,653
A94420258	ClipTip 50, Filter, Reload, Sterile, 10 x 96/inserts	960	6,653
A94420318	ClipTip 200, Filter, Reload, Sterile, 10 x 96/inserts	960	6,653
A94420518	ClipTip 300, Filter, Reload, Sterile, 10 x 96/inserts	960	6,653
A94053300	Finntip BioCon 1000	50	3,328
A94420718	ClipTip 1000, Filter, Reload, Sterile, 8 x 96/inserts	768	7,416
A94053200	Finntip BioCon 250	100	3,666
A9404220	Finntip Stepper, 25 mL	20	1,401
A9401070	Finntip 1000	200	935
A9400250	Finntip 250 Universal, Bulk	500	1,124
A94410153	ClipTip 384 125, sterile	3840	26,699
A4700860N	F1 GLP KIT2 (0.2-1000 ul)	Each	68,873
A2206-590	8 Channel Module only	Each	49,218
A94052410	Finntip Filter 1000 µL, sterile	960	11,554
A4421300	Extended Discharge Tubing, 5-60 mL	Each	10,423
A9402050	Finntip 5 mL	75	1,032
A94060517	Finntip Flex 300 refill	1920	10,094
A9404210	Finntip Stepper, 12.5 mL	50	2,948
A4651100N	F1 Fixed Volume 3000 µL	Each	9,306
A94410103	ClipTip 384 30, Sterile	3840	24,942
A9402070	Finntip 5 mL,racked	270	4,468
A94060120	Finntip Flex 10, Bulk	1000	1,693
A94410813	ClipTip 1250, Sterile	768	5,398
A9402150	Finntip 10 mL	40	931
A4701070	F2 Kit 4 (2 to 1000 µL)	Each	32,947
A9402073	Finntip 5 mL racked, sterile	270	7,267
A4421120	Range: 0.2-1.0 mL	Each	27,382
A94410518	ClipTip 300, Reload Stacks, Sterile, 10 x 96/inserts	960	4,368
A9401110	Finntip 1000, Racked	960	4,997
A4500020	Digital Pipette 0.5-10 ul,	Each	12,827
A4661030N	F1 8MC Variable Volume 30-300 µL	Each	52,737
A4700870	F2 Kit 1 (1 to 1000 µL)	Each	32,947
A94410513	ClipTip 300, Racked, Sterile, 10 x 96/rack	960	4,669
A4651020N	F1 Fixed Volume 10 µL	Each	9,331

Cat No.	Description	Packing	Price Rs.
A9400610	Finntip 20, Racked, Non sterile	3840	11,546
A9400260	Finntip 250 Universal, racked, Non sterile	960	3,376
A9401410	Finntip 1000 Ext	1000	4,166
A94410610	ClipTip 300 Ext, 8 x 96/rack, Low Retent	768	3,481
A9404200	Finntip Stepper, 5.0 mL	50	2,698
A94410100	ClipTip 384 30	3840	22,443
A94410618	ClipTip 300 Ext Reload, 10 x 96/insert,	960	9,226
A4540000	Finnpipette Stepper	Each	13,847
A4651030N	F1 Fixed Volume 25 µL	Each	9,344
A4651130N	F1 Fixed Volume 20 µL	Each	9,344
A94052600	Finntip Filter 10 mL, sterile	120	7,530
A9402160	Finntip 10 mL, racked	120	3,807
A9401255	Finntip 300 refill	1920	6,385
A9404180	Finntip Stepper, 1.25 mL	100	4,937
A94060970	Finntip Flex 10 mL Ext	100	6,833
A94060820	Finntip Flex 1200	1000	4,401
A94410250	ClipTip 50, Racked, 10 x 96/rack	960	3,747
A4661070N	F1 12 MC Variable Volume 30-300 µL	Each	56,947
A94410718	ClipTip 1000, Reload Stacks, Sterile, 8 x 96/inserts	768	4,939
A9400300	Finntip 10, Racked, Non sterile	960	4,281
A94410258	ClipTip 50, Reload Stacks, Sterile, 10 x 96/inserts	960	4,546
A94410218	ClipTip 20, Reload Stacks, Sterile, 10 x 96/inserts	960	4,546
A94410318	ClipTip 200, Reload Stacks, Sterile, 10 x 96/inserts	960	4,546
A94420253	ClipTip 50, Filter, Racked, Sterile, 10 x 96/rack	960	7,126
A4540-500	Finnpipette Multistepper -Handle and Module	Each	75,128
A9404183	Finntip Stepper, 1.25 mL, sterile	50	6,868
A9400266	Finntip 250 Universal refill starter kit	1344	4,133
A94052300	Finntip Filter 200 µL, sterile	960	9,709
A9401423	Finntip 1000 Ext sterile	480	6,771
A94060320	Finntip Flex 200	1000	2,714
A9401300	Finntip Multistepper Tips	400	2,493
A94060316	Finntip Flex 200 refill starter kit	2016	10,874
A94060510	Finntip Flex 300	960	6,726
A94410053	ClipTip 384 12.5, Sterile	3840	28,598
A9404170	Finntip Stepper, 0.5 mL	100	4,720
A9401250	Finntip 300, Racked, Non sterile	960	3,735
A94052320	Finntip Filter 200 µL Ext, sterile	960	12,160
A4661020N	F1 8MC Variable Volume 10-100 µL	Each	52,737
A9057	Hydrophobic Filters, 0.45 µm	25	15,211
A94410317	ClipTip 200, Reload Stacks, 10 x 96/inserts	960	2,881
A94410310	ClipTip 200, Racked, 10 x 96/rack	960	3,524
A94410210	ClipTip 20, Racked, 10 x 96/rack	960	3,524
A4580560	Hydrophobic Filters, 0.45 µm	5	2,857
A4670040BT	E1-ClipTip 50-1250 µl	Each	61,745
A9400267	Finntip 250 Universal refill	1920	5,589
A4701130	GLP Novus Kit 4 (10-10000 µl)	Each	113,616
A94410150	ClipTip 384 125	3840	24,733
A9401253	Finntip 300 racked, sterile	960	5,863
A94052060	Finntip Filter Micro 50 µL, sterile	3840	26,289
A9420510	E1 Clip Tip stand 3 positions	Each	20,339
A4421170	Dispenser Range: 10-60 mL	Each	39,296
A94060317	Finntip Flex 200 refill	1920	11,339
A4641200N	F1-ClipTip 10-100 µl	Each	24,442
A94060117	Finntip Flex 10 refill kit	1920	8,970
A94052350	Finntip Filter 300 µL, sterile	960	8,690
A9420290	Pipette Stand, gray, for 6 pipetters	Each	5,187
A9510027	Reagent Basin, 60 mL, 5/Box	5	1,055
A9405160	Finntip 1000 Wide	960	8,366

Cat No.	Description	Packing	Price Rs.
A4670030BT	E1-ClipTip 10-300 µl	Each	59,319
A94053100	Finntip BioCon 10	100	3,667
A94410313	ClipTip 200, Racked, Sterile, 10 x 96/rack	960	4,860
A4701060N	F1 GLP KIT 4 (2-1000 ul)	Each	53,376
A4641230N	F1-ClipTip 100-1000 µl*	Each	23,981
A4641210N	F1-ClipTip 20-200 µl	Each	23,981
A4672090BT	E1-ClipTip Equalizer 6-ch 50-1250 µl	Each	107,557
A94410713	ClipTip 1000, Racked, Sterile, 8 x 96/rack	768	5,233
A9404213	Finntip Stepper, 12.5 mL, sterile	25	3,323
A9402010	Finntip 5 mL, Bulk	3000	18,484
A9404233	Finntip Stepper, 50 mL, sterile	10	1,920
A4500010	Digital Pipette 0.5-10 ul,euro	Each	12,825
A4700850N	F1 GLP KIT 1 (1-1000 ul)	Each	53,376
A94060710	Finntip Flex 1000	960	10,893
A4661000N	F1 8MC Variable Volume 1-10 µL	Each	52,737
A4672030BT	E1-ClipTip Equalizer 384 8-ch 1-30µl	Each	118,347
A4671100BT	E1-ClipTip 8-ch 50-1250 µl	Each	88,678
A9404190	Finntip Stepper, 2.25 mL	100	3,991
A94056520	Finntip Flex Filter 100 µL, sterile	960	14,110
A94056510	Finntip Flex Filter 30 µL, sterile	960	14,110
A94056810	Finntip Flex Filter 1200 µL, sterile	960	16,270
A9405120	Finntip 250 Wide	960	10,212
A9405060	Finntip 1000 Wide	6500	28,037
A94060817	Finntip Flex 1200 refill	1536	11,485
A9401115	Finntip 1000 refill	960	5,744
A9405163	Finntip 1000 Wide sterile	960	11,394
A9400220	Finntip 250 Universal, Bulk	20000	34,306
A4661060N	F1 12 MC Variable Volume 10-100 µL	Each	56,947
A46300800	Finnpipette Novus MC8 100-1200 µL	Each	89,180
A9420390	Multichannel Pipetter Stand, 1 position	Each	1,492
A4700885	F2 Kit 3 (10 to 10,000 µL)	Each	32,947
A94410253	ClipTip 50, Racked, Sterile, 10 x 96/rack	960	4,860
A9401113	Finntip 1000 racked,sterile	960	8,926
A9401420	Finntip 1000 Ext	480	5,992
A4641180N	F1-ClipTip 2-20 µl	Each	24,442
A94410050	ClipTip 384 12.5	3840	24,733
A4671080BT	E1-ClipTip 12-ch 10-300 µl	Each	108,107
A4651050N	F1 Fixed Volume 100 µL	Each	9,148
A94410710	ClipTip 1000, Racked, 8 x 96/rack	768	3,918
A4421160	Dispenser Range: 5-30 mL	Each	37,696
A94056380	Finntip Flex Filter 200 µL, sterile	960	15,948
A94060810	Finntip Flex 1200	960	12,248
A46200600	Finnpipette Novus SC 100-1000 µL	Each	42,857
A4661010N	F1 8MC Variable Volume 5-50 µL	Each	52,737
A94410810	ClipTip 1250	768	5,252
A4651080N	F1 Fixed Volume 1000 µL	Each	9,136
A4651040N	F1 Fixed Volume 50 µL	Each	9,148
A4671030BT	E1-ClipTip 16-ch 1-30 µl	Each	125,437
A4671090	E1-ClipTip 12-ch 30-850 µl	Each	108,107
A9400303	Finntip 10 racked, sterile	960	7,357
A9405050	Finntip 1000 Wide	400	2,373
A4661180N	F1-ClipTip 12-ch 30-300 µl	Each	69,165
A4662040	F2 MC12 Variable Volume 1-10 µL	Each	35,895
A46200400	Finnpipette Novus SC 10-100 µL	Each	42,846
A94410619	ClipTip 300 Ext Empty Rack	8	3,643
A94410060	ClipTip 12.5 Ext, 10 x 96/rack	960	7,501
A94410073	ClipTip 384 12.5 Ext, 10 x 384/rack, Ste	3840	58,450
A94410617	ClipTip 300 Ext Reload, 10 x 96/insert,	960	7,302

Cat No.	Description	Packing	Price Rs.
A94410063	ClipTip 12.5 Ext, 10 x 96/rack, Sterile	960	9,720
A94420613	ClipTip 300 Ext Filter, 8 x 96/rack, Ste	768	9,388
A94410613	ClipTip 300 Ext, 8 x 96/rack, Sterile, L	768	8,163
A94420063	ClipTip 12.5 Ext Filter, 10 x 96/rack, S	960	11,177
A94420073	ClipTip 384 12.5 Ext Filter, 10 x 384/ra	3840	78,816
A94056580	Finntip Flex Filter 300 µL, sterile	960	15,184
A94410817	ClipTip 1250, Reload	768	4,289
A4670020BT	E1-ClipTip 2-125 µl	Each	61,745
A4670000BT	E1-ClipTip 0.5-12.5 µl	Each	61,745
A4651070N	F1 Fixed Volume 500 µL	Each	9,136
A94052200	Finntip Filter 100 µL, sterile	960	7,520
A9400263	Finntip 250 Universal racked, sterile	960	5,688
A94060516	Finntip Flex 300 refill starter kit	2016	13,322
A94060513	Finntip Flex 300 sterile	960	13,214
A9065-11	Silicone Pipette Gripper	4	5,347
A4660020	Fp F3 30-300 µl MCP8	Each	64,793
A94420103	ClipTip 384 30 Filter, Sterile	3840	34,747
A94052450	FT Filter 1500 µl	960	14,810
A94410717	ClipTip 1000, Reload Stacks, 8 x 96/inserts	768	3,157
A9401333	Finntip Multistepper, racked, sterile	960	11,471
A9420340	Carousel Stand, for 6 manual or 3 electronic pipettors, including cover	Each	10,993
A9067	Single Pipette Table Stand	Each	2,695
A94060100	Finntip Flex 10	960	6,575
A4700865N	F1 GLP KIT 3 (10-10,000 ul)	Each	53,376
A4510020	FP-Dig MCP-8 5-50 µl	Each	31,295
A4500110	Finpipette Digital 10-100µl	Each	18,534
A4500000	Finpipette Digital 0.2-2 µl	Each	21,381
A4510040	FP-Dig MCP-12 5-50 µl	Each	34,920
A4510070	FP-MCP 16-ch 5-50µl	Each	49,533
A4510050	FP-Dig MCP-12 50-300 µl	Each	38,693
A4500080	Finnpipette Digital 2-20 µl	Each	20,088
A4500120	Finnpipette Digital 100-1000ul	Each	17,682
A4500090	Finnpipette Digital 20-200µl	Each	17,090
A4500100	Finpipette Digital 5-50 µl	Each	19,052
A4510030	FP-Dig MCP-8 50-300 µl	Each	34,254
A94420043	ClipTip 12.5, Filter, Sterile	960	7,171
A94420313	ClipTip 200, Filter, Racked, Sterile, 10 x 96/rack	960	6,977
A9401330	Finntip Multistepper Tips, Racked, Non sterile	960	8,494
A9402163	Finntip 10 mL racked, sterile	120	6,489
A4661040N	F1 12 MC Variable Volume 1-10 µL	Each	56,947
A9400327	Finntip 10 refill	3840	16,180
A4671070BT	E1-ClipTip 8-ch 10-300 µl	Each	92,306
A94060813	Finntip Flex 1200 sterile	960	11,405
A94052310	Finntip Filter 100 µL Ext, sterile	960	12,217
A4672080BT	E1-ClipTip Equalizer 8-ch 10-300 µl	Each	118,347
A4500070	Digital SC Variable Volume pipette, 2-10 ml	Each	13,672
A46200700	Finnpipette Novus SC 0.5-5 mL	Each	42,796
A4661210N	F1-ClipTip 8-ch 1-10 µl	Each	63,601
A4661130N	F1-ClipTip 8-ch 10-100 µl	Each	63,602
A94420053	ClipTip 384 12.5, Filter, Sterile	3840	27,018
A4672100BT	E1-ClipTip Equalizer 8-ch 50-1250 µl	Each	118,347
A9404223	Finntip Stepper, 25 mL, sterile	10	1,847
A95128095	Reagent Reservoir 25 ml divided 100/Box	100	3,948
A46200000	Finnpipette Novus SC 1-10 µL micro	Each	42,787
A94052100	Finntip Filter 10 µL, sterile	960	11,282
A4510000	0.5-10 µl,MCP, 8 Channel	Each	32,828
A46300300	Finnpipette Novus MC12 5-50 µl	Each	79,359
A4500060	Digital SC Variable Volume pipette, 1-5 ml	Each	13,701

Cat No.	Description	Packing	Price Rs.
A4671050BT	E1-ClipTip 12-ch 2-125 µl	Each	112,530
A94420513	ClipTip 300, Filter, Racked, Sterile, 10 x 96/rack	960	6,702
A9400130	Finntip 200 Ext	960	6,532
A95128093	Reagent Reservoir 25 ml 100/Box	100	4,021
A95128085	Reagent Reservoir 100 ml 100/Box	100	5,604
A94060520	Finntip Flex 300	1000	6,155
A46300400	Finnpipette Novus MC8 30-300 µL	Each	73,487
A9404203	Finntip Stepper, 5.0 mL, sterile	25	2,800
A94420153	ClipTip 384 125 Filter, sterile	3840	35,494
A4641220N	F1-ClipTip 30-300 µl	Each	25,787
A4651270N	F1-ClipTip 1000 µl*	Each	15,240
A4651240N	F1-ClipTip 200 µl	Each	15,240
A4651230N	F1-ClipTip 100 µl	Each	15,240
A9405123	Finntip 250 Wide sterile	960	11,670
A4661090N	F1 16 MC Variable Volume 5-50 µL	Each	80,494
A94060116	Finntip Flex 10 refill starter kit	2016	12,398
A9069	Wing Stand for Serological Pipette Filler	Each	890
A46300500	Finnpipette Novus MC12 30-300 µL	Each	80,977
A4661050N	F1 12 MC Variable Volume 5-50 µL	Each	56,947
A46300100	Finnpipette Novus MC121-10 µL	Each	82,605
A4641320N	F1-ClipTip 1-10 µl	Each	26,841
A4641310N	F1 Clip Tip 0.1-2 µl	Each	26,841
A4641190N	F1-ClipTip 5-50 µl	Each	26,841
A4651260N	F1-ClipTip 500 µl*	Each	15,864
A4651280N	F1-ClipTip 10 µl	Each	15,864
A4651200N	F1-ClipTip 20 µl	Each	15,864
A4651210N	F1-ClipTip 25 µl	Each	15,864
A4651220N	F1-ClipTip 50 µl	Each	15,864
A4651250N	F1-ClipTip 250 µl	Each	15,864
A4671040BT	E1-ClipTip 8-ch 2-125 µl	Each	92,306
A94410519	Empty Rack, Medium	10	2,781
A94410819	Empty Rack, Large	8	2,781
A9070	1 mL Pipette Support	Each	1,308
A4672040BT	E1-ClipTip Equalizer 384 12-ch 1-30µl	Each	124,736
A4421140	Range: 1-5 mL	Each	26,785
A4672070BT	E1-ClipTip Equalizer 384 12-ch 2-125µl	Each	119,833
A94060717	Finntip Flex 1000 refill	1536	11,795
A94060716	Finntip Flex 1000 refill starter kit	1632	17,369
A94410818	ClipTip 1250, Reload, Sterile	768	4,762
A94060103	Finntip Flex 10 sterile	960	7,660
A9401240	Finntip 300, Bulk	20000	35,511
A4641170N	F1-ClipTip Single Channel Pipette , 1-10ul	Each	19,909
A94052150	Finntip Filter 20 µL, sterile	960	11,282
A46200100	Finnpipette Novus SC 1-10 µL	Each	43,611
A46200800	Finnpipette Novus SC 1-10 mL	Each	42,796
A94420818	ClipTip 1250, Filter Reload, Sterile	768	7,545
A4421260	Bottle Adapters A25 & A38 (one of each)	Each	4,713
A4421270	Extended Suction Tube, 0,2-10 mL	Each	3,772
A4421280	Extended Suction Tube, 5-60 mL	Each	3,772
A4662080	F2 MC16 Variable Volume 1-10 µL	Each	67,895
A4672020BT	E1-ClipTip Equalizer 384 12-ch 0.5-12.5µl	Each	124,736
A4701120	GLP Novus Kit 3 (1-1000 µl)	Each	111,358
A94056970	Finntip Flex Filter 10 mL Ext, sterile	50	5,976
A94060313	Finntip Flex 200 sterile	960	9,244
A4661080N	F1 16 MC Variable Volume 1-10 µL	Each	80,597
A9404173	Finntip Stepper, 0.5 mL, sterile	50	6,824
A94410043	ClipTip 12.5, Sterile	960	5,486
A9510037	Reservoir, 8-well, 10 mL, 10/Box	10	1,905

Cat No.	Description	Packing	Price Rs.
A4651120N	F1 Fixed Volume 10000 µL	Each	9,097
A94420213	ClipTip 20, Filter, Racked, Sterile, 10 x 96/rack	960	6,702
A94420713	ClipTip 1000, Filter, Racked, Sterile, 8 x 96/rack	768	7,457
A4421130	Range: 0.4-2.0 mL	Each	27,300
A9420300	Stepper Adaptor (10/Box)	10	3,694
A4421150	Range: 2-10 mL	Each	26,785
A9401010	Finntip 1000, Bulk	20000	28,700
A4651110N	F1 Fixed Volume 5000 µL	Each	9,109
A4671010BT	E1-ClipTip 12-ch 0.5-12.5 µl	Each	112,530
A94410213	ClipTip 20, Racked, Sterile, 10 x 96/rack	960	4,860
A4651060N	F1 Fixed Volume 250 µL	Each	9,136
A46200500	Finnpipette Novus SC 30-300 µL	Each	42,852
A4672050BT	E1-ClipTip Equalizer 8-ch 2-125 µl	Each	118,347
A4661220N	F1-ClipTip 12-ch 1-10 µl	Each	71,995
A4661160N	F1-ClipTip 12-ch 5-50 µl	Each	71,995
A9400613	Finntip 20 , Raacked, sterile	3840	11,922
A94060713	Finntip Flex 1000 sterile	960	12,962
A4701150N	F1-ClipTip 2CLP Kit2	Each	137,327
A4661120N	F1-ClipTip 8-ch 5-50 µl	Each	61,569
A4661140N	F1-ClipTip 8-ch 30-300 µl	Each	59,150
A94056710	Finntip Flex Filter 1000 µL, sterile	960	19,353
A46200300	Finnpipette Novus SC 5-50 µL	Each	42,798
A9400373	Finntip 50 Racked, sterile	3840	16,047
A94410219	Empty Rack, Small	10	4,130
A4701140N	F1-ClipTip GLP Kit 1	Each	61,971
A4662090	F2 MC16 Variable Volume 5-50 µL	Each	67,895
A46300000	Finnpipette Novus MC8 1-10 µL	Each	76,520
A46300700	Finnpipette Novus MC16 5-50 µL	Each	83,565
A9420360	Novus Single Pipetter Stand	Each	5,409
A9420500	Single charging stand (incl. power supply)	Each	11,901
A46300200	Finnpipette Novus MC85-50 µL	Each	73,437
A9510047	Reservoir, 1-well, 100 mL, 10/Box	10	1,905
A4671000BT	E1-ClipTip 8-ch 0.5-12.5 µl	Each	92,306
A4651090N	F1 Fixed Volume 2000 µL	Each	9,110
A4672060BT	E1-ClipTip Equalizer 384 8-ch 2-125µl	Each	118,347
A4672010BT	E1-ClipTip Equalizer 384 8-ch 0.5-12.5µl	Each	113,695
A94052020	Finntip Filter Micro 20 µL, sterile	3840	21,891
A9405020	Finntip 250 Wide	1000	4,195
A4651140N	F1 Fixed Volume 200 µL	Each	9,136
A94410070	ClipTip 384 12.5 Ext, 10 x 384/rack	3840	48,466
A94052430	Finntip Filter 1000 µL Ext, sterile	480	10,100
A9400326	Finntip 10 refill starter kit	2688	11,204
A4661170N	F1-ClipTip 12-ch 10-100 µl	Each	71,995
A94060816	Finntip Flex 1200 refill starter kit	1632	16,432
A4671060BT	E1-ClipTip 16-ch 2-125 µl	Each	125,437
A4700490	GLP Novus Kit 2 (100-5000 µl)	Each	78,202
A4510010	0.5-10 µl, multi channel (12 channels)	Each	37,054
A4700470	GLP Novus Kit 1 (10-100 µl)	Each	76,629
A9400133	Finntip 200 Ext sterile	960	12,209
A46200200	Finnpipette Novus SC 5-50 µL micro	Each	43,656
A94420813	ClipTip 1250, Filter, Sterile	768	7,803
A94410040	ClipTip 12.5	960	5,539
A4671020BT	E1-ClipTip 16-ch 0.5-12.5 µl	Each	125,437
A4540500	Finnpipette Multistepper -Handle and Module	Each	75,128
A9065MX	Silicone Pipette Gripper	4	5,461
A4641030	Finnpipette F1 1-10 µl micro	Each	20,968
A4641060	Finnpipette F1 2-20 ul	Each	20,968
A8094	Indiv. wrapped	50	7,767

Cat No.	Description	Packing	Price Rs.
A8086	50 Indiv. wrapped	50	7,938
A8093	10 Bags of 10	100	7,271
A8095	10 Bags of 10	100	8,085
A8085	10 Bags of 10	100	7,974
A7156	250 µL ECOTIPS	960	7,422
A8042	1250 µL Tip, sterile	960	12,335
A7281	250 µL TallTip	960	8,667
A7282	250 µL TallTip, sterile	960	9,593
A8096	50 Indiv. wrapped	50	8,120
A8045	1250 µL Filter Tip, sterile	960	15,627
A7431	30 µL 384 Tip	3840	39,710
A7151	250 µL Tip	960	7,967
A7631	30 µL TallTip	960	9,440
A7285	200 µL TallTip Filter Tip, sterile	960	15,271
A7152	250 µL Tip, sterile	960	8,893
A7321-11	300 µL Tip	1000	9,636
A7322	300 µL Tip, sterile	960	10,279
A7632	30 µL TallTip, sterile	960	10,685
A7155	30 µL Filter Tip, sterile	960	14,753
A7432	30 µL 384 Tip, sterile	3840	42,596
A7612-11	10 µL Tip, sterile	Case	10,631
A7635	12.5 µL TallTip Filter Tip, sterile	960	14,591
A7442	125 µL 384 Tip, sterile	3840	46,977
A7325	250 µL Filter Tip, sterile	960	14,665
A7611	10 µL Tip	960	11,478
A7615	10 µL Filter Tip, sterile	960	14,189
A8242-11	1250 µL TallTip, sterile	Case	10,559
A7085	250 µL TallTip Filter Tip, sterile	960	15,288
A8246	1250 µL TallTip ECOTIPS	960	9,985
A7280	250 µL TallTip	500	3,210
A7082	300 µL TallTip, sterile	960	14,400
A8046	1250 µL ECOTIPS	960	10,923
A7081	300 µL TallTip	960	12,787
A8241-11	1250 µL TallTip	Case	10,854
A8245	1250 µL TallTip Filter Tip, sterile	960	15,021
A7621	20 µL Tip	960	18,702
A7425-11	12.5 µL 384 Filter Tip, sterile	Case	50,600
A7445	125 µL 384 Filter Tip, sterile	3840	62,528
A7421	12.5 µL 384 Tip	3840	43,710
A8041-11	1250 µL Tip	Case	19,363
A7435	30 µL 384 Filter Tip, sterile	3840	62,861
A7320	300 µL Tip	1000	6,147
A7610	10 µL Tip	1000	4,972
A7422	12.5 µL 384 Tip, sterile	3840	49,681
A7620	20 µL Tip	1000	4,189
A8250-11	1250 µL TallTip	500	4,118
A7080	300 µL TallTip	500	6,024
A7250	250 µL Tip	1000	4,495
A8055	1250UL INTEGRITY, FIL, ST MTX,	720	40,056
A8050	1250 µL Tip	500	5,438
A7600	30 µL TallTip	1000	6,202
A7275	200 µL Filter Tip, sterile	960	17,275
A7156MX	250 µL ECOTIPS	960	7,422
A8096MX	50 Indiv. wrapped	50	8,120
A320-0500	I-Chem 500ml SS Short Clear Glass Jar certified	12	4,516
AN411-0500	I-Chem 500ml WM Nalgene HDPE Bottle Sterile	40	21,720
A141-0500	I-Chem 500ml WM Amber Packer unprocessed	12	3,333
AS320-0060	I-Chem 60ml Clear short SS Jar with 0.060" septum certified	24	7,634

Cat No.	Description	Packing	Price Rs.
A411-0125	I-Chem 120ml HDPE Sterile Snap-Top Bottle w/o tablet	250	12,151
A329-1000	I-Chem 1L Boston Round Clear Glass Bottle Certified	12	4,516
A349-1000	I-Chem 1L Boston Round Amber Glass Bottle Certified	12	5,054
A156-250PE	EP 250ml polyethylene bottle without tablet	228	65,699
A240-0060	I-Chem 60ml SS Short Amber Glass Jar processed	24	4,194
A339-20A	EP 20ml Vial amber 0.125" bonded septum unprocessed	72	7,312
AS129-0250	I-Chem 250ml NM Clear bottle with 0.125" septum unprocessed	12	2,258
A121-0500	I-Chem 500ml SS Tall Clear Glass Jar unprocessed	12	3,333
A112-0250	I-Chem 250ml HDPE Packer Unprocessed	24	3,656
A114-0001	I-Chem 1 Gallon LDPE Cubitainer® Unprocessed	12	3,978
A112-0950	I-Chem 950ml HDPE Packer Unprocessed	12	3,333
A229-0500	I-Chem 500ml Boston Round Clear Glass Bottle Processed	12	3,011
ASVCS-1-3	Vialservative w/1ml 1:3 H2SO4	24	5,161
A112-4000	I-Chem 4L HDPE Packer Unprocessed	4	2,043
AS346-0060	I-Chem 60ml Vial amber 0.125" unbonded septum certified	72	13,118
A141-60A	EP 60ml vial amber 0.125" bonded septum certified double box	144	26,559
A114-0025	I-Chem 2.5 Gallon LDPE Cubitainer® Unprocessed	12	7,312
AS236-0060	I-Chem 60ml Vial clear 0.125" unbonded septum processed	72	13,011
ASVCS-1-1	Vialservative w/1ml 1:1 H2SO4	24	5,269
A241-0950	I-Chem 950ml WM Amber Packer processed	12	4,839
A249-0500	I-Chem 500ml Boston Round Amber Glass Bottle Processed	12	3,011
A249-0250	I-Chem 250ml Boston Round Amber Glass Bottle Processed	12	2,473
A112-2000	I-Chem 2L HDPE Packer Unprocessed	6	2,688
A114-1000	I-Chem 1 Quart LDPE Cubitainer® Unprocessed	12	3,333
AS121-0250	I-Chem 250ml Clear tall SS Jar with 0.060" septum unprocessed	12	4,624
A220-2000	I-Chem 2L Short Clear Glass Jar processed	6	3,763
A120-0250	I-Chem 250ml SS Short Clear Glass Jar unprocessed	12	3,118
A311-0500	I-Chem 500ml HDPE Jar Certified	24	8,065
A321-1000	I-Chem 1L SS Tall Clear Glass Jar certified	12	5,591
A321-0500	I-Chem 500ml SS Tall Clear Glass Jar certified	12	4,624
A313-0125	I-Chem 125mlHDPE Cylinder Round Certified	48	8,602
AC146-0040	I-Chem 40ml Vial amber closed top unprocessed	72	7,204
A341-40A/DB	EP 40ml Vial amber 0.125" bonded septum unprocessed double box	144	13,763
A316-0125BPC	I-Chem 125ml HDPE Oblong Certified Bulk	500	73,978
AS149-0125	I-Chem 125ml NM Amber bottle with 0.125" septum unprocessed	12	2,151
A067-6300WBP	I-Chem Foam-Lined Polypropylene Cap White 63-400	90	2,473
A349-0125	I-Chem 125ml Boston Round Amber Glass Bottle Certified	12	2,473
A012-0120BP	I-Chem 120ml HDPE Packer Unprocessed Bulk No Cap	540	17,204
AS226-0020	I-Chem 20ml Vial clear 0.125" unbonded septum processed	72	9,785
A229-0250	I-Chem 250ml Boston Round Clear Glass Bottle Processed	12	2,473
AS321-0250	I-Chem 250ml Clear tall SS Jar with 0.060" septum certified	12	4,839
A321-2000	I-Chem 2L Tall Clear Glass Jar certified	6	4,301
A313-0250	I-Chem 250mlHDPE Cylinder Round Certified	24	4,516
A121-0125	I-Chem 125ml SS Tall Clear Glass Jar unprocessed	12	2,903
A341-40A	EP 40ml Vial amber 0.125" bonded septum unprocessed	72	6,989
A141-0250	I-Chem 250ml WM Amber Packer unprocessed	12	3,118
ACTS-13100-SI	13x100 clear glass culture tubes siliconized (caps are not included)	480	30,860
AACN-5	Ampoule w/0.5ml conc HNO3	24	5,269
AAA-SV2-3	2ml amber screw thread open top cap with septa	100	11,935
A340-40C/DB	EP 40ml Vial clear 0.125" bonded septum unprocessed double box	144	12,688
AB267-2414UBB	White 24-414 closed-top cap w/bonded PTFE liner bulk	144	7,742
A313-0500	I-Chem 500mlHDPE Cylinder Round Certified	24	5,484
A141-0950	I-Chem 950ml WM Amber Packer unprocessed	12	4,194
AB167-3800BL	White 38-400 closed-top cap w/bonded PTFE liner bulk	24	1,075
AACS-2	Ampoule w/2ml conc H2SO4	24	5,376
A121-0250	I-Chem 250ml SS Tall Clear Glass Jar unprocessed	12	3,118
ASVCN-1	Vialservative w/1ml conc HNO3	24	5,914
ASVCN-2-1	Vialservative w/2ml 1:1 HNO3	24	5,914

Cat No.	Description	Packing	Price Rs.
ASVCS-.5	Vialservative w/0.5ml conc H2SO4	24	5,914
AS349-1000	I-Chem 1L NM Amber bottle with 0.125" septum certified	12	5,699
AC226-0020	I-Chem 20ml Vial clear closed top processed	72	10,645
A140-0120	I-Chem 120ml SS Short Amber Glass Jar unprocessed	24	3,118
AS320-0125	I-Chem 125ml Clear short SS Jar with 0.060" septum certified	24	8,602
A312-2000BPC	I-Chem 2L HDPE Packer Certified Bulk	35	15,806
A349-0250	I-Chem 250ml Boston Round Amber Glass Bottle Certified	12	2,796
A312-0250BPC	I-Chem 250ml HDPE Packer Certified Bulk	280	45,269
ASVCS-2	Vialservative w/2ml conc H2SO4	24	6,022
A329-0500	I-Chem 500ml Boston Round Clear Glass Bottle Certified	12	3,548
ASVCN-2	Vialservative w/2ml conc HNO3	24	6,129
A340-40C	EP 40ml Vial clear 0.125" bonded septum unprocessed	72	7,097
A221-2000	I-Chem 2L Tall Clear Glass Jar processed	6	3,763
A341-0500	I-Chem 500ml WM Amber Packer certified	12	4,624
A329-0250	I-Chem 250ml Boston Round Clear Glass Bottle Certified	12	2,796
AB167-2800BL	White 28-400 closed-top cap w/bonded PTFE liner bulk	24	860
AS336-0060	I-Chem 60ml Vial clear 0.125" unbonded septum certified	72	15,376
A341-0950	I-Chem 950ml WM Amber Packer certified	12	5,699
A013-0250BP	I-Chem 250mlHDPE Cylinder Round Unprocessed Bulk No Cap	230	11,075
AB167-5300BL	White 53-400 closed-top cap w/bonded PTFE liner bulk	24	1,613
A349-0500	I-Chem 500ml Boston Round Amber Glass Bottle Certified	12	3,548
A220-0250	I-Chem 250ml SS Short Clear Glass Jar processed	12	3,656
A320-2000	I-Chem 2L Short Clear Glass Jar certified	6	4,409
ASB46-0040	I-Chem 40ml Vial amber 0.125" unbonded septum processed bulk gtg	144	17,097
A316-0500	I-Chem 500ml HDPE Oblong Certified	24	6,237
A121-2000	I-Chem 2L Tall Clear Glass Jar unprocessed	6	3,226
A120-0060	I-Chem 60ml SS Short Clear Glass Jar unprocessed	24	5,269
A314-1000	I-Chem 1 Quart LDPE Cubitainer® Certified	12	5,376
AACN-5-1	Ampoule w/5ml 1:1 HNO3	24	5,591
AB167-3300BL	White 33-400 closed-top cap w/bonded PTFE liner bulk	24	1,183
AB167-8900BL	White 89-400 closed-top cap w/bonded PTFE liner bulk	24	3,441
A115-4000	I-Chem 4L HDPE Jug Unprocessed	6	2,151
AC136-0040	I-Chem 40ml Vial clear closed top unprocessed	72	8,602
A221-0125	I-Chem 125ml SS Tall Clear Glass Jar processed	12	3,441
AS136-0040	I-Chem 40ml Vial clear 0.125" unbonded septum unprocessed	72	7,849
A24-414/WS-3M	White 24-414 open-top closure with bonded 0.125" septum	1000	43,226
AS297-5800	White 58-400 open-top closure w/0.060" bonded septum	24	6,344
AS349-0250	I-Chem 250ml NM Amber bottle with 0.125" septum certified	12	3,118
A121-4000	I-Chem 4L Tall Clear Glass Jar unprocessed	4	4,301
AS326-0020	I-Chem 20ml Vial clear 0.125" unbonded septum certified	72	12,151
AACH-5-1	Ampoule w/5ml 1:1 HCL	24	5,914
AACN-5	Ampoule w/5ml conc HNO3	24	5,914
A141-40A/DB	EP 40ml Vial amber 0.125" bonded septum certified double box	144	17,312
AS329-0250	I-Chem 250ml NM Clear bottle with 0.125" septum certified	12	3,118
AS349-0125	I-Chem 125ml NM Amber bottle with 0.125" septum certified	12	2,796
ASB36-0040	I-Chem 40ml Vial clear 0.125" unbonded septum processed bulk gtg	144	17,204
ASS246-0040	I-Chem 40ml amber vial 0.125" bonded septum processed Clean Snap	72	10,968
A340-0120	I-Chem 120ml SS Short Amber Glass Jar certified	24	3,763
A140-0250NC	I-Chem 250ml SS Short Amber Glass Jar unprocessed No Cap	24	3,226
A140-0060	I-Chem 60ml SS Short Amber Glass Jar unprocessed	24	5,806
A221-0250	I-Chem 250ml SS Tall Clear Glass Jar processed	12	3,763
ASS236-0040	I-Chem 40ml clear vial 0.125" bonded septum processed Clean Snap	72	10,968
ASVCH-5-1	Vialservative w/5ml 1:1 HCL	24	6,667
ASVCN-5	Vialservative w/5ml conc HNO3	24	6,667
APP140-40CEPSBTB	40ml clear septa vial w/5mL Sodium Bisulfate, Stir Bar, Tare Weighed	72	36,882
AC326-0020	I-Chem 20ml Vial clear closed top certified	72	13,011
AS340-0120	I-Chem 120ml Amber short SS Jar with 0.060" septa certified	24	8,817

Cat No.	Description	Packing	Price Rs.
AS297-5300	White 53-400 open-top closure w/0.060" bonded septum	24	6,882
A140-40C/DB	EP 40ml Vial clear 0.125" bonded septum certified double box	144	17,419
AB167-7000BL	White 70-400 closed-top cap w/bonded PTFE liner bulk	24	2,581
APP140-40CEPPTTW	40mL clear septa vial w/10mL Methanol, Tare Weighed	72	28,710
AS246-0040	I-Chem 40ml Vial amber 0.125" unbonded septum processed	72	10,000
A320-0250	I-Chem 250ml SS Short Clear Glass Jar certified	12	4,301
AB167-4500BL	White 45-400 closed-top cap w/bonded PTFE liner bulk	24	1,505
A297-2400UB	White 24-414 open-top closure w/0.060" bonded septum	24	1,505
ALB236-0040	I-Chem 40ml Vial clear 0.125" unbonded Low Bleed septum processed	72	11,720
A241-0500	I-Chem 500ml WM Amber Packer processed	12	4,086
AP140-40CEPPTTW	40mL clear septa vial w/5mL Methanol, Tare Weighed	72	28,710
AB167-5800BL	White 58-400 closed-top cap w/bonded PTFE liner bulk	24	2,151
A321-0125	I-Chem 125ml SS Tall Clear Glass Jar certified	12	3,978
AC246-0040	I-Chem 40ml Vial amber closed top processed	72	10,860
A220-0060	I-Chem 60ml SS Short Clear Glass Jar processed	24	6,344
AV349-1000	Narrow-Mouth Closed Top VOA Bottles	12	12,151
ADC-VOA	Dust Cover for 24-414 Septa Caps	500	7,849
A156-120ST	EP 120ml polystyrene bottle without tablet	200	53,656
A120-0125	I-Chem 125ml SS Short Clear Glass Jar unprocessed	24	5,914
A067-2410WBP	I-Chem Foam-Lined Polypropylene Cap White 24-410	250	5,161
ASS346-0040	I-Chem 40ml amber vial 0.125" bonded septum certified Clean Snap	72	12,473
A156-120PP	EP 120ml polypropylene bottle without tablet	200	48,387
A221-4000	I-Chem 4L Tall Clear Glass Jar processed	4	5,161
A067-5300WBP	I-Chem Foam-Lined Polypropylene Cap White 53-400	200	5,484
AT136-0040	I-Chem 40ml Vial clear 0.060" bonded septum unprocessed	72	10,323
A321-0250	I-Chem 250ml SS Tall Clear Glass Jar certified	12	4,409
A340-0060	I-Chem 60ml SS Short Amber Glass Jar certified	24	6,989
A139-20C/EP	EP 20ml Vial clear 0.125" bonded septum certified	72	11,505
A241-0250	I-Chem 250ml WM Amber Packer processed	12	3,763
A288-0022BP	Septum 0.125" thick for 24-414 closures processed	2000	82,366
A067-4800WBP	I-Chem Foam-Lined Polypropylene Cap White 48-400	250	6,237
A139-20C	EP 20ml vial clear 0.125" bonded septum premium pack certified	72	12,581
A312-4000	I-Chem 4L HDPE Packer Certified	4	3,548
AC236-0040	I-Chem 40ml Vial clear closed top processed	72	12,258
AS236-0040	I-Chem 40ml Vial clear 0.125" unbonded septum processed	72	11,398
A320-0060	I-Chem 60ml SS Short Clear Glass Jar certified	24	7,312
ASS336-0040	I-Chem 40ml clear vial 0.125" bonded septum certified Clean Snap	72	13,871
A139-20A	EP 20ml vial amber 0.125" bonded septum premium pack certified	72	12,581
AS346-0040	I-Chem 40ml Vial amber 0.125" unbonded septum certified	72	12,366
A220-0125	I-Chem 125ml SS Short Clear Glass Jar processed	24	6,989
A139-20A/EP	EP 20ml Vial amber 0.125" bonded septum certified	72	11,613
A321-4000	I-Chem 4L Tall Clear Glass Jar certified	4	6,022
A141-40A	EP 40ml vial amber 0.125" bonded septum premium pack certified	72	13,871
A141-0060	I-Chem 60ml WM Amber Packer unprocessed	24	5,376
AC346-0020	I-Chem 20ml Vial amber closed top certified	72	13,226
A141-40A/EP	EP 40ml Vial amber 0.125" bonded septum certified	72	13,011
A315-4000	I-Chem 4L HDPE Jug Certified	6	3,548
AS40300	SERUM VIAL PRECAPPED RED 2000/	2000	36,004
A139-20A/CT	EP 20ml Amber vial with closed top premium pack certified	72	14,086
A341-0250	I-Chem 250ml WM Amber Packer certified	12	4,409
A341-1250	I-Chem 1250ml WM Amber Packer certified	6	8,172
AGVB-100C	40 mL clear vial	100	22,043
AC346-0040	I-Chem 40ml Vial amber closed top certified	72	14,516
A241-0120	I-Chem 120ml WM Amber Packer processed	12	3,548
A067-2810WBP	I-Chem Foam-Lined Polypropylene Cap White 28-410	200	4,731
AC336-0040	I-Chem 40ml Vial clear closed top certified	72	14,516

Cat No.	Description	Packing	Price Rs.
A139-20C/CT	EP 20ml Clear vial with closed top premium pack certified	72	14,194
A140-40C	EP 40ml vial clear 0.125" bonded septum premium pack certified	72	13,978
A240-0120	I-Chem 120ml SS Short Amber Glass Jar processed	24	5,484
A140-40C/EP	EP 40ml Vial clear 0.125" bonded septum certified	72	13,118
AS336-0040	I-Chem 40ml Vial clear 0.125" unbonded septum certified	72	13,871
A320-0125	I-Chem 125ml SS Short Clear Glass Jar certified	24	8,065
ALB336-0040	I-Chem 40ml Vial clear 0.125" unbonded Low Bleed septum certified	72	16,989
A141-0120	I-Chem 120ml WM Amber Packer unprocessed	12	3,011
ASS326-0020	I-Chem 20ml clear vial 0.125" bonded septum certified Clean Snap	72	12,688
AT236-0040	I-Chem 40ml Vial clear 0.060" bonded septum processed	72	15,054
AGVB-100A	40 mL amber vial	100	27,849
A314-0005	I-Chem 5 Gallon LDPE Cubitainer® Certified	4	5,161
A241-0060	I-Chem 60ml WM Amber Packer processed	24	6,452
A341-0120	I-Chem 120ml WM Amber Packer certified	12	4,086
A314-0025	I-Chem 2.5 Gallon LDPE Cubitainer® Certified	12	9,570
A141-40A/TS	EP 40ml vial amber 0.060" bonded septum premium pack certified	72	18,065
AN301-0500	I-Chem Nalgene 500ml Amber WM Bottle Certified	48	14,624
AN311-0500	I-Chem Nalgene 500ml Natural WM Bottle Certified	48	14,624
A140-40C/TS	EP 40ml vial clear 0.060" bonded septum premium pack certified	72	18,065
AN301-1000	I-Chem Nalgene 1L Amber WM Bottle Certified	24	10,860
A141-40A/CT	EP 40ml Amber vial with closed top premium pack certified	72	17,634
A288-7222	Septum 0.125" thick for 24-414 closures processed	72	4,839
A341-0060	I-Chem 60ml WM Amber Packer certified	24	7,419
AN311-1000	I-Chem Nalgene 1L Natural WM Bottle Certified	24	10,645
A314-0001	I-Chem 1 Gallon LDPE Cubitainer® Certified	12	7,849
AN319-0125	I-Chem Nalgene 125ml Natural NM Bottle Certified	72	14,421
A140-40C/CT	EP 40ml Clear vial with closed top premium pack certified	72	17,742
AN311-0250	I-Chem Nalgene 250ml Natural WM Bottle Certified	72	18,280
AN311-0125	I-Chem Nalgene 125ml Natural WM Bottle Certified	72	14,839
AN301-0125	I-Chem Nalgene 125ml Amber WM Bottle Certified	72	14,839
A067-3800WBP	I-Chem Foam-Lined Polypropylene Cap White 38-400	500	12,258
AN301-0250	I-Chem Nalgene 250ml Amber WM Bottle Certified	72	18,280
A312-0120	I-Chem 120ml HDPE Packer Certified Bulk	48	8,710
AN319-0250	I-Chem Nalgene 250ml Natural NM Bottle Certified	72	17,789
A315-2000	I-Chem 2L HDPE Jug Certified	6	3,333
AN319-0500	I-Chem Nalgene 500ml Natural NM Bottle Certified	48	14,409
AS241-0060	I-Chem 60ml Amber Packer with 0.060" septum processed	24	13,011
A297-2414	White 24-414 open-top closure without septum	24	860
ASS146-0040	I-Chem 40ml amber vial 0.125" bonded septum unprocessed Clean Snap	72	10,430
AN319-1000	I-Chem Nalgene 1L Natural NM Bottle Certified	24	9,895
A288-0022	Septum 0.125" thick for 24-414 closures processed	24	2,688
ASS136-0040	I-Chem 40ml clear vial 0.125" bonded septum unprocessed Clean Snap	72	10,430
A500	1"X7" Thermo Scientific Custody Seals	100	3,333
A503-0004	Sulfuric Acid	1000	7,419
A503-0005	Nitric Acid	1000	7,419
A503-0007	Hydrochloric Acid	1000	7,419
A503-0009	Sodium Thiosulfate	1000	7,419
A503-0008	Sodium Hydroxide	1000	7,527
A503-0010	Short Holding Time	1000	7,527
A503-0006	Zinc Acetate/Sodium Hydroxide	1000	7,527
ASG-003	Environmental Sampling Guide	Each	323
A5840320	Multidrop Combi with SMART 2 option, 100-240 V 50/60 Hz Includes cassette lifetime traceability feature	Each	2,780,867
A24073291	Small tube plastic tip dispensing cassette 5-pack	Each	408,719
A24072670	Standard tube dispensing cassette (for volumes 5-2500 µl)	Each	93,590
A24073295	Small tube metal tip dispensing cassette (for volumes 0.5-50 µl)	Each	93,590
A5840300	Multidrop Combi, 100-240 V 50/60 Hz 9)	Each	2,465,638
A24073296	Small tube metal tip dispensing cassette 5-pack	Each	400,204

Cat No.	Description	Packing	Price Rs.
A24072671	Standard tube dispensing cassette 5-pack	Each	408,719
A24073290	Small tube plastic tip dispensing cassette (for volumes 0.5–50 µl)	Each	95,581
A24073293	Long small tube plastic tip dispensing cassette (for volumes 0.5–50 µl)	Each	101,580
A24073298	Long small tube metal tip dispensing cassette (for volumes 0.5–50 µl)	Each	101,580
A24072672	Standard tube dispensing cassette 5-pack	Each	583,484
A24072677	Standard tube dispensing cassette 10-pack	Each	136,773
AN15133	SMART 2 small tube plastic tip dispensing cassette, new RFID tag	Each	105,179
AN15134	SMART 2 small tube plastic tip dispensing cassette 5-pack, new RFID tag	Each	449,910
AN15135	SMART 2 small tube metal tip dispensing cassette, new RFID tag	Each	105,179
AN15136	SMART 2 small tube metal tip dispensing cassette 5-pack, new RFID tag	Each	449,910
AN15137	SMART 2 standard tube dispensing cassette, new RFID tag	Each	105,179
AN15138	SMART 2 standard tube dispensing cassette 5-pack, new RFID tag	Each	449,910
AN15139	SMART 2 long standard tube dispensing cassette (length of tubing 50–200 cm in 10 cm increments), new RFID tag	Each	137,773
A5840310	Multidrop Combi with SMART option, 100-240 V 50/60 Hz 10)	Each	2,840,035
A5840400	Multidrop Combi nL, 100-240V 50/60Hz	Each	5,304,944
A5188019	FILLit software for Multidrop Combi nL	Each	297,941
A650-01-BS	Versette Base Unit	Each	3,617,825
A650-02-NTC	96- and 384- Head Housing Assembly, Versette	Each	1,770,920
A650-03-SPS	Six Position Stage, Versette	Each	2,204,652
A650-06-9630	96-channel air displacement pipetting head. Volume 0.5-30 µl	Each	4,115,181
A650-06-96300	96-channel air displacement pipetting head. Volume 5-300 µl	Each	4,115,181
A650-06-384100	384-channel air displacement pipetting head. Volume 1–100 µl	Each	6,547,060
A650-04-PUMP	Pump module	Each	1,389,542
A650-05-96TTW	96-channel tip wash station, tall	Each	793,660
A650-05-384TTW	384-channel tip wash station, tall	Each	944,539
A650-08-9630SD	Serial dilute magazine 96/30 µl (8/12)	Each	127,247
A650-08-9630XL	Serial dilute magazine 96/30 µl (8/12)	Each	127,247
A650-08-384SD	Serial dilute magazine 384/30&100 µl (16/24)	Each	155,605
A4640060	F3 100-1000µl	Each	7,887
A4642090	F2 SC Variable Volume 100-1000 µL	Each	12,158
A4640040	F3 10-100µl	Each	7,887
A4640050	F3 20-200µl	Each	7,887
A4640090	F3 5-50µl Universal	Each	7,887
A4642080	F2 SC Variable Volume 20-200 µL	Each	12,158
A4650080	F3 Fixed Volume 1000µl	Each	4,588
A4640030	F3 2-20µl Universal	Each	7,887
A4642070	F2 SC Variable Volume 10-100 µL	Each	12,158
A4642060	F2 SC Variable Volume 2-20 µL	Each	12,158
A4640010	F3 1-10µl Universal	Each	7,887
A4662030	F2 MC8 Variable Volume 30-300 µL	Each	30,515
A4642100	F2 SC Variable Volume 0.5-5 mL	Each	12,158
A4642010	F2 SC Variable Volume 0.2-2 µL, micro	Each	12,158
A4650050	F3 Fixed Volume 100µl	Each	4,588
A4650020	F3 Fixed Volume 10µl	Each	4,588
A4640100	F3 0.5-5ml	Each	7,887
A4642040	F2 SC Variable Volume 1-10 µL	Each	12,158
A4650070	F3 Fixed Volume 500µl	Each	4,588
A4640070	F3 1-10ml	Each	7,887
A4642110	F2 SC Variable Volume 1-10 mL	Each	12,158
A4650040	F3 Fixed Volume 50µl	Each	4,588
A4642130	F2 SC Variable Volume 5- 50 µL	Each	12,158
A4652080	F2 Fixed 1000 µL	Each	5,928
A4642030	F2 SC Variable Volume 1-10 µL, micro	Each	12,158
A4642020	F2 SC Variable Volume 0.5-5 µL, micro	Each	12,158
A4662020	F2 MC8 Variable Volume 10-100 µL	Each	30,515
A4650100	F3 Fixed Volume 200µl	Each	4,684
A4642050	F2 SC Variable Volume 2-20 µL, micro	Each	12,158

Cat No.	Description	Packing	Price Rs.
A4662000	F2 MC8 Variable Volume 1-10 µL	Each	30,515
A4662010	F2 MC8 Variable Volume 5-50 µL	Each	30,515
A4662070	F2 MC12 Variable Volume 30-300 µL	Each	33,299
A4650090	F3 Fixed Volume 20µl	Each	4,684
A4640000	F3 1-10µl Micro	Each	8,053
A4652110	F2 Fixed 5000 µL	Each	6,053
A4652080N	Finnpipette F2 Fix. Vol. 1000µl	Each	6,828
A4652020N	Finnpipette F2 Fix.Vol. 10µl	Each	6,828
A4652050N	Finnpipette F2 Fix. Vol. 100µl	Each	6,828
A4652110N	Finnpipette F2 Fix. Vol. 5ml	Each	6,828
A4652140N	Finnpipette F2 Fix. Vol. 200µl	Each	6,828
A4652040N	Finnpipette F2 Fix. Vol. 50µl	Each	6,828
A4652120N	Finnpipette F2 Fix. Vol. 10ml	Each	6,828
A4652070N	Finnpipette F2 Fix. Vol. 500µl	Each	6,828
A4652130N	Finnpipette F2 Fix. Vol. 20µl	Each	6,828
A4652000N	Finnpipette F2 Fix.Vol. 1µl Tip	Each	6,828
A4652030N	Finnpipette F2 Fix.Vol. 25µl	Each	6,828
A4652010N	Finnpipette F2 Fix.Vol. 5µl µTip	Each	6,828
A4652100N	Finnpipette F2 Fix. Vol. 3ml	Each	6,828
A4652060N	Finnpipette F2 Fix. Vol. 250µl	Each	6,828
A4652090N	Finnpipette F2 Fix. Vol. 2ml	Each	6,828
A4650010	F3 Fixed Volume 5µl Micro	Each	4,684
A4652090	F2 Fixed 2000 µL	Each	5,802
A4652050	F2 Fixed 100µl	Each	5,802
A4640080	F3 5-50µl Micro	Each	8,053
A4652020	F2 Fixed 10 µL	Each	6,053
A4640020	F3 2-20µl Micro	Each	8,053
A4652120	F2 Fixed 10000 µL	Each	6,053
A4650030	F3 Fixed Volume 25µl	Each	4,684
A4642120	F2 SC Variable Volume 5-50 µL, mico	Each	12,158
A4642090N	Finnpipette F2 100-1000 µl	Each	13,346
A4642080N	Finnpipette F2 20-200 µl	Each	13,346
A4642070N	Finnpipette F2 10-100 µl	Each	13,346
A4642060N	Finnpipette F2 2-20 µl	Each	13,346
A4642100N	Finnpipette F2 0,5-5 ml	Each	13,346
A4642040N	Finnpipette F2 1-10 µl	Each	13,346
A4642130N	Finnpipette F2 5-50 µl	Each	13,346
A4642110N	Finnpipette F2 1-10 ml	Each	13,346
A4642030N	Finnpipette F2 1-10 µl µTip	Each	13,346
A4642050N	Finnpipette F2 2-20 µl µTip	Each	13,346
A4642120N	Finnpipette F2 5-50 µl µTip	Each	13,346
A4650060	F3 Fixed Volume 250µl	Each	4,684
A4652100	F2 Fixed 3000 µL	Each	6,053
A4640060N	F3 100-1000µl	Each	8,830
A4662060	F2 MC12 Variable Volume 10-100 µL	Each	34,000
A4662030N	Finnpipette F2 8-ch. 30-300µl	Each	34,105
A4662020N	Finnpipette F2 8-ch. 10-100µl	Each	34,105
A4662010N	Finnpipette F2 8-ch. 5-50µl	Each	34,105
A4662000N	Finnpipette F2 8-ch. 1-10µl	Each	34,105
A4662050	F2 MC12 Variable Volume 5-50 µL	Each	34,000
A4652070	F2 Fixed 500 µL	Each	6,053
A4662040N	Finnpipette F2 12-ch. 1-10µl	Each	35,089
A4650000N	F3 - 1 µl Micro	Each	5,429
A4650060N	F3 - 250 µl	Each	5,429
A4650030N	F3 - 25 µl	Each	5,429
A4650090N	F3 - 20 µl	Each	5,429
A4650100N	F3 - 200 µl	Each	5,429
A4650010N	F3 - 5 µl Micro	Each	5,429

Cat No.	Description	Packing	Price Rs.
A4650040N	F3 - 50 µl	Each	5,429
A4650020N	F3 - 10 µl	Each	5,429
A4650050N	F3 - 100 µl	Each	5,429
A4652030	F2 Fixed 25 µL	Each	6,053
A4652040	F2 Fixed 50 µL	Each	6,053
A4662070N	Finnpipette F2 12-ch. 30-300µl	Each	37,330
A4662060N	Finnpipette F2 12-ch. 10-100µl	Each	37,330
A4662050N	Finnpipette F2 12-ch. 5-50µl	Each	37,330
A4652010	F2 Fixed 5 µL	Each	6,053
A4640080N	F35-50 µl Micr	Each	9,032
A4640020N	F3 2-20µl	Each	9,032
A4640000N	F3 1-10µl micro	Each	9,032
A4640030N	F3 2-20µl UNIV	Each	9,032
A4640100N	F3 0.5 -5 mL	Each	9,032
A4640070N	F3 1-10ml	Each	9,032
A4640010N	F3 1-10µl UNIV	Each	9,032
A4640090N	F35-50 µl	Each	9,032
A4640040N	F3 10-100µl	Each	9,032
A4652130	F2 Fixed 20 µL	Each	6,053
A4652060	F2 Fixed 250 µL	Each	6,053
A4652000	F2 Fixed 1 µL	Each	6,053
A4650000	F3 Fixed Volume 1µl Micro	Each	4,684
A4640050N	F3 20-200µl	Each	9,032
A4652140	F2 Fixed 200 µL	Each	6,053
A4650070N	F3 - 500 µl	Each	5,429
A4650080N	F3 - 1000 µl	Each	5,429
A4640060-N	F3 100-1000µl	Each	8,138
A4642090-N	F2 SC Variable Volume 100-1000 µL	Each	12,287
A4640050-N	F3 20-200µl	Each	8,138
A4642080-N	F2 SC Variable Volume 20-200 µL	Each	12,287
A4650080-N	F3 Fixed Volume 1000µl	Each	4,734
A4642070-N	F2 SC Variable Volume 10-100 µL	Each	12,287
A4642060-N	F2 SC Variable Volume 2-20 µL	Each	12,287
A4662030-N	F2 MC8 Variable Volume 30-300 µL	Each	31,489
A4642040-N	F2 SC Variable Volume 1-10 µL	Each	12,287
A4650070-N	F3 Fixed Volume 500µl	Each	4,734
A4652080-N	F2 Fixed 1000 µL	Each	6,117
A4642030-N	F2 SC Variable Volume 1-10 µL, micro	Each	12,287
A4662020-N	F2 MC8 Variable Volume 10-100 µL	Each	31,489
A4642050-N	F2 SC Variable Volume 2-20 µL, micro	Each	12,287
A4662000-N	F2 MC8 Variable Volume 1-10 µL	Each	31,489
A4640080-N	F3 5-50µl Micro	Each	8,138
A4662060-N	F2 MC12 Variable Volume 10-100 µL	Each	34,362
A4640040-N	F3 10-100µl	Each	9,032
ATSRBGE029	SILESCOL TSR BUNGS E29	Each	1,183
ATSRBGE067	SILESCOL TSR BUNGS E67	Each	5,591
ATSRBGE033	SILESCOL TSR BUNGS E33	Each	1,613
ATSRBGE037	SILESCOL TSR BUNGS E37	Each	1,613
ATSRBGE041	SILESCOL TSR BUNGS E41	Each	2,258
AGSR0800160P	GSR TUBE 8.00X1.60MMX15M COIL	Meter	12,366
ATDSC0560016	TSR DISC 56.0X1.6MM PKT100	Each	33,011
APKRD0379063	RWH DISCS 37.9 X 6.3MM PK100	Each	29,247
ASR7SHT1515180	SR70 SHEET 15" X 15" X 1/8"	Each	11,290
ATSRBGE025	SILESCOL TSR BUNGS E25	Each	1,075
ATSRPR0250036P	PRECISION TUBE 0.0025X0.036"	CO	9,892
A121V	30MM PETRI DISH 3 VENT	800	18,065
ATSRBGE021	SILESCOL TSR BUNGS E21	Each	968
A501V	140MM PETRI DISH 3 VENT	80	3,978

Cat No.	Description	Packing	Price Rs.
ATSRPR0450036P	PRECISION TUBE 0.045X0.036"	CO	10,430
AZ10PSNL	10ML PS SCREW CAP TUBE NO LAB	Case	14,731
ATSR0850400P	TSR TUBE 8.50X4.00MMX15M COIL	Meter	34,194
A202-1S	Samco 7.7mL General Purpose Transfer Pip	4000	17,634
ABLKTTS2	BLACK TEST TUBE HOLDER TTS2	Each	7,742
AGSR1250240P	GSR TUBE 12.50X2.4MMX15M COIL	Case	25,591
ATSR0800240P	TSR TUBE 8.0X2.40MMX15M COIL	Meter	18,710
AGSR1000300P	GSR TUBE 10.00X3.00MMX15M COIL	Meter	17,097
AGSR1600320P	GSR TUBE 16.00X3.20MMX15M COIL	Meter	28,602
AGSR0630320P	GSR TUBE 6.30X3.20MMX15M COIL	Meter	15,484
AGSR0630160P	GSR TUBE 6.30X1.60MMX15M COIL	Meter	16,882
ATSR0900320P	TSR TUBE 9.00X3.20MMX15M COIL	Meter	26,344
AGSR2540320P	GSR TUBE 25.4X3.20MMX15M COIL	Meter	65,591
ATSRPR0510036P	PRECISION TUBE 0.051X0.036"	CO	11,505
ATSR0800400P	TSR TUBE 8.00X4.00MMX15M COIL	Meter	33,978
ATSR0800500P	TSR TUBE 8.00X5.00MMX15M COIL	Meter	37,204
A101RT/IRR	90MM PETRI DISH 0 VENT IRRAD	500	6,452
A101V/IRR	90MM PETRI DISH 3 VENT IRRAD	500	6,452
AGSR0900400P	GSR TUBE 9.00X4.00MMX15M COIL	Meter	19,570
APRMPR152091P	PRECISION TUBE 1.52X0.91MM	CO	10,860
ATSRBGE008	SILESCOL TSR BUNGS E8 PK10	Each	3,011
AGSR0200050P	GSR TUBE 2.00X0.50MMX15M COIL	Meter	9,892
ATSRBGE017	SILESCOL TSR BUNGS E17 PK10	Each	4,194
ATSRBGE005	SILESCOL BUNGS E5 PK10	Each	2,688
A165A	150ML CONT NO LABEL	120	12,796
ATSRBGE049	SILESCOL TSR BUNGS E49	Each	3,871
AGSR0400160P	GSR TUBE 4.00X1.60MMX15M COIL	Meter	8,925
AGSR1900320P	GSR TUBE 19.00X3.20MMX15M COIL	Meter	39,570
ATSRPR1100036P	PRECISION TUBE 0.110X0.036"	CO	12,688
AGSR0300200P	GSR TUBE 3.00X2.00MMX15M COIL	Meter	8,495
A129A	7ML BIJOU NOLABEL	Case	11,720
A125AM	60MLCONTNO LABEL MC	300	11,183
APKRD0140048	RWH DISCS 14.0 X 4.88MM PK100	Each	11,505
ATSRBGE030	SILESCOL TSR BUNGS E30	Each	2,043
AGSR0500160P	GSR TUBE 5.00X1.60MMX15M COIL	Meter	12,688
APKRD0317563	RWH DISCS 31.75 X 6.3MM PK100	Each	26,559
ATSRBGE019	SILESCOL TSR BUNGS E19 PK10	Each	5,054
AGSR0600200P	GSR TUBE 6.00X2.00MMX15M COIL	Meter	15,376
AGSR0400200P	GSR TUBE 4.00X2.00MMX15M COIL	Meter	16,129
ATSRBGE045	SILESCOL TSR BUNGS E45	Each	3,763
ATSRBGE053	SILESCOL TSR BUNGS E53	Each	6,022
ATSRBGE006	SILESCOL BUNGS E6 PK10	Each	3,011
ATSRBGE007	SILESCOL TSR BUNGS E7 PK10	Each	3,011
ATDSC0254032	TSR DISC 25.4X3.2MM PKT100	Each	16,559
AGSR0150100P	GSR TUBE 1.50X1.00MMX15M COIL	Meter	8,280
ATDSC0220032	TSR DISC 22.0MMX3.2MM PK100	Each	14,301
APKRD0404063	RWH DISCS 40.4 X 6.3MM PK100	Case	36,559
AGSR0250100P	GSR TUBE 2.50X1.00MMX15M COIL	Meter	9,247
ATSRBGN10A	SILESCOL TSR BUNGS 10A PK10	Each	3,978
ATSRBGE009	SILESCOL TSR BUNGS E9 PK10	Each	3,441
ATSRBGE027	SILESCOL TSR BUNGS E27	Each	1,720
ATSRBGE057	SILESCOL TSR BUNGS E57	Each	6,344
ABLKTTS3	BLACK TEST TUBE HOLDER TTS3	Each	10,968
A191BLUE	30MLDIPPA SAMPLER&HAND(BLUE)	50	14,409
A191	30MLDIPPA SAMPLER&HANDLE	5000	14,409
AD1	BLOOD TRANS BAG PLUGS	Case	20,000
A190A	250ML CONTAINER NO LABEL	Case	5,269
A194IWB/LUE	100ML DIPPA & HANDLE I/W(BLUE)	Case	38,387

Cat No.	Description	Packing	Price Rs.
A147A	CAP 142B/144B PUSH FIT - BLUE	1200	19,570
A194IW	100ML DIPPA & HANDLE I/W	100	37,957
AZ5PE	5ML PP SCREW CAP TUBE LABELLED	Case	60,860
AZ5PENL	5ML PP SCREW CAP TUBE NO LABEL	Case	43,656
AC2A	CAP NA2/RT30 PUSH FIT	Case	19,677
AZ10PENL	10ML PP SCREW CAP TUBE NO LAB	Case	23,118
A7078B-1	1ML SHORT PIPETTE BULK WRAP	Case	58,602
A165PYR	150ML CONT NON-PYROGENIC	120	27,097
A133NSM	10ML PIP NO PLUG NS 16 * 50 MP	Case	27,634
AZ10PE	10ML PP SCREW CAP TUBE & LABEL	Case	32,473
ART20	TEST TUBE 50 * 6MM R.BASE	Case	46,989
ART25	TEST TUBE 65 * 10MMR.BASE	Case	39,570
A192	250ML DIPPA SAMPLER&HANDLE	Case	23,763
A99445-18	TUBE GLASS CULTUREDISEPOSABLE	Case	13,333
A7078B-50	50ML SHORT PIPETTE BULK WRAP	Case	33,226
A99999-18	SCREW CAP RUBBER LINER 20MM	Case	26,559
AM00975	30ML UNI CONTAINER PLAIN LABEL	Case	11,828
A128C	30ML UNI PLN LBL QUICKSTART CP	Case	7,849
A190DB/IRR	250ML CONT PTD LABEL D/BAG I/W	40	35,376
A193A	250ML CONTAINER NOLABEL PP	Case	9,677
A501V/IRR	140MM PETRI DISH 3 VENTIRRAD	80	11,935
AZ5PSNL	5ML PS SCREW CAP TUBE NO LABEL	1000	22,473
AZ10PS	10ML PS SCREW CAP TUBE & LABEL	Case	24,086
A500WSCNT	WATER SAMPLE CONT 500ML NT IRR	70	21,613
A99448-19	TUBE GLASS CULTUREDISEPOSABLE	Case	40,860
AM00810	SMALL DIAGNOSTIC HOUS, NO LOGO	Case	12,258
A9998-15	SCREW CAP PTFE LINER AUTOCLAVA	Case	25,591
A500WSC	WATER SAMPLING CONT 500MLIRR	Case	25,484
AM00845	60ML CONT PLASTIC CP PTD LABEL	Case	13,548
A129PYR	7ML BIJOU NON-PYROGENIC	700	33,763
ART30	TEST TUBE 75 * 12MMR.BASE	Case	18,710
A99449-16XX	TUBE GLASS CULTUREDISEPOSABLE	Case	73,548
A100CTP	CAPPED T.C.TUBE 17 X 100MMPP	Case	24,409
A100CTS	CAPPED T.C.TUBE 17 X 100MPS	Case	24,409
A75CTP	CAPPED T.C.TUBE 12 X 75MMPP	Case	16,559
A75CTS	CAPPED T.C.TUBE 12 X 75MM PS	Case	16,559
A75CTS1	75MM*12MM PS TUBE IND.WRAP	Case	22,581
A100CTP1	100MM*17MM PP TUBE IND.WRAP	Case	28,710
A100CTS1	100MM*17MM PS TUBE IND.WRAP	Case	28,710
AWSC500-20	500ML SQUARE BOT DOSED 20MG	Case	23,871
A99448-16	TUBE GLASS CULTUREDISEPOSABLE	Case	67,957
A125BM/50	60ML CONT PTD LABEL BAGS 50	Case	9,570
A99449-16X	TUBE GLASS CULTUREDISEPOSABLE	Case	68,710
A190PYR	250ML CONTAINER NON-PYROGENIC	50	16,559
A125PYR	60MLCONTNON-PYROGENIC	300	30,000
A125BP	60MLCONTPTD LABELPC	Case	10,323
A125AP	60ML CONT NO LABEL PC	Case	10,215
AMP52	MUCUS SPECIMEN SET I/WIRR	Case	39,247
A128BBAC	30ML UNI BORIC ACID3START	Case	8,280
A99999-15	SCREW CAP RUBBER LINER 16MM	Case	23,871
A99449-20	TUBE GLASS CULTUREDISEPOSABLE	Case	43,226
A100FLPLS	90ML CONT FLIP TOP BLUE	Case	11,935
A125CP	60MLCONTPLN LABELPC	Case	11,505
A128SC	30ML UNI CONT&SPOON STER LABEL	Case	16,559
A125BM	60MLCONTPTD LABELMC	Case	11,290
A99449-20X	TUBE GLASS CULTUREDISEPOSABLE	Case	46,022
A128B/P	30ML PP UNIVERSAL CONT PTD LAB	Case	7,634
A125CM	60MLCONTPLN LABELMC	Case	11,398

Cat No.	Description	Packing	Price Rs.
A128C/P	30ML PP UNI CONT PLAIN LABEL	Case	7,634
A128SB/50	30ML UNI CONT&SPOON BAGS 50	Case	18,817
A128SB	30ML UNI CONT&SPOONPTD LABEL	Case	17,957
A30932	ROUND BOTTOM TUBE 95*16MM PS	Case	5,376
A128SA	30ML UNI CONT&SPOON NO LABEL	Case	17,634
A2150N	MC TUBE 1.5ML WITH LID NEUTRAL	Case	42,581
A128BBAC/P	30ML UNI CONT PP PTD LAB BORIC	Case	7,957
A128SB/P	30ML PP UNI CONT PTD LAB L/S	Case	19,355
A185DB/IRR	100ML CONT PTD LAB D/BAG I/W	Case	52,366
A129AX/1	7ML TRAC BOTTLE NO LABEL& DISC	Case	41,935
A221S	SEMI MICRO CUUVETTE 3.0ML	Case	12,581
A39375T	5ML W.N SC NO LAB MT(TRAY) 420	Case	60,753
A185AM	100ML CONTAINER NO LABEL M/C	Case	16,452
A36100	TEST TUBE 110*16 CONICAL BASE	Case	16,774
A27391	75MMM GLASS CAPILLARY (BTS)	Case	6,452
AM00925	150ML CONT METAL CAP PLN LABEL	Case	8,172
AF190C	PERNASAL SWAB TWISTED WIRE	Case	18,710
A39180	10ML N.N GLASS B.C.TNO LABEL	Case	46,022
ABG50E	BENCH GUARD EXTRA ABSORBENT	Case	20,000
ABG50	BENCH GUARD ABSORBENT PAPER	Case	16,022
A451CST	SWAB VEGETAL COATED (100)	Case	2,796
A122	50MM PETRI DISH 1 VENT (SHALLO	Case	32,796
A165B	150ML CONT PTD LABEL	Case	12,903
A190C/IRR	250ML CONTAINER PLAIN LABEL IR	Case	6,022
A99449-16	TUBE GLASS CULTUREDISPOSABLE	Case	64,516
A100FLS	90ML CONT FLIP TOP CLEARPP	Case	13,441
A165C	150ML CONT PLN LABEL	Case	12,903
A128B/50	30ML UNI CONT BAGS 50	Case	11,935
A123	60MM PETRI DISH 1 VENT	Case	20,215
A144AS	13.5ML CONICAL THREAD TESTTUBE	Case	11,398
AF192C	PERNASAL SWAB - TWISTED WIRE	Case	18,602
A144C	CHLAMYDIA TRAN SWAB PLASTIC AP	Case	3,118
A147C	VIRAL TRANS SWAB PLASTIC APP	Case	3,118
A28464	350ML SCREWCAP JAR WAD PS	Case	29,247
ASPCS01	L SHAPE PLASTIC BLUE SPREADER	Case	18,065
A128C/FS	30ML UNI PLN LAB FLOW SEAL CAP	Case	13,441
A28480	350ML SCREWCAP JAR WADIRR	Case	30,645
AM00525	7ML BIJOU NOLABEL ASEPTIC	Case	10,645
AF160CA	SWAB PLAIN WIRE STICK	Case	4,301
A28308	30ML SCREWCAP JAR WAD PS	Case	22,796
AM00985	30ML UNIVERSAL CONT - NO LABEL	Case	14,086
AF168CA	SWAB PLAIN TWISTED WIRE STICK	Case	13,871
A28423	230ML SCREWCAP JAR WAD PS	Case	23,763
ASPCS05	L SHAPE PLASTIC BLUE SPREADER	Case	18,817
A18192CST	SWAB TRANS TWISTED STICK	Case	93,118
A18190CST	TRANS SWAB TWIST STICK	Case	93,118
A9998-13	DISPOSABLE SCREW CAP PTFE	Case	25,591
A109	100MM SQUARE DISH	Case	17,312
A18116CST	SWAB TRANSPORT AMIES CHC	Case	37,742
A18110CST	TRANS SWAB ALUMINIUM APP O/CAP	Case	37,742
AF150CA	SWAB PLAIN WOODEN STICK	Case	2,151
A99449-13	TUBE GLASS CULTUREDISPOSABLE	Case	60,645
A142AS	TEST TUBE 100*16 RB CAP WHITE	Case	11,505
A128BBAC/50	30ML UNI CONT B/A FLOW CAP RED	Case	14,839
A39164	10ML N.N GLASS B.C.T LABELLED	Case	51,398
A99445-13	TUBE GLASS CULTUREDISPOSABLE	Case	12,043
A18111CST	SWAB TRANS SYN TIP W CAP	Case	25,806
A18114CST	TRANS SWAB AMIES WTH CHAR ALPK	Case	25,806

Cat No.	Description	Packing	Price Rs.
A18108CST	TRANS SWAB AMIES W/O CHAR ALPK	Case	25,806
A128SB/1	30ML UNI CONT PTD LABEL T/PACK	Case	21,935
A28381	120ML SCREWCAP JAR WAD NOLABEL	Case	17,849
ASL1H	1UL HARD LOOPS DARK GREEN	Case	5,914
ASL1S	1UL SOFT LOOPS PALE GREEN	Case	5,914
ASL10H	10UL HARD LOOPS DARK BLUE	Case	5,914
ASL10S	10UL SOFT LOOPS PALE BLUE	Case	5,914
A128B/FS	30ML UNI PTD LAB FLOW SEAL CAP	Case	13,118
A142ASR	TEST TUBE 100*16 RB CAP RED	Case	14,194
ASN20	INOCULATION NEEDLES VIOLET	Case	7,419
A414CST	M40 AMIES,CHARCOAL SWAB	Case	30,215
A408CST	M40 AMIES TRANSPORT SWAB	Case	30,215
A165KS100	SWAB PLAIN WOOD STICK COT TIP	Case	19,892
ALXPB180L	180ML BLUE CONT/CAP PTD LAB PP	Case	16,344
A124	50MM PETRI DISH DEEP FORM	Case	19,032
A128A/IRR	30ML UNI NO LBL QUICKSTART IRR	400	8,925
A30924	ROUND BOTTOM TUBE 75*13MM PS	Case	8,280
A128A/FS	30ML UNI NO LAB FLOW SEAL CAP	Case	13,333
A483CE	FLOCK TRANS SWAB LIQ AMIES	Case	9,355
A484CE	PAED FLOCK TRAN SWAB LIQ AMIES	Case	9,355
A99445-20	TUBE GLASS CULTUREDISPOSABLE	Case	19,462
A493CE02	MSRA KIT 2REG SWABS	Case	10,860
A482CE	LIQ AMIES PERNASAL FLOCK SWAB	Case	8,817
A99999-13	SCREW CAP RUBBER LINER 13MM	Case	21,935
ART15	TEST TUBE 40 X 6MM R.BASE	Case	44,086
AWSC500	500ML WATER BOTTLE DOSED	Case	24,409
A505	COUNT INSERT VIAL&CAPPP	Case	22,796
A480CE	FLOCKED SWAB 1ML LIQ AMIES REG	Case	7,634
A490CE.A	1ML LIQ AMIES REG FLOCK SWAB	Case	7,634
A39404	GLASS UNIVERSAL CONTAINER	Case	29,677
A481CE	LIQ AMIES MINITIP FLOCK SWAB	Case	8,495
A511CS01	ENDOCERVICAL FLOCKED SWAB I/W	Case	5,161
A905C	SQUARE SAMPLING KIT	Case	4,301
A903C	SWAB RINSE KIT ALINGATE TIP	Case	6,237
A904C	SWAB RINSE KIT LARGE TIP SWAB	Case	5,376
A13CAP	TAPERED 13MM PUSH CAP	Case	7,204
A129B	7ML BIJOU LABELLED	Case	12,903
AWSC500/NT	500ML WATER BOTTLE NOT DOSED	Case	22,688
APF55	55MM PETRI DISH NON VENT ASEPT	Case	29,785
APF55V	55MM PETRI DISH VENTED ASEPT	Case	29,785
A516CS01	FLOCKED SWAB NEONATAL MINITIP	Case	7,957
A501CS01	MINITIP FLOCKED SWAB I/W	Case	7,957
A502CS01	REGULAR FLOCKED SWAB I/W	Case	7,957
A503CS01	NASOPHARYNGEAL MINITIP SWAB IW	Case	7,957
A350C	UNI TRANS MED BULK TUBES 1ML	Case	11,183
A085C	CAP FOR 16 X 100MM UTM TUBE	Case	18,710
AS23C	NS HOLDER FOR 509/510	Each	15,269
A346C	UTM 3ML MED REG FLOCKED SWAB	Case	17,312
A305C	UTM 3ML MED NASOPHARYNGEAL	Case	17,312
A519CS01	REGULAR FLOCKED SWAB B/P 100MM	Case	7,527
AS23E	NS HOLDER FOR 511	Each	18,710
A330C	UNI TRANS MEDIUM BLK TUBES 3ML	Case	13,333
A56380CS01	MID TURBINATE ADULT FLOCK SWAB	Case	16,882
A321C	UTM 3ML MED 2 FLOCKED SWAB	Case	22,903
A347C	UTM 3ML MED NEONATAL SWAB	Case	17,849
A328C	UTM COL KIT 3ML MED STD SWAB	Case	15,161
ABG60E	BENCH GUARD EXTRA ABSORBENT	Case	10,538
A570CS01	L SHAPED ENDOCERVICAL SWAB	Case	68,172

Cat No.	Description	Packing	Price Rs.
A800C	URISWAB SQUEEZE TUBE	Case	125,591
A608C	ENAT 1ML SOLUTION IN TUBE	Case	88,602
A612C	3ML CYMOL 16 X 100ML TUBE	Case	177,419
A608CS01R	1ML ENAT + REG FLOCKED SWAB	Case	178,710
A606C	TUBE WITH 2ML ENAT SOLN	Case	96,022
A613C	10ML CYMOL 25 X 90MM TUBE	Case	122,796
A366C	UTM 2ML MED, REG FLOCKED SWAB	Case	104,194
A525CS01	URETHRAL FLOCKED SWAB P/POUCH	Case	80,000
A49684	SODA GLASS RB TUBE 75X10	Case	9,462
A361C	UTM 1ML MED M/TIP FLOCKED SWAB	Case	15,269
A360C	UTM 1ML MED NASOPHARYNGEAL	Case	15,269
A359C	UTM 1ML MED REG FLOCKED SWAB	Case	15,269
AF152CA	SWAB CHARCOAL COATED	Case	3,118
A49635	SODA GLASS RB TUBE 75X12MM	Case	10,430
A185PYR	100ML CONTAINER NON-PYROGENIC	200	28,000
A902C	SWAB RINSE KIT STANDARD TIP	Case	3,011
A9998-18	SCREW CAP PTFE LINER AUTOCLAVA	Case	27,634
A128B/1	30ML UNI PTD LAB QSTART T/PACK	Case	13,226
A129BX/1	7ML B/B PTD LABEL, TRAC-DISC	Case	47,849
A128A/P	30ML PP UNIVERSAL CONT NO LAB	Case	7,742
A99445-16XX	TUBE GLASS CULTUREDISPOSABLE	Case	21,935
AP903S	90MM PETRI DISH 3V SHALLOW	Case	10,968
AM00915	150ML CONT METAL CAPNO LABEL	Case	8,602
A128A/1	30ML UNI NO LAB QSTART T/PACK	Case	13,978
AP903S/720	90MM 3V GBPO SINGLE LINER BAG	Case	13,226
AP903	90MM PETRI DISH 3 VENT PLAIN	Case	9,785
AP901	90MM PETRI DISH 1 VENT PLAIN	Case	9,570
A101R20/C	90MM PETRI DISH 1 VENT STANDAR	Case	9,892
A129BBAC	7ML BIJOU BOTTLE PTD LABEL B/A	Case	31,505
A202C	155MM PIP PASTGBP	Case	14,086
A39172	5ML N.N GLASS B.C.TNO LABEL	Case	92,043
ALXP60/P	60ML PP CONT, WHT CAP, NO LAB	Case	14,301
A75CTP1	75MM*12MM PP TUBE IND.WRAP	Case	28,280
AB28S MEDIC	CAP 28MM FLOW SEAL	Case	41,183
AI71061	P5B.C.T EMPTY NO LABELPP	Case	34,409
A131B/C50	Prmary Urine Tube, screw cap with colle	Case	19,032
A131B	Prmary Urine Tube, Screw Cap	Case	23,978
AQL1	1ULQUADLOOP WITH SPHERE	Case	8,925
AQL10	10UL QUADLOOP WITH SPHERE	Case	8,925
AM00850	60ML CONT PLASTIC CP PLN LABEL	Case	10,753
ALXP180/P	180ML PP CONT WHT CAP NO LAB	Case	14,301
ALXP125/P	125ML PPCONT WHT CAP NO LAB	Case	17,634
A520CS01	REGULAR FLOCKED SWAB I/W	Case	11,828
A516C	FLOCKED SWAB NEONATAL IN TUBE	Case	9,677
A551C	FLOCKED SWAB MINITIP IN TUBE	Case	9,677
A553C	FLOCKED SWAB PERNASAL IN TUBE	Case	9,677
A552C	FLOCKED SWAB REGULAR IN TUBE	Case	9,677
AWB30328	ANTI STATIC BLACK LARGE	500	11,398
A3520CA	FLOCKED SWAB 2ML PEEL POUCH	Case	41,720
A3520CF	FLOCKED SWAB 2ML EVA DUCT	Case	48,387
A101RT/C	90MM PETRI DISH 0 VENT	500	9,785
A101R20	90MM PETRI DISH 1 VENT	500	9,570
A101VR20/C	90MM PETRI DISH 3 VENT CLASSIC	Case	9,785
AMGP0050025P	PVC TUBE 0.5X0.25MMX15M COIL	CO	4,624
AMGP0050050P	PVC TUBE 0.5X0.5MMX15M COIL	CO	4,624
A90032-17	Petri Dish 90mm Shallow Triple Vent	600	14,946
AMGP0800160P	PVC TUBE 8.0X1.6MMX15M COIL	CO	16,237
ASR7SHT1111180	SR70 SHEET 11" X 11" X 1/8"	Each	14,086

Cat No.	Description	Packing	Price Rs.
AMGP0950160P	PVC TUBE 9.5X1.6MMX15M COIL	CO	20,000
ALXP40/P	40ML CLEAR CONT WHITE CAP PP	Case	21,075
AMGP0480080P	PVC TUBE 4.8X0.8MMX15M COIL	CO	7,957
A222M	MACRO CUVETTE PMMA 4.5ML	Case	15,806
A99445-16X	TUBE GLASS CULTUREDISPOSABLE	Case	20,323
A128DB/IRR	30ML PTD LAB D/BAG I/W IRR	Case	35,699
A493CE03	MRSA COLLECTION KIT 3 REG SWAB	Case	13,548
AS31	SCIN. BOTTLE&CAP	Case	22,688
A99445-16	TUBE GLASS CULTUREDISPOSABLE	Case	19,892
AWB30331	8ML WEIGH BOAT DIA WHITE A/ST	500	3,579
A190B/1	250ML CONTAINER PTD LABEL SW	Case	7,527
A165KS01	SWAB PLAIN WOODEN STICK I/W	Case	16,452
AWB30335	ANTI STATIC BLACK MEDIUM WB	500	5,895
A185CP	100ML CONTAINER PLN LABEL PC	Case	16,452
A185BP	100ML CONTAINER PTD LABEL PC	Case	16,452
ABG60/100	BENCHGUARD 0.60X.049 SHT PK100	Case	14,301
AWB30334	30ML WEIGH BOAT WHITE A/STAT	500	4,842
AWB30304	LARGE WEIGH BOAT 140X140	500	10,753
A190A/1	250ML CONTAINER NO LABS/WRAP	Case	7,527
AWB30332	ANTI STATIC BLACK ULTRA	500	4,000
A185AP	100ML CONTAINER NO LABELPC	Case	16,452
AWB30305	BLACK LARGE WEIGH BOAT	500	11,075
A511HT	DISPOSAL BAG 610X810MM HT	200	17,097
A470CE.A	FAECAL SWAB	Case	13,978
A99445-12	TUBE GLASS CULTURE DISPOSABLE	Case	10,000
A3520CS01	FLOCKED SWAB PEEL POUCH	Case	35,376
AF155CA	SWAB PLAIN PLASTIC STICK (100)	100	2,000
A922C	RINSE KIT SWAB I/W TIPPED	Case	11,720
A926C	RINSE KIT SWAB B/P TIPPED	Case	10,860
A99445-15	TUBE GLASS CULTUREDISPOSABLE	Case	19,677
AWSC1000/NT	1000ML WATER BOTTLE NOT DOSED	Case	22,796
AWB30324	ANTI-STATIC REGULAR WEIGH BOAT	500	6,000
A101/IRR	90MM PETRI DISH 1 VENT IRRAD	500	14,731
AWSC500T	500ML TOMBSTONE WATER BOTTLE	Case	37,097
A510LHT	DISPOSAL BAG 406X610MM HT	500	25,054
A99445-10	TUBE GLASS CULTUREDISPOSABLE	Case	8,925
A190B	250ML CONTAINER PRINTED LABEL	Case	6,667
AWSC500T-20	500ML RECT BOTTLE DOSED 20MG	Case	37,849
A509LHT	DISPOSAL BAG 406X610MM HT	200	10,215
AWSC1000	1000ML WATER BOTTLEDOSD	Case	25,376
A185CM	100ML CONTAINER PLN LABEL MC	Case	16,452
A510HT	DISPOSAL BAG 307X660MM(HT)	500	21,613
A185BM	100ML CONTAINER PTD LABEL MC	Case	16,774
AWSC500T/NT	500ML TOMBSTONE WATER BOT N/D	Case	36,129
A103	100MM SQ.DISH 25 COMPARTMENTS	1000	25,914
AWSC1000-20	1000ML WATER BOTDOSD 20MG	Case	25,914
A30908	ROUND BOTTOM TUBE 64*11MM PS	Case	12,366
AWB30255	BLACK REGULAR WEIGH BOAT	500	6,129
A193B	250ML CONT PTD LABEL (190B) PP	Case	10,430
AWB30317	LARGE DIAMOND WEIGH BOAT	500	10,323
AWB30318	BLACK LARGE DIAMOND WEIGH BOAT	500	11,075
A101VR20	90MM PETRI DISH 3 VENT	500	4,839
AS23B	NS HOLDER FOR 511 (PACKS/10)	10	15,806
A101VRED	90MM PETRI DISH 3 VENT RED	400	14,086
AWB30315	BLACK MEDIUM DIAMOND WEIGHBOAT	500	5,376
AWB30321	ANTI STATIC MICRO WEIGH BOAT	500	3,684
A190AIW	250ML CONTAINER NO LABI/WRAP	Case	11,505
AWB30205	MICRO WEIGH BOAT 44X44MM	500	3,763

Cat No.	Description	Packing	Price Rs.
AWB30312	BLACK ULTRA SMALL DIAMOND	500	3,656
AWB30327	ANTI STATIC LARGE WEIGH BOAT	500	10,632
A504	55MM CONTACT PLATE	1000	21,183
A101VBLUE	90MM PETRI DISH 3 VENT BLUE	400	14,086
A101VAMB	90MM PETRI DISH 3 VENT AMBER	Case	14,086
A7077-5X	0.5ML SEROLOGICAL PIPETTE I/W	Case	23,548
AWSC350/NT	350ML WATER BOTTLEUNDOSED	Case	39,785
AWB30314	MEDIUM DIAMOND WEIGH BOAT	500	4,194
AWSC350	350ML WATER BOTTLEDOSED	Case	46,344
A509	DISPOSAL BAG 305X660MM	200	4,421
A502VF	90MM PETRI DISH 2 COMP FROSTED	500	14,731
AWSC350-20	350ML WATER BOTTLEDOSED 20mg	Case	47,419
A510L	DISPOSAL BAG 406X610MM	500	19,570
A510	DISPOSAL BAG 305X660MM	200	13,871
AWB30311	5ML WEIGH BOAT DIAMOND	500	3,441
A509L	DISPOSAL BAG 406X610MM	200	8,065
AWB30338	ANTI STATIC BLACK LARGE W B	500	12,688
AM00293	10ML THREADED TUBE LUCKHAMS PS	Case	8,602
A190A/IRR	250ML CONTAINER NO LABEL IRRAD	Case	11,935
AWB30337	100ML WEIGH BOAT DIA A/STAT	500	9,579
AWB30206	BLACK MICRO WEIGH BOAT	500	4,086
A3355	Clear Flat-Bottom Immuno Nonsterile 96-Well Plates	50	5,054
A128B	30ML UNI CONT PTD LABEL QUKSTR	400	7,684
A128PYR	30ML UNI NON-PYROGENIC QUICKST	400	28,105
ASR7SHT0707180	SR70 SHEET 7" X 7" X 1/8"	Each	4,839
AWB30325	ANTI STAT BLACK REG WEIGHBOAT	500	11,183
A128A	30ML UNI CONT NO LBL QUICKSTAR	400	7,684
A190C	250ML CONTAINER PLAIN LABEL	Case	6,526
A222S	SEMI MICRO CUVETTE PMMA 3.0ML	500	13,226
A192BLUE	250ML DIPPA & HANDLE(BLUE)	50	23,053
AWB30254	REGULAR WEIGH BOAT 80X80	500	5,789
AWB30322	ANTI STATIC BLACK MICRO	500	4,316
A101VIRR	90MM PETRI DISH 3 VENT IRRAD	500	6,452
ATSR0150050P	Tsr Tube 1.50x0.50mmx15m Coil	Meter	7,419
ATSR0100050P	Tsr Tube 1.00x0.50mmx15m Coil	Meter	7,312
A718	GRADUATED TRANSFER PIPET NS	500	9,334
A3752-RI	HLT 200L SOFTFIT L 200UL CLR	960	35,903
A580-GRDS-Q	5ML TUBE AND ATTACHED CAP STER	20	8,886
A580-GRD-Q	Thermo Scientific™ QSP™ Transport Tube	1000	4,917
A212	Samco 3.9mL Graduated Transfer Pipets, Small Bulb , Graduated To 1mL, Non-sterile	5000	8,696
A3752-HR	HLT 200L SOFTFIT L CLR	960	36,142
A3752	200ul Pipet tip, SoftFit-L, Reinforced Tray, fit Rainin LTS Pipettors	960	38,929
A222	Samco 5.8mL Graduated Transfer Pipets, Large Bulb, Non-sterile, Graduated To 1mL	5000	9,366
A225-1S	Samco 7.5mL Graduated Transfer Pipets, L	4000	27,457
A581-GRDS-Q	10ML TUBE AND ATTACHED CAP STE	20	8,607
A225	Samco 7.5mL Graduated Transfer Pipets, Large Bulb, Non-sterile, Graduated 0.50 To 3mL	5000	10,964
A225NL	Samco 7.5mL Graduated Transfer Pipets, Large Bulb, Non-sterile, Graduated 0.50 To 3mL, White Box	5000	10,964
A262-1S	Samco 6.0mL Extra Long Transfer Pipets, 9", Sterile, Individually Packed	3200	42,258
A262	Samco 6mL Extra Long Transfer Pipettes NS	4000	11,505
A3457IW	HLT 3457 IW TUBE LK 1.5 ML MCT	500	18,103
A9420320	Finnpipette™ Stands	Each	3,713
A3457IWMBP	HLT 3457 IW TUBE LK 1.5 ML MCT	500	18,103
A225-20S	Samco 7.5mL Graduated Transfer Pipets, L	4000	14,516
A9501	Matrix Serological Pipet Filler, White	Each	29,773

Cat No.	Description	Packing	Price Rs.
A9521	Matrix Serological Pipet Filler, Blue	Each	29,773
A9511	Matrix Serological Pipet Filler, Clear	Each	29,764
A9531	Matrix Serological Pipet Filler, Red	Each	29,773
A9541	Matrix Serological Pipet Filler, Green	Each	29,773
A2279	ART 1000 SOFTFIT RACKED ST	3200	23500
A2069-05	ART 200 LR RACKED ST	960	10,205
A2139JP	ART 10 MICROPOINT RACKED ST	5 X 960 TIPS	30300
A2079JP	ART 1000 REACH RACKED ST	3200	11,556
A2139-05	ART 10 LR MICRO TIP RACKED ST	960	10,241
A3471R	Screw cap with O ring- Red	5000	33,459
A2069JP	ART 200 MICROPOINT RACKED ST	5 X 960 TIPS	29900
AIN-2149P	ART 20P MICROPOINT DESIGN ST	960	6,354
A3771-05-HR	300 UL, Racked, sterile, Low retention	960	5,723
A2079-HR	ART 1000 REACH HINGED RACKED ST	3072	7,565
A2149P-05	ART 20P LR RACKED ST	960	10,182
A2069-05-HR	ART 200 lr HINGED RACK ST	960	11,313
A2140-05	ART 10 REACH LR RACKED ST	960	10,887
A2079EIW	ART 1000E IND.WRP ST	500 Tips per pack	9,577
A2065E-05	ART 100E Low retention	960	10,879
A2065JP	ART 100 RACKED MICROPOINT ST	5 X 960 TIPS	30100
A2070JP	ART 300 MICROPOINT RACKED ST	960	7,698
A2139-05-RT	ART 10LR Reload Tower	960	7,842
A2069-RT	ART 200 Reload Tower	960	4,877
A2149JP	ART 20UL PIPET TIP RACKED ST	5 X 960 TIPS	29800
A3470	HLT 2.0ML CONICAL MCT W/O CAP	5000	1,848
A2139-HR	ART 10 HINGED RACK ST	960	6,358
A2069-HR	ART 200 HINGED RACK ST	960	6,322
A3461MBP	1.5 ML CONICAL MCT W/SCW CAP &	5000	5,646
A7010JP	250mL Bottle	Each	2,348
A7003	1 L bottle	Each	5,555
A2279-05	ART 1000 LR RACKED ST	800	10,010
A2149P-HR	ART 20P HINGED RACK ST	960	6,349
A2140-05-HR	ART REACH LR HINGED RACK ST	960	10,874
A2149P-RT	ART20P Reload Tower	960	4,906
A2069B	ART 200 BULK NST MICROPOINT	1000	4,175
A2139B	ART 10 MICROPOINT BULK NST	1000	4,197
A3690MBP	200ul Round Gel Loading Pipet Tip, .61mm OD	1000	2,116
A7002JP	475 mL spray bottle	Each	3,850
A3471G	Screw Cap with O ring - Green	5000	2,095
A3454JP	HLT 3454 TUBE LK 0.6 ML MCT	10000	1,711
A2279B	ART 1000 SOFTFIT BULK NST	1000	4,111
A3551-HR	HLT 250 ul Thinwall, racked, Sterile	960	4,947
A3471B	Screw cap with O ring- Blue	5000	2,088
A3451	HLT 3451 TUBE 1.5 ML MCT	5000	1,421
A3501-HR	10 ul, pure tips, racked sterile	960	5,076
A2780	ART 50U SOFTFIT MLTICHANEL ST	960	6,101
A2065-RI	ART 100 RELOAD INSERTS ST	960	5,221
A3101-05-HR	Hinged Racked, Sterile,1000ul pipette tips, Low retention	3072	4,973
A2149PB	ART 20P MICROPOINT BULK NST	1000	4,184
A3471V	Screw Cap with O ring (Violet color)	500	3,134
A3471O	HLT THREADED SCW CAP W/O RING	5000	2,141
A2065-HR	ART 100 HINGED RACK ST	960	6,335
A3500-05-11	10 ul, low 10 ul, low retention	10	2,104

Cat No.	Description	Packing	Price Rs.
A2160P-HR	ART 200 XLP Racked	3840	10,518
A3434	HLT 3434 TUBE 2.0 ML MCT	5000	1,435
A3772-HR	300 ul, Racked, non sterile	960	4,501
A3467MBP	HLT 3467 1.5ML FRE-STND MCT W/	5000	5,723
A3453	HLT 3453 TUBE 2.0ML MCT	5000	1,465
A5479E	ART SOLVENTSAFE 1000E RCKED ST	3200	8,630
A2279IW	ART 1000 SOFTFIT IND.WRP ST	500	10,391
A3501-05-HR	10 ul, pure tips, racked sterile, Low retention	960	6,442
A2080-HR	ART 1250XL HR	3072	8,345
A2079E	ART 1000E RACKED ST	800	9,723
A3449	HLT 3449 0.6 MCT GRADUATED	1000	1,716
A2079G	ART 1000G GENOMIC RACKED ST	3200	9,696
A3468	HLT 2.0ML CONICAL MCT W/SCW CP	5000	3,538
A2065EB	ART 100E MICROPOINT BULK NST	1000	9,263
A3472	0.5ML FREE STAND MCT W/CRW CAP	5000	3,591
A2160P	ART XLP 200UL EX.L RACKED ST	768	10,575
A3465	HLT .5ML FREE STANDING MC TUBE	5000	5,449
A7005JP	4 L bottles	Each	11,528
A3457MBP	HLT 3457 TUBE LK 1.5ML MCT	5000	1,547
A3463MBP	HLT 2.0ML CONICAL MC TUBE	5000	5,511
A8820JP	Cryogenic Rack	Each	1,182
A7000JP	250 mL bottle	Each	2,728
A3459MBP	HLT 3459 TUBE LK 2.0 ML MCT	5000	3,026
A2080JP	ART 1250 EXT. LENGTH RACKED ST	768	10,826
A2140-HR	ART 10 REACH HINGED RACK ST	960	10,099
A3792-HR	HLT 1000 REACH XL HR RK	3072	3,810
A3487	1.2ML MICROTITER TUBE	4800	3,577
A3472A	0.5ML FREE STAND MCT W/SCW CAP	5000	4,328
A3550JP	HLT 250 THINWALL CLR BULK NST	1000	2,553
A3474JP	1.5ML FR-STAND MCT W/CRW CAP &	5000	3,760
A2139-RT	ART Reload Tower sterile	960	4,932
A3551-05-HR	HLT 250 ul Thinwall, racked, Sterile,Low retention	960	4,773
A2069G	ART 200G GENOMIC RACKED ST	960	10,102
A2065E	ART 100E RACKED MICROPOINT ST	960	10,216
A3550-05	200ul Pipet Tip - Thin Wall, Clear, MicroPoint Design, Low Retention	1000	2,260
A2069IW	ART 200 IND.WRP. MICROPOINT ST	500	9,514
A3500JP	HLT 10 MICROPOINT BULK NST	1000	1,834
A2149P-05-HR	ART 20P LR HINGED RACK ST	960	9,036
A3551	HLT 250 THINWALL CLR RKD ST	960	5,453
A2079-05-HR	ART 1000 REACH HINGED RACKED ST LR	3072	10,370
A3591JP	HLT 1000G GENOMIC RK ST	800	4,792
A5520	ELECTROPORATION CUVETTE, 2mm	250	20,988
A2139-05-HR	ART 10 LR HINGED RACK ST	960	11,382
A2155P	ART GEL 20P RACKED ST	960	12,327
A3101-HR	Hinged Racked, Sterile,1000ul pipette tips	768	4,991
A2179-05-RT	ART 1000XL RELOAD TOWER, LR	2800	7,546
A3459IWMBP	HLT 3459 IW TUBE LK 2.0 ML	500	5,385
A2149E-HR	ART 20E HINGED RACK ST	960	9,398
A2149E	ART20E 10UL ULTRAMICRO RCKD ST	960	8,577
A3791-HR	HLT 1000 REACH XL HR RKS	3072	4,290
		200	6,812
AIN3631	HLT FLAT GEL 200 RK NST	TIPS/TRAY, 1 TRAY PER PACK	
A3464	HLT 1.5 CONCL MC TUBE W/SC CAP	5000	3,250
A2149P-RI	ART 20P, 20ul pipet tip w/ART barrier, R	4800	8,278
A3502-05-HR	Hinged Racked, Non-Sterile,10ul pipette tips, Low retention	960	5,552
A5510-11	ELECTROPORATION CUVETTE, 1mm	50	22,183

Cat No.	Description	Packing	Price Rs.
A8670	Reversible Microtube Rack	Each	1,478
A5469	ART SOLVENT SAFE 200 RACKED ST	3840	7,235
A3496	HLT 1.2ML MICO TITER TUBE robotic rack, non sterile	4800	3,805
A2069-05-RT	ART 200 LR Reload Tower	960	10,782
A3590JP	HLT 1000G GENOMIC BULK NST	1000	2,302
A3460AMBP	HLT 3460A TUBE 0.5ML SC-MCT &	5000	4,576
A3464AMBP	HLT 1.5 CONCL MC TUBE W/SCW CP	5000	4,555
A3542-HR	HLT 200 REACH XL HR RK	3840	5,560
A8790	Flipper Rack	Each	2,071
A8860	4-Way Flipper Rack	Each	1,516
A3471Y	Screw cap with O ring- Yellow	5000	2,853
A3471A	Screw cap with O ring- Amber	5000	2,858
A3465A	0.5 FREE STAND MCT W/SCW CAP &	5000	7,256
A3456	HLT 3456 TUBE LK 1.5ML	5000	1,475
A2149P-05-RT	ART 20P LR Reload Tower	960	8,281
A3460	HLT 3460 TUBE 0.5ML SC-MCT &	5000	3,814
A2080-05-HR	ART 1250XL HR LR	3072	10,794
A2180B	ART 5000 5ML TIP BULK ST	250	6,548
A8640	Reversible Microtube Rack	Each	1,474
A8850JP	4-Way Flipper Rack	Each	1,581
A2179-HR	ART 1000XL HINGED RACK ST	768	11,705
A2140-05-RI	ART10 REACHLR RELOAD INSERT ST	960	11,902
A2139F-05	ART 10F LR RACKED ST	960	10,911
A2160P-05-HR	ART 200 Reach LR	768	10,858
A2065E-05-HR	ART 100E LR HINGED RACK	960	11,299
A7005	4 L bottles	Each	11,286
A2160G	ART XLG 200UL EXT.L GNOMC R ST	768	10,578
A3592JP	HLT 1000G GENOMIC RK NST	800	3,815
A3465MBP	HLT .5ML FREE STANDING MC TUBE	5000	5,567
A3488A	HLT 2.0ML FR-STAND GRAD MCT W/	5000	4,539
A8660	Reversible Microtube Rack	Each	1,479
A8658JP	Flipstrip Rack	Each	1,548
A8680JP	Reversible Microtube Rack	Each	1,550
A3772-05-B	300 ul, Bulk, Non sterile, Low retention	1000	2,134
AIN8800	Cryogenic Rack	Each	1,197
A3541-HR	HLT 200 REACH XL HR RKS	3840	6,949
A3471	HLT THREADED SCW CAP W/O RING	5000	2,096
A3461A	HLT 3461A 1.5ML CNICL MC TUBE	5000	6,967
AIN8810	Cryogenic Rack	Each	1,168
A3151-HR	HLT 1250 REACH XL HR RKS	3072	6,533
A8780	Flipper Rack	Each	1,990
A8760	Flipper Rack	Each	1,990
A3448	HLT 3448 TUBE 1.5ML MCT	5000	1,369
A8830JP	Cryogenic Rack	Each	1,168
A2140B	ART 10 REACH BULK NST	5000	5,105
A8810	Cryogenic Rack	Each	1,143
A3521-05-HR	Ultra micro, 20 ul, sterile, Hinge racked, Low retention	960	5,707
A3791-05-HR	HLT 1000 REACH XL LR HR RK	3072	4,921
A3446	HLT 3446 0.6 MCT GRADUATED	1000	1,722
A3431MBP	HLT 3431 TUBE 0.5ML SC-MCT &	5000	4,982
A3521-RT	Ultra micro, 20 ul, sterile, Reload Tower	960	4,704
A8650	Reversible Microtube Rack	Each	1,479
A8668	Flipstrip Rack	Each	1,483
A8690JP	Reversible Microtube Rack	Each	1,546
A3483	HLT .25ML POLYPROPYLENE TUBE &	5000	2,298
A8770-11	Flipper Rack	Each	2,076
A3468AMBP	2.0ML CONICAL MCT W/SCW CP & O	5000	4,487
A8628JP	Flipstrip Rack	Each	1,552

Cat No.	Description	Packing	Price Rs.
A3457	HLT 3457 TUBE LK 1.5ML MCT	5000	1,515
A8800	Cryogenic Rack	Each	1,171
A8770JP	Flipper Rack	Each	2,076
A8688	Flipstrip Rack	Each	1,517
A8678	Flipstrip Rack	Each	1,482
A3466JP	1.5 ML CONICAL MC TUBE, CLEAR	5000	1,678
A8638JP	Flipstrip Rack	Each	1,530
A3771-HR	300 UL, Racked, sterile	960	5,518
A3521-HR	Ultra micro, 20 ul, sterile, Hinge racked	960	5,154
A2139	ART 10 MICROPOINT RACKED ST	960	6,062
A2069	ART 200 MICROPOINT RACKED ST	960	5,980
A5510	ELECTROPORATION CUVETTE, 1mm	50	22,183
A5540	ELECTROPORATION CUVETTE, 4 MM	50	23,268
A2079	ART 1000 REACH RACKED ST	3200	11,313
A2149P	ART 20P MICROPOINT DESIGN ST	960	6,221
A7002	475 mL spray bottle	Each	3,769
A2149	ART 20UL PIPET TIP RACKED ST	960	5,969
A2070	ART 300 MICROPOINT RACKED ST	960	7,536
A2065	ART 100 RACKED MICROPOINT ST	960	6,020
A3454	HLT 3454 TUBE LK 0.6 ML MCT	10000	1,675
A7000	250 mL bottle	Each	2,671
A3461	1.5 ML CONICAL MCT W/SCW CAP &	5000	5,527
A3690	200ul Round Gel Loading Pipet Tip, .61mm OD	1000	2,072
A3474	1.5ML FR-STAND MCT W/CRW CAP &	5000	3,681
A3550	HLT 250 THINWALL CLR BULK NST	1000	2,499
A2080	ART 1250 EXT. LENGTH RACKED ST	768	10,598
A8850	4-Way Flipper Rack	Each	1,548
A3500	HLT 10 MICROPOINT BULK NST	1000	1,795
A3592	HLT 1000G GENOMIC RK NST	800	3,735
A8820	Cryogenic Rack	Each	1,157
A8680	Reversible Microtube Rack	Each	1,517
A3467	HLT 3467 1.5ML FRE-STND MCT W/	5000	5,603
A3488	HLT FR-STAND GRAD MCT W/SCW CP	5000	3,605
A3459	HLT 3459 TUBE LK 2.0 ML MCT	5000	2,963
A3463	HLT 2.0ML CONICAL MC TUBE	5000	5,395
A3591	HLT 1000G GENOMIC RK ST	800	4,691
A3590	HLT 1000G GENOMIC BULK NST	1000	2,253
A3458	HLT 3458 TUBE LK 2.0 MLMCT	5000	1,630
A2179-05-HR	ART 1000XL LR HINGED RACK	3072	9,775
A3459IW	HLT 3459 IW TUBE LK 2.0 ML	500	5,271
A3621	HLT ROUND GEL 200 RK NST	200 TIPS/TRAY, 1 TRAY PER PACK	3,610
A3631	HLT FLAT GEL 200 RK NST	200 TIPS/TRAY, 1 TRAY PER PACK	6,962
A3464A	HLT 1.5 CONCL MC TUBE W/SCW CP	5000	4,459
A3460A	HLT 3460A TUBE 0.5ML SC-MCT &	5000	4,480
A8638	Flipstrip Rack	Each	1,498
A3466	1.5 ML CONICAL MC TUBE, CLEAR	5000	1,643
A3468A	2.0ML CONICAL MCT W/SCW CP & O	5000	4,393
A2790	175ul Pipet Tip, ART Poly Clear, Beckman Style (fits Multimek Type II, Tecan Genmate)	960	6,674
A2159PIW	ART XLP	500	6,354
A2160PIW	XLP 200, EXT. Length	500	9,719
A3467A	1.5 ML FR-STAND MCT W/SCW CAP	5000	8,377

Cat No.	Description	Packing	Price Rs.
A3102-05-RT	Reload Tower, Non Sterile, 1000µl pipette tips, Low retention	960	4,108
A3772-RT	300 ul, Reload Towers, non sterile	960	4,634
A3772-05-RT	300 ul, Reload Towers, non sterile, Non sterile	960	4,947
A3772-B	300 ul, Bulk, Non sterile	1000	2,004
A3152-05-HR	HLT 1250 REACH XL LR HR RK	3072	6,028
A2149E-RI	ART 20E RELOAD INSERTS ST	960	8,944
A3469A	HLT 2.0ML FR-STND GRAD MCT W/	5000	8,413
A3455-11	HLT 3455 TUBE LK 0.6ML MCT	1000	3,209
A2065E-05-RI	ART 100E LR RELOAD INSERTS ST	960	11,535
A3552-HR	HLT 250 ul Thinwall, racked, Sterile	960	4,342
A3474A	1.5ML FR-STND MCT W/SCR CAP &	5000	4,674
A3512-05	HLT 10 REACH LR RK NST	960	6,534
A2179-05-RI	ART 1000XL LR RELOAD INSERT ST	3072	7,448
A3485	HLT 0.4ML POLYETHYLENE TUBE &	5000	2,246
A3771-05-RT	300 ul, Reload tower, Sterile, low retention	960	5,592
A2079EB	ART 1000E BULK NST	1000	10,665
A3571	HLT TITERTEK 300 GRD RACKED ST	960	5,078
A3771-RT	300 ul, reload Tower	960	4,755
A2149E-05-RI	ART 20E LR RELOADS INSERTS ST	960	6,805
A3721-05-HR	ART 20L, SOFTFIT CLEAR, Low retention, sterile	960	8,239
A3722-05-HR	ART 20L, soffit clear, Low retention, non sterile	960	8,092
A2179-RI	ART 1000XL RELOAD INSERT	3072	10,979
A3478	HLT 1.5ML FR-STAND MCT W/O CAP	5000	2,202
A3521-05-RT	Ultra micro, 20 ul, sterile, reload Tower, Low retention	960	5,598
A3511	HLT 10 REACH 2UL REF RACKED ST	960	7,295
A3511-05	HLT 10 REACH LR RK ST	960	7,478
A3512-HR	HLT 10 REACH XL HR RK	960	6,047
A3581-05	HLT 1000 SOFTFIT RACKED LR ST	768	5,332
A3721	20 ul, pure tips sterile	960	7,495
A3581	HLT 1000 SOFTFIT RACKED ST	800	5,288
A3502-RT	Reload Tower, Non-Sterile, 10µl pipette tips	960	4,853
A3431-11	HLT 3431 TUBE 0.5ML SC-MCT &	5000	4,982
A3511-05-HR	HLT 10 REACH XL LR HR RKS	960	7,260
A2149PIW	ART 20P IND.WRP MICROPOINT ST	500 Tips per pack	9,799
ATTW110RN-Q	200UL TW CLR NS	960	4,143
A2140	ART 10 REACH RACKED ST	960	11,149
A2065E-RI	ART 100E RELOAD INSERTS ST	960	10,990
A2079GIW	ART 1000G IND.WRP ST	500	10,885
A085-Q	PIPETTE TIP 2500UL NATURAL BAG	Case	1,803
A3502	HLT 10 MICROPOINT RACKED NST	960	5,693
A3552-05-RT	HLT 250 ul Thinwall, reload tower, Sterile, Low retention	960	3,774
A8658-11	Flipstrip Rack	Each	1,548
A3511-HR	HLT 10 REACH XLHR RKS	960	6,747
A3422-11	0.5 HLT FREE STAND MCT W/O CAP	5000	1,811
A3469-11	HLT 2.0M. FR-STND GRAD MCT W/	5000	5,730
A3521	HLT ULTRA MICRO 20UL RCKED ST	960	6,635
A2770	ART 200U SOFTFIT MLTICHANEL ST	960	10,370
A2070-RT	ART 300 Reload Tower	960	6,610
A2070-05-RT	ART 300 LR RELOAD Tower	960	8,506
A3552-05-HR	HLT 250 ul Thinwall, racked, Sterile, Low retention	960	4,244
A3551-05	HLT 250 ul Thinwall, racked, Sterile, Low retention	960	4,962
A2149E-05-HR	ART 20E LR HINGED RACK ST	960	5,607
A3501-05-RT	10 ul, pure tips, reload tower, sterile, Low retention	960	6,070
A3512	HLT 10 REACH 2UL REF RCKED NST	960	6,325
A111-Q	PIPETTE TIP 101-1000UL BLUE BA	10000	2,076
A2139-RI	ART 10 RELOAD INSERTS ST	960	5,204
A8830-11	Cryogenic Rack	Each	1,168

Cat No.	Description	Packing	Price Rs.
A3522-05-HR	Ultra Micro 20 ul Racked Non Sterile, Low retention	960	5,983
A3522-05-RT	Ultra Micro 20 ul Reload Tower Non Sterile, Low retention	960	5,451
A2140-RI	ART 10 REACH RELOAD INSERTS ST	960	10,822
A3781	1000 ul, pure tips sterile	768	6,892
A3522-RT	Ultra Micro 20 ul Reload Tower Non Sterile	960	4,514
ATW110-N-Q	THIN WALL PIPETTE TIP 1-200UL	10000	1,322
A3896	5 ml HLT Tips	250	2,151
A8870	4-Way Flipper Rack	Each	1,581
A3771-05	PURE 300U	960	6,488
A3501-RT	10 ul, Reload Tower, sterile	960	4,732
A3570	HLT TITERTEK 300 GRD BULK NST	1000	2,035
A3152-HR	HLT 1250 REACH XL HR RK	3072	6,815
A2079GB	ART 1000G GENOMIC BULK NST	1000	9,745
A3426-11	HLT 3426 1.2 MICRO TITERTUBE	600	1,252
A3431A	HLT 3431A TUBE 0.5ML SC-MLT &	5000	5,587
A2139F	ART 10F MICROPOINT RACKED ST	960	8,154
A3772-05-HR	300 ul, Racked, non sterile, Low retention	960	5,156
A3541-05-HR	HLT 200 REACH XL LR HR RKS	3840	7,796
A3732-HR	300ul Pipet tip, SoftFit-L, Reinforced Tray, fit Rainin LTS Pipettors	4800	7,465
A3561	PURE 300E	960	6,389
A3572	HLT TITERTEK 300 GRD RCKED NST	960	4,526
A3531	HLT 200G GENOMIC RK ST	960	4,772
A2065E-HR	ART 100E HINGED RACK ST	960	11,771
A8698	Flipstrip Rack	Each	1,549
A3522	HLT ULTRA MICRO 20UL RCKED NST	960	5,664
A3582	HLT 1000 SOFTFIT RACKED NST	800	4,834
A3512-05-HR	HLT 10 REACH XL LR HR RK	960	6,470
A3462	HLT 3462 TUBE 0.5ML SC-MCT	5000	2,226
A2159P	ART XLP 100UL EX.LTH RACKED ST	768	10,798
A3102-HR	Hinged Racked, Non Sterile, 1000µl pipette tips	3072	3,820
A2155	ART GEL 100 RACKED ST	960	13,478
A3102-RT	Reload Tower, Non Sterile, 1000µl pipette tips	560	3,910
A2070B	ART 300 MICROPOINT BULK	1000	6,993
A3490	HLT 2.0ML FR-STND GRAD MCT W/O	5000	2,387
A3425-11	HLT 3425 1.2 MICRO TITERTUBE	600	1,439
A010-Q	PIPETTE TIP 1-200UL NATURAL BA	Case	1,949
A3792-05-HR	HLT 1000 REACH XL LR HR RK	3072	4,318
A3492	HLT 3492 1.2ML MICRO TITERTUBE	1000	4,189
A3502-05-RT	reload Tower, Non-Sterile, 10µl pipette tips, Low retention	960	5,478
A3552-RT	HLT 250 ul Thinwall, reload tower, Sterile	960	4,011
A3562	MBP 300E	960	5,915
A3542-05-HR	HLT 200 REACH XL LR HR RK	3840	5,907
A3151-05-HR	HLT 1250 REACH XL LR HR RKS	3072	6,942
A2149EB	ART 20E ULTRAMICRO BULK NST	1000	4,281
A3551-05-RT	HLT 250 ul Thinwall, reload tower, Sterile, Low retention	960	4,590
A3552	HLT 250 ul Thinwall, racked, Non sterile	960	4,504
A3101-05-RT	Reload Tower, Sterile, 1000µl pipette tips, Low retention	2800	5,093
A2070-05-HR	ART 300 LR Hinged Rack	960	9,373
A3751	200 ul, pure tips sterile	960	7,597
A3463A	HLT 2.0 ML CONICAL MC TUBE W/	5000	7,201
A2070-HR	ART 300 Hinge Rack	960	7,150
A3502-HR	Hinged Racked, Non-Sterile, 10µl pipette tips	960	5,601
A2179-RT	ART 1000XL RELOAD TOWER	2800	11,106
A089-Q	PIPETTE TIP 500-2500UL NATURAL	Case	2,112
A090-Q	PIPETTE TIP 1000-5000UL NATURA	Case	1,852
A3522-HR	Ultra Micro 20 ul Racked Non Sterile	960	5,516
A8690-11	Reversible Microtube Rack	Each	1,546
A3101-RT	Reload Tower, Sterile, 1000µl pipette tips	2800	4,869

Cat No.	Description	Packing	Price Rs.
A3551-RT	HLT 250 ul Thinwall, reload tower, Sterile	960	4,590
A2080B	ART 1250 EXT. LENGTH BULK NST	1000	9,683
A3771	HLT 300U SOFTFIT RACKED ST	960	5,595
A3102-05-HR	Hinged Racked, Non Sterile, 1000µl pipette tips, Low retention	3072	4,204
A8648	Flipstrip Rack	Each	1,541
A946-261	10ul Pipet Tip ,Poly (Clear)	3840	17,055
A947-261	30ul Pipet Tip,Poly (Clear)	3840	17,055
AAB3738	Easy Pierce Foil, Roll, 78mmx610mm	Each	140,968
A566-0020	FLTR,A-PES,500ML,75MM,0.2]]	12	11,263
A567-0020C	FLTR,A-PES,1L,90MM,0.2]]	12	15,474
A568-0020	FLTR,A-PES,250ML,50 MM,0.2]]	12	6,947
A725-2520	Nalgene syringe filter, .22 micron, PES, 25mm diameter	50	6,947
A597-4520	BTLTOP,A-PES,45MM,1L,90MM]]	12	12,000
A5000-0020	CRYOGENIC VIAL 2.0ML]], PPCO	500	17,158
A165-0045	FLTPES,45MM,150ML,50MM;0.45U==	12	5,806
A121-0020	FLTR UNIT NEW 115ML,CN 0.2UM	72	34,731
ADS5035-0004	VT CRYOBOX RK SS;4SHF 3X3X2 IN	Each	9,677
A130-4020	FILTER UNIT/CN,150ML,.2MC STR==	72	42,043
ADS3111-0016	CENT CLOSURE,TUBE PP;16MM	20	1,828
A5036-0009	VT CRYOBOX RK SS;9SHF 5.25X2IN	4	44,946
A140-4045	FILTFNL TYP AF CN;150ML,.45MC	72	40,645
A187-1320	SYR FLTR,N-STR,PTFE;13MM .2M]]	100	21,505
ADS5020-0000	CRYOCANE CODER AL; WHITE	100	2,553
A130-4045	FILTUNIT TYP A CN;150ML.45MC]]	72	42,903
A121-0045	FLTR UNIT NEW115ML;CN0.45UM	72	34,946
ADS5037-0004	VT CRYOBOX RK SS;4SHF 5.25X4IN	Each	12,258
A595-4520	BTLTOP,A-PES,45MM,500ML,75MM]]	12	7,474
A596-3320	BTLTOP,A-PES,33MM,150ML,50MM==	12	5,269
A3743	Screwtube, 500uL w/cap, bulk S	480	26,774
A342820-0115	CLOS, MPV, RED CODER, STERILE PPCO; 11MM	1000	17,204
ADS3111-0030	CENT CLOSURE,TUBE PP;30MM==	20	2,258
A342820-0113	CLOS,MPV ORANGE CODER,STERILE, PPCO;11MM	1000	17,204
A596-4520	BTLTOP,A-PES,45MM,150ML,50MM]]	12	5,638
A569-0020	FLTR,A-PES,500ML,90MM,0.2]]	12	10,947
A455-0500	FLTR RECEIVER, 45MM, PS,500ML]]	12	4,574
ADS3111-0029	CENT CLOSURE,TUBE PP;29MM==	20	2,473
A147-0045	ANYL FILTR FUNL,GREY,CN,0.45	50	16,452
ADS3111-0032	CENT CLOSURE,TUBE PP;32MM	20	2,688
A155-0045	FLT,SFCA,45MM150ML,50MM; .45U==	12	6,774
A296-3345	BTLTOP PES,33MM,150ML,50M;.45U	12	5,484
A3117-1000	CENT TUBE ROUND LIP PC;100ML	40	15,376
A5026-1010	SYSTEM 100 CRYOVIAL BOX, PC]]	10	6,596
A597-3320	BTLTOP,A-PES,33MM,1L,90MM	12	10,645
ADS5037-0007	VT CRYOBOX RK SS;7SHF 5.25X4IN	Each	15,591
A150-0045	FLTR,NYL,45MM,150ML,50MM;0.45U	12	7,957
A150-0020	FLT,NYL,45MM,150ML,50MM;0.2U==	12	7,957
A3744	Screwtube, 500uL w/cap, S	480	29,140
A5A 0007	17mm PS Tube Snp Cap	5000	72,688
A378441	CRYOSTORE CANE, ALUMINUM]]	50	4,149
ADS4101-2000	FLASK, FILTERING, 2L; PP==	Each	2,043
A157-0020	FLTR,SFCA,45MM,250ML,50MM;0.2]]	12	7,419
A125-0080	FLTR,CN,45MM,150ML,50MM;0.8UM	12	6,882
A4170	Tubes, NS Bulk 0.75ML	1000	6,344
A4251	Tubes, RB NS Prt Latch 1.4ML	960	18,495
A3742	Tube Screw 2D S V-Bott no cap	480	28,830
A3776	Tubes, 12 ml trk, racked, NS	96	23,441
A3744RED	Tube, ScrewTop, 500 uL 2D V-Bt	480	44,086
A3744YEL	Tube, ScrewTop, 500 uL 2D V-Bt	480	44,086

Cat No.	Description	Packing	Price Rs.
A3744GRE	Tube, ScrewTop, 500 uL 2D V-Bt	480	44,086
A3744PUR	Tube, ScrewTop, 500 uL 2D V-Bt	480	44,086
A4249	Tubes, RB NS DC 1.4ML	960	13,763
A4274	Tube, .75ml Latch/Alpha Num	960	20,860
A3742AMB	Tube,Screw,AMB,1mL,V-Bott no cap,2D,Str	480	29,462
A342800-0020	VIAL, MPV, STERILE, PPCO; 2ML==	1000	12,128
A4250	Tubes, RB S DC 1.4ML	960	14,624
A3741WHI	Tube, ScrewTop, 1.0 mL 2D V-Bt	480	42,366
A3745AMB	Screwtube, Amb, 500uL,2D, no caps, Str	480	28,602
A3743GRE	Tube, ScrewTop, 500 uL 2D V-Bt	480	43,333
A3743PUR	Tube, ScrewTop, 500 uL 2D V-Bt	480	43,333
A3743RED	Tube, ScrewTop, 500 uL 2D V-Bt	480	43,333
A3743YEL	Tube, ScrewTop, 500 uL 2D V-Bt	480	43,333
A3743AMB	Tube,ScwTp, AMB,0.5mL 2DVB w/Red cap,Str	480	30,215
A3743BLU	Tube, ScrewTop, 500 uL 2D V-Bt	480	30,215
A3743WHI	Tube, ScrewTop, 500 uL 2D V-Bt	480	36,237
A3741AMB	Tube,ScwTp, AMB,1.0mL 2DVB w/Red cap,Str	480	50,860
A4252-11	Tubes, RB S Prt Latch 1.4ML	960	21,183
A374259	2.0mL Cryobank Sterile, No Code, Bulk	960	105,376
A374261	5.0mL Cryobank 2D Barcoded Sterile Bulk	528	63,871
A3740GRE	Tube, ScrewTop, 1.0 mL 2D V-Bt	480	49,247
A3740PUR	Tube, ScrewTop, 1.0 mL 2D V-Bt	480	49,247
A3740RED	Tube, ScrewTop, 1.0 mL 2D V-Bt	480	49,247
A3740YEL	Tube, ScrewTop, 1.0 mL 2D V-Bt	480	49,247
A4148-11	Tubes, Print Polycarb 1.4ML	960	23,441
A374260	5.0mL Cryobank Sterile, No Code, Bulk	528	56,882
A4254	Tubes, RB S Prt DC 1.4ML	960	22,796
A3740WHI	Tube, ScrewTop, 1.0 mL 2D V-Bt	480	42,151
A3740BLU	Tube, ScrewTop, 1.0 mL 2D V-Bt	480	36,129
A3741GRE	Tube, ScrewTop, 1.0 mL 2D V-Bt	480	49,570
A3741PUR	Tube, ScrewTop, 1.0 mL 2D V-Bt	480	49,570
A3741RED	Tube, ScrewTop, 1.0 mL 2D V-Bt	480	49,570
A3741YEL	Tube, ScrewTop, 1.0 mL 2D V-Bt	480	49,570
A3774	Tubes, 12 ml trk, racked, NS	96	22,258
A4470GRE	Caps, Screw Tube, Green, 500/	500	23,441
A4470PUR	Caps, Screw Tube, Purple, 500/	500	23,441
A4470RED	Caps, Screw Tube, Red, 500/cs	500	23,441
A4470YEL	Caps, Screw Tube, Yellow, 500/	500	23,441
A4470WHI	Caps, Screw Tube, White, 500/	500	16,022
ADS5035-0009	VT CRYOBOX RK SS;9SHF 3X3X2 IN	Each	11,935
A4140	Tubes, DW w/Grad NS Bulk 1.4ml	1000	6,809
A710300-0005	VACUUM CAPS FOR REUSABLE FLTR	Each	753
A374001	Nunc Cryostorage Box 13 x 13 (169) replacement divider, 24/case	24	16,711
A373420	Starfoot Tube - 45/pack, 450/box, 1800/case	1800	158,800
A125-0045	FLT,CN,45MM,150ML,50MM;.45UM]]	12	6,882
ADS0399-0001	FORCEPS,FILTER,316 SS]]	Each	3,011
A5000-0050	CRYOGENIC VIAL, PPCO; 5.0ML]]	250	11,170
A167-0045	FLTR,PES,45MM,1L,90MM;0.45UM==	12	15,532
ADS3111-0017	CENT CLOSURE,TUBE PP;17MM	20	2,796
A162-0045	FLTR,SFCA,45MM,500ML,90MM;.45U	12	15,161
A4248	Tubes, RB S Latch 1.4ML	960	13,763
A126-0080	FLTR,CN,45MM,250ML,50MM;0.8UM	12	7,419
A155-0020	FLTR,SFCA,45MM,150ML,50MM;0.2]]	12	7,527
A4247	Tubes, RB NS Latch 1.4ML	960	12,688
A568-0010	Filter, PES, 250mL, 50mm, 0.1	12	6,882
A5036-0004	VT CRYOBOX RK SS;4SHF 5.25X2IN	4	51,183
A5001-1020	CRYOGENIC VIAL, BAR CODED	500	35,699
A122-0045	FLTR UNIT NEW 115ML,SFCA .45UM	72	46,559

Cat No.	Description	Packing	Price Rs.
ADS0222-0020	SYNG/INLIN FLT PTFE; 50MM .2UM	10	9,247
A190-9945	SRNG FLTR BLK SFCA;25MM,.45UM]]	125	40,108
A124-0045	NS 115ML FILT UNIT W/PES0.45UM	72	45,054
A565-0010	Filter, PES, 150mL, 50mm, 0.1	12	7,204
ADS3111-0018	CENT CLOSURE,TUBE PP;18MM	20	2,688
A455-0250	FLTR RECEIVER, 45MM,PS,250ML]]	24	6,489
A3114-0010	CENT TUBE OAK RIDGE FEP;10ML==	10	14,149
A5000-0012	CRYOGENIC VIAL, PPCO; 1.2ML]]	500	17,340
A194-2545	SYRNG FILTR,PES,0.45UM; 25MM]]	50	18,280
A122-0020	FLTR UNIT NEW 115ML;SFCA 0.2UM	72	47,097
A180-1320	SYR FLTR,STRL,PES; 13MM 0.2M]]	50	15,699
A153-0045	FLTR,NYL,45MM,250ML,50MM;0.45U	12	9,140
ADS0320-5045	BLT,FLT,REUSBL,PSF,500ML,45MM==	Each	10,426
A3117-0120	CENT TUBE ROUND PC;12ML	100	15,591
A722-2000	Nalgene Syringe Filter, 25mm diameter, Glass prefilter	50	7,204
A342820-0112	CLOS,MPV YELLOW CODER,STERILE, PPCO;11MM	1000	17,340
A153-0020	FLTR,NYL,45MM,250ML,50MM;0.2==	12	9,247
A723-9945	Nalgene syringe filter .45 µm, 25mm diameter, SFCA membrane	125	18,065
A163-0020	FLTR,NYL,45MM,500ML,90MM;0.2UM	12	18,495
A3741BLU	Tube, ScrewTop, 1.0 mL 2D V-Bt	480	41,505
A151-4045	FLTR,NYL,45MM,500ML,75MM;0.45U	12	14,409
A722-2520	Nalgene Syringe Filter, 0.2 µm CA, 25mm diameter, glass fiber and CA membrane	50	9,570
ASP3794-003	1.4 mL V-Bottom Tubes, Non-Sterile	10	30,645
A3122-V2	Tube Reader, VisionMate Wireless,	Each	290,215
A3114-0050	CENT TUBE OAK RIDGE FEP;50ML==	10	22,340
A3105-0050	CENT TUBE CONICAL PC;50ML	100	23,978
A3117-9500	CENT TUBE ROUND LIP PC;50ML	100	19,462
A5026-0909	CRYOBOX 1.2/2ML PC;9X9 ARRAY]]	24	16,383
A190-2580	SYRINGE FILTER CA;25MM, 0.8UM]]	50	10,860
A565-0020	FLTR,A-PES,150ML,50MM,0.2]]	12	6,702
A190-2545	SYRINGE FILTR SFCA;25MM,0.45U]]	50	10,753
A145-2045	ANAL.TEST FNL CN;0.45MC,250ML]]	50	17,447
A724-2045	Nalgene Syringe Filter .45 µm, 25mm diameter, SFCA membrane	500	60,645
A3744WHI	Tube, ScrewTop, 500 uL 2D V-Bt	480	41,505
A190-9920	SRNG FLTR BLK SFCA;25MM,.2UM]]	125	26,344
AAB1850	2D Tube Reader,VisionMate Highspeed, 1EA	Each	1,548,172
A3741	Tube, Screw 2D S V-Bottom	480	41,613
A374501	Nunc 1.8mL external threaded tubes in latch rack	480	41,398
A567-0010	Filter, PES, 1000mL, 90mm, 0.1um	12	18,511
A710345-0010	FLTR. MANIFOLD STPCK; PTFE	Each	2,903
A151-4020	FLTR,NYL,45MM,500ML,75MM;0.2==	12	14,516
ADS0310-4000	FILTRHOLDER W/FNL PSF;47/50MM	Each	5,806
A190-2520	SYRINGE FILTER SFCA;25MM,0.2U]]	50	10,860
A5005-0015	CRYOGENIC VIAL SPEC PP; 15ML]]	75	7,447
A295-4545	BTLTOPPES,45MM,500ML,75M;45U==	12	7,553
A4896	.75ml Tube Rack, Low Profile	10	8,925
A342800-0005	VIAL, MPV, STERILE, PPCO; 0.5ML==	1000	10,213
A342820-0114	CLOS, MPV GREEN CODER, STERILE,PPCO;11MM	1000	17,766
A4470	Caps, Screw Tube, 500/cs Ster.	500	19,032
ADS3111-0025	CENT CLOSURE,TUBE PP;25MM	20	2,473
A3731-11	.75ml V-Bottom Tube/Latch Rack	960	31,183
A3732	.75ml V-Bot Tube/Latch Rack,S	960	36,129
A455-0150	FLTR RECEIVER, 45MM,PS,150ML]]	24	5,851
A3117-0500	CENT TUBE ROUND PC;50ML	100	16,882
A3730-11	0.75mL 2D tubes, bulk, 1000/cs	1000	19,140
A156-4045	FLTSFCA,45MM,500ML,75MM;.45U==	12	13,936
ADS4101-1000	FLASK FILTERING PP,1000ML]]	Each	1,720

Cat No.	Description	Packing	Price Rs.
A161-0045	FLTR,SFCA,45MM,1L,90MM;0.45UM	12	18,191
A4893	Tube Rack, Snap 10/CS Polycarb	10	10,645
A4890	Tube Rack, Empty Latch 10/CS	10	7,979
A723-2520	Nalgene syringe filter. .22 micron,SFCA, 25mm diameter	50	7,660
A725-2545	Nalgene syringe filter, .45 micron, PES, 25mm diameter	50	6,915
A154-0045	FLTR,NYL,45MM,1L,75MM;0.45UM	12	17,634
A3117-0150	CENT TUBE ROUND PC;15ML	100	15,591
A724-2080	Nalgene Syringe filter.8 µm, 25mm diameter, CA membrane	500	70,108
A3729	.75ml Trak Tubes V-Bt L-Rk Plg	960	41,613
A17-009S	17x100 TTUBE PS w/Blu Snap Cap ST	500	26,452
A3138-0050	CENT TUBE OAKRG W/SCA PC;50ML	50	38,191
A17-001S	17x100 TUBE ONLY No Thread PP ST	1000	23,118
A16-001S	16x125 Tube PS w/clear Screw Cap ST	500	46,344
A12-001S	12x75 TTUBE PP, ST (no cap)	1000	18,172
A17-007S	17x100 TUBE ONLY No Thread PS ST	1000	19,247
A3111-11	2D Tube Reader, VisionMate 96, 1EA	Each	553,118
A3115-11	2D Tube Reader, VisionMate SR, 1EA	1	707,742
A726-2545	Nalgene syringe filter, .45 micron,Nylon, 25mm diameter	50	6,596
A712401-0002	CLSR,STEM,DRAW TUBE;24MM	25	5,269
A296-4545	BTLTOP PES,45MM,150ML,50M;.45U	12	5,319
A726-2520	Nalgene syringe filter, .22 micron,Nylon, 25mm diameter	50	6,596
A158-0020	FLTR,SFCA,45MM,1L,75MM;0.2UM]]	12	17,234
ADS0222-0045	SYNG/INLIN FLT PTFE;50MM .45UM	10	9,247
A195-2545	SYRNG FLTR NYL;25MM.0.45UM]]	50	13,226
A162-0020	FLTR,SFCA,45MM,500ML,90MM;0.2==	12	16,667
A3745	Screwtube, 500uL no caps, S	480	25,914
A195-2520	SYRNG FLTR NYL;25MM, 0.2UM]]	50	13,226
A154-0020	FLTR,NYL,45MM,1L,75MM;0.2UM==	12	17,849
A5025-0505	CRYOBOX 1.2/2ML PC;5X5 ARRAY==	48	21,064
A450-0080	FLTR CN,45MM,500ML,75MM;0.8UM	12	12,688
A450-0045	FLTR CN,45MM,500ML,75MM;0.45]]	12	12,688
A300-4000	FILTRHOLDER W/Rcvr PSF;250ML	4	25,213
A3103-0050	CENT TUBE CONICAL PPCO;50ML	100	30,108
A3734	.5ml Tube 2D NS Latch Rk Trak	960	31,828
A3737	.5ml Tube 2D Ltch S Trk D-Plug	960	46,667
A3710	Tube,2D NS1.4ML 1000Bik Trkmat	1000	22,151
A3736	.5ml Tube 2D Ltch NS Trk D-plg	960	43,763
A3790	Tube, 1.4ml, v-btm trk bulk NS	1000	18,817
A723-2545	Nalgene syringe filter. .45 micron,SFCA, 25mm diameter	50	7,660
A3735	.5ml Tube 2D Latch Rk S Trak	960	39,462
A5045-0005	CRYO CLSR COLOR CD PS; RED==	500	5,484
ADS4101-0500	FLASK FILTERING PP;500ML]]	Each	1,075
A3103-0015	CENT TUBE CONICAL PPCO;15ML	100	20,860
A5045-0003	CRYOGNC CLSR COLOR CD PS; BLU	500	5,484
A4271	Tubes, .75ml NS Latch Rack	960	16,452
A6313-0010	CRYO MARKER SET;4 MARKERS==	24	6,489
A331830	Uni Rack for 1.8mL Ext Tube	10	12,258
A3110-1000	CENT TUBE RNDLIP PPCO;100ML	40	18,602
A12-014	12x75 TTUBE PS,NO CAP,NS	5000	62,903
A374187	MAX-100 CRYOSTORE BOX PC]]	24	42,660
A4272	Tube, .75ml Latch Rack Sterile	960	18,065
A3122	2D Tube Reader,VisionMate Wireless	1	320,000
A727-2045	Nalgene Syringe filter 0.45 µm, 25mm diameter, nylon membrane	500	65,806
A727-2020	Nalgene Syringe filter 0.2 µm, 25mm diameter, nylon membrane	500	65,806
A191-2080	SRNG FILTR BLK CA;25MM,0.8MC]]	50	61,505
A3775	Tubes, 12 ml trk, racked, S	96	21,064
A164-0020	FLTR,NYL,45MM,1L,90MM;0.2UM--	12	22,021
A191-2045	SYRNG FLTR SFCA;25MM, 0.45UM==	50	61,505

Cat No.	Description	Packing	Price Rs.
A3110-0120	CENT TUBE ROUND PPCO;12ML	100	17,419
A3744BLU	Tube, ScrewTop, 500 uL 2D V-Bt	480	42,043
ADS0210-4045	MEMFILTR CA;47MM,.45MC	100	10,745
AAB1389	Tube, 2ml 2DCypher CryoCode, 500/cs	500	39,892
ADS0205-4045	Membrane Filter Ster CN;47mm,0.45U, Wht	Each	10,753
A3148-0050	CONICAL OAKRGDTUBE,PPCO 35ML	100	41,505
A3119-0010	CENT TUBE OAK RIDGE PP;10ML	100	31,809
A867013-0244	GREY 9x9 CRYOBOX, PC	24	16,702
A192-2520	SYRNG FLTR PLUS CA;GF+0.2MC]]	50	14,839
A4900-BR	Empty BR Latch Racks for Matrix Storage Tubes, 500uL	5	9,677
A156-4020	FLTR,SFCA,45MM,500ML,75MM;0.2]]	12	13,936
AAB-1389/1000	Tube, 2ml 2DCypher CryoCode, 1000/cs	500	73,656
A191-2020	SYRNG FLTR SFCA;25MM,0.2UM]]	300	61,613
A342820-0116	CLOS, MPV, BLUE CODER,STERILE, PPCO;11MM	1000	17,021
A720-1320	Nalgene Syringe Filter, Sterile, PES membrane, 0.2 µm, 13 mm diameter	100	12,979
A3110-9500	CENT TUBE ROUND LIP PPCO;50ML	100	26,989
A369647	White Cryobox 81 Tubes 3.6-4.5	30	34,964
A3110-0160	CENT TUBE ROUND PPCO;16ML	100	18,387
A3711	Tube,2D NS Latch 1.4ML Trkmate	960	33,763
A6313-0020	CRYOMARKER, BLACK	24	6,383
A5015-0001	CRYOCANE AL; 5 PLACE]]	48	3,936
A158-0045	FLTR,SFCA,45MM,1L,75MM;0.45UM	12	17,204
A199-2045	SYRNG FILTER .45MC PTFE	50	73,011
A5040-0002	CRYOWARE LABELS PLAIN;1X2 IN.	2000	34,731
A199-2020	SYRNG FILTER .2MC PTFE	300	73,011
A5000-1020	SYS 100 CRYOGENIC VIAL, PPCO 1.5]]	500	29,681
ADS0205-6045	Membrane Filter Ster CN;47mm, 0.45U, Blk	Each	17,634
AAB-1440	Tube, 0.3ml Bulk, 960 tubes/cs	960	57,204
A176-0045	SYRNGFILTR BULK NYL;4MM .45MC-GREEN	400	49,462
A171-0045	SYRNG FILTR BULK CA;4MM .45MC-ORANGE	400	49,032
A157-0045	FLR,SFCA,45MM,250ML,50MM;.45U==	12	7,340
A867013-0245	AST CLRD CRYOBOX, PC	24	17,553
A127-0045	FLTR,CN,45MM,1L,75MM;0.45UM==	12	17,312
A127-0080	FLTR,CN,45MM,1L,75MM;0.8UM	12	17,312
A3138-0030	CENT TUBE OAKRG W/SCA PC;30ML	50	35,806
A196-2020	SYRNG FILTR BULK NYL;25MM,.2MC	50	61,935
ADS0281-9000	PREFILTR GLASS FIBER THIN;90MM	100	7,872
A3117-0380	CENT TUBE ROUND PC;38ML	100	16,989
A17-010	17x100 TUBE ONLY no thread PP NS	1000	17,634
A723-2580	Nalgene syringe filter. .8 micron,CA, 25mm diameter	50	10,860
ADS0320-2545	BTL,FLT,REUSBL,PSF,250ML,45MM	Each	7,766
A176-0020	SYRNGFILTR BULK NYL;4MM .2MC-PURPLE	400	50,538
A196-2045	SYRNGFLT BULK NYL;25MM,.45MC	300	62,581
A17-004S	17x100 TTUBE PP w/clr Snap Cap, ST	500	26,882
A3110-0150	CENT TUBE ROUND PPCO;15ML	100	18,387
A4470BLU	Caps, Screw Tube, Blue, 500/cs	500	15,161
A5001-0020	CRYOGENIC VIAL,BAR CODED	500	24,086
ADS0310-4050	FILTRHOLDR W/FNL PSF;500 ML	Each	9,032
A189-2000	PREFLTR SYRNG BULK 25MM]]	50	10,430
A5027-0909	CRYOBOX 5ML PC;9X9 ARRAY	24	20,851
A5045-0002	CRYOGNC CLSR COLOR CD,PS;YEL	500	5,213
A5045-0004	CRYOGNC CLOSR COLOR CD PS; GRN	500	5,426
ADS0281-7500	PREFILTER,GLASS-FIBER,UNSTERIL	100	6,882
A3114-0030	CENT TUBE OAK RIDGE FEP;30ML	10	20,319
A5001-0050	CRYOGENIC VIAL,BAR CODED	250	18,280
A3750	500 ul 2D tubes, bulk, 960/cs	960	17,419
A3110-0380	CENT TUBE ROUND PPCO;38ML	100	20,000
A867013-0241	YELLOW 9x9 CRYOBOX, PC	24	16,702

Cat No.	Description	Packing	Price Rs.
A4910	Empty tan 384 tube racks,	20	11,828
A17-011	17x100 TUBE ONLY no thread PS NS	1000	20,108
A3118-0085	CENT TUBE OAK RIDGE PC;85ML	100	57,447
A712401-0001	CLSR,STEM,DRAW TUBE;28MM	25	5,376
A342800-0015	VIAL, MPV, STERILE, PPCO; 1.5ML	1000	10,860
A728-2020	Nalgene Syringe Filter 0.2 µm, 25mm diameter, PTFE membrane	500	85,269
A6710-2000	WSTE CNTNR BNCHTOP ACRY;2000ML	Each	16,022
A566-0010	Filter, PES, 500mL, 75mm, 0.1	12	11,702
A12-005S	12x75 PS TUBE 12mm SNAP CP PE ST	500	30,753
A5011-0012	CRYOGNCVL BK NONSTRL PP; 1.2ML	1000	29,140
A3712-11	Tube, 2D S Latch 1.4ML Trkmate	960	47,312
A355501	CRYTUBE COOLER, -20 C,PC;20PL==	1	16,702
A3118-0050	CENT TUBE OAK RIDGE PC;50ML	100	48,723
A3791	Tube, 2D, V-Bottom/Latch Rack	960	45,213
A168-0045	FLTR,PES,45MM,250ML,50MM;0.45U==	12	6,489
A5973-0015	RACK MICROTUBE WHT:1.5ML	8	8,495
A867013-0240	RED CRYOBOX, PC, 9x9	24	17,021
A5000-1012	SYSTEM 100 CRYOGENIC VIAL, PPCO 1.0==	500	32,979
ADS0215-4020	MEMFILTR NYL;47MM 0.2MC]]	100	18,085
A3792	Tube, 2D, V-Bottom/Latch Ster.	960	47,419
A450-0020	FLTR CN,45MM,500ML,75MM;0.2UM]]	12	12,447
A374258	2ml 2D Cryobank, Bulk Pack, Sterile	960	88,191
A4273	Tubes, .75ml Latch/Alpha Num	960	19,355
A127-0020	FLTR,CN,45MM,1L,75MM;0.2UM]]	12	17,553
A3139-0016	CENT TUBE OAKRG W/SC PPCO;16ML	50	31,915
A300-4050	FILTRHOLDR W/RCVR PSF;500 ML	4	39,043
A13-004	13X100 TTUBEPP,NO CAP,NS,4 WH BX/CS	1000	22,796
A12-004S	12X75ST.TUBE ONLY	1000	20,753
A5015-0002	CRYOCANE AL;6 PLACE==	48	4,043
A300-4100	FILTRHOLDR W/RCVR PSF;1000 ML	4	50,426
ADS0320-5033	BLT,FLT,REUSBL,PSF,500ML,33MM	Each	10,319
A867013-0243	BLUE 9x9 CRYOBOX, PC	24	17,021
A223-0030	Carboy Vent Filter, 0.2 Micron	3	13,226
A867013-0242	GREEN 9x9 CRYOBOX, PC	24	17,021
A5012-0012	BLK STRL CRYOGNCVL PP; 1.2ML	1000	35,269
A723-9920	Nalgene syringe filter.22 µm, 25mm diameter, sfca membrane	125	17,872
ADS0315-0047	FUNNEL,FLT/CLMP,PSF;47MM,250ML	Each	10,000
A12-011	12X75 TUBE ONLY, PS	4000	76,882
A12-010	12x75 TUBE ONLY PP NS 1 direction	1000	26,022
A4897	Rack, PC Latch, Screwtube, NS	10	7,660
A3139-0010	CENT TUBE OAKRG W/SC PPCO;10ML	50	27,527
A126-0020	FLTR,CN,45MM,250ML,50MM;0.2UM]]	12	8,617
A374222	5mL Cryobank Uncoded Racked ST	480	47,097
A5055-5015	MICRCNTBX PC;51/4X51/4X2IN==	24	23,511
A166-0045	FLTPES,45MM,500ML,75MM;0.45U==	12	11,064
A710300-0006	VACUUM ADPTRS FOR REUSBLE FLTR	2	860
A5012-0020	BLK STRL CRYOGNCVL, PP;2.0ML==	1000	35,376
A3105-0015	CENT TUBE CONICAL PC;15ML	100	17,553
A3139-0050	CENTTUBE OAKRG W/SC PPCO;50ML	50	16,702
A374221	2mL Cryobank 2D Code Racked Sterile	480	35,532
ADS0281-5000	PREFILTR GLASS FIBER THIN;50MM	100	5,054
A710300-0002	FILT HOLDER REP KIT,ANAL PLATE	Each	2,151
A3119-0028	CENT TUBE OAK RIDGE PPCO;28ML	100	35,699
A13-005	13x100 TTUBE PS (no cap)	1000	27,204
A3137-0050	CENT TUBE OAKRG W/SCA PSF;50ML	50	45,161
A374223	2mL Cryobank Uncoded Racked ST	480	34,468
A341483	MEGA MAX-100 CRYOSTORE BOX PC	24	57,527
A3138-0016	CENT TUBE OAKRG W/SCA PC;16 ML	50	26,702

Cat No.	Description	Packing	Price Rs.
A3815	384 2D Barcoded Tubes,20 racks	7680	285,484
A330821	MICRO MAX CRYOSTORE BOX PC	24	37,340
A710300-0003	FILT HOLDER REP KIT,STER PLATE	Each	2,151
A3119-0030	CENTTUBE OAKRIDGE PPCO;30ML	100	35,213
A3115-0030	CENT TUBE OAK RIDGE PSF;30ML	100	52,151
A3143-0175	CON.CNTRFG BTL PPCO,175ML	36	43,011
A3115-0050	CENT TUBE OAK RIDGE PSF;50ML	100	63,548
A5030-0510	CRYOGENIC VIAL HOLDER, PC	4	9,362
A3119-0050	CENT TUBE OAK RGE PPCO;50ML==	100	43,723
A710300-0004	FILTER HOLDER REPL KIT	Each	1,720
A12-009	12x75 TUBE ONLY PP NS	4000	64,086
A12-012	12x75 TUBE ONLY PS NS 1 direction	1000	30,968
A187-1345	SYR FLT,N-STR,PTFE;13MM.45M]]	100	26,383
A3138-0010	CENT TUBE OAKRG W/SCA PC;10ML	50	21,170
A3118-0030	CENT TUBE OAK RIDGE PC;30ML	100	42,473
A3118-0028	CENT TUBE OAK RIDGE PC;28ML	100	42,581
A169-0045	FLTR,PES,45MM,500ML,90MM;0.45U	12	10,426
A564-0020	50mL Conical Filter Tube==	12	9,785
A5030-0505	SYSTEM 100 CRYOVIAL HLDR,5X5	4	9,032
A125-0020	FLTR,CN,45MM,150ML,50MM;0.2UM]]	12	6,702
ADS0399-0002	FILTER FORCEPS, STRAIGHT TUM]]	Each	2,258
A295-3345	BTLTOP,PES,33MM,500ML,75M;45U	12	7,447
ADS3126-0175	ADAPTER CONICAL CNTRFUGE BTLP	4	3,333
ADS0210-4020	MEMFILTR CA;47MM,.22MC	100	10,319
A16-004	16x125 TUBE ONLY w/o thread PP NS	1000	29,247
A724-2020	Nalgene Syringe filter 0.2 µm, 25mm diameter, SFCA membrane	500	58,830
A4147	Tubes, PolyCarb Rck Prnt 1.4ml	960	23,298
A126-0045	FLTR,CN,45MM,250ML,50MM;0.45==	12	7,340
A292-4520	BTLTOPSFCA,45MM,1L,90MM;0.2UM==	12	12,234
A710300-0001	FILT HOLDER REP KIT,ASST PART	Each	2,151
A5974-0404	FLOATING MICROTUBE RACK PP	16	10,538
A595-3320	BTLTOP,A-PES,33MM,500ML,75MM]]	12	7,021
A3118-0010	CENT TUBE OAK RIDGE PC;10ML	100	39,570
A291-4520	BTLTOP,SFCA;45MM,500ML,75MM.2]]	12	8,191
A5016-0001	CRYOSLEEVE CLEAR PVC==	100	5,319
A5220-384	SampleArray Base; 384- Tubes	Each	3,396,667
A5220-4896	SampleArray Base; 48- and 96- Tubes	Each	2,674,839
A3740	Tube ScrewTop V-Btm S Blk 480/c	480	32,688
A3777	Tubes, 12 ml trk, racked, NS	1	17,527
A331835	Uni Rack for 2.0mL Int Tube	10	11,613
A331825	Latch Rack 2mL Cryobank, NS 10/cs	1	9,677
A331826	Latch Rack 5mL Cryobank, NS 10/cs	1	9,677
A331827	Latch Rack Stft Tubes,Short Lid,NS 10/cs	1	9,570
A331828	Latch Rack Stft Tubes,Tall Lid,NS 10/cs	1	9,570
A369678	Nunc Picker Pen for CryoBank Cap, 24/cas	24	4,243
ADS0215-4045	MEMFILTR NYL;47MM 0.45 MC]]	100	16,064
A524-0020	115ML FILT UNIT W/A-PES	72	46,596
A298-9020	FASTCAP W/PES,0.2UM;90MM,BLUE]]	10	25,000
A3117-0160	CENT TUBE ROUND PC;16ML	100	15,426
A161-0020	FLTR,SFCA,45MM,1L,90MM;0.2UM]]	12	20,745
A5045-0000	CRYOGNC CLSR COLOR CD PS; WHT	500	5,319
A171-0020	SYRNG FILTR BULK CA;4MM .2MC-LIGHT BLUE	400	48,723
A3110-0500	CENT TUBE ROUND PPCO;50ML	100	20,106
A5001-0012	CRYOGENIC VIAL,BAR CODED	500	23,404
A721-1320	Nalgene Syringe Filter, non-Sterile, PTFE membrane, 0.2, 13 mm diameter	100	8,511
A5011-0020	CRYOGNCVL BK NONSTL PP; 2ML	1000	29,255
A374220	5mL Cryobank 2D Code Racked Sterile	480	36,489
A721-1345	Nalgene Syringe Filter, non-Sterile, PTFE membrane, 0.4, 13 mm diameter	100	8,298

Cat No.	Description	Packing	Price Rs.
A3139-0030	CENT TUBE OAKRG W/SC PPCO;30ML	50	30,319
A343850	BLACK CRYOPEN MARKERS	10	6,702
A3144-0175	CONICAL CNTRFUGE BTL PC,175ML	36	45,638
A5974-4015	FLOATING MICROTUBE RK PP;400ML	16	9,787
A5974-1015	FLOTNG MICROTUBE RKPP;1000ML	16	10,638
A728-2045	Nalgene Syringe Filter 0.45 µm, 25mm diameter, PTFE membrane	500	84,149
A342040-0650	BTL,SQ,PET,650ML,W/CLOS,STER]]	48	12,737
A2340-0050	JUG SFTY DISP LDPE;5GAL,20L	4	44,839
A2195-1038	TORQUE FITTING HDPE;38MM	Each	4,301
A3650-0100	BURET TRANSPARENT ACRL;100ML	2	25,591
A145-2020	ANAL TEST FNL CN;0.2MC,250ML==	50	18,065
A2402-0750	WASH BTL UNITARY LDPE;750ML	24	10,645
A4000-0100	FLASK VOLUMETRIC PP;100ML	12	18,172
A145-0020	ANAL TEST FNL 100ML,0.2UM]]	50	16,129
A264710	1536 Well High Base Non-St Clr	25	130,215
A264623	LID FOR 96 WELL PLATE STERILE	60	8,710
A1203-0050	BEAKER PMP GRADUATED; 50ML	36	8,280
A3640-0010	BURET SELF-ZEROING ACRL;10ML	4	22,366
A1201-0150	BEAKER PP GRADUATED;150ML	48	11,398
A712160-0053	GASKET SEALING TPE;53MM	12	1,290
A8000-0010	TBG-180-PVC 1/8X3/16X1/32 50FT	50	1,290
A3640-0050	BURET SELF-ZEROING ACRL;50ML	4	26,882
A4001-0500	FLASK VOLUMETRIC PMP;500ML	8	16,667
A2115-0500	MASON JAR,PP;500ML	24	15,806
A3650-0025	BURET TRANSPARENT ACRL;25ML	4	19,462
A3640-0025	BURET SELF-ZEROING ACRL;25ML	4	23,871
A1203-0100	BEAKER PMP GRADUATED; 100ML	36	9,785
A264612	LID,384 WELL PLATE HTS NONSTR	180	23,978
A4000-0500	FLASK VOLUMETRIC PP;500ML	8	18,065
A249943	V96 POLYPROP PLATE RED NONSTER	120	35,914
A249949	V96 POLYPROP PLATE WHITE NS	120	37,634
A249947	V96 POLYPROP PLATE YELLOW NS	120	37,634
A249950	V96 POLYPROP PLATE BLUE NS	120	37,634
A249945	V96 POLYPROP PLATE BLACK NS	120	37,634
A6304-9811	LASER,POLYPAPR SHEETS;8.5X11IN	300	26,559
A2425-1004	WASHBTL RTK ISOPROP LDPE;1L	12	7,204
A6310	ASY,1X12,IMM 1,FB,100/CS	100	32,258
A264616	LID FOR 384WELL PLT 20/180 ST	180	25,161
A4001-0100	FKASK VOLUMETRIC PMP;100ML	12	17,742
A2425-1002	WSHBTL ETHYL ALCOHOL LDPE;1L	12	7,204
A3664-0025	GRAD CYLINDR ECONOMY PP; 25 ML	18	4,194
A4109-0125	FLASK ERL SCRW CLS PMP;125ML	24	15,914
ADS6630-0250	STIR BAR FLOATING TFE/ETFE	Each	4,946
A2401-0250	WASH BTL ECO LDPE250ML,NM==	36	8,280
A290-3345	BTLTP,SFCA;33MM,150ML,50; 45U]	12	5,376
A3650-0050	BURET TRANSPARENT ACRL;50ML	4	22,903
A2436-1001	WB UN VRTK ACETONE LDPE; 1L	12	10,215
A2405-0500	WSH BTL, AUTOCLV PPCO; 500ML==	24	10,526
A2018-0125	BOTTLE SQUARE HDPE;125 ML	72	6,559
A5700-0500	UTILITY BOX SAN;500ML	12	12,366
A1203-0030	BEAKER PMP;30ML	36	8,065
A5055-5002	MICROCNT TB BX PC,5.25X5.25;.2	24	22,796
A1201-0250	BEAKER PP GRADUATED;250ML	36	11,720
A5100-0001	CONTRL RATE FREZER;1.2/2.0ML]]	Each	6,596
A2425-1005	WASHBTL RTK DWATER LDPE;1L	12	7,312
A5700-0325	UTILITY BOX SAN;325ML	24	15,806
A2436-1005	W/B UN VRTK DIH2O LDPE; 1L	12	10,323
A342820-0117	CLOS, MPV, GOLD CODER, STERILE,PPCO;11MM	1000	17,204

Cat No.	Description	Packing	Price Rs.
A6902-1000	PAN AUTOCLAVING PP;1L	6	7,849
A362825-0115	CLOS, MPV, RED CODER, AMBER PPCO; 11MM	1000	16,774
A342820-0118	CLOS, MPV PURPLE CODER,STERILE,PPCO;11MM	1000	17,204
A2303-0050	CRBY RECT W/TUB HDPE;5GAL	4	21,505
A5700-1000	UTILITY BOX SAN;1000ML	12	13,226
A74040-00	VERSI-DRY; SUPER MAT, 18"X 40"]	175	19,355
A342820-0119	CLOS,MPV,NATURAL CODER,STERILE,PPCO;11MM	1000	17,204
A342820-0111	CLSR,MPV, WHITE CODER, STERILE,PPCO;11MM	1000	17,204
A290-4545	BTLTOP,SFCA,45MM,150ML,50;.45U	12	5,376
A362825-0113	CLOS, MPV, ORANGE CODER,AMBER PPCO; 11MM	1000	16,774
A362825-0112	CLOS, MPV, YELLOW CODER,AMBER PPCO; 11MM	1000	16,774
A342810-0020	VIAL, MPV, PPCO; 2.0ML, EBEAM	1000	13,763
A362825-0114	CLOS, MPV, GREEN CODER, AMBER PPCO; 11MM	1000	16,774
A342023-0125	STER. PETG BTL W/SEPT; 125ML	96	25,699
A362825-1111	CLOS, MPV, AMBER CODER, AMBER PPCO; 11MM	1000	16,774
A362825-0118	CLOS, MPV,PURPLE CODER, AMBER PPCO; 11MM	1000	16,774
A362825-1110	CLOS, MPV, TEAL CODER, AMBER PPCO; 11MM	1000	16,774
A362825-0116	CLOS, MPV, BLUE CODER, AMBER PPCO; 11MM	1000	16,774
A362825-0111	CLOS, MPV, WHITE CODER, AMBER PPCO; 11MM	1000	16,774
A362825-0119	CLOS, MPV,NATURAL CODER,AMBER PPCO; 11MM	1000	16,774
A2002-9016	BTL N/M HDPE;16OZ,500ML	48	12,581
A2195-1438	TORQUE FITTING HDPE;38-430	Each	8,602
A145-0045	ANAL TEST FNL CN;0.45MC]]	50	16,989
A5810-0004	HOLDER,PIPET	Each	15,376
A3664-0250	GRAD CYLINDR ECONOMY PP;250 ML	12	5,054
A235307	SEALING TAPE ADV POLYOLEFIN	100	26,129
A290-3320	BTLTOP,SFCA,33MM150ML,50M;2U==	12	5,484
A362825-0117	CLOS, MPV, GOLD CODER, AMBER PPCO; 11MM	1000	17,204
A4150-9000	FLASK DEWAR HDPE;10L	Each	25,806
A291-3345	BTLTOP,SFCA;33MM,500ML,75;.45U	12	7,634
A2089-0002	BOTTLE NM HDPE;60ML]]	72	2,903
A290-4520	BTLTOP,SFCA;45MM,150ML50M;.2U]]	12	5,484
A312760-0040	CLOSURE,15-415,DRP BTL,GRN,PP	2000	17,097
A312760-0010	CLOSURE, 15-415,DRP BTL,WHT,PP	2000	17,097
A312760-0050	CLOSURE,15-415,DRP BTL,RED,PP	2000	17,097
A312760-0020	CLOSURE,15-415,DRP BTL,YELL,PP	2000	17,097
A1203-0150	BEAKER PMP GRADUATED; 150ML	36	12,688
A2302-0020	CRBY W/TUB LDPE;2GAL,10L	6	21,828
A6700-2418	BENCHTOP BETA SHIELD,18X24	Each	20,215
A7136-0001	BIO-SAFE CARRIER HANDLE	8	10,430
A4102-0250	FLASK ERLNMYR PP;250ML	12	7,097
A312760-0000	CLOSURE, 15-415,DROPPER BTL,PP	2000	17,097
A312760-0060	CLOSURE,15-415,DRP BTL,BLUE,PP	2000	17,097
A4102-0125	FLASK ERLNMYR PP;125ML	24	10,645
A2407-1000	WASH BTL W/M LDPE;1000 ML	12	4,516
A312758-0001	FITMENT,DROPPER,BTL,LDPE,50UL	2000	15,699
A02 0146	90ml/48mm SPC NO LBL, YW CAP, NS	400	11,183
A6255-0918	SAMPLE BAG LDPE;9X18IN	250	18,105
A2126-2000	BTL. HEAVY DUTY PP; 2 LITER	12	27,158
A342825-1111	CLSR,AMB CDR,STER,PPCO,AMB11MM	1000	18,387
A4A 0180	180ml SPC NO LBL, NO CAP, NS	200	7,204
A322089-0002	BTL PKG SW HDPE;2 OZ	1050	56,452
A342023-9500	STER. PETG BTL W/SEPTUM;500EXP	48	19,462
A03 0192	60ml/48mm SPC NO LBL, ORG CAP, NS	500	12,796
A02 1051	90ml/53mm VIAL WH CAP w/Boric Tablet, ST	75	12,796
A74200-00	VERSI-DRY;SUPERROLL,40"X 200"]	200	14,516
A342023-0500	STER. PETG BTL W/SEPTUM; 500ML	40	16,129
A02 0101	90ml/48mm SPCw/LBL, WH CAP, NS	400	11,398

Cat No.	Description	Packing	Price Rs.
A2003-9016	BTL N/M LDPE;16OZ,500ML	48	12,903
A02 0016	90ml/48mm SPCw/LBL, OR CAP, ST	400	12,903
A02 0039	90ml/48mm SPCw/LBL, WH CAP, ST	400	12,903
A02 1105	90ml/53mm SPCw/LBL, YW CAP, NS	400	10,430
A02 1090	90ml/53mm SPC w/LBL, OR CP, ST	400	11,935
A5A 0042	48mm SPC CAP ONLY, WH NS	2000	16,882
A5A 0043	48mm SPC CAP ONLY, RED NS	2000	16,882
A5A 0044	48mm SPC CAP ONLY, GRN NS	2000	16,882
A5A 0050	48mm SPC CAP ONLY, NTL NS	2000	16,882
A03 0006	60ml/48mmSPCw/LBL, OR CAP, ST	500	13,548
A03 0007	60ml/48mmSPCw/LBL, WH CAP, ST	500	13,548
A02 0180	90ml/53mm SPC NO LBL, WH CAP, NS	400	11,935
AAB0559	Thermo-Seal; foil laminate, 85x135mm	100	7,957
A312759-0001	FITMENT, DROPPER BTL, LDPE	2000	15,269
A04 0506	40ml/48mm SPC w/LBL, YW CAP,NS	600	17,527
A5A 0032	35mm SPC CAP ONLY, WH, NS	4000	28,065
A5A 0034	35mm SPC CAP ONLY, GR, NS	4000	28,065
A03 0193	60ml/48mmSPC NO LBL, YW CAP,NS	500	12,366
A02 0148	90ml/48mm SPCw/LBL, YLW CP, NS	400	11,398
A04 0181	40ml/48mmSPC NO LBL, WH CAP,NS	600	13,871
A02 0038	90ml/48mm SPCw/LBL, NTL CAP,ST	400	12,903
A455-1000	RECEIVER,PS; 1000ML]]	12	6,489
A02 1181	90ml/53mm SPC NO LBL, WH CP,NS	300	8,602
A291-3320	BTLTOP,SFCA,33MM,500ML,75M;,2==	12	7,527
A342151-0240	CLOS,HDPE,24-415,BULK, STR==	200	3,011
A260252	U96 DEEPWELL PLATE PP 1ML]]	50	21,053
A342825-0117	CLOS,MPV,GOLD CODER, STER,AMB PPCO;11 MM	1000	18,817
A362015-1000	BTL,SQ PC 1000ML, TRAY W/O CL]]	24	10,860
A342825-0113	CLOS,MPV,ORG CODER, STER,AMB PPCO;11 MM	1000	18,817
A342825-0116	CLOS,MPV,BLUE CODER, STER,AMB PPCO;11 MM	1000	18,817
A3145-0175	CONICAL CNTRFUGE BTL PS,175ML	48	14,624
A342825-0112	CLOS,MPV,YEL CODER, STER,AMB PPCO;11 MM	1000	18,817
A342825-0114	CLOS,MPV,GRN CODER, STER,AMB PPCO;11 MM	1000	18,817
A342825-0118	CLOS,MPV,PURPL CODER,STER,AMB PPCO;11 MM	1000	18,817
A342825-1110	CLOS,MPV,TEAL CODER, STER,AMB PPCO;11 MM	1000	18,817
A342825-0119	CLOS,MPV, NAT CODER, STER,AMB PPCO;11 MM	1000	18,817
A2007-0064	BTL RECT HDPE;64OZ,2000ML]]	12	11,398
A342825-0111	CLOS,MPV,WHT CODER, STER,AMB PPCO;11 MM	1000	18,817
AAB0757	Easy Pierce Foil, 85x135mm	100	6,667
A342830-0115	CLOS, MPV, RED CODER,HDPE; 11MM, EBEAM	1000	20,860
A4469	Tool, Sepra Seal Gripper	Each	27,204
A01 0002	120ml/53mm SPCw/LBL, WH CAP,ST	300	10,108
A362830-0110	CLOSER, NO CODER, HDPE ;11MM	1000	8,495
A342830-0117	CLOS, MPV, GOLD CODER,HDPE; 11MM, EBEAM	1000	20,860
A322020-2000	BTL MEDIA BULK PETG;2000ML	12	11,935
A342830-0113	CLOS, MPV,ORANGE CODER,HDPE; 11MM, EBEAM	1000	20,860
A7102-0140	PAIL AIRTGHT W/CVR LDPE;14QT	6	18,710
A342830-0112	CLOS, MPV,YELLOW CODER,HDPE; 11MM, EBEAM	1000	20,860
A342035-0005	PETG BTL W/LINED CLSR, 5ML,STR	500	43,871
A02 1038	90ml/53mm SPCw/LBL, NTL CAP,ST	300	9,462
A342830-0118	CLOS, MPV,PURPLE CODER,HDPE; 11MM, EBEAM	1000	20,860
A342830-5114	CLOS, MPV, LT GRN CODER,HDPE;11MM, EBEAM	1000	20,860
A342830-0114	CLOS, MPV, GREEN CODER,HDPE; 11MM, EBEAM	1000	20,860
A342830-5110	CLOS, MPV, LT TAN CODER,HDPE;11MM, EBEAM	1000	20,860
A342830-5116	CLOS, MPV, LTBLUE CODER,HDPE;11MM, EBEAM	1000	20,860
A342830-5118	CLOS,MPV,LT PURPL CODER,HDPE;11MM, EBEAM	1000	20,860
A342830-0116	CLOS, MPV, BLUE CODER,HDPE; 11MM, EBEAM	1000	20,860
A342830-0111	CLOS, MPV, WHITE CODER,HDPE; 11MM, EBEAM	1000	20,860

Cat No.	Description	Packing	Price Rs.
A4211-11	Uniblock, NS 1ML	40	26,022
A4474	Insert, Color Code, Green	500	2,473
A342830-0119	CLOS, MPV, NATURAL CODER, HDPE; 11MM, EBEAM	1000	20,860
A02 0122	90ml/48mm SPC NO LBL, NTL CAP, NS	400	11,290
A342023-0060	STER. PETG BTL W/SEPTUM; 60ML	200	38,947
A342825-0115	CLOS, MPV, RED CODER, STER, AMB PPCO; 11 MM	1000	19,247
A2195-1183	TORQUE FITTING, 83MM HDPE; 3/8" DRIVE	Each	21,828
A4A 70400	70/400 SPC CAP ONLY, WH, NS	800	20,000
A5055-5005	MICRCNTBX PC; 51/4X51/4X2IN	24	21,935
A4472	Insert, Color Code, Yellow	500	2,581
A4476-11	Insert, Color Code Purple	500	2,581
A312089-0002	BTL PACKAGING HDPE; 60MLNM==	1000	42,688
A4471	Insert, Color Code Red	500	2,366
A7142-0015	CNTNR LRG W/CVR HDPE; 15L	6	18,172
A4473	Insert, Color Code, Blue	500	2,688
A2318-0020	CRBY W/SPGT LDPE; 2.5 GAL, 10L	6	32,151
A342024-0500	STR PETG BTL W/O CLOS, 500ML==	40	9,785
A2035-0005	PETG BTL W/LINED CLSR, 5ML, STR	100	10,426
AAB0745	Easy-Peel Foil Laminate, 85x135mm	100	10,108
A2118-0004	JAR STRTSIDE W/M PP; 4OZ==	36	6,559
A5242-0040	PIPET JAR XLPE; D	6	46,237
A03 0181	60ml/48mm SPC NO LBL, WHT CP, NS	500	11,828
A07 0005	120ml/53mm SPC NO LBL, WH CAP, ST	100	8,065
A4109	Power Supply, Decapper	1	11,828
A291-4545	BTLTOP, SFCA, 45MM, 500ML75; 45U==	12	7,742
A4954	Lids microplate Stack Automation friendly Clear Sterile	80	16,344
AAB1413	SmartCap Mats, 10 mats/cs	10	12,258
A58334-12	LOOP, 1µL, HIPS, WHITE, N/S	40	11,075
A342035-0020	PETG BTL W/LINED CLSR, 20ML, STR	500	56,129
A4212-11	Uniblock, S 1ML	40	30,108
A12-0350	SNG INOCULUM TRAY, 50/CS	50	23,011
A4A 0250	250ml SPC NO LBL, NO CAP, NS	200	8,065
A4955	Lids microplate Stack Automation friendly Black Sterile	80	26,774
A4105NUN	Handheld Decapper, 8-ch, Nunc	Each	177,742
A7567	STRIP, 1X12, ML 2+, FB, 320/CS	320	31,398
A4470PIN	Cp, 500µl, 1.0 ml ScwTp, PIN, St	500	20,753
A4901	0.75 fixture lid, white,	10	17,204
A4477GRE	ScrewCap Tray, Green Caps	480	28,817
A4477GRY	ScrewCap Tray, Gray Caps	480	28,817
A4477PIN	ScrewCap Tray, Pink Caps	480	28,817
A4477PUR	ScrewCap Tray, Purple Caps	480	28,817
A4477RED	ScrewCap Tray, Red Caps	480	28,817
A4477YEL	ScrewCap Tray, Yellow Caps	480	28,817
A12-0050	DISP INOC, MIC, 50/CS	4	31,720
A4221	Uniblock, NS 2ML	40	36,129
A4308	Wellplate, 384 V-Btm PP Blk NS	80	64,301
A7566	STRIP, 1X12, ML 1+, FB, 320/CS	320	20,968
AAB2558	Adhesive PCR Film, Roll 80mmx100m	1	133,011
AAB2626	Adhesive PCR Foil, Roll 80mmx200m	1	116,774
A3850	Rack, w/latch, 1ml glass trk	480	163,333
A4105MAT	Handheld Decapper, 8-Ch, Matrix	Each	179,462
A3741-WP	1.0mL, 2D, WP, V-Btm, caps, Screw Top, ST	480	93,226
A3741-WP1D	1.0mL, 2D, WP/1D, V-Btm, caps, Screw Top, ST	480	93,226
AAB1750	SmartScan Solo 2D Barcode Reader	Each	395,914
AAB3801	V11 Easy Peel heat sealing foil	Each	154,409
A4220-384	SampleSeal 384 Heat Seal/ Cutter	Each	#####
A4111MAT-IS	Capit-All IS, Capper/ Decapper, 96, Mtrx	Each	#####
AAB2170	ABsolute QPCR Seal Roll	Each	421,505

Cat No.	Description	Packing	Price Rs.
AAB3000	ALPS 3000, Automated Heat Sealer	Each	4,395,269
A4112NUN	Capit All Nunc 24 Way Capper/ Decapper	1	#####
A4114NUN-IS	Capit All IS Nunc 48 Way Capper/Decapper	1	#####
A4111MAT	Capit-All Capper/ Decapper, 96, Mtrx	Each	#####
A4111NUN	Capit All Nunc 96-Capper/Decapper	1	#####
A4113NAL	Capit-All Capper/ Decapper, 24, Nalg EXT	1	#####
A4114NUN	Capit All, Capper/ Decapper, 48, Nunc	1	#####
A3742-WP	1.0mL,2D,WP,V-Btm,ScrewTop,ST	480	70,538
A3742-WP1D	1.0mL,2D,WP/1D,V-Btm,ScrewTop,ST	480	70,538
A4410	Flat Cap Mat, 1ml - 100/case, Round Pierceable	100	23,333
A4110-11	SuperSealer Automated Cap,Seal/ Sepra	Each	768,065
A3744PIN	0.5mL 2D VBt ScwCp w/Pk cp, St	480	43,763
A3744-WP	0.5mL,2D,WP,V-Btm,caps,ScrewTop,ST	480	84,086
A3744-WP1D	0.5mL,2D,WP/1D,V-Btm,caps,ScrewTop,ST	480	84,086
A3745-WP	0.5mL,2D,WP,V-Btm,ScrewTop,ST	480	69,462
AAB0948	3 Height Inserts for ALPS 300	3	32,366
A6305	LID,REMOVAWELL,100/CS	100	14,516
A4412-11	Flat Cap Mat, Sterile 1ML	10	3,656
A04 0195	40ml/48mmSPC NO LBL, ORG CP,NS	600	13,978
A2205	PLATE, 96W, STYRNE, UB, 50/CS]]	50	12,581
A4411-11	Flat Cap Mat, Non-Sterile 1ML	10	3,118
A04 0182	40ml/48mm SPC NO LBL, RED CAP, NS	600	13,978
A235306	SEALING TAPE PE PIERCEABLE	100	32,366
A4902	1.4ml Latch Rack Lids,	10	5,484
A4905	Rack, for lrg screwtop trkNS	10	6,237
A6902-2000	PAN AUTOCLAVING PP;2L	6	10,108
A8000-0006	TBG-180-PVC 3/32X5/32X1/32 50F	50	1,505
A236272	Sealng Tape Wht Vinyl Acrylic Adhes	50	5,054
A04 0180	40ml/48mmSPC NO LBL, NTL CP,NS	600	13,978
A5242-0060	PIPET JAR XLPE;F	2	31,075
A362820-0110	CLSR, MPV, W/O CODER, PPCO; 11MM	1000	8,602
ADS2205-0010	BTL LARGE N/M PC;4L]]	Each	3,511
A2189-0001	BOTTLE WM HDPE;30ML]]	72	4,043
A2126-5000	BOTTLE, HEAVY DUTY, PP; 5L]]	4	18,511
A362089-0004	BTL W/O CLSR,HDPE,125ML,LW]]	500	16,774
A374503	Thermo Scientific, Nunc 2ml Externally T	480	21,738
A374510-BR	Nunc Universal 2.0ml Internally Threaded	480	69,060
AAB0400	Thermo Scientific™ALPS30 Manual Heat Sealer	Each	312,236
A20315	BAGS GENERIC SPECIMEN W	1000	29,206
A3744BLU-BR	Matrix 0.5 ml, 2D, V BTM w/ Blue cap, BC	5	28,498
A2401	Plate Vinyl 96-well UB	Each	14,516
A4325	Deep Well Blocks NS P.P. 384	80	71,612
A2101	Vinyl Alpha 96-well U-Bottom	Each	13,002
A336094	Assorted Internal Thread Cap	250	38,224
A4477	ScrewTop Cap Tray,Clr Caps,	480	24,681
A2751-9125	LAB DRP BTL,WHT,4ML,W/WHT CLS	25	1,828
A2425-0500	ASST RTK WASH BOTTLES	20	14,086
A4463	SepraSeal CapMat, Naturl, NS, 10 mats/cs	10	5,106
A4222	Uniblock, S 2ML	40	40,108
A03 0195	60ml/48mm SPC NO LBL, ORG CAP, NS	500	12,151
A8000-0002	TBG-180-PVC 1/32X3/32X1/32 50F	50	1,505
A2195-0438	TORQUE FITTING PP;38-430	Each	9,892
A2195-6169	TORQUE WRENCH 1/4" DRIVE; 0-75 IN-LB	Each	35,699
A03 0182	60ml/48mm SPC NO LBL,RED CAP,NS	500	12,151
A362800-0005	VIAL, MPV PPCO; 0.5ML]]	1000	9,355
A03 0183	60ml/48mm SPC NO LBL, BL CAP, NS	500	12,151
A7012-0110	BUCKET PP;11QT	6	12,581
A2402-0125	WASH BTL UNITARY LDPE;125ML	48	12,366

Cat No.	Description	Packing	Price Rs.
A2195-0024	TORQUE FITTING PP;24 MM	Each	5,161
A2195-0020	TORQUE FITTING PP;20MM	Each	5,161
A2319-0050	CRBY AUTOCL W/SPGT PP;20L==	4	40,000
A362085-0002	BTL W/O CLSR,AMB HDPE,N/M 60ML	1000	36,667
A2500-0280	DIL BTL N/M GRAD PSF;200ML	48	22,258
A312009-0016	BTL RECT W/CL AMB HDPE;16 OZ	125	41,075
A2009-0016	BTL AMBR RCT HDPE;16OZ,500ML	48	15,806
A2195-0010	TORQUE FIT PP;11MM LOW-PRO CLS	1	5,914
A342151-0200	CLOSURE,HDPE,20-415,BULK, STER	280	3,441
AAB3739	Easy-Peel Foil Laminate, Roll, 78mmx610m	Each	113,333
A710320-0045	REUSABLE BTL REPL GASKET;45MM	5	2,366
A322020-0060	BLKPK MEDIA BULK PETG; 60 ML	200	24,086
A2195-1043	TORQUE FITTING HDPE;43MM	Each	6,667
A2195-1053	TORQUE FITTING HDPE;53MM	Each	6,882
A2115-3000	MASON JAR,PP;3000ML	6	7,742
ADS3132-0RED	SCA for 3141-1006;-1002	6	10,860
A2195-0063	TORQUE FITTING;63MM PP, 3/8" DRIVE	Each	7,419
A2007-0016	BTL RECT HDPE;16OZ,500ML==	48	15,699
ADS3132-BLUE	SCA Cios Assy f/3140-1006;-1002	6	18,065
A1160-1000	STORM WATER MOUNT KIT 1L ALL	Each	9,785
A1201-0100	BEAKER PP GRADUATED; 100ML]]	48	12,581
A2436-0502	W/B UN VRTK ETOH LDPE; 500ML	24	19,570
A2195-0038	TORQUE FITTING PP;38MM	Each	9,247
A4001-0250	FLASK VOLUMETRIC PMP;250ML	12	27,634
A2425-0503	WASHBTL RTK METHANL LDPE;500ML	24	14,409
A6300-1000	NOTEBK LAB POLYPAPER;9X11IN	6	31,505
A2436-0501	W/B UN VRTK ACETONE LDPE;500ML	24	18,925
A5700-2000	UTILITY BOX SAN;2000ML	8	15,161
A264300	GENUNC STORAGE VIALS 2.0ML	500	15,054
A4000-0200	FLASK VOLUMETRIC PP;200ML	12	33,226
A9502867	Black 96 Plate 50 pcs	50	13,333
A2428-0504	RTU WSHBTL LDPE Isopropanol, 500ml	24	16,989
A2195-0153	TORQUE FITTING PP;53B	Each	12,473
A6303-1000	NOTEBK FLD POLYPAPER;9X11-1/4	6	68,065
A2425-0505	WASHBTL RTK DWATER LDPE;500ML	24	13,333
A4001-0050	FLASK VOLUMETRIC PMP;50ML	12	21,505
A2436-0251	W/B UN VRTK ACETONE LDPE;250ML	36	27,742
A5305-1212	VACUUM CHAMBER PEI;12X12	Each	38,495
ADS5250-0060	PIPET CLEANING SET;F	Each	87,957
A2425-0502	WSHBTL ETHYLALCOHOL LDPE;500ML	24	13,333
ADS0405-0050	BUBBLE POINT TEST APPARATUS	Each	207,527
A95040462	Thermo Scientific™ Nunc™ 96-Well Polypropylene DeepWell™ Storage Plates	50	69,032
A4000-0050	FLASK VOLUMETRIC PP;50ML	12	23,763
A2436-0503	W/B UN VRTK MEOH LDPE; 500ML	24	21,290
A7142-0020	CNTNR LRG W/CVR HDPE;20L	6	120,430
A1201-0050	BEAKER PP GRADUATED;50ML	48	11,398
A4001-1000	FLASK VOLUMETRIC PMP;1000ML	6	22,581
A7142-0030	CNTNR LRG W/CVR HDPE;30L	6	121,935
A6506	ASSY, 2X8, IMM 2, FB, 100/CS]]	100	49,032
A2436-0505	W/B UN VRTK DIH2O LDPE; 500ML	24	19,140
A2195-0048	TORQUE FITTING PP;48MM	Each	10,323
A2340-0020	JUG SFTY DISP LDPE;2.5GAL,10L	4	60,000
A2436-0506	W/B UN VRTK BLEACH LDPE;500 ML	24	19,892
A2436-0255	W/B UN VRTK DIH2O LDPE; 250ML	36	27,742
A2425-0501	WASHBTL RTK ACETONE LDPE;500ML	24	21,828
A2436-0504	W/B UN VRTK ISOPROP LDPE;500ML	24	19,355
A6301-3000	NOTEBK,LAB,GRIDDED PAPER, A4	6	13,871
A2195-0053	TORQUE FITTING PP;53MM	Each	10,538

Cat No.	Description	Packing	Price Rs.
A7012-0140	BUCKET PP 14 QT	6	14,946
A4477WHI	ScrewCap Tray, White Caps	480	22,688
A2195-0043	TORQUE FITTING PP;43MM]]	Each	10,323
A2195-1153	TORQUE FITTING HDPE;53B	Each	8,925
AAB2450	Adhesive Crystallography Seal Roll	1	406,237
A2401-0125	WASH BTL ECONOMY LDPE;125ML NM	48	12,688
A2118-0002	JAR STRTSIDE W/M PP;2OZ==	48	5,591
ADS5320-1212	VACUUM JAR PEI; 12X12	Each	28,925
A7102-0080	PAIL AIRTIGHT W/CVR LDPE;8QT	12	28,172
A362805-0005	VIAL, MPV, PPCO; AMBER, 0.5ML	1000	10,215
A2195-1021	TORQUE FITTING HDPE;20MM VIAL	Each	5,269
A2801	PLATE, 96W, VINYL, FB, 100/CS	100	15,806
A2195-0011	TORQUE FITTING,MP VIAL,PP;11MM	Each	5,914
A2195-1024	TORQUE FITTING HDPE;24MM	Each	5,269
A2195-0013	TORQUE FITTING PP;13 MM	Each	5,269
A2195-1020	TORQUE FITTING HDPE;20MM	Each	5,269
A2425-1003	WASHBTL RTK METHANOL LDPE;1L	12	11,398
A2195-0028	TORQUE FITTING PP;28MM	Each	5,699
A2195-1028	TORQUE FITTING HDPE;28MM	Each	5,699
A342020-9500	STER PETG MEDIA BTL EXP 500ML]]	48	12,581
A6501-1000	LABORATORY NOTEBOOK,192PP]]	6	26,452
A322021-0060	SQ MEDIA BTL AMBER PETG;60 ML	200	25,914
A2425-0504	WSHBTL RTK ISOPROP LDPE;500ML	24	13,333
A2425-0506	WASH BTL,BLEACH,LDPE;500 ML	24	13,978
A5038-4322	HZ CRYBX RK,SS;2ML.4X3SHL9X9	2	42,473
A2319-0130	CRBY AUTOCL W/SPGT PP;50L==	Each	17,872
A4300-0250	FUNNEL SEPARATORY PP;250ML	4	16,667
A2505-0280	DIL BTL NM GRAD.PPCO;200ML	48	14,301
A5038-4422	HZ CRYBX RK,SS;2ML,4X4SHL9X9	2	50,860
A2750-9125	LAB DROP BTL,4ML,W/WHITE CLS	25	1,809
A312189-0032	BTL PKG W/M HDPE;32OZ L/W 1L	50	9,894
A7012-0080	BUCKET PP; 8 QT	6	11,398
A3665-0010	GRAD CYLINDR ECONMY PMP;10 ML	24	6,774
A2122-0010	BTL LRG SQR W/M PP;1GAL,4L]]	6	10,638
A6301-4000	NOTEBK,LAB,LINED PAPER,A4	6	14,086
A5315-0150	DESICTR STDNT PP/PC;150MM	6	18,710
A02 1140	90ml/53mmSPC NO LBL, NTL CP,NS	300	8,387
A342820-1110	CLOS, MPV,TEAL CODER, STERILE, PPCO;11MM	1000	22,581
A5A 0052	53mm SPC CAP ONLY, WH NS	1500	13,763
A4000-0250	FLASK VOLUMETRIC PP;250ML	12	32,258
A362820-0113	CLOS, MPV ORANGE CODER, PPCO; 11MM	1000	20,645
A362830-0115	CLOS, MPV, RED CODER, HDPE; 11MM==	1000	20,645
A362830-5114	CLOS, MPV, LT GREEN CODER, HDPE; 11MM	1000	20,860
A4300-0125	FUNNEL SEPARATORY PP;125ML	6	24,301
A362820-0112	CLOS, MPV YELLOW CODER, PPCO; 11MM	1000	20,323
A362830-5110	CLSR, W/LT.TAN CODER,HDPE,11MM	1000	20,860
A342030-0020	VIAL,STRL,CRIMP,PETG,NAT; 20ML	612	29,140
A362830-0114	CLOS, MPV, GREEN CODER, HDPE; 11MM	1000	20,538
A362830-5116	CLOS, MPV, LT BLUECODER, HDPE; 11MM	1000	20,860
A362830-5118	CLOS, MPV, LT PURPLE CODER, HDPE; 11MM	1000	20,860
A362820-0115	CLOS, MPV RED CODER, PPCO; 11MM	1000	20,430
A362830-0118	CLOS, MPV, PURPLE CODER, HDPE; 11MM	1000	20,538
A362830-1110	CLOS, MPV, TEAL CODER, HDPE; 11MM	1000	20,538
A342030-0005	VIAL,STRL,CRIMP,PETG,NAT;5ML	1932	71,505
A322032-0010	PETG THREADED VIAL NAT.; 10ML	1260	50,753
A362820-0114	CLOS, MPV GREEN CODER, PPCO; 11MM	1000	20,323
A362830-0117	CLOS, MPV, GOLD CODER, HDPE; 11MM	1000	20,645
A342033-0010	VIAL,STRL,CT,PETG,AMB; 10ML	1260	54,731

Cat No.	Description	Packing	Price Rs.
A342178-0384	SEPTUM CLOSURE 38-430MM STER	240	49,355
A342030-0010	VIAL,STRL,CRIMP,PETG,NAT; 10ML	1260	52,366
A322032-0005	PETG THREADED VIAL NAT.; 5ML	1656	61,720
A342158-0023	CLSR,LINED,YELW_HDPE,20MM,STER	2000	82,366
A342158-0021	CLOSURE,STERILE,WHITE,20MM	2000	81,398
A312158-0022	20MM LINED CLOSURES, BLACK	2000	83,871
A342032-0005	VIAL,STRL,CT,PETG,NAT;5ML	1656	64,086
A342158-0024	CLSR,LINED,GREN_HDPE,20MM,STER	2000	81,505
A312158-0021	20MM LINED CLOSURE, WHITE	2000	79,462
A322032-0020	PETG THREADED VIAL NAT.; 20ML	612	28,925
A342158-0026	CLSR,LINED,BLUE_HDPE,20MM,STER	2000	81,613
A362830-0116	CLOS, MPV, BLUE CODER, HDPE; 11MM	1000	20,538
A362820-0118	CLOS, MPV PURPLE CODER, PPCO; 11MM	1000	20,323
A362820-1110	CLOS, MPV TEAL CODER, PPCO; 11MM	1000	20,323
A342158-0025	CLSR,LINED,RED_HDPE,20MM,STER	2000	81,828
A342158-0022	CLOSURE,STERILE,BLK,LINED;20MM	2000	84,409
A362820-0117	CLOS, MPV GOLD CODER, PPCO; 11MM	1000	20,430
A322030-0010	PETG CRIMP VIAL NATURAL; 10ML	1260	49,140
A342030-0003	VIAL,STRL,CRIMP,PETG,NAT;3ML	3451	89,355
A362089-0002	BTL W/O CLSR,HDPE,60ML;	1000	40,645
A342032-0010	VIAL,STRL,CT,PETG,NAT; 10ML	1260	52,903
A342032-0020	VIAL,STRL,CT,PETG,NAT;20ML	612	30,645
A362820-0116	CLOS, MPV BLUE CODER, PPCO; 11MM	1000	20,323
A362830-0111	CLOSER, MPV, WHITE CODER, HDPE ;11MM	1000	20,538
A362830-0119	CLOS, MPV, NATURAL CODER, HDPE; 11MM	1000	20,538
A362820-0111	CLOS, MPV WHITE CODER, PPCO; 11MM	1000	20,323
A362820-0119	CLOS, MPV NATURAL CODER, PPCO; 11MM	1000	20,323
A2009-0064	BTL AMB RCT HDPE;64OZ,2000ML]]	12	13,871
A362830-0113	CLOS, MPV, ORANGE CODER, HDPE; 11MM	1000	20,645
A362830-0112	CLOSER, MPV, YELLOW CODER, HDPE ;11MM	1000	20,645
A2402-1000	WASH BTL UNITARY LDPE;1000ML]]	12	6,774
A710320-0001	REUSABLE BTL REPL FUNNEL	4	2,366
A312085-0032	BTL PKG N/M AMBER HDPE;32OZ==	50	9,677
A362085-0004	BTL W/O CLSR;AMB HDPE,N/M125ML	500	19,247
A3664-1000	GRAD CYLINDR ECON PP;1000ML]]	6	5,054
A2115-2000	MASON JAR PP; 2000ML	12	12,581
A3744-BR	Mtx 0.5 mL, 2D, V-Btm w/ Cap, BC Rack	480	40,323
A02 0214	90ml/48 SPCwLB,ORCAP,DSPNSR,ST	400	17,097
A312088-0002	BTL PKG N/M BULK LDPE;2OZ	1000	45,161
A8000-0004	TBG-180-PVC 1/16X1/8X1/32 50FT	50	1,613
A4897-BR	Matrix Barcoded Empty Latch Racks for 1.	1	6,882
A2416-0060	DROPPER BTL LDPE;60ML N/M	48	11,183
A2107-0004	BTL W/M PMP;4OZ,125ML	24	19,355
A374501-BR	Nunc Universal 1.8 ml Externally Threade	480	39,785
A2429-0501	L420- WASH BOTTLE TEFLON	4	29,570
ABC30667	Mtx 1ml,2D Lead MA,WP,w/cp,5 Rk 96/cs,S	1	130,108
A331600-0016	FEP BULK PACK BOTTLES;16 OZ.	50	124,624
A2428-0503	RTU WSHBTL LDPE Methanol, 500ml	24	17,527
A6902-3000	PAN AUTOCLAVING PP;3L	6	13,548
A02CC	2 OZ CUSTODY CLEAR @600	600	48,280
A6378-0004	SAFETY WASTE FUNNEL, 38MM	4	21,383
A95029293	Brk.Strep Combi 8, 5/CS RFG	5	14,946
A312184-0016	BTL PKG WM TRANSAMBR HDPE;16OZ	125	16,237
A5A 0055	53mm SPC CAP ONLY, BLU NS	1500	13,871
A232698	AL SEAL TAPE FOR 96 WELL PLT	100	5,957
A112-0500	I-Chem 500ml HDPE Packer Unprocessed	24	7,097
A5A 0051	53mm SPC CAP ONLY,NTL,NS	1500	13,871
A114-0005	I-Chem 5 Gallon LDPE Cubitainer® Unproce	Case	4,624

Cat No.	Description	Packing	Price Rs.
A1120-1000	STORM WATER SAMPLER 1L	4	15,484
AAB1720	Easy Pierce 20µm Thin Foil; 85x135mm	100	7,742
A01 0001	120ml/53mm SPCw/LBL,OR CAP, ST	300	11,398
A4312	Plate, Well, 384 V-Bottom, PP	80	43,441
ADS2205-0210	BTL LARGE N/M PC;2L]]	Each	1,702
AAB0685	Clear Seal Strong, Polyester, 85x135mm	100	22,796
A4109-0250	FLASK ERL SCRW CLS PMP;250ML	12	10,000
A292-3320	BTLTOP,SFCA,33MM,1L,90MM;0.2UM	12	12,366
AAB0592	Foil Stripper	Each	25,376
A312085-0016	BTL PKG N/M AMBER HDPE;16OZ	125	14,946
A5921-0060	RACK PETRIDISH PC;60MM	2	13,226
A2002-9050	BTL N/M HDPE;1/2 OZ, 15 ML]]	72	3,723
ADS5300-9212	JAR W/COVER PC;18.8L, 12X12IN	Each	15,269
A07 0020	120ml MIDSTREAM KIT STno funnl	100	14,086
A4301-0125	FUNNEL SEPARATORY FEP;125ML	4	24,086
A312189-0004	BTL PKG W/M HDPE;4OZ L/W125ML]]	500	27,742
A6508	Assay, 2X8, Immulon 4, Flat Bottom	100	52,581
A07 0006	120ml/53mmSPC BIOTITeWBL CP ST	100	7,979
A01 0038	120ml/53mm SPCw/LBL,NL CAP,ST	300	11,505
A4309	Wellplates, 384, PP, Sterile	80	45,269
A322085-0002	BTL PKG SW AMB OPAQ HDPE;2 OZ	1050	62,366
A322020-0030	BLKPK MEDIA BULK PETG; 30 ML	280	28,817
A2018-0250	BOTTLE SQUARE HDPE;250 ML	72	10,215
A2203-0010	BTL LRG N/M PP;1GAL,4L	6	10,851
A6255-0406	SAMPLE BAG LDPE;4X6IN	500	15,745
A3665-1000	GRAD CYLINDR ECONMY PMP;1000ML	6	7,849
A2751-9025	LAB DRP BTL,WHT,8ML,W/WHT CLS	25	2,043
A2302-0050	CRBY W/TUB LDPE;5GAL,20L	4	19,355
A342141-0384	Clos.Tamper Evident, HDPE, 38-430, Ster	240	8,387
A900-4000	L900 LIQUID DETERGENT; 4L	4	10,860
A2752-9125	LAB DROP BTL, 4ML, W/ASST CLS	25	2,043
A2750-9025	LAB DROP BTL, 8ML, W/WHITE CLS	25	2,043
A01 0182	120mL/53mm SPC,No Lbl,Red Cap,NS,Blk Pk	300	9,570
A342805-0005	VIAL, MPV, STERILE, PPCO; AMBER, 0.5ML	1000	11,398
A276011	Nunc 96 well cap mat,NS	50	23,118
A6505	Assay, 2X8, Imm Ulon 1, Flat Bottom	100	47,312
A342089-0032	BOTTLE,N/M,HDPE,1000ML,STER==	24	7,660
A2500-0380	DIL BTL W/M GRAD. PSF;205ML	48	26,237
A362826-0111	CLOSER, MPV, WHITE PPCO ;13MM	1000	9,677
A342826-0114	CLOS, MPV, STERILE GREEN PPCO; 13MM	1000	10,645
A2202-0005	BTL LRG N/M LDPE;1/2GAL,2L]]	6	5,699
A01 0101	120ml/53mm SPCw/LBL, WH CAP,NS	300	10,215
A322089-0004	BTL PKG SW HDPE;4 OZ	300	19,892
A4102-1000	FLASK ERLNMYR PP;1000ML	6	7,527
A2751-9050	LAB DRP BTL,WHT,15ML,W/WHT CLS	25	2,151
A3665-0100	GRAD CYLINDR ECON PMP;100 ML==	12	6,774
A2422-2500	WSHBTL COLORCD YLLW LDPE;500ML	24	7,957
A2750-9050	LAB DROP BTL,15MLW/WHITE CLS==	25	2,151
A342024-0125	STER. PETG BTL W/O CLS, 125ML]]	96	12,258
A6902-5000	PAN AUTOCLAVING PP;5L	6	14,946
A2035-0010	PETG BTL W/LINED CLSR,10ML,STR	100	11,489
A2422-5500	WSHBTL COLORCD RED LDPE;500ML	24	7,957
A2422-4500	WSHBTL COLORCD GREN LDPE;500ML	24	7,957
A01 0100	120ml/53mm SPCw/LBL, YLW CAP,NS	300	10,215
A6505-0010	BTL CARRIER SAFETY LLDPE;500ML	6	32,872
A2126-1000	BTL. HEAVY DUTY PP; 1 LITER	24	41,809
A2103-0016	BTL W/M LDPE;16OZ,500ML]]	48	11,489
A4900	Rack, pc, latch ,500uL st, NS	5	8,065

Cat No.	Description	Packing	Price Rs.
A4432-11	Round Cap Mat, Sterile, 1.4/.75ML	10	4,409
A312089-0032	BTL PACKAGING HDPE;32OZ NM1L]]	50	8,602
A4899	.5ml Rack Latch w/Lg Cover NS	10	11,398
A4414-11	Cap Strips, S Separable	240	17,097
AAB3797	Clear Seal Thin, Polymer, Roll 78mmx610m	Each	31,613
A362089-0016	BTL W/O CLSR,HDPE,500ML,L/W	125	11,505
AAB3686	Clea Seal Strong,Polyester,Roll78mmx610m	Each	342,581
A02 0501	90mL/48mm SPC w/LBL, NO CAP, NS	400	9,677
A1201-0600	BEAKER PP GRADUATED; 600ML	24	15,161
A4300-0500	FUNNEL SEPARATORY PP;500ML	4	18,817
A312018-0125	BOTTLE SQUARE HDPE;125 ML	250	29,355
A342020-0500	STER. PETG MEDIA BTL., 500ML]]	40	11,383
A249946	V96 POLYPROP PLATE NATURAL ST	120	34,255
ADS3131-0024	CENT SLNGCP ASSY ETFE;24MM	2	1,489
A1203-1000	BEAKER PMP GRADUATED; 1000ML	12	12,688
A342024-0030	STER. PETG BTL W/O CLOS, 30ML	280	29,355
A430082	8 WELL STRIP CAP, P.E. NON-STR	180	13,871
AAB3720	EasyPierce 20µm Thin Foil Roll 78mmx610m	Each	83,118
A322021-0125	SQ MEDIA BTL AMBER PETG;125 ML]]	96	15,269
A2002-9125	BTL N/M HDPE;1/8 OZ, 3.8 ML]]	72	3,298
AN411-0125	Nalgene WM HDPE Sterile Sample Bottle with Closure,125mL	48	20,430
A4413-11	Cap Strips, NS Separable	240	7,849
A01 0051	120/53 ST WH CP W/ SODIUM THIO	300	14,301
A6255-0913	SAMPLE BAG LDPE;9X13IN==	250	16,064
A4906	Screw Cap Tray, Empty, 5 Trays	10	5,484
AAB0812	Diamond Clear Seal, Polmer, 85x135mm	100	5,161
A6255-0613	SAMPLE BAG LDPE;6X13IN	250	13,830
A312097-0004	BTL,N/M,BULK,FLUOR,HDPE;4 OZ	500	53,978
A07 0010	90ml MIDSTREAM KITw/FUNNEL ST	50	10,860
AAB3799	Diamond ClearSeal Polmer Roll, 78mmx370m	Each	23,548
AAB3559	ThermoSeal,foil laminate,Roll,78mmx370m	Each	80,645
A4898	.5ml Rack Latch w/Cover NS MT	10	10,968
ADS3131-0020	CENT SLNGCP ASSY ETFE;20MM	2	1,398
A312184-0004	BTL PKG WM TRANS AMBR HDPE;4OZ	500	29,892
A312097-0016	BTL,N/M,BULK,FLUOR,HDPE;16 OZ	125	27,204
A2422-3500	WSHBTL COLORCD BLU LDPE;500ML	24	8,065
A3141-0500	CENT BTL W/SCA PPCO; 500 ML	24	36,596
A8000-0020	TBG-180-PVC 1/8X1/4X1/16 50FT]]	50	2,473
A2104-0004	BTL W/M HDPE;4OZ,125ML]]	72	8,511
A342820-0110	CLSR, MPV, W/O CODER, STERILE, PPCO;11MM	1000	8,511
A6405	ASY,1X12,IMM 4,FB,100/CS	100	52,796
A322085-0004	BTL PKG SW AMB OPAQ HDPE;4 OZ	300	21,720
A249720	SEALING TAPE WHITE RAYON	50	10,108
A362085-0032	BTL W/O CLSR;AMB HDPE,N/M1000M	50	9,032
A4466	SepraSeal Capmat PrSpl, Ntl, S, 10 /cs	10	6,022
A3665-0025	GRAD CYLINDR ECONMY PMP;25 ML	18	6,129
A2425-0507	Wash Bottle RTK Deionzed LDPE;500mL	24	16,022
A4108-0125	FLASK ERL SCRW CLS PC;125ML	24	14,409
A264573	384 WELL PP PLATE NATURAL NS	120	84,516
A6501-4000	BTL CARRIER SAFETY LDPE;4L	6	32,234
A4464	SepraSeal Capmat, Naturl, S, 10 mats/cs	10	5,591
A4301-0250	FUNNEL SEPARATORY FEP;250ML	4	27,419
A232699	AL SEAL TAPE FOR 384 WELL PLT	100	7,957
A2107-0008	BTL W/M PMP;8OZ,250ML	24	22,366
A312089-0016	BTL PACKAGING HDPE; NM500 ml]]	125	13,441
A342024-0060	STER. PETG BTL W/O CLOS, 60ML==	200	25,269
A8020-0250	TBG-689-PP 3/16X1/4X1/32 100FT	100	3,656
A342089-0016	BOTTLE, N/M,HDPE,500ML,STERILE	120	19,247

Cat No.	Description	Packing	Price Rs.
A01 0195	120ml/53mm SPC,No Lbl,Org Cap,NS,Blk Pk	300	9,570
A01 0181	120ml/53mmSPC NO LBL,WH CP, NS	300	9,570
A3120-1000	CENT BTL PPCO;1000ML==	16	20,213
A6301-1000	NOTEBK LAB PAPER;8.5X11]]	6	8,817
A312084-0002	BTL PKG TRANS AMBER HDPE;2 OZ	1000	48,817
A6301-2000	NOTEBK,LAB LINEDPAPR;8.5X11IN]]	6	9,462
A02 1016	90ml/53mm SPC w/LBL, WH CAP,ST	300	18,710
A312184-0008	BTL PKG WM TRANS AMBR HDPE;8OZ	250	22,258
A01 0183	120ml/53mm SPC NO LBL,BL CAP,NS,BLK	300	9,570
A01 0180	120ml/53mm SPC,No Lbl,Natl Cap,NS,Blk Pk	300	9,570
ADS2327-0050	FLUORO RECT. CRBY W/SPGT 20L	Each	9,462
A312084-0016	BTL PKG TRANS AMBER HDPE;16 OZ	125	14,839
A2405-1000	WASH BOTTLE AUTOCLAV PA;1000ML	12	7,447
A2203-0020	BTL LRG N/M PP;2GAL,8L	6	18,085
A4415	Cap Strips, Non-Sterile, Non Separable, Round Pierceable	240	10,000
A6140-0010	VACUUM PUMP WATER PP	24	19,677
A1100-1000	STORM WATER SAMPLER 1L HDPE	4	10,000
A342826-0111	CLOS, MPV, STERILE WHITE PPCO; 13MM	1000	10,638
A342800-0045	VIAL,MICRO,PKG,PPCO;4.5ML,STER	1000	18,085
A322089-0001	BTL PKG SW HDPE;1 OZ	1050	54,624
A312007-0016	BTL RECT W/CLOS HDPE; 16 OZ	125	31,505
A312089-0004	BTL PACKAGING HDPE;4OZ 125ML==	500	24,086
A01 0192	120ml/53mm SPC w/LBL, Org Cap, NS, BLK	300	9,785
A5930-0030	RACK TT PP;30MM	4	16,237
A382003-0016	Bottle NM LDPE LP LM Cert 16oz	48	49,032
A01 0092	120ml/53mm SPC w/LBL,Org Cap,Sterile	300	11,505
A6131-0010	VACUUM PUMP HAND;15CC	4	26,452
A17-005S	17x100 TEST TB w/clear Snap Cap ST	500	40,108
A312088-0016	BTL PKG N/M BULK LDPE;16OZ L/W	125	13,763
A2505-0380	DIL BTL WM GRAD.PPCO; 205ML	48	16,989
A4470ORG	Cp, 500µl, 1.0 ml ScwTp, ORG, St	500	14,946
A6917-0230	AUTOCLV BSKT PP;230X230X230 MM	6	10,538
A312085-0002	BTL PKG NM AMBER HDPE;2 OZ	1000	49,892
A8050-0437	TBG 890 FEP; 3/8 X 7/16 50FT	50	20,430
A2753-9050	LAB DRP BTL,WHT,15ML,W/AST CLS	25	2,366
A8000-1090	TBG-180-PVC 5/16X7/16X1/16 10ft 50ft/cs	50	5,914
A4-001	4.0 ML SAMPLE CUP	10000	62,473
A2752-9050	LAB DROP BTL, 15ML, W/ASST CLS	25	2,366
A312187-0016	BTL PKG W/M PP;16OZ	125	17,312
A1203-0600	BEAKER PMP GRADUATED; 600ML	12	10,645
A342023-1000	STER. PETG BTL W/SEPTUM;1000ML	24	16,452
A374511	2.0mL Int Uncoded WP Grads UniLatch Rack	480	39,785
A4109-1000	FLASK ERL SCRW CLS PMP;1000ML	6	10,860
A4470BLK	Cp, 500µl, 1.0 ml ScwTp, BLK, St	500	14,946
A374510	2.0mL Int 2D WP Grads UniLatch Rack	480	79,462
A6565-0001	4-in-1 EZ Tote TM, HDPE, Blue	4	8,830
A6501-2500	BTL CARRIER SAFETY LDPE;2.5L	6	27,766
A6309	ASY,1X12,IMM 2,FB,100/CS	100	49,570
A312184-0032	BTL PKG WM TRANS AMB HDPE;32OZ	50	10,753
A02 1104	90ml/53mm SPCw/LBL, NTL CAP,NS	300	10,323
A5930-0020	RACK TT PP;20MM	4	15,914
A5930-0013	RACK TT PP;13MM	4	16,237
A342044-0125	BTL,SQ.PET,125ML,W/O CLS,STR]]	96	8,495
A382003-0032	Boittle NM LDPE LP LM Cert 32oz	24	29,140
A2323-0008	CRBY LOWBOY W/SPGT HDPE;8L	4	27,634
A3120-1010	CENT BTL PPCO IEC;1000ML	16	20,106
A4091	Capit All; ScrwTp Cp Try Liftr 1ml Mtx	1	34,194
A312088-0004	BTL PKG N/M BULK LDPE;4OZ L/W	500	25,484

Cat No.	Description	Packing	Price Rs.
A2018-0500	BOTTLE SQUARE HDPE;500 ML	48	9,677
A8000-0025	TBG-180-PVC 5/32X7/32X1/32 50F	50	2,043
A15-002	15ml CENT TB NS no cap Conical	500	10,645
A2018-0060	BOTTLE SQUARE HDPE;60 ML	72	5,806
A312187-0004	BTL PKG W/M PP;4OZ L/W125ML	500	31,828
A6310-0010	PEN,LAB,BLK==	12	3,298
A2099-0010	BTL IP2 NM HDPE; 1 GAL]]	6	9,032
A374512	2.0mL Int 2D WP Grads Bulk	480	70,538
A5930-0016	RACK TT PP;16MM	4	16,237
A1203-0400	BEAKER PMP GRADUATED; 400ML	24	17,204
A4250-0045	FUNNEL ANALYTICAL PP;45MM	36	6,129
AAB1118	Plate Carrier, Combi-Sealer,AB-1058	Each	36,452
A01 0052	120/53 ST WH CP W/ SODIUM THIO	300	15,161
A3125	2D Reader, VisionMate ST, 1EA	1	197,634
A74043-00	VERSI-DRY;SUPER TABLE20"X43"]]	150	26,809
A236703	Sealing Tape Black Vinyl 50/cs	50	6,344
A322089-0008	BTL PKG SW HDPE;8 OZ	300	28,817
A6131-0020	VACUUM PUMP HAND;36CC	4	33,441
AAB0827	Standard Microplate Carrier	Each	30,215
A4464BLU	SepraSeal Capmat, Blue, S, 10 mats/cs	10	7,097
A4464GRE	SepraSeal Capmat, Green, S, 10 mats/cs	10	7,097
A4464GRY	SepraSeal Capmat, Gray, S, 10 mats/cs	10	7,097
A4464PUR	SepraSeal Capmat, Purp, S, 10 mats/cs	10	7,097
A4464RED	SepraSeal Capmat, Red, S, 10 mats/cs	10	7,097
A4464YEL	SepraSeal Capmat, Yelw, S, 10 mats/cs	10	7,097
A8050-0562	TBG 890 FEP; 1/2 X 9/16; 50FT	50	26,989
A713140-00PC	BLU O-rings f/3140-1006;-1002	6	11,075
A3645-2550	BURET KIT SELFZERO;25ML,50ML	4	5,376
A4109-0500	FLASK ERL SCRW CLS PMP;500ML	12	15,054
AAB0563	96W BasePlate Anodised Alum PlateCarrier	Each	54,086
A342020-1000	STER PETG MEDIA BTL.; 1000ML]]	24	14,149
A2436-0507	W/B UnitaryVRTK Deionzd LDPE;500mL	24	18,387
A312189-0008	BTL PKG W/M HDPE;8OZ L/W250ML]]	250	20,860
A2121-0005	BTL LRG W/M PP;1/2GAL,2L]]	6	7,021
A2097-0016	BTL,N/M,FLUOR,HDPE;16 OZ	48	11,398
A02 1106	90ml/53mm SPC w/LBL, WH CP, NS	300	17,849
A712151-0200	HDPE CLOSURE 20MM;WHITE	12	745
A07 0007	90ml/48mmSPC NO LBL, BL CAP,ST	100	9,892
ADS0390-0070	BELL,FILLING,PC;70MM]]	Each	3,085
A374502	1.8mL External 2D WP Bulk	480	77,097
A5A 0006	17mm clear SNAP CAP, ST	2000	42,796
A4031	100X25MM DEEP PETRI DISH]]	300	27,527
A312088-0032	BTL PKG N/M BULK LDPE;32OZ L/W	50	9,140
A250005	LID UNIVERSAL CLEAR NS 20/180	180	36,667
A250003	LID UNIVERSAL CLR NS 20/60	60	12,258
A2097-0010	BTL NM FLUOR HDPE 4LITER	6	10,968
A02 1192	90ml/53mm SPC w/LBL, OR CAP NS	300	11,613
A2018-0030	BOTTLE SQUARE HDPE;30 ML	72	5,699
A2089-0001	BOTTLE NM HDPE;30 ML]]	72	2,796
A4102-0500	FLASK ERLNMYR PP;500ML	12	9,785
A4705	32 OZ. DISP CONTAINER PP, NS	120	9,140
A362089-0032	BTL W/O CLSR,HDPE,1000ML,L/W==	50	8,172
A4714	86 OZ. DISP CONTAINER PE, NS	24	4,731
A342810-0005	VIAL,MPV,PPCO;0.5ML,EBEAM	1000	14,194
A2089-0004	BOTTLE NM HDPE;125ML==	72	3,871
A4704	16 OZ. DISP CONTAINER PS, NS	120	7,419
A2087-0002	60ml PP NM Economy Bottle	72	2,903
A3665-0050	GRAD CYLINDR ECONMY PMP; 50 ML	18	7,742

Cat No.	Description	Packing	Price Rs.
A312016-0125	BOTTLE SQUARE PP;125ML	250	36,989
A2097-0005	FLUOR BTL;1/2GAL 2000ML	6	8,065
A4713	32 OZ. DISP CONTAINER PS, NS	100	14,731
A3665-0250	GRAD CYLINDR ECONMY PMP;250 ML	12	9,140
A4021	100X15MM SQUARE PETRI DISH]]	500	114,301
A4250-0055	FUNNEL ANALYTICAL PP;55MM	36	6,452
A312750-9125	DROPPER BOTTLE, LDPE 4ML	2000	44,301
A460001	U8 OEM PACK POLYSORP]]+	120	43,656
A362089-0001	BTL W/O CLSR,HDPE,30ML,L/W	1000	31,828
A3665-0500	GRAD CYLINDR ECONMY PMP;500ML	8	8,495
A6133-2000	Repair Kit for New Style Metal Hand Pump	4	16,129
A2007-0004	BTL RECT HDPE;4OZ,125ML]]	72	7,849
A4715	172 OZ. DISP CONTAINER PE, NS	20	8,172
A2187-0032	1000ml PP WM Economy bottle	24	4,946
A374500	1.8mL External 2D WP Uni Latch Rack	480	89,785
A2319-0020	CRBY AUTOCL W/SPGT PP;10L	6	48,298
A2187-0016	500ml PP WM Economy bottle	48	7,527
A6250-0005	SAMPLE VIAL W/CLSR LDPE;5ML	144	6,022
A6250-0012	SAMPLE VIAL W/CLSR LDPE;12ML	144	6,667
A312084-0004	BTL PKG TRANS AMBER HDPE; 4 OZ	500	27,419
A382003-0008	Bottle NM LDPE LP LM Cert 8oz	72	68,817
A2087-0032	1000ml PP NM Economy Bottle	24	4,409
A2187-0008	250ml PP WM Economy bottle	72	6,129
A332189-0032	BULK PK HDPE WM BTL; 32 OZ.]]	50	9,677
A3141-1006	Centrifuge Btl SC PPCO 1000mL	6	41,383
A2087-0008	250ml PP NM Economy Bottle	72	5,376
A4301-1000	FUNNEL SEPARATORY FEP;1000ML	4	46,129
A332189-0016	BULK PK HDPE WM BTL;16 OZ==	125	17,849
A332089-0032	BULK PK HDPE NM BTL;32 OZ.	50	9,140
A6319-0010	Polyolefin Label, 0.9 x 0.9	4000	18,280
A6319-0015	Polyolefin Label, 0.8 x 1.5	3250	18,280
A6319-0020	Polyolefin Label, 1 x 2.63	1500	18,280
A6319-0040	Polyolefin Label, 2 x 4	500	18,280
A2089-0032	BOTTLE NM HDPE;1000ML==	24	4,301
A3662-0025	GRADUATED CYLINDR PPCO; 25ML	18	17,097
A374500-BR	Nunc Universal 1.8 ml Externally Threade	480	86,022
A332089-0016	BULK PK HDPE NM BTL;16 OZ.	125	14,301
A332089-0004	BULK PK HDPE NM BTL;4 OZ.	500	25,914
AAB1860	1D Reader, VisionMate HS Accessry, 1EA	Each	101,613
A332189-0004	BULK PK HDPE WM BTL;4 OZ	500	32,903
A332189-0002	BULK PK HDPE W/M BTL; 2 OZ.	1000	48,280
A332089-0008	BULK PK HDPE NM BTL;8 OZ.	250	17,312
A342826-0110	CLOS, MPV, STERILE PPCO;13MM	1000	10,753
A332189-0008	BULK PK HDPE WM BTL;8 OZ.==	250	21,398
A362089-0008	BTL W/O CLSR,HDPE,250ML,L/W	250	15,376
A2089-0016	BOTTLE NM HDPE;500ML	48	5,484
A2187-0004	125ml PP WM Economy bottle	72	4,946
A12-008	12x75 TT PP w/clear Snap Cap NS	1000	29,892
A4110-0500	FLASK BAFFLED PC;500ML	12	13,333
A2187-0001	30ml PP WM Economy bottle	72	2,903
A2187-0002	60ml PP WM Economy bottle	72	3,763
A2087-0001	30ml PP NM Economy Bottle	72	3,226
A5500-0010	PETRI DISH PMP;100MMX15MM	60	26,022
A02 1102	90ml/53mm SPCw/LBL, WH CAP, NS	300	11,183
A12-007S	12x75 TT PS w/Clear Snap Cap ST	1000	29,570
A312187-0032	BTL PKG W/M PP;32OZ L/W	50	11,398
A2123-0010	BTL LRG SQR W/M HDPE;1GAL, 4L]]	6	9,570
A2411-0015	DROP DISP BTL LDPE;15ML N/M	72	10,430

Cat No.	Description	Packing	Price Rs.
A2087-0016	500ml PP NM Economy Bottle	48	5,376
A2087-0004	125ml PP NM Economy Bottle	72	3,978
A312087-0002	BTL PACKAGING NM PP;2OZ 60ML	1000	53,763
A2318-0130	CRBY W/SPGT LDPE;13GAL==	Each	13,871
A322085-0001	BTL PKG SW AMB HDPE;1 OZ	1050	60,323
A2197-0004	BTL,W/M,FLUOR,HDPE;4 OZ	72	11,505
A5A 0012	12mm HOLLOW CAP ONLY, NATURAL	10000	82,043
A5550	LID, STERILE, IND WRP,50/CS	50	13,441
A2595-3038	TORQUE FITTING, BIOTAINER 38MM	Each	14,194
A362006-9025	PP BOTTLE W/O CLOS,1/4 OZ BULK	2000	50,215
A4300-1000	FUNNEL SEPARATORY PP;1000ML	4	23,226
A312007-0004	BTL RECT W/CLOS HDPE; 4 OZ	500	55,161
ADS2205-0250	BTL LARGE N/M PC;2.5L	Each	1,935
A1201-1000	BEAKER PP GRADUATED;1000ML==	12	9,570
A382003-0004	Bottle NM LDPE LP LM Cert 4oz	72	65,269
A362150-5384	COLOR CLSR,PP,38-430,RED	250	7,527
A2595-9048	TORQUE ADAPTOR,48MM,QK/A	Each	14,194
A312185-0008	BTL PACKAGING WM AMBER 8 OZ	250	22,688
A2318-0050	CRBY W/SPGT LDPE;5GAL,20L==	4	31,613
A312084-0032	BTL PKG TRANS AMBER HDPE;32 OZ	50	9,892
A312085-0004	BTL PKG N/M AMBER HDPE;4OZ LW	500	27,419
A362002-9025	BTL W/O CLSR,HDPE,8ML,NAT	2000	48,710
A374320	LP 5mL, 2D, WP, Latch Rk, S,10 rks 24/cs	480	65,376
A2006-0001	BTL N/M PP;1OZ,30ML==	72	5,000
A2099-0016	BTL IP2 N/M HDPE;500ML,16OZ	48	9,787
A342151-0384	CLOS,HDPE,38-430,BULK,STER==	240	6,989
A4250-0065	FUNNEL ANALYTICAL PP;65MM	36	7,527
A2323-0015	CRBY LOWBOY W/SPGT HDPE;15L	4	30,968
A312097-0008	BTL,N/M,BULK,FLUOR,HDPE;8 OZ	250	38,817
A2004-9125	BTL N/M AMBR HDPE;1/8 OZ,3.8ML==	72	5,638
A8050-0500	TBG 890 FEP; 7/16 X 1/2; 50FT	50	25,914
A2097-0008	BTL,N/M,FLUOR,HDPE;8 OZ	72	12,258
A312751-9125	DROPPER BTLE, WHITE, LDPE, 4ML	2000	46,774
A3127-0250	CENT BTL FEP;250ML	6	40,426
A312189-0002	BTL PKG W/M HDPE;2OZ L/W60ML	1000	50,538
A2117-1000	JAR STRTSIDE W/M PMP;1000ML]]	16	13,656
A374323	LP 5mL,non2D,WP,Loose Pk, Ster,240/cs	240	36,989
A312088-0008	BTL PKG N/M BULK LDPE;8OZ L/W	250	19,355
A1510-0250	BEAKER PFA; 250 ML	6	28,172
A374321	LP 5mL,non2D, WP,Latch Rk,S,10 rks 24/cs	480	48,817
A3663-1000	GRADUATED CYLINDR PMP;1000ML	6	17,204
A250002	LID UNIVERSAL CLR ST 20/60	60	13,656
A5250-0040	PIPET CLEANING SET;D	Each	30,323
A342024-0250	STERL.PETG BTL W/O CLS, 250ML==	60	12,903
A2107-0016	BTL W/M PMP;16OZ,500ML	16	19,247
A264579	384 WELL PP PLATE BLUE NONST	120	99,140
A2202-0010	BTL LRG N/M LDPE;1GAL,4L]]	6	8,298
A4090	ScrwTop Cap Ty Lftr Capit All, 0.5mL Mtx	1	34,409
A2189-0016	BOTTLE WM HDPE;500ML]]	48	7,204
A6133-0010	REPR HANDPUMP W/GAGE MET. 15CC	4	52,043
A342002-9050	BOTTLE, N/M, HDPE,15ML,STERILE	896	42,688
A312089-0008	BTL PKG HDPE;8OZ 250 ML==	250	18,495
A312087-0032	BTL PACKAGING PP; 32 OZ	50	10,645
A8050-0250	TBG 890 FEP; 3/16 X 1/4 50FT==	50	12,366
A6A 0010	40ml/48mmSPC NO LBL, NO CAP,NS	600	12,151
A5306-0130	VACUUM PLATE PC;13 IN	4	19,785
A4250-0075	FUNNEL ANALYTICAL PP;75MM	36	10,645
A12-0151	MIC PLATES, 100/CS]]	100	22,796

Cat No.	Description	Packing	Price Rs.
A342024-1000	STR PETG BTL W/CLOS,1000ML==	24	12,688
A342830-0110	CLOS, MPV, NO CODER, HDPE; 11MM, EBEAM	1000	21,398
A312097-0032	BTL,N/M,BULK,FLUOR,HDPE;32OZ==	50	19,677
A8050-0375	TBG 890 FEP; 5/16 X 3/8 50FT	50	19,570
A6A 0014	90ml/53mmSPC NO LBL, NO CAP,NS	300	7,312
A2115-1000	MASON JAR,PP;1000ML	24	18,404
A3662-0010	GRADUATED CYLINDR PP;10ML	24	20,430
A312006-0002	BTL BULK W/CLOS PP;2OZ NM60ML	1000	64,516
A13-001S	13x100 TT PS w/SCRW CAP BLU,ST	1000	43,226
A362150-1384	COLOR CLSR,PP,38-430,WHITE	250	7,634
A1201-0030	BEAKER PP GRADUATED; 30ML	48	10,319
A232702	AMPLIFICATION TAPE	100	11,183
A5305-0910	VACUUM CHAMBER PEI/PC;9X10	Each	17,527
A342020-0250	STER. PETG MEDIA BTL., 250ML]]	60	13,723
A362150-4384	COLOR CLSR,PP,38-430,GREEN	250	7,634
A2324-0008	AUTOCLAVABLE LOWBOY PP;8L	4	32,473
A112250	Cap, HDPE, Easy On/Off	250	36,022
A7135-0001	BIO-SAFE CAR PC;14.5X7XX6.75IN	4	19,462
A62080-00	VERSI-DRY; SA MAT, 18" X 20"]]	350	16,344
A2301-0020	CRBY W/TUB PP; 10L	6	35,957
A17-006S	17x100 Test TB w/clear Snap Cap ST	1000	40,215
A5A 0002	12mm SNAP CAP ONLY, NATURAL	10000	72,903
A312184-0002	BTL PKG WM TRANS AMBR HDPE;2OZ	1000	54,301
A6379-0004	SAFETY WASTE SYSTEM, 4L==	Each	6,702
A312187-0008	BTL PKG W/M PP;8OZ L/W250ML	250	24,194
A4465GRE	SepraSeal Capmat PrSpl, Grn, NS, 10/cs	10	7,419
A4465RED	SepraSeal Capmat PrSpl, Red, NS, 10/cs	10	7,419
A4465YEL	SepraSeal Capmat PrSpl, Ylw, NS, 10/cs	10	7,419
A312006-0004	BTL BLK W/CL PP;4OZ NM125ML	500	36,989
A4110-2000	FLASK BAFFLED PC;2000ML	4	9,681
A4466BLU	SepraSeal Capmat PrSpl, Blu, S, 10 /cs	10	8,065
A4466GRE	SepraSeal Capmat PrSpl, Grn, S, 10 /cs	10	8,065
A4466GRY	SepraSeal Capmat PrSpl, Gry, S, 10 /cs	10	8,065
A4466PUR	SepraSeal Capmat PrSpl, Pur, S, 10 /cs	10	8,065
A4466RED	SepraSeal Capmat PrSpl, Red, S, 10 /cs	10	8,065
A4466YEL	SepraSeal Capmat PrSpl, Ylw, S, 10 /cs	10	8,065
A2318-0010	CRBY W/SPGT LDPE;1GAL,4L	6	20,323
A362150-6384	COLOR CLSR,PP,38-430,BLUE	250	7,634
A6920-0060	WASTE CONTAINER LRG PP;6GAL	4	40,000
A312104-0032	BTL BULK W/CLOS HDPE; 32 OZ	50	13,011
A6A 0011	60ml/48mmSPC NO LBL, NO CAP,NS	500	10,860
A3120-2024	NALGENE BioBottle Sterile PP	24	76,383
A312089-0001	BTL PACKAGING HDPE;30ML NM==	1000	42,366
ADS3131-0038	CENT SLNGCP ASSY ETFE;38MM	2	1,935
A3663-0250	GRADUATED CYLINDR PMP;250ML	12	21,290
A312187-0002	BTL PKG W/M PP;2OZ L/W 60ML	1000	57,527
A4256-0414	FUNNEL UTILITY PP;4 1/4IN	144	32,796
A2117-0500	JAR STRT SIDE W/M PMP;500ML	16	11,720
A2118-0032	JAR STRTSIDE W/M PP;32OZ]]	24	12,366
A312088-0001	BTL PKG N/M BULK LDPE;1OZ L/W	1000	45,269
A312084-0008	BTL PKG TRANS AMBER HDPE; 8 OZ	250	20,860
A2089-0008	BOTTLE NM HDPE;250ML	72	5,591
A2752-9025	LAB DROP BTL, 8ML, WASST CLS	25	2,234
A5970-0425	RACK TT UNWIRE GREEN; 25MM	8	15,426
A3141-0250	CENT BTL W/SC PPCO; 250 ML	36	41,809
A2006-0004	BTL N/M PP;4OZ,125ML]]	72	6,489
A6250-9050	SAMPLE VIAL W/CLSR LDPE;50 ML	144	15,054
A4477BLU	ScrewCap Tray, Blue Caps	480	23,226

Cat No.	Description	Packing	Price Rs.
A17-003S	17x100 Test TB w/Blue Snap Cap ST	500	26,774
A3122-0250	CENT BTL PC;250ML	36	27,979
A362150-7384	COLOR CLSR,PP,38-430,AMBER	250	7,634
A5100-0050	CONTROL RATE FREEZER, 5.0ML	Each	5,319
A6917-0150	AUTOCLV BSKT PP;178X168X156 MM	6	7,957
A342044-0650	BTL,SQ,PET,650ML,W/OCLOS,STR]]	48	9,570
A1510-0600	BEAKER PFA; 600 ML	4	33,548
A6404	STRIP, 1X12, IMM 4, FB, 320/CS	320	17,634
A249944	V96 POLYPROP PLATE NAT NS==	120	28,511
A312087-0004	BTL PACKAGING NM;4OZ LW125ML	500	30,000
A4103-0500	FLASK ERLNMYR PC;500ML	12	12,581
A1001-0010	IMHOFF CONE RACK PMMA	4	40,753
A362150-4130	COLOR CLSR,PP,13-415,GREEN	2000	29,462
A6230-0500	HYDROMETER JAR PMP;500ML	6	7,849
A362805-0020	VIAL, MPV, PPCO; AMBER, 2.0ML	1000	11,828
A312006-0032	BTL BULK W/CLOS PP;32OZ NM 1L	50	12,796
A362150-0384	COLOR CLSR,PP,38-430,NAT==	250	7,634
A439225	MICROWELL TRAY 60 WELL W /LID	100	23,871
A3663-0100	GRADUATED CYLINDR PMP;100ML	12	16,344
A362004-9025	BTL W/OCLSR,AMBER HDPE,N/M,8ML	2000	55,161
A312018-0250	BOTTLE SQUARE HDPE;250 ML	250	45,591
A2195-0183	TORQUE FITTING, 83MM PP, 3/8" DRIVE	Each	25,213
A4106	Decapper Stand	1	13,548
A362002-9050	BTL W/O CLSR,HDPE,15ML,NAT	2000	52,043
A6356-0001	SFTY SPLASH SHIELD,PC,8.5X12IN	4	32,473
A260251	96 DEEPWELL PLATE PP 1ML ST]]	50	40,426
A362006-9050	PP BOTTLE W/O CLOS,1/2 OZ BULK	2000	54,086
A362085-0001	BTL W/OCLSR,AMB HDPE,N/M, 30ML	1000	37,419
A2202-0020	BTL LRG N/M LDPE;2GAL,8L]]	6	13,871
A322021-0030	SQ MEDIA BTL AMBER PETG;30ML	280	30,532
A374513	2.0mL Int Uncoded WP Grads Bulk	480	26,774
A312085-0008	BTL PKG N/M AMB HDPE;8OZ L/W]]	250	20,968
A312087-0016	BTL PACKAGING NM PP;16OZ LW50	125	16,667
A5242-0050	PIPET JAR XLPE;E	6	66,237
A312185-0002	BTL PACKAGING WM AMBER 2 OZ	1000	54,362
A312105-0032	BTL W/M W/C UN;32OZ,50/BOX	50	14,301
A2221-0010	JUG PP;1GAL,4L==	6	11,290
A2117-0250	JAR STRT SIDE W/M PMP;250ML	24	11,075
A2104-0001	BTL W/M HDPE;1OZ,30ML]]	72	5,106
A2016-1000	BOTTLE SQUARE PPCO; 1000 ML==	24	9,894
A2105-0001	BTL W/M PP;1OZ,30ML]]	72	5,426
A6A 0008	20ml/35mmSPC NO LBL, NO CAP,NS	1000	12,151
A62060-00	VERSI-DRY; SA ROLL,20" X 300]]	600	16,774
A362015-0500	BTL,SQ PC 500ML,TRAY W/O CL	40	14,731
A322002-9025	BTL PKG SW HDPE;1/4 OZ, 8 ML	1500	64,516
A6920-0120	WASTE CONTAINER LRG PP;12GAL	4	61,720
A312002-0032	BTL BULK W/CL HDPE;32OZ N/M]]	50	12,366
A5050-0001	STORAGE BOX PC; 51/4X51/4X2IN	24	19,677
A2117-0060	JAR STRT SIDE W/M PMP;60 ML	48	11,290
A362008-9025	BTL W/O CLSR,HDPE,8ML, WHITE	2000	55,806
A4250-0035	FUNNEL ANALYTICAL PP;35MM	36	5,914
A312103-0032	BTL BULK W/CLOS LDPE; 32 OZ	50	12,903
A4422	Square Cap Mat, Sterile 2.0ML	10	4,194
A2002-0002	BTL N/M HDPE;2OZ,60ML]]	72	4,946
A2016-0125	BOTTLE SQUARE PPCO; 125ML	72	10,426
A4150-2000	FLASK DEWAR HDPE;2L	2	46,809
ADS0397-0010	145 FUN ADP,BK	25	2,366
A37066-00	18RSI-DRY; LD ROLL, 20" X 300]]	600	12,903

Cat No.	Description	Packing	Price Rs.
A62065-00	VERSI-DRY; SA ROLL, 20"X 150"]	300	9,247
ADS2408-0250	WSHBTL WM RED UNTRY LDPE;250ML	4	1,935
A6370-0004	BENCH CONTAINER,BIOHAZ;PP 1.5G	Each	14,362
A342805-0020	VIAL, MVP, STERILE, PPCO; AMBER, 2.0ML	1000	12,903
ADS1511-3000	BEAKER W/HANDLE, PFA; 3000ML	Each	24,409
A2189-0008	BOTTLE WM HDPE;250ML]]	72	7,419
A2321-0020	CRBY RECT W/SPG PP; 2 GAL/9L	6	49,355
A4430-11	Round Cap Mat, Non-St 1.4ml/,75ml 100/cs	100	26,596
A2016-0030	BOTTLE SQUARE PPCO;30 ML	72	7,553
A1510-0100	BEAKER PFA; 100 ML	6	15,376
A322006-9025	BTL PKG SW PP; 1/4 OZ.	1500	68,495
A312018-0500	BOTTLE SQUARE HDPE;500 ML	125	31,398
A5920-0060	RACK PETRIDISH PC;100MM	2	17,234
A312087-0001	BTL PACKAGING NM PP;1OZ LW30ML	1000	53,011
A2118-9050	JAR STRT SIDE W/M PP;1/2 OZ.]]	72	7,419
A62050-00	VERSIDRY; SA DSP, 20" X 300"]	300	9,362
A4463GRE	SepraSeal CapMat, Grn, NS, 10 mats/ cs	10	6,667
A342040-0250	BTL,SQ,PET,250ML,W/CLOS,STER]]	60	11,613
A4463GRY	SepraSeal CapMat, Gray, NS, 10 mats/ cs	10	6,667
A4463PUR	SepraSeal CapMat, Purp, NS, 10 mats/ cs	10	6,667
A4463YEL	SepraSeal CapMat, Yelw, NS, 10 mats/ cs	10	6,667
A4463RED	SepraSeal CapMat, Red, NS, 10 mats/ cs	10	6,667
ADS6630-4000	STIR BAR FLOATING TFE/ETFE	2	33,333
A312189-0001	BTL PACKAGING WM HDPE 1 OZ	1000	49,032
A2097-0032	BTL,N/M,FLUOR,HDPE;32 OZ==	24	10,323
A5705-1010	STAINING BOX, 10X10CM	2	3,548
A2221-0020	JUG PP;2GAL,8L	6	17,957
A6379-0010	SAFETY WASTE SYSTEM, 10L	Each	9,362
A312750-9025	DROPPER BOTTLE, LDPE 8ML	2000	55,376
A4421	Square Cap Mat, Non-Sterile 2.0ML	10	3,548
A3663-0500	GRADUATED CYLINDR PMP;500ML	8	18,495
ADS2327-0020	FLUORO REC CRBY W/SPGT 9L	Each	9,140
A2107-0032	BTL W/M PMP;32OZ,1000ML	16	25,806
A715311-0010	STPCOCK ASSY PP	1	2,021
A2104-0032	BTL W/M HDPE;32OZ,1000ML]]	24	7,766
A2002-0016	BTL N/M HDPE;16OZ,500ML]]	48	8,602
A362800-0045	VIAL, MPV, PPCO; 4.5ML	1000	16,452
A2126-4000	BTL,HEAVY DUTY PP;4000 ML]]	6	21,489
A362002-0002	BTL W/O CLSR,HDPE,60ML,NAT	1000	61,398
A2015-2000	BOTTLE SQUARE PC;2000ML]]	6	11,170
A4301-0500	FUNNEL SEPARATORY FEP;500ML	4	40,430
A362821-1111	CLOS, MPV, LOW PRO, AMBER PPCO; 11MM	1000	8,387
A362821-1112	CLOS, MPV, LOW PRO, PINK PPCO; 11MM	1000	8,387
A2110-0008	BTL W/M SQR PP; 8 OZ. 250 ML	72	18,511
A2318-0065	CRBY W/SPG LDPE;61/2GAL,25L==	1	9,462
A312087-0008	BTL PACKAGING NM PP;8OZ LW250	250	23,333
A312084-0001	BTL PKG TRANS AMBER HDPE;1 OZ	1000	48,817
A362004-9050	BTL W/O CLSR,AMBER HDPE, 15ML	2000	56,882
A2411-0030	DROP DISP BTL LDPE;30ML N/M	72	14,086
A710315-0004	GASKET	6	3,011
A2006-0002	BTL N/M PP;2OZ,60ML==	72	5,484
A312751-9025	DROPPER BTL, LDPE, WHITE, 8ML	2000	57,097
A267460	384PP SW STD HT NAT STR 100/CS	100	101,075
A342040-0125	BTL,SQ,PET,125ML W/CLOS, STER]]	96	13,656
A312750-9050	DROPPER BOTTLE, LDPE, 15ML	2000	64,624
A312002-9025	BTL BULK W/CLOS HDPE; 1/4 OZ	2000	74,946
A2197-0016	BTL,W/M,FLUOR,HDPE;16 OZ	48	16,237
A2204-0020	BTL AMBR LARG PP;2 GAL, 8L	6	16,989

Cat No.	Description	Packing	Price Rs.
A4465GRY	SepraSeal Capmat PrSpl, Gry, NS, 10/cs	10	7,527
A4465PUR	SepraSeal Capmat PrSpl, Pur, NS, 10/cs	10	7,527
A4465BLU	SepraSeal Capmat PrSpl, Blu, NS, 10/cs	10	7,527
A7131-0001	LAB CARRIER HDPE;15X14X10.5	2	10,968
A6132-0010	REPR HANDPUMPW/GAGE PVC; 15CC	4	40,215
A2007-0008	BTL RECT HDPE;8OZ,250ML]]	72	11,290
A7705	PLATE, 96W, MF1,WHITE,FB,50/CS	50	16,774
A336088	Blue Internal Thread Cap	2500	24,681
A1010-0507	SETTLOMETER KIT PC	4	37,419
A336092	Yellow Internal Thread Cap	2500	30,638
A6302	STRIP, 1X12, IMM 2, FB, 320/CS	320	16,237
A2324-0015	AUTOCLAVABLE LOWBOY PP;15L	4	37,742
A6803-0001	RACK/STAND, PIPET	Each	9,140
A336081	Red Internal Thread Cap	2500	25,319
A312085-0001	BTL PKG N/M AMBER HDPE;1 OZ LW	1000	48,817
A312006-0001	BTL BULK W/CLOS PP;1 OZ NM30ML	1000	55,269
A312751-9050	DROPPER BTL, WHITE, LDPE, 15ML	2000	66,237
A2220-0010	JUG LDPE;1GAL,4L	6	11,720
A7905	PLATE, 96W, MF2,WHITE,UB,50/CS	50	20,215
A322004-9025	BTL PKG SW AMB HDPE;1/4OZ,8ML	1500	70,538
A253624	LOW BOT LID UNIVERSAL STERILE	100	32,258
A312002-0004	BTL BULK W/CL HDPE; NM125ML	500	37,849
A2114-0002	BTL W/M SQR HDPE; 2OZ. 60ML==	72	6,989
A5352-0002	JAR W/COVER PP;2.25 QT.	6	15,269
A2197-0008	BTL,W/M,FLUOR,HDPE;8 OZ	72	17,634
A312104-0008	BTL BULK W/CLOS HDPE; 8 OZ	250	30,430
A2195-6177	TORQUE WRENCH, 3/8" DRIVE; 0-75 IN-LB	Each	36,064
A5352-0004	JAR W/COVER PP;4.88 QT.	6	16,882
A362150-5130	COLOR CLSR,PP,13-415,RED	2000	29,570
A312006-9025	BTL BULK W/CLOS PP;1/4OZ 8 ML	2000	78,710
A312103-0016	BTL BULK W/CLOS LDPE; 16 OZ	125	24,194
A2003-0016	BTL N/M LDPE;16OZ,500ML==	48	8,710
A6A 0013	120ml/53mmSPC NO LBL,NO CAP,NS	300	9,677
A312184-0001	BTL PKG WM TRANS AMBR HDPE;1OZ	1000	53,548
A312106-0032	BTL BP WCL AMBR HDPE;32OZ W/M	50	15,054
A6311-0010	MARKER,LAB,BLK]]	12	3,333
A5116-1300	LABTOP COOLR,TT,0 DEG,13MM,PC	Each	10,000
A362150-7130	COLOR CLSR,PP,13-415,AMBER	2000	29,570
A5935-0016	RACK TT SLANT PC;16MM	4	18,602
A362150-6130	COLOR CLSR,PP,13-415,BLUE	2000	29,570
A362150-1130	COLOR CLSR,PP,13-415,WHITE	2000	29,570
A362150-0130	COLOR CLSR,PP,13-415,NAT	2000	29,570
A322002-9050	BTL PKG SW HDPE;1/2 OZ, 15 ML	1500	67,097
A1000-0010	IMHOFF SET CONE PC;1000ML==	4	8,710
A3220	Database Software, VisionTrack, 1EA	Each	162,903
A312103-0008	BTL BULK W/CLOS LDPE; 8 OZ	250	31,075
A2117-0125	JAR STRT SIDE W/M PMP;125ML	24	9,570
A2203-0005	BTL LRG N/M PP;1/2GAL,2L==	6	7,527
A460372	384 WELL,WHITE,MAXISORP	30	28,617
A2003-9025	BTL N/M LDPE; 1/4 OZ, 8ML	72	3,333
A5977-0313	RACK TT PEG BLUE PP;13MM	8	6,989
A2189-0002	BOTTLE WM HDPE;60ML]]	72	4,624
A1510-0050	BEAKER PFA; 50 ML	6	13,226
A2099-0002	BTL,IP2,N/M,HDPE; 2 OZ	72	5,484
A7605	PLATE, 96W, MF1,BLACK,FB,50/CS	50	16,774
A6700-1812	BENCHTOP BETA SHIELD,12X18	Each	12,766
A2118-0016	JAR STRTSIDE W/M PP;16OZ]]	24	8,511
A312099-0002	BTL,IP2,N/M,BULK,HDPE; 2 OZ	1000	72,903

Cat No.	Description	Packing	Price Rs.
A1510-1000	BEAKER PFA; 1000ML	4	50,108
A3120-0500	CENT BTL PPCO;500ML	24	15,484
A16-002S	16x125 TB clear Screw Cap PSST	1000	58,710
A6250-9075	SAMPLE VIAL W/CLSR LDPE;75 ML	144	19,462
A362008-9050	BTL W/O CLSR,HDPE,15ML,WHITE	2000	60,108
A74240-00	VERSI-DRY; SUPER, 20"X 40"]]	50	16,022
A8000-1065	TBG-180-VAC 1/4X5/8X3/16 10FT	10	3,871
A312002-0002	BTL BULK W/CL HDPE;N/M60ML	1000	74,516
A4256-0234	FUNNEL UTILITY PP;2 3/4IN	288	53,011
A3140-1006	Centrifuge Bottle SC PC 1000mL	6	40,430
ADS6630-1000	STIR BAR FLOATING TFE/ETFE	2	29,355
A2114-0016	BTL W/M SQR HDPE;16OZ. 500ML==	48	13,333
A2125-2000	BTL HEAVY DUTY HDPE;2000ML]]	12	13,118
A322006-9050	BTL PKG SW PP;1/2 OZ.	1500	70,323
A312106-0008	BTL BP WCL AMBR HDPE;8OZ WM25	250	35,161
A4490	Duraseal, Bulk, 500 Ct.	500	7,021
A5977-0013	RACK TT PEG WHITE PP;13MM	8	6,989
A4280-0700	FUNNEL BUCHNER PP;70MM	6	4,946
A2124-0005	FLUORO W/M 2L HDPE BTL w/CLSR==	6	7,634
A232701	SEALING TAPE==	100	10,638
A6917-0127	AUTOCLV BSKT PP;154X123X105 MM	6	7,097
A2411-0060	DROP DISP BTL LDPE;60ML N/M	48	11,075
A312104-0016	BTL BULK W/CLOS HDPE; 16 OZ	125	25,054
ADS1511-1000	BEAKER W/HANDLE, PFA; 1000ML	Each	17,634
A5935-0020	RACK TT SLANT PC;20MM	4	18,710
A312185-0016	BTL PACKAGING WM AMBER 16 OZ.	125	16,702
A342020-2000	STER PETG MEDIA BTL.; 2000ML]]	12	15,851
A5317-0180	DESCTR CAB ACRY;12X12X18 IN.	Each	46,702
A2204-0005	BTL AMBR LARGE PP;1/2 GAL, 2L	6	7,849
A2016-0060	BOTTLE SQUARE PPCO; 60 ML	72	7,660
A5832-0001	DRAWER, STACKABLE, 4X9X9, ACR	Each	9,355
A5311-0250	DESICTR TRANSPARENT PC;250MM	4	29,468
A312185-0032	BTL PACKAGING WM AMBER 32OZ]]	50	10,957
A312016-0060	BOTTLE SQUARE PP;60 ML	1000	114,086
A2003-0002	BTL N/M LDPE;2OZ,60ML	72	5,161
A2018-1000	BOTTLE SQUARE HDPE;1000ML	24	8,925
AAB0724	384 Well PCR Plate Carrier	Each	14,301
A6745-0010	LARGE BETA WASTE SHLD ACRY;10L	Each	36,809
A3655	PLATE, 96W, IMM 2, UB, 50/CS]]	50	15,591
ADS0345-0001	MANIFOLD,VACUUM,SS,3 PLACE	Each	105,914
A312002-0008	BTL BULK W/CL HDPE;8OZ NM250ML	250	28,172
A312007-0008	BTL RECT W/CLOS HDPE; 8 OZ	250	41,183
A2015-0250	BOTTLE SQUARE PC;250 ML	48	21,064
ADS0396-0080	STOPPER,RUBBER,#8,W/5/8IN HOLE	3	2,043
A312084-9025	BTL PKG TRANS AMBER HDPE;1/4OZ	2000	83,871
A3120-2006	Centrifuge Btl SC PPCO 2000mL	6	19,043
AAB1797	Clear Seal Thin, Polymer 85x135	100	26,989
A5976-0016	RACK TT UNWIRE WHITE PP;16MM	8	10,108
A312002-9050	BTL BK WCL HDPE;1/2OZ NM15ML==	2000	78,602
A8000-9010	TBG-180-PVC 1/8X3/16X1/32 250F	250	6,344
A2125-4000	BTL HEAVY DUTY HDPE;4000ML]]	6	13,871
A06 0181	20ml/35mmSPC NO LBL, WH CAP,NS	1000	29,677
A2006-9125	BOTTLE, N/M, PP, 1/8 OZ, 4 ML==	72	4,516
A3662-2000	GRADUATED CYLINDR PP;2000ML	4	18,511
A312003-0016	BTL BULK WCL LDPE;16OZ NM500ML	125	24,194
A8005-0130	TBG-980-PVC 3/8X9/16X3/32 50FT	50	8,602
A5250-0050	PIPET CLEANING SET;E	Each	39,355
A8000-9020	TBG-180-PVC 1/8X1/4X1/16 250FT	250	10,323

Cat No.	Description	Packing	Price Rs.
A2015-1000	BOTTLE SQUARE PC;1000ML==	24	22,258
A312105-0002	BTL BULK W/CLOS PP; 2 OZ	1000	71,398
A2016-0250	BOTTLE SQUARE PPCO; 250 ML	72	16,237
A30 3500	3500ML 24 HR URINE CONTAINER	24	11,935
A3663-2000	GRADUATED CYLINDR PMP;2000ML	4	19,570
A2110-0002	BTL W/M SQR PP;2 OZ. 60ML	72	8,172
A4280-0550	FUNNEL BUCHNER PP;55MM	8	5,161
A322004-9050	BTL PKG SW AMB HDPE;1/2OZ,15ML	1500	73,656
A5970-0125	RACK TT UNWIRE ORANGE; 25MM	8	15,484
A2114-0032	BTL W/M SQR HDPE;32OZ.1000ML==	24	10,108
A8030-0120	TBG-280-PUR 3/8X1/2X1/16 50FT	50	9,140
A2002-0001	BTL N/M HDPE;1OZ,30ML]]	72	4,409
A4256-0638	FUNNEL UTILITY HDPE;6 3/8IN	72	57,742
A5970-0525	RACK TT UNWIRE RED; 25MM	8	15,161
A312099-0016	BTL IP2 N/M BULK HDPE;16 OZ	125	24,194
A3663-0010	GRADUATED CYLINDR PMP;10ML	24	21,828
A312006-9050	BTL BULK W/CLOS PP;1/2OZ 15ML	2000	82,688
A312104-0004	BTL BULK W/CLOS HDPE; 4 OZ	500	47,419
A342178-0240	SEPTUM CLOSURE 24MM STERILE	200	30,323
A3662-0250	GRADUATED CYLINDR PPCO; 250ML	12	19,677
A4420	Square Cap Mat, 2ml Bulk100/case	100	27,312
A3455	PLATE, 96W, IMM 2, FB, 50/CS]]	50	15,426
A312003-0002	BTL BULK W/CL LDPE;2OZ N/M60ML	1000	73,118
A312004-9025	BTL BULK W/CL AMBER HDPE;1/4OZ	2000	85,269
A312103-0004	BTL BULK W/CLOS LDPE; 4 OZ	500	48,495
A312187-0001	BTL PACKAGING W/M PP;1 OZ.	1000	57,097
A4260-0060	FUNNEL HEAVY-DUTY LDPE;6IN	12	16,667
A7805	PLATE, 96W, MF2,BLK,FB,50/CS]]	50	20,323
AN411-0250	Nalgene 250ml Natural WM Bottle Certified, sterile	60	32,234
A8000-1270	TBG-180-VAC 5/8X1-3/8X3/8 10FT	10	13,978
A312002-0016	BTL BLK W/CL HDPE;16OZ NM500==	125	24,409
A5310-0250	DESICTR VAC PP-PC;250MM	4	31,398
A6132-3000	Repair Kit for New Style30cc PVC Pumps	4	16,452
A8000-0030	TBG-180-PVC 3/16X5/16X1/16	50	3,656
A312004-0032	BTL BULK W/CL AMBER HDPE;32 OZ	50	15,269
A312002-0001	BTL BULK W/CL HDPE;1OZ N/M30ML	1000	53,978
A267462	384 PP SW STD HT WHITE 25/100	100	104,731
A5-001	0.5ML SAMPLE CUP	10000	61,720
A8001-0102	TBG-180-MET 1.0X2.0X0.50 25M	25	2,258
A74000-00	VERSI-DRY;SPR ROLL,20"X250'==	250	9,681
A362002-0016	BTL W/O CLSR,HDPE,500ML,NAT	125	22,903
A2003-0032	BTL N/M LDPE;32OZ,1000ML==	24	7,419
A312103-0001	BTL BULK W/CLOS LDPE; 1 OZ	1000	57,419
A2002-0004	BTL N/M HDPE;4OZ,125ML]]	72	6,344
A312006-9125	BTL BULK W/CL PP;1/8 OZ 3.8ML	2000	76,022
A4431	Round Cap Mat, Non-Sterile 1.4/.75ML	10	3,085
A8030-0060	TBG-280-PUR 1/4X3/8X1/16 50FT	50	6,882
A5929-0016	RACK TT PC;16MM	4	18,817
A312104-0001	BTL BULK W/CLOS HDPE; 1 OZ	1000	57,849
A312104-0002	BTL BULK W/CLOS HDPE; 2 OZ	1000	69,462
A2002-0032	BTL N/M HDPE;32OZ,1000ML]]	24	7,419
A312103-0002	BTL BULK W/CLOS LDPE; 2 OZ	1000	73,118
A1201-0400	BEAKER PP GRADUATED; 400ML	36	16,915
A2189-0032	BOTTLE WM HDPE;1000ML]]	24	6,559
A8000-1375	TBG-180-VAC 1X2X1/2 10FT	10	28,925
A2003-0004	BTL N/M LDPE;4OZ,125ML==	72	6,559
A2205-0016	LARGE N/M BOTTLE, PC; 500 ML	24	11,398
A342020-0125	STER. PETG MEDIA BTL., 125ML]]	96	14,043

Cat No.	Description	Packing	Price Rs.
A15-001	15ml CENTRIFUG TB PS,NS no cap	1000	19,677
ADS5320-0910	VACUUM JAR PEI;9X10	Each	16,667
A2322-0050	CRBY RECT W/SPGT PC; 5GAL/20L	4	58,280
A1223-3000	BEAKER W/HANDLE PMP;3L	6	20,323
A276014	ALUMINUM SEALING TAPE==	100	11,935
A2118-0008	JAR STRTSIDE W/M PP;8OZ]]	36	8,511
A5A 0016	16mm HOLLOW CAP ONLY, NATURAL	10000	91,720
A2416-0125	DROPPER BTL LDPE;125ML N/M	48	22,796
A312185-0004	BTL PACKAGING WM AMBER 4 OZ.==	500	30,000
A342089-0001	BOTTLE, N/M, HDPE,30ML, STERILE	864	49,255
A4260-0040	FUNNEL HEAVY-DUTY LDPE;4IN	12	11,075
A312084-9050	BTL PKG TRANS AMBER HDPE;1/2OZ	2000	87,097
A2110-0006	BTL W/M SQR PP;6 OZ. 175 ML	72	13,011
A312105-0004	BTL BULK W/CLOS. PP;4 OZ.	500	55,591
ADS2205-0020	BTL LARGE N/M PC;8L==	Each	5,699
A713120-0063	2L BioBottle 2-Piece Repl. Clos w/Gasket	2	2,151
A8050-0125	TBG 890 FEP; 1/16X1/8 50FT	50	5,638
A8005-0190	TBG-980-PVC 1/2X3/4X1/8 50FT	50	11,290
A322002-9125	BTL SW HDPE;1/8 OZ. 13MM	1328	57,312
A4252-0080	FUNNEL POWDER PP;80MM	36	8,817
A312105-0008	BTL BULK W/CLOS PP; 8 OZ	250	36,452
A5976-0516	RACK TT UNWIRE RED PP;16MM	8	10,108
A322006-9125	SHRINK-WRAPPED PP BOTTLE;1/8OZ	1328	60,430
ADS2085-0016	BOTTLE AMBER NM HDPE;500ML	48	9,892
A2103-0032	BTL W/M LDPE;32OZ,1000ML]]	24	7,634
A2015-0030	BOTTLE SQUARE PC;30 ML	96	20,538
A2002-0008	BTL N/M HDPE;8OZ,250ML]]	72	9,140
A8000-0180	TBG-180-PVC 1/2X5/8X1/16 50FT	50	7,634
A3662-1000	GRADUATED CYLINDR PPCO; 1000M==	6	16,489
A312114-0002	BTL BULK W/CLOS SQ HDPE; 2OZ	1000	111,720
A5929-0020	RACK TT PC;20MM	4	18,817
A4423	SuperSealer Tape Mat	1	2,258
A7130-0010	UTILITY CARRIER HDPE	6	10,108
A4108-0500	FLASK ERL SCRW CLS PC;500ML	12	15,699
A312105-0001	BTL BULK W/CLOS PP; 1 OZ	1000	60,323
A312099-0004	BTL IP2 N/M BULK HDPE;4 OZ	500	48,065
A8000-4060	TBG-180-PVC 1/4X3/8/1/16 100FT	100	6,774
A2114-0006	BTL W/M SQR HDPE; 6OZ. 175ML==	72	12,688
A6301	STRIP, 1X12, IMM 1, FB, 320/CS	320	14,681
A2120-0005	BTL LRG W/M HDPE;1/2GAL,2L]]	6	5,851
A5970-0016	RACK TT UNWIRE WHITE; 16MM==	8	14,149
A30 3000L	3000ML 24 HR URINE CONTAINER	40	17,097
A5976-0416	RACK TT UNWIRE GREEN PP;16MM	8	10,108
A3663-0050	GRADUATED CYLINDR PMP;50ML	18	20,860
A5970-0325	RACK TT UNWIRE BLUE PK; 25MM	8	15,376
A3663-0025	GRADUATED CYLINDR PMP;25ML	18	19,140
A2099-0004	BTL IP2 N/M HDPE;125ML,4OZ	72	7,204
A312016-0030	BOTTLE SQUARE PP;30ML	1000	111,613
A8000-0090	TBG-180-PVC 5/16X7/16X1/16 50F	50	5,376
A5115-0012	LABTOP COOLER,-20 DEG C,PC;12]]	Each	8,298
A2104-0016	BTL W/M HDPE;16OZ,500ML]]	48	11,915
ADS0395-0708	GASKET,VACUUM TYPE,7/8	6	2,796
A362821-0110	CLOS, MPV, LOW PRO, PPCO; 11MM	1000	8,065
ADS3124-0010	CENT SPRT,BTL RND PC;61.7MM	4	3,404
A5970-0213	RACK TT UNWIRE YELLOW; 13MM	8	14,149
A8005-0100	TBG-980-PVC 5/16X1/2X3/32 50FT	50	8,387
A2103-0008	BTL W/M LDPE;8OZ,250ML==	72	10,753
A3673-0008	PHARM GRAD PMP;8OZ,250ML	12	18,280

Cat No.	Description	Packing	Price Rs.
A5929-0030	RACK TT PC;30MM	4	18,817
A5115-0032	LABTOP COOLER,-20DEG C,PC;32]]	Each	16,170
A5976-0316	RACK TT UNWIRE BLUE PP;16MM	8	10,108
A8000-0310	TBG-180-PVC 3/4X1X1/8 50FT	50	18,495
A5970-0120	RACK TT UNWIRE ORANGE; 20MM	8	13,871
A2003-0008	BTL N/M LDPE;8OZ,250ML	72	9,247
A2002-9025	BTL N/M HDPE; 1/4 OZ, 8ML]]	72	3,441
A312105-0016	BTL BULK W/CLOS PP; 16 OZ	125	30,968
A8000-1350	TBG-180-PVC 1X1-1/4X1/8 50FT	50	26,129
A8000-0350	TBG-180-PVC 1X1-1/4X1/8 50FT	50	23,118
A3123-0250	CENT BTL RND PC;250ML	36	38,723
A342044-1000	BTL,SQ,PET,1000ML,W/OCLO,STER]]	24	9,140
A3120-0250	CENT BTL PPCO;250ML==	36	19,468
A2103-0001	BTL W/M LDPE;1OZ,30ML==	72	5,054
A312004-0001	BTL BULK W/CL AMBER HDPE;1 OZ	1000	59,247
A312006-0008	BTL BULK W/CLOS PP;8OZ NM250ML	250	33,011
A5970-0220	RACK TT UNWIRE YELLOW; 20MM	8	14,086
A8076	Lid, Reagent Reservoir 8075	1	2,447
A5970-0020	RACK TT UNWIRE WHITE;20MM	8	14,301
A362800-0020	VIAL, MICRO, PPCO; 2ML]]	1000	11,075
ADS2085-0001	BOTTLE AMBER NM HDPE;30ML	72	5,851
ADS3132-0063	CENT. SEALING CAP PP;63MM	2	1,613
A312114-0006	BTL BULK W/CL SQ HDPE; 6 OZ	250	45,269
A312004-9050	BTL AMBR N/M HDPE;1/2OZ.15 ML	2000	91,935
ADS3147-0050	CONICL OAK RIDGE TB ADPTR;35ML	6	2,151
A6250-9028	SAMPLE VIAL W/CLSR LDPE;28 ML==	144	12,903
A2104-0008	BTL W/M HDPE;8OZ,250ML]]	72	11,075
ADS5996-0871	MULTI BTL RACK PC; 8 PLACE	Each	4,301
A5970-0216	RACK TT UNWIRE YELLOW; 16MM	8	14,086
A2016-0500	BOTTLE SQUARE PPCO; 500 ML]]	48	15,376
A7572	PLATE, 96W, ML 2+, FB, 50/CS]]	50	19,681
A5970-0116	RACK TT UNWIRE ORANGE; 16MM	8	14,086
A8005-0040	TBG-980-PVC 3/16X3/8X3/32 50FT	50	7,312
A362008-0002	BTL W/O CLSR,HDPE,60ML,WHITE	1000	73,763
A362821-0115	CLOS, MPV, LOW PRO, RED PPCO; 11MM	1000	8,495
A5970-0030	RACK TT UNWIRE WHITE; 30MM	8	15,484
A2009-0004	BTL AMBR RCT HDPE;4OZ,125ML	72	12,581
A4103-0125	FLASK ERLNMYR PC;125ML	24	12,447
A8000-0190	TBG-180-PVC 1/2X11/16X3/32 50F	50	10,538
A362821-0114	CLOS, MPV, LOW PRO, GREEN PPCO; 11MM	1000	8,495
A5970-0520	RACK TT UNWIRE RED; 20MM	8	14,086
A362821-0118	CLOS, MPV, LOW PRO, PURPLE PPCO; 11MM	1000	8,495
A2401-1000	WASH BTL ECON LDPE;1000 ML]]	12	4,043
A312110-0006	BTL WM SQR PP; 6 OZ. 175ML	250	47,312
A312084-9125	BTL N/M TRANS AMBER HDPE;1/8OZ	2000	81,075
A362821-0116	CLOS, MPV, LOW PRO, BLUE PPCO; 11MM	1000	8,495
A8000-0120	TBG-180-PVC 3/8X1/2X1/16 50FT	50	6,129
A3673-0032	PHARM GRAD PMP;32OZ,1000ML	6	17,419
A362821-0111	CLOS, MPV, LOW PRO, WHITE PPCO; 11MM	1000	8,495
A3673-0004	PHARM GRAD PMP;4OZ,125ML	12	14,516
A312016-0250	BOTTLE SQUARE PP;250 ML	250	60,323
A1203-2000	BEAKER PMP GRADUATED; 2000ML	4	10,430
A2411-0125	DROP DISP BTL LDPE;125ML N/M	48	13,548
A2110-0032	BTL W/M SQR PP;32 OZ. 1000ML==	24	12,366
A74218-00	VERSI-DRY;SUPERMAT, 18" X 20"]]	100	16,129
A3673-0016	PHARM GRAD PMP;16OZ,500ML	8	17,849
A322004-9125	BTL SW AMBER HDPE;1/8OZ. 13MM	1328	63,011
A6820-0010	PNEUMATIC TROUGH PP	6	9,247

Cat No.	Description	Packing	Price Rs.
A8000-9030	TBG-180-PVC 3/16X5/16X1/16 250	250	14,409
A2103-0002	BTL W/M LDPE;2OZ,60ML]]	72	6,022
A2110-0016	BTL W/M SQR PP; 16 OZ. 500ML	48	17,097
A5970-0230	RACK TT UNWIRE YELLOW ; 30MM	8	15,591
A5970-0130	RACK TT UNWIRE ORANGE; 30MM	8	15,591
A2-003	2ML HITACHI CUP	5000	43,441
A1203-4000	BEAKER PMP GRADUATED; 4000ML	4	14,839
A362821-0112	CLOS, MPV, LOW PRO, YELLOW PPCO; 11MM	1000	8,710
A5970-0516	RACK TT UNWIRE RED ; 16MM]]	8	14,194
A6370-0005	CONTAINER, BIOHAZ, PP; 5 GAL	Each	15,426
A342821-0110	CLOS, MPV, LOW PRO, STERILE, PPCO; 11MM	1000	9,032
A312009-0004	BTL RECT W/CL AMBR HDPE;4 OZ	500	88,602
A2103-0004	BTL W/M LDPE;4OZ,125ML]]	72	8,280
A7120-0020	PAN HDPE; 15 QT	6	18,710
A8000-0160	TBG-180-PVC 7/16X5/8X3/32 50FT	50	9,032
A312003-0004	BTL BULK W/CL LDPE;4OZ NM125ML	500	49,247
A312099-0032	BTL IP2 N/M BULK HDPE;32OZ]]	50	17,312
A6370-0015	CONTAINER, BIOHAZ, PP; 15GAL	Each	22,340
A362006-9125	PP BOTTLE W/O CLOS, 1/8 OZ BULK	2000	51,398
A3662-0050	GRADUATED CYLINDR PP;50ML	18	19,570
A362008-0016	BTL W/O CLSR,HDPE,500ML,WHITE	125	26,559
A5970-0420	RACK TT UNWIRE GREEN; 20MM	8	14,194
A312114-0016	BTL BULK W/CLSR SQ HDPE;16OZ	125	43,118
A5970-0530	RACK TT UNWIRE RED; 30MM	8	15,484
A8000-1325	TBG-180-VAC 3/4X1-1/2X3/8 10FT	10	16,559
A3741-BR	Mtx 1.0 mL, 2D, V-Btm w/ Cap, BC Rack	480	42,872
A8000-5120	TBG-180-PVC 3/8X1/2X1/16 500FT	500	46,667
A2035-0020	PETG BTL W/LINED CLSR,20ML,STR	100	12,447
A382099-0500	BTL,LOW PARTIC. N/M, HDPE 16OZ	48	13,656
ADS3132-0020	CENT SEALING CAP PP;20MM	2	1,183
A8000-0130	TBG-180-PVC 3/8X9/16X3/32 50FT	50	8,065
A322020-0500	BTL MEDIA BULK PETG;500 ML	40	10,106
A2099-0032	BTL IP2 N/M HDPE;1000ML,32OZ]]	24	8,602
ADS2408-0500	WSHBTL WM RED UNTRY LDPE;500ML	4	3,226
A2104-0048	BTL W/M HDPE; 48OZ, 1500ML	24	12,128
A5976-0013	RACK TT UNWIRE WHITE PP;13MM	8	10,215
A312004-9125	BTL BULK W/CL AMBER HDPE;1/8OZ	2000	84,301
A312016-0500	BOTTLE SQUARE PP;500 ML	125	41,828
A2-002	ANALYZER CUP 2.0ML PS	10000	44,839
A2006-0008	BTL N/M PP;8OZ,250ML]]	72	10,538
A5970-0416	RACK TT UNWIRE GREEN; 16MM==	8	14,194
A4262-0080	FUNNEL LARGE HDPE;8IN	6	7,527
A6169-0010	STIRRING ROD PP;	72	13,011
ADS2085-0032	BOTTLE AMBER NM HDPE;1000ML	24	8,602
A382099-0125	BTL,LOW PARTIC.,N/M, HDPE, 4OZ	72	10,108
A5972-0016	HLF RACK TT UNWRE WHT;16MM	8	10,645
A362015-0250	BTL,SQ PC 250ML,TRAY W/O CL	60	18,495
A2322-0020	CRBY RECT W/SPGT PC; 2GAL/9L	6	70,215
A342002-9025	BOTTLE, NM, HDPE, 8ML, STERILE	980	43,617
A264263	GENUNC STORAGE VIAL BOX	1	14,787
A2116-0500	JAR STRT SIDE W/M PC; 500 ML	16	12,366
A312003-0032	BTL BULK W/CL LDPE;32OZ N/M 1L	50	17,742
A6355-0001	FACE SHIELD PC	4	28,936
A312110-0032	BTL WM SWR PP; 32 OZ. 1000ML	50	27,312
A5970-0320	RACK TT UNWIRE BLUE; 20MM	8	14,194
A2116-0125	JAR STRT SIDE W/M PC; 125 ML]]	24	9,677
A3122-0500	CENT BTL PC;500ML	24	29,785
A5305-0609	VACUUM CHAMBER PC;6X9	2	17,419

Cat No.	Description	Packing	Price Rs.
A342040-1000	BTL,SQ,PET,1000ML,W/CLS,STER]]	24	11,720
A322020-0125	BTL MEDIA BULK PETG;125 ML]]	96	12,979
A312110-0016	BTL WM SQR PP; 16 OZ. 500ML	125	46,559
A312114-0032	BTL BULK W/CL SQ HDPE; 32 OZ	50	25,806
A312099-0008	BTL IP2 N/M BULK HDPE;8 OZ	250	34,409
A5977-0017	RACK TT PEG WHITE PP;17MM	8	7,957
A8005-0070	TBG-980-PVC 1/4X7/16X3/32 50FT	50	8,065
A5977-0317	RACK TT PEG BLUE PP;17MM	8	8,065
A342821-0115	CLOS, MPV, LOW PRO, RED, PPCO; 11MM	1000	9,462
A342821-0112	CLOS,MPV, LOW PRO, YELLOW, PPCO; 11MM	1000	9,462
A342821-1111	CLOS, MPV, LOW PRO, AMBER, PPCO; 11MM	1000	9,462
ADS2176-0384	CLSR POUR SPOUT PP;38-430	6	6,022
A312003-0008	BTL BULK W/CL LDPE;8OZ NM250ML	250	34,409
A2105-0002	BTL W/M PP;2OZ,60ML]]	72	6,452
A342821-0114	CLOS, MPV, LOW PRO, GREEN, PPCO; 11MM	1000	9,462
A362002-0032	BTL W/O CLSR,HDPE,1000ML,NAT	50	16,882
A5970-0430	RACK TT UNWIRE GREEN; 30MM	8	15,699
A312018-1000	BOTTLE SQUARE HDPE;1000 ML	50	23,548
A342821-0111	CLOS,MPV,LOW PRO,STERILE,WHITE,PPCO;11MM	1000	9,462
A362002-0008	BTL W/O CLSR,HDPE,250ML,NAT	250	31,935
A8000-0110	TBG-180-PVC 5/16X9/16X1/8 50FT	50	9,785
A5970-0316	RACK TT UNWIRE BLUE; 16MM==	8	14,194
A362015-0125	BTL,SQ PC 125ML,TRAY W/O CL]]	96	23,548
A8005-0260	TBG-980-PVC 5/8X7/8X1/8 50FT	50	17,312
A8000-5060	TBG-180-PVC 1/4X3/8X1/16 500FT	500	35,161
A4465	CapMat, SepraSeal Preslit	10	5,851
ADS2085-0002	BOTTLE AMBER NM HDPE;60ML	72	6,344
A312007-0032	BTL RECT W/CLOS HDPE; 32 OZ	50	30,000
A362002-0004	BTL W/O CLSR,HDPE,125ML,NAT	500	44,086
A2007-0032	BTL RECT HDPE;32OZ,1000ML==	24	14,301
A2099-0001	BTL,IP2,N/M,HDPE;1 OZ	72	5,484
A2197-0032	BTL,W/M,FLUOR,HDPE;32 OZ	24	14,946
A6283-1250	CLEAN SHEETS XLPE;12INX50FT	2	16,989
A342821-0118	CLOS, MPV, LOW PRO, PURPLE, PPCO; 11MM	1000	9,462
A8000-0370	TBG-180-PVC 1X1-3/8X3/16 50FT	50	36,774
A342821-0116	CLOS, MPV, LOW PRO, BLUE, PPCO; 11MM	1000	9,462
A8000-0100	TBG-180-PVC 5/16X1/2X3/32 50FT	50	7,849
A2015-0060	BOTTLE SQUARE PC;60 ML	96	27,957
A5972-0030	HLF RACK TT UNWRE WHT;30MM	8	11,075
A5972-0025	HLF RACK TT UNWRE WHT; 25MM	8	11,075
A2006-9025	BTL N/M PP; 1/4 OZ, 8ML==	72	4,516
A5970-0330	RACK TT UNWIRE BLUE; 30MM==	8	15,591
A342020-0030	PETG MEDIA BOTTLE STR 30ML==	280	32,128
A2189-0004	BOTTLE WM HDPE;125M]]	72	5,106
A8000-0060	TBG-180-PVC 1/4X3/8/1/16 50FT]]	50	4,839
A362150-7240	COLOR CLSR,PP,24-415,AMBER	1000	20,000
A2121-0010	BTL LRG W/M PP;1GAL,4L]]	6	9,570
A8755	PLATE, 384 SQ W, IMM 4,50/CS	50	29,462
A2002-0006	BTL N/M HDPE;6OZ,175ML	72	9,355
A362150-1240	COLOR CLSR,PP,24-415,WHITE	1000	20,000
A2105-0008	BTL W/M PP;8OZ,250ML]]	72	12,903
A362150-5240	COLOR CLSR,PP,24-415,RED	1000	20,430
A7134-0010	AUTOCLAV UTILITY CARRIER PP	6	12,366
ADS2185-0016	BOTTLE AMBER WM HDPE;500ML	48	11,935
A362150-4240	COLOR CLSR,PP,24-415,GREEN	1000	20,430
A322020-1000	BTL MEDIA BULK PETG;1000 ML	24	12,340
A3662-0100	GRADUATED CYLINDR PP;100ML	12	15,532
A8005-0360	TBG-980-PVC 1X1-5/16X5/32 50FT	50	29,247

Cat No.	Description	Packing	Price Rs.
A312003-0001	BTL BULK W/CL LDPE;1OZ N/M30ML	1000	72,043
A8005-0310	TBG-980-PVC 3/4X1X1/8 50FT	50	19,570
A5972-0516	HLF RACK TT UNWRE RED;16MM	8	10,645
A430805	8 WELL STRIP CAP, P.E. STERILE==	120	11,383
A2411-0250	DROP DISP BTL LDPE;250ML N/M	36	13,011
A5972-0020	HLF RACK TT UNWRE WHT ;20MM	8	11,075
A3122-1010	CENT BTL PC IEC; 1000ML	16	27,634
A8010-0250	TBG-489-PE 1/4X3/8X1/16 100FT==	100	5,376
A7120-0010	PAN HDPE;10 QT	6	11,613
A322020-0250	BTL MEDIA BULK PETG;250 ML	60	13,404
A8000-0080	TBG-180-PVC 1/4X1/2X1/8 50FT	50	9,140
A362150-6240	COLOR CLSR,PP,24-415,BLUE	1000	20,538
A6320-0010	FORCEPS PP	72	9,570
A3662-0500	GRADUATED CYLINDR PPCO; 500ML	8	17,660
ADS2085-0004	BOTTLE AMBER NM HDPE;125ML	72	7,527
A6283-1850	CLEAN SHEETS XLPE 18INX50 FT	2	24,086
A8051-0375	TBG 870 PFA 1/4X3/8 25FT	25	37,979
A8001-0204	TBG-180-MET 2.0X4.0X1.0 25M	25	3,333
A362150-0240	COLOR CLSR,PP,24-415,NAT]]	1000	20,538
A8000-4120	TBG-180-PVC 3/8X1/2X1/16 100FT	100	11,720
A8000-0260	TBG-180-PVC 5/8X7/8X1/8X50FT	50	16,129
A4110-1000	FLASK BAFFLED PC;1000ML	6	8,936
A8000-0200	TBG-180-PVC 1/2X3/4X1/8 50FT	50	14,194
A8010-0375	TBG-489-PE 3/8X1/2X1/16 100FT	100	7,312
A2003-9050	BTL N/M LDPE;1/2 OZ, 15 ML]]	72	3,763
A30 3000	3000ML 24 HR URINE CONTAINER	40	17,204
A5972-0416	HLF RACK TT UNWRE GRN;16MM	8	10,645
A8000-0210	TBG-180-VAC 1/2X1-1/8X5/16 50F	50	43,656
A1201-2000	BEAKER PP GRADUATED; 2000ML==	6	10,753
A5976-0513	RACK TT UNWIRE RED PP;13MM	8	10,215
A342821-1112	CLOS, MPV, LOW PRO, PINK, PPCO; 11MM	1	10,215
A250050	APPLICATOR SEALING 96 MICROWEL	2	4,086
A8000-1210	TBG-180-VAC 1/2X1-1/8X5/16 10F	10	9,892
A5972-0530	HLF RACK TT UNWRE RED;30MM	8	11,075
A8000-4080	TBG-180-PVC 1/4X1/2X1/8 100FT	100	16,989
A5976-0413	RACK TT UNWIRE GREEN PP;13MM	8	10,215
A3140-0500	CENT BTL W/SCA PC; 500 ML	24	38,817
A2003-0001	BTL N/M LDPE;1OZ,30ML]]	72	4,681
A378247	25 CELL REGULAR]]	24	13,978
A6432-0010	SPIGOT QUICK ACTION TEFZEL	2	7,742
A312199-0016	BTL IP2 W/M BULK HDPE; 16 OZ	125	35,699
A2120-0010	BTL LRG W/M HDPE;1GAL,4L]]	6	8,298
A5976-0313	RACK TT UNWIRE BLUE PP;13MM	8	10,215
A8000-9060	TBG-180-PVC 1/4X3/8X1/16 250FT	250	18,280
A362002-9125	BTL W/O CLSR,HDPE,4ML,NAT	2000	54,624
A8000-0140	TBG-180-PVC 3/8X5/8X1/8 50FT	50	11,505
A5972-0430	HLF RACK TT UNWRE GRN;30MM	8	11,075
ADS5116-0012	LABTOP COOLER,0 C, JR., PC; 12	Each	11,505
A312002-0006	BTL BULK W/CL HDPE;6OZ NM175ML	250	34,194
A4280-1500	FUNNEL BUCHNER PP;150MM	4	10,215
A312099-0001	BTL,IP2,BULK,HDPE;1 OZ	1000	72,366
A362002-0001	BTL W/O CLSR,HDPE,30ML,NAT	1000	60,753
A5972-0316	HLF RACK TT UNWRE BLU;16MM	8	10,860
A140085	EasyFill CF 1/4" Barbed Cap, Irrad.	1	6,774
A2105-0016	BTL W/M PP;16OZ,500ML]]	48	14,946
A2114-0008	BTL W/M SQR HDPE;8OZ. 250ML==	72	16,989
A8000-9180	TBG-180-PVC 1/2X5/8X1/16 250FT	250	30,108
A362004-9125	BTL W/O CLSR,AMBER HDPE,N/M4ML	2000	55,806

Cat No.	Description	Packing	Price Rs.
A5972-0520	HLF RACK TT UNWRE RED;20MM	8	11,075
A362008-9125	BTL W/O CLSR,HDPE,4ML, WHITE	2000	55,699
A2009-0008	BTL AMBR RCT HDPE;8OZ,250ML	72	16,989
A434797	F-8 OEM PACK MAXISORP==	120	59,362
A2220-0020	JUG LDPE;2GAL,8L	6	20,968
A362008-0004	BTL W/O CLSR,HDPE,125ML, WHITE	500	52,043
A8010-0625	TBG-489-PE 5/8X3/4X1/16 100FT	100	12,473
A362150-5280	COLOR CLSR,PP,28-415,RED	500	12,581
A5972-0013	HLF RACK TT UNWRE WHT;13MM	8	10,215
A5972-0330	HLF RACK TT UNWRE BLU; 30MM	8	11,075
A5972-0325	HLF RACK TT UNWRE BLU;25MM	8	11,075
ADS5300-0507	JAR MULTIPURPOSE PC;5X7	Each	5,054
A62070-00	VERSI-DRY; SA DISP, 20"X 100"]	400	16,915
A2317-0020	CRBY TRANS W/SPGT PC;10L	4	42,979
A382099-1000	BTL,LOW PARTIC. N/M, HDPE 32OZ	24	12,258
A2116-0015	JAR STRT SIDE W/M PC; 15 ML==	48	8,817
A5972-0420	HLF RACK TT UNWRE GRN;20MM	8	11,075
A2199-0016	BTL IP2 W/M HDPE;500ML,16 OZ]]	48	14,409
A362150-4280	COLOR CLSR,PP,28-415,GREEN	500	12,581
A8000-9120	TBG-180-PVC 3/8X1/2X1/16 250FT	250	24,624
A382099-0250	BTL,LOW PARTIC, N/M HDPE, 8 OZ	72	14,624
ADS3132-0058	CENT SEALING CAP PP;58MM	2	1,613
A5245-0040	PIPET WASHER-RINSER HDPE;D	6	109,247
A8000-9090	TBG-180-PVC 5/16X7/16X1/16 250	250	21,075
A8010-0500	TBG-489-PE 1/2X5/8X1/16 100FT	100	9,892
ADS2085-0008	AMBER N/M BTL HDPE;250ML	72	10,215
A4280-1100	FUNNEL BUCHNER PP;110MM	4	8,172
ADS6600-0010	STIRBAR STARHEAD TFE;10MM]]	Each	1,398
ADS2185-0004	BOTTLE AMBER WM HDPE;125ML==	72	9,462
A362150-0280	COLOR CLSR,PP,28-415,NAT==	500	12,796
A362150-7280	COLOR CLSR,PP,28-415,AMBER	500	12,581
A2105-0032	BTL W/M PP;32OZ,1000ML]]	24	8,617
A362150-1280	COLOR CLSR,PP,28-415,WHITE	500	12,581
A712411-1030	CLSR/SPOUT CAP DRP DISP BOT]]	25	6,237
A2099-0008	BTL IP2 N/M HDPE;250ML,8OZ	72	10,319
A5972-0320	HLF RACK TT UNWRE BLU;20MM	8	11,075
A5309-0250	DESICTR PP/PC;250MM	4	21,809
A448143	UNIVERSAL LIDS,WHITE NS	120	34,946
A362008-0008	BTL W/O CLSR,HDPE,250ML, WHITE	250	36,989
A8000-0070	TBG-180-PVC 1/4X7/16X3/32 50FT	50	7,634
A6900-0020	PAN STERILIZING PP; B.]]	6	20,215
A2004-0016	BTL AMBR N/M HDPE;16OZ,500ML==	48	13,763
A16-005	16x125 TT PS,NS (no cap)	1000	34,086
A362008-0032	BTL W/O CLSR,HDPE,1000ML,WHITE	50	19,892
A312009-0008	BTL RECT W/CL AMB HDPE;8 OZ	250	60,538
A2199-0004	BTL IP2 W/M HDPE;125ML,4 OZ==	72	10,323
A362150-6280	COLOR CLSR,PP,28-415,BLUE	500	12,796
A6316-1000	LABEL RTK CUSTOM POLYPAPER	150	47,634
A312006-0016	BTL BLK W/CLOS PP;16OZ NM]]	125	35,376
A5-002	0.5ML SAMPLE CUP, PS, NS	5000	44,839
A312110-0008	BTL WM SQR PP;8 OZ. 250ML	250	66,882
A8000-1145	TBG-180-VAC 3/8X7/8X1/4 10FT	10	7,097
A6910-0618	PAN INST/PIPET STERIL PP	6	18,298
A312114-0008	BTL BULK W/CLSR SQ HDPE;8OZ	250	62,688
A8000-4140	TBG-180-PVC 3/8X5/8X1/8 100FT	100	21,935
A8000-4200	TBG-180-PVC 1/2X3/4X1/8 100FT	100	27,742
A6900-0010	PAN STERILIZING PP;A==	6	12,473
A8010-0125	TBG-489-PE 1/8X1/4X1/16 100FT==	100	3,763

Cat No.	Description	Packing	Price Rs.
A2403-0125	WASH BTL FEP;125ML	4	17,097
ADS3132-0024	CENT SEALING CAP PP;24MM	2	1,398
A8051-0125	TBG 870 PFA 1/16X1/8 50FT	50	13,830
A8051-0187	TBG 870 PFA 1/8X3/1650FT	50	21,489
A8000-0065	TBG-180-VAC 1/4X5/8X3/16 50FT	50	16,989
A5970-0013	RACK TT UNWIRE WHITE; 13MM	8	14,409
A712154-0700	CLSR MASON JAR;70MM	12	2,366
A4252-0100	FUNNEL POWDER PPCO; 100MM	24	7,634
A712411-1125	CLSR/SPOUT CAP DROP DISP BOT	25	6,237
A8000-4090	TBG-180-PVC 5/16X7/16X1/16 100	100	10,000
A5972-0513	HLF RACK TT UNWRE RED;13MM	8	10,215
A362150-5200	COLOR CLSR,PP,20-415,RED	2000	31,935
A8000-0145	TBG-180-VAC 3/8X7/8X1/4 50FT	50	31,075
A5100-0036	CONTROL RATE FREEZER, 3.6ML	Each	5,213
A8000-0055	TBG-180-VAC 3/16X9/16X3/16 50F	50	14,516
A30 2500	2500ML 24 HR URINE CONTAINER	40	22,258
A362008-0001	BTL W/O CLSR,HDPE,30ML,WHITE	1000	69,140
A312004-0016	BTL BULK W/CL AMBER HDPE;16 OZ	125	38,172
ADS2185-0032	BOTTLE AMBER WM HDPE;1000ML	24	10,968
A5972-0413	HLF RACK TT UNWRE GRN;13MM	8	10,215
A2004-0032	BTL AMBR N/M HDPE32OZ,1000ML==	24	11,398
A312199-0008	BTL IP2 W/M BULK HDPE; 8 OZ	250	51,935
A4262-0110	FUNNEL LARGE HDPE;11 INCH	6	17,742
A714301-1025	SEP FUNNEL STOPCOCK ASSY TFE	1	5,161
A714301-1050	SEP FUNNEL STPCOCK ASSY TFE;2	Each	5,161
A6219-0068	DROPPER DISPOSABLE LDPE;68MM	1000	22,043
A8020-0625	TBG-689-PP 1/2X5/8X1/16 100FT	100	15,054
A8010-1000	TBG-489-PE 1X1-1/4X1/8 50FT	50	22,796
ADS5300-9609	JAR WITH COVER PC;4.7L	Each	6,452
A712172-0020	CLSR. PFA;20-415	2	2,043
A362150-4200	COLOR CLSR,PP,20-415,GREEN	2000	32,366
A5970-0113	RACK TT UNWIRE ORANGE; 13MM	8	14,301
A2004-0002	BTL AMBR N/M HDPE;2OZ,60ML	72	8,602
A362150-0200	COLOR CLSR PP 20-415 NAT==	2000	31,613
A2006-9050	BTL N/M PP;1/2 OZ, 15 ML]]	72	4,839
A2009-0032	BTL AMBR RCT HDPE;32OZ,1000ML	24	18,602
A5972-0313	HLF RACK TT UNWRE BLU;13MM	8	10,215
A2106-0032	BTL AMBR W/M HDPE;32OZ,1L==	24	15,319
A362150-6200	COLOR CLSR,PP,20-415,BLUE	2000	32,043
A362150-7200	COLOR CLSR,PP,20-415,AMBER	2000	32,366
ADS5241-0040	PIPET BASKET HDPE;D	Each	10,000
A312009-0032	BTL RECT W/CL AMB HDPE;32 OZ	50	39,570
A2004-0004	BTL AMBR N/M HDPE;4OZ,125ML	72	10,215
A5970-0513	RACK TT UNWIRE RED; 13MM	8	14,301
A362150-1200	COLOR CLSR,PP,20-415,WHITE	2000	32,366
ADS2185-0008	BOTTLE AMBER WM HDPE;250ML	72	14,194
A1201-4000	BEAKER PP GRADUATED; 4000ML==	4	12,366
A312016-1000	BOTTLE SQUARE PP;1000 ML	50	26,809
A3663-4000	GRADUATED CYLINDR PMP;4000ML	2	23,441
A2015-0125	BOTTLE SQUARE PC;125ML]]	48	15,957
A312004-0002	BTL BULK W/CL AMBER HDPE;2 OZ	1000	121,075
A2015-0500	BOTTLE SQUARE PC;500ML	24	16,064
A8051-0250	TBG 870 PFA 5/32X1/4 50FT	50	45,054
A5970-0413	RACK TT UNWIRE GREEN;13MM	8	14,301
A6378-0010	SAFETY WASTE FUNNEL, 83MM	2	13,011
A5245-0050	PIPET WASHER-RINSER HDPE;E	4	87,097
ADS2185-0002	BOTTLE AMBER WM HDPE;60ML ==	72	8,065
A5970-0313	RACK TT UNWIRE BLUE; 13MM	8	14,086

Cat No.	Description	Packing	Price Rs.
A2004-0008	BTL AMBR N/M HDPE;8OZ,250ML	72	13,978
A8001-0305	TBG-180-MET 3.0X5.0X1.0 25M	25	4,516
A2403-1000	WASH BTL FEP;1000ML	2	22,043
A2106-0016	BTL AMBR W/M HDPE;16OZ,500ML]]	48	17,419
A74018-00	VERSIDRY;SUPER MAT18"X 20"]]	350	18,723
A6132-2000	Repair Kit for New Style15cc PVC Pumps	4	16,774
A4110-0250	FLASK BAFFLED PC;250ML	12	9,032
A312106-0016	BTL BP WCL AMBR HDPE;16OZ W/M	125	45,914
A164709	1536 Well High Base CC White	25	169,677
A312199-0004	BTL IP2 W/M BULK HDPE; 4 OZ	500	81,935
A4106-0250	FLASK ERL SCRW CLS FEP;250ML	4	25,484
A1220-2500	BEAKER W/HANDLE HDPE;3000ML	6	18,172
A312004-0004	BTL BULK W/CL AMBER HDPE;4 OZ	500	74,839
A8001-1520	TBG 180 MET 15.0X20.0X2.5 10M	10	13,656
A2403-0500	WASH BTL FEP;500ML	4	35,484
A4108-0250	FLASK ERL SCRW CLS PC;250ML	12	10,108
ADS5116-0032	LABTOP COOLER,0 DEG C,PC;32	Each	21,828
A712150-1000	CLSR PP;100MM==	12	3,763
A4103-0250	FLASK ERLNMYR PC;250ML	12	9,462
A312004-0008	BTL BULK W/CL AMBER HDPE;8 OZ	250	50,753
A4150-1000	22ASK DEWAR HDPE;1L	4	83,511
A2004-0001	BTL AMBR N/M HDPE;1OZ,30ML==	72	7,957
A312199-0032	BTL IP2 W/M BULK HDPE; 32OZ	50	26,237
A712174-0530	CLSR ETFE;53MM==	2	3,226
ADS5300-9910	JAR WITH COVER PC;8.3L	Each	10,538
A2004-9025	BTL N/M AMB HDPE;1/4 OZ,8ML]]	72	5,806
A4475-11	Insert, color code, white	500	2,447
A3122-1000	CENT BTL PC;1000ML	16	26,989
A2403-0250	WASH BTL FEP;250ML	4	25,484
A1220-1250	BEAKER W/HANDLE HDPE;1000ML	6	15,699
A4260-0100	FUNNEL,HEAVY DUTY,LDPE;10 IN	2	9,247
A4106-0125	FLASK ERL SCRW CLS FEP;125ML	4	18,172
A8020-0500	TBG-689-PP 3/8X1/2X1/16 100FT	100	14,301
A2199-0032	BTL IP2 W/M HDPE;1000ML,32OZ==	24	13,118
A2414-0030	DROP DISP BTL FEP;30ML	4	11,613
A342825-0110	CLOS,MPV,W/O CODER,STER,AMBER PPCO;11 MM	1000	9,468
AAB-1443A	ALPS 50V Micoplate Heat Sealer w/carrier	Each	602,979
ADS2185-0001	BOTTLE AMBER WM HDPE;30ML	72	7,957
A2004-9050	BTL AMB N/M HDPE;1/2 OZ,15 ML==	72	6,022
A312106-0004	BTL BP WCL AMBR HDPE;4OZ WM12	500	93,011
A2106-0008	BTL AMBR W/M HDPE;8OZ,250ML	72	19,892
A140086	EasyFill CF 3/8" Barbed Cap, Irrad.	1	6,774
A8020-0370	TBG-689-PP 1/4X3/8X1/16 100FT	100	10,968
A4280-0900	FUNNEL BUCHNER PP;90MM	4	5,699
A712150-0430	CLSR PP;43MM==	12	1,075
A715920-0650	POST PETRI DSH RCK PC;6.5 IN	4	1,828
A2407-0500	WASH BTL W/M LDPE;500 ML	24	7,234
A5500	LID, STERILE, 100/CS	100	13,936
A342089-0004	BOTTLE, N/M,HDPE,125ML,STR==	240	17,979
ADS2420-0125	DISP BTL AUTOCL PPCO; 125 ML	6	3,333
ADS5241-0050	PIPET BASKET HDPE;E	Each	13,226
A30 0013	PATIENT & TEST INFO LABEL	250	20,753
A4416	Cap Strips, S Non Sep	240	13,723
A3664-0100	GRAD CYLINDR ECON PP;100 ML]]	12	4,255
ADS2420-0250	DISP BTL AUTOCL PPCO; 250 ML	6	3,763
A1350-0001	Labware Value Pack	Each	22,151
A713132-0063	ORING SLNGCP SILICONE;63 MM	10	2,366
A6255-0508	SAMPLE BAG LDPE;5X8IN	500	17,204

Cat No.	Description	Packing	Price Rs.
A5970-0225	RACK TT UNWIRE YELLOW; 25MM	8	15,914
A710315-0003	COVER W/3 TPE CAPS	Each	1,183
A712151-0380	HDPE CLOSURE 38MM;WHITE	12	1,075
A2106-0002	BTL AMBR W/M HDPE;2OZ,60ML	72	11,183
A8001-0407	TBG-180-MET 4.0X7.0X1.5 25M	25	9,462
A712150-0280	CLSR PP;28MM	12	860
A2106-0001	BTL AMBR W/M HDPE;1OZ,30ML	72	10,860
ADS5241-0020	PIPET BASKET HDPE;B	Each	10,323
A3662-4000	GRADUATED CYL PP;4000ML==	2	22,258
A312106-0002	BTL BP WCL AMBR HDPE;2OZ WM60	1000	163,118
A712150-0530	CLSR PP;53MM	12	1,613
A712150-0240	CLSR PP;24MM==	12	860
A8001-0406	TBG-180-MET 4.0X6.0X1.0 25M	25	7,527
A30 0012	PATIENT INSTRUCTION LABEL	1500	20,860
A8001-0913	TBG-180-MET 9.0X13.0X2.0 25M	25	24,194
A713650-1025	STOPCOCK ASSEMBLY ACRL BURET	2	12,688
A717135-0001	LATCH ASSY, BIO-TC,NATURAL PC	4	2,796
A342035-0010	PETG BTL W/LINED CLSR,10ML,STR	500	48,936
A2423-0500	UNITARY WASH BTL ASSORT, LDPE	16	7,872
A8001-0812	TBG-180-MET 8.0X12.0X2.0 25M	25	22,903
A711010-9507	SETTLOMETER JAR W/COVER PC	Each	10,323
A312106-0001	BTL BP WCL AMBR HDPE;1OZ WM30	1000	158,495
A2401-0500	WASH BTL ECON LDPE;500ML;NMJ]	24	6,489
A3121-0250	CENT BTL HDPE;250ML	36	15,699
A8001-0811	TBG-180-MET 8.0X11.0X1.5 25M	25	21,935
A8001-0508	TBG-180-MET 5.0X8.0X1.5 25M	25	13,011
A8001-1014	TBG-180-MET 10.0X14.0X2.0 25M	25	27,634
ADS3125-0250	CENTRFGE BTL ADPTR LDPE;250ML	6	5,376
A712171-0530	CLSR AMBR PP;53MM==	12	1,935
A8001-1216	TBG-180-MET 12.0X16.0X2.0 25M	25	30,860
ADS2153-0700	CLSR FLUIDTRNSFR PP;70MM	6	3,226
A712160-0384	CLSR CRBY/LRG BTL PP;38-430	12	1,828
A8001-0610	TBG-180-MET 6.0X10.0X2.0 25M	25	19,355
A712150-0630	CLSR PP;63MM	12	2,366
A713132-0058	ORING SLNGCP SILICONE;58 MM	10	2,366
A713141-PPCO	RED O-rings f/3141-1006;-1002	6	11,613
A8001-0710	TBG-180-MET 7.0X10.0X1.5 25M	25	21,075
A8001-0609	TBG-180-MET 6.0X9.0X1.5 25M	25	17,742
A4221-025	Foil, SampleSeal 25um	Each	127,419
AAB0972	Abgene Mltspl Splt Septm Plgs, 7 mm, Bulk	1000	33,333
A5306-0070	VACUUM PLATE PP;7IN	1	21,290
A342060-0125	Bottle, Square, PET, 125mL w/TE Clos.,ST	24	12,366
A342060-0250	Bottle, Square, PET, 250mL w/TE Clos.,ST	30	12,366
A342060-0650	Bottle, Square, PET, 650mL w/TE Clos.,ST	24	11,613
A342060-1000	Bottle, Square, PET,1000mL w/TE Clos.,ST	12	10,215
A4220-096	SampleSeal 96- Seal/ Cutter	Each	5,935,699
A5221-WM384	SampleArray Weigh Module Acc 384-	Each	679,355
A5221-WM4896	SampleArray Weigh Module Acc 48- 96-	Each	679,355
A5A 0030	35mm SPC Cap only, NAT, NS	4000	24,194
A5A 0037	35mm SPC Cap, Orange, NS	4000	24,194
A15-003	15ml CENTRIFUG TB PP,NS no cap	500	16,667
A331840	LP 5mL Empty Rack with Lid, 10/cs	10	11,935
A4903	0.75ml Empty Latch Rack Lids, NS, 10/cs	1	4,731
A7A 0250	FUNNELS, PE WHITE NS	1	12,473
A4150-4000	FLASK DEWAR HDPE;4L	2	46,383
A3120-9500	CENT BTL PPCO;500MLJ]	24	14,086
A5312-0230	DESICTR PLT CRMC/MTL;230MM	6	27,021
A4102-2000	FLASK ERLNMYR PP;2000ML	6	9,362

Cat No.	Description	Packing	Price Rs.
A342089-0008	BOTTLE, N/M,HDPE,250ML,STERILE	180	18,298
A342089-0002	BOTTLE, N/M, HDPE,60ML,STERILE	540	37,766
A4000-1000	FLASK VOLUMETRIC PP;1000ML	6	25,638
A74050-00	VERSI-DRY:SUPER ROLL,20"X 100"]	400	20,851
A236370	SEALING TAPE, POLYESTER NS	100	11,277
A6745-9024	LARGE BETA WASTE SHIELD ACRY	Each	52,660
A2421-0500	SOLVENT WASH BTL FLPE;500ML	24	13,723
A267461	384 PP SW STD HT BLACK 25/100	100	72,660
A342020-0060	STER. PETG MEDIA BTL., 60ML]]	200	28,511
A3664-0010	GRAD CYLINDR ECONOMY PP; 10 ML	24	7,340
A1203-0250	BEAKER PMP GRADUATED; 250ML	24	11,383
A2402-0500	WASH BTL UNITARY LDPE;500ML]]	24	8,936
A3664-0050	GRAD CYLINDR ECONOMY PP; 50 ML	18	5,106
A8050-0187	TBG 890 FEP; 1/8 X 3/16 50FT	50	8,298
A312189-0016	BTL PKG W/M HDPE; L/W500ML]]	125	15,000
A5317-0070	DESCTR CAB ACRY;12X12X7 IN.	Each	28,936
A3664-0500	GRAD CYLINDR ECONOMY PP;500 ML	8	5,319
A2402-0250	WASH BTL UNITARY LDPE; 250ML==	36	11,170
A2320-0050	CRBY REC W/SPG HDPE;5GAL,20L==	4	35,106
A241205	Sealing Tape Rayon White Ster	50	10,319
A7002-0025	BUCKET W/GRAD HDPE;2 1/2GAL	6	21,809
A7571	PLATE, 96W, ML 1+, FB, 50/CS]]	50	17,128
A2204-0010	BTL AMBR LARGE PP;1 GAL, 4L	6	10,638
A8050-0310	TBG 890 FEP; 1/4 X 5/16 50FT	50	15,745
A269390	0384 Deepwell Plate PP Nat NS	60	25,197
A2320-0020	CRBY RCT W/SPGT HDPE;2GAL,9L	6	41,702
A4252-0150	FUNNEL POWDER PP;150MM	24	9,149
A253623	LOW BOT LID UNIVERSAL N/S	100	30,532
A5833-0001	DISPNSR; PARAFILM, 6X4X6, ACR	Each	5,213
A264611	LID,NUNC,384WELL PLATE STERILE	60	20,851
A5317-0120	DESCTR CAB ACRY;12X12X12 IN.	Each	37,340
A2116-0030	JAR STRT SIDE W/M PC; 30 ML	48	9,681
A3501	Microliter plate sealer	100	5,000
A6423-0010	SPIGOT CLOSURE;PP	24	8,298
ADS5114-0012	QUICK CHILL, PC; 12 PLACE	Each	10,532
A378220	81 CELL REGULAR]]	6	3,298
A312185-0001	BTL PACKAGING WM AMBER 1 OZ	1000	54,574
A5116-1600	LABTOP COOLR,TT,0 DEG,16MM,PC	Each	9,787
A5970-0025	RACK TT UNWIRE WHITE; 25MM	8	15,426
A2317-0050	CRBY TRANS W/SPGT PC;20L	4	58,404
A2116-0250	JAR STRT SIDE W/M PC; 250 ML	24	11,277
A4250-0160	FUNNEL ANALYTICAL PP;160MM	12	12,447
A6132-0020	REPR HANDPUMP W/GAGE PVC; 36CC	4	49,149
A4301-2000	FUNNEL SEPARATRY FEP;2000 ML	2	35,745
A2116-1000	JAR STRT SIDE W/M PC;1000 ML==	16	14,681
A312002-9125	BTL BULK W/CLOS HDPE;1/8 OZ]]	2000	73,936
A2006-0032	BTL N/M PP;32OZ,1000ML]]	24	7,660
A2321-0050	CRBY RECT W/SPG PP 5 GAL/20L	4	41,596
A2116-0060	JAR STRT SIDE W/M PC; 60 ML	48	11,489
A438733	MICROWELL TRAY,72 WELL,W/LID]]+	100	23,511
A6250-0018	SAMPLE VIAL W/CLSR LDPE;18ML	144	9,468
A4250-0100	FUNNEL ANALYTICAL PP;100MM	24	10,213
A3855	PLATE, 96W, IMM 4, 50/CS]]	50	18,085
A2006-0016	BTL N/M PP;16OZ,500ML==	48	11,702
A2301-0050	CRBY W/TUB PP; 20L	4	30,957
A2205-0032	LARGE N/M BOTTLE, PC; 1000ML	24	15,957
A6422-0010	SPIGOT QUICK ACTION PP==	12	20,957
A2104-0002	BTL W/M HDPE;2OZ,60ML]]	72	6,064

Cat No.	Description	Packing	Price Rs.
A4252-0065	FUNNEL POWDER PP;65MM==	36	7,447
A8051-0500	TBG 870 PFA 3/8X1/2 25FT	25	52,021
A5701	SEALER, MYLAR, 100/CS	100	5,319
A5922-0024	RACK PETRIDISH ACRYLIC;100MM	4	17,766
A1223-1000	BEAKER W/HANDLE PMP; 1L	6	17,766
A2105-0004	BTL W/M PP;4OZ,125ML]]	72	9,787
A3140-0250	CENT BTL W/SC PC;250 ML	36	47,340
A2199-0008	BTL IP2 W/M HDPE;250ML,8 OZ	72	15,532
A4463BLU	SepraSeal CapMat, Blue, NS, 10 mats/ cs	10	6,667
A2125-1000	BTL HEAVY DUTY HDPE;1000ML	24	18,710
A2106-0004	BTL AMBR W/M HDPE;4OZ,125ML	72	13,298
A3666-0100	GRADUATED CYLINDER, PFA; 100ML	Each	19,149
A8075	Reservoir, Auto. Reagent 75ML	1	6,064
A4415MX	Cap Strips, Non-Sterile, Non Separable, Round Pierceable	240	9,894
A3455MBP	PLATE, 96W, IMM 2, FB, 50/CS]]	50	15,426
A142744	R Btl,1450CM², PS, Easy On/Off DB, Ster	20	14,574
A383423-42	Nalgene Certified Clean 20L PC Biotainer with Handle, Sterile and USP<788> Compliant	3	34,149
A225-20S	Samco 7.5mL Graduated Transfer Pipets, L	4000	14,516

Pristine Biomedical employs under privileged or not-so-privileged individuals from very remote & unreachable parts of India, trains them, hires them & tries to make them efficient.



Shobhit K Saxena



Arvind Sahu



Piyali Das



Rubal Rana



Dr. John M Lima



Dr. Rashmi Jain



Swati Das



Babita Suman



Dolly Chakraborty



Sanjay K Swain



Indu Sharma



Anwesh Das



Biswabandhu Das



Prakash Shah

Pristine Biomedical

Guru Harkishan Plaza,(Suite #6),CB 201,Naraina, New Delhi 110028

Ph: +91 96 542 73263, +91 98 713 98048 Email:pristbio@gmail.com , <https://www.pristinebiomedical.com>

Email: info@pristinebiomedical.com

<http://www.pristinebiomedical.com>



INDEX

alphabetical arrangement of titles as
per their page numbers

2022

PRISTINE BIOMEDICAL

CB 201, Suite #6, Guru Harkishan Plaza
Industrial Area, Naraina Ring Road
New Delhi 110028

Ph: +91 965 427 3263, +91 888 278 0325
info@pristinebiomedical.com, pristbio@gmail.com
<https://www.pristinebiomedical.com>

INDEX

(ALPHABETICAL ARRANGEMENT OF TITLES AS PER THEIR PAGE NUMBER)

PRISTINE BIOMEDICAL THE BRAND APART, THE STRAND APART			PRISTINE BIOMEDICAL THE BRAND APART, THE STRAND APART		
SL. NO	DESCRIPTION	PAGE NO	SL. NO	DESCRIPTION	PAGE NO
1	A.P. BOTTLE (PNEUMOTHORAX BOTTLE)	108		TRIMBLE, NIKON, SOKKIA, LABLINE & SCIBIO ETC.	
2	ACRYLIC LABELS (FIELD)	31	33	BATTERY JARS (DIA.XHT. CM)	109
3	ACRYLIC LABELS T SHAPE	31	34	BEAKER	25
4	ACTIVITY GAUGE	113	35	BEAKER GRADUATED, LOW FORM	105
5	AGAROSE FOR ELECTROPHORESIS	74	36	BEAKER GRADUATED, TALL FORM	105
6	AGGREGATE IMPACT TEST APPARATUS	103	37	BEAKER GRIFFIN LOW FROM	108
7	AIR ENTERTAINMENT METER	104	38	BEAKER LOW FORM GRADUATED (SCREEN PRINTED)	109
8	ALCOHOL TESTER	97	39	BED PAN	113
9	ALICE TISSUE FORCEP	113	40	BED SIDE SCREEN	113
10	ALUMINIUM LABLE-SCINATION	126	41	BELL JAR KNOBBED (DIA.XHT. CM)	109
11	AMBU BAG +ROLLER	113	42	BELL JARS WITH KNOB & GROUND RIM (CLOSED AT TOP) (DIA.XHT. CM)	109
12	AMPOULE FILLING & SEALING MACHINE	113	43	BELL JARS WITH STOPPER ON TOP AND GROUND RIM (OPEN AT TOP)(DIA.XHT. CM)	109
13	AMPOULE WASHING	113	44	BENCHTOP MINI COOLERS	32
14	ANATOMY STUDY MODELS	149	45	BETA RADIATION WIZARD	19
15	ANEMIA CAN	113	46	BIOHAZARD BAGS	8
16	ANTIBIOTIC ZONE READER	113	47	BIOHAZARD WASTE CONTAINER	19
17	ARA HARVEST BASE WELLS	22	48	BIOLOGICAL INDICATORS	87
18	ARTERY FORCEP	113	49	BIOLOGICAL STABILIZATION PRODUCTS	119
19	ARTERY FORCEP S.S. ISI MARK	113	50	BIO-SOIL / SOIL CONDITIONER	61
20	ASEPTIC CABINET	113	51	BIRD SCARING RIBBON-SCINATION	126
21	AUTO KARL FISHER TITRIMETER	100	52	BITUMEN EXTRACTOR	103
22	AUTOCLAVABLE BAG FOR MUSHROOM-SCINATION	124	53	BLAIN AIR PERMEABILITY APPARATUS	103
23	AUTOCLAVABLE BAGS	8	54	BLOTTING PAPER	78
24	AUTOMATIC CUT OFF DEVICE FOR ABOVE	105	55	BLOTTING SYSTEMS (SEMI DRY ELECTROBLOTTERS)	72
25	AUTOMATIC LEVEL EXPLORER (AUTO LEVEL)	94	56	BOTTLE FILLING MACHINE	113
26	B.O.D. BOTTLE	105	57	BOTTLE GAS WASHING DRESCHEL (PLAIN)	109
27	B.P INSTRUMENTS	113	58	BOTTLE SEALING MACHINE	113
28	B.P. BLADE	113	59	BOTTLE TOP DISPENSERS	27
29	B.P. INSTRUMENTS STAND	113			
30	BALL MILL	113			
31	BANDAGE CUTTING SCISSOR	113			
32	BATTERY FOR ALL TOTAL STATION LIECA, TOPCON,	101			

PRISTINE BIOMEDICAL THE BRAND APART, THE STRAND APART		
SL. NO	DESCRIPTION	PAGE NO
60	BOTTLE WASHING MACHINE	113
61	BOTTLE WITH RUBBER TEAT AND GLASS DROPPER(ML)	109
62	BOWL / BOUL	113
63	BOX FOR MICRO CENTRIFUGE TUBES	33
64	BREAST PUMP	109
65	BREEDING JAR MOSQUITO	31
66	BRUNTON COMPASS	95
67	BULK AND DENSITY SET	103
68	BULK DENSITY APPARATUS	113
69	BURETTE SCREW ROTA FLOW STOPCOCK	105
70	BURETTE WITH PINCH CLIP COMPLETE WITH RUBBER TUBE AND JETS	109
71	BURETTE WITH PINCH CORK	105
72	BURETTE WITH STOPCOCK	109
73	BURETTE WITH STRAIGHT GLASS STOPCOCK	105
74	BUTTER PAPER BAG-SCINATION	125
75	CALCIUM CHLORIDE TOWER	109
76	CAMMO/ GT PATTERN	99
77	CANADA BALSAM BOTTLE WITH GLASS ROD	109
78	CAP FOR FIELD/BALCALAVA / BARRAY	99
79	CAP FOR JAM BOTTLE	43
80	CAPSULE COUNTER	113
81	CAPSULE FILLING	113
82	CARDBOARD CRYO BOX	33
83	CAVITY BLOCK SIZE MM	109
84	CBR MACHINE SINGLE SPEED COMPLETE WITH ALL STANDARD ACCESSORIES	104
85	CBR MOTORIZED CUM HAND OPERATED	98
86	CELL CULTURE DISH	42
87	CELL CULTURE DISH GLASS	47
88	CELL CULTURE DISH, GLASS BOTTOM	48
89	CELL CULTURE FLASKS	39
90	CELL CULTURE PLATE	41

PRISTINE BIOMEDICAL THE BRAND APART, THE STRAND APART		
SL. NO	DESCRIPTION	PAGE NO
91	CENTRIFUGAL TUBE GRADUATED	105
92	CENTRIFUGAL TUBE PLAIN,	105
93	CENTRIFUGAL TUBE WITH SCREW CAP	105
94	CENTRIFUGE MACHINE	113
95	CENTRIFUGE TUBE 25 ML	113
96	CENTRIFUGE TUBE RACK 50ML	37
97	CENTRIFUGE TUBES	56
98	CHARGER FOR ALL TOTAL STATION LIECA, TOPCON, TRIMBLE, NIKON, SOKKIA, LABLINE & SCIBIO ETC.	102
99	CHEATLE FORCEPS	113
100	CHEMICAL INDICATORS	88
101	CLINICAL CHEMISTRY: BIOCHEMISTRY / DIAGNOSTICS REAGENTS / KITS	143
102	CLINICAL THERMOMETER	113
103	COATING PAN	113
104	COLONY COUNTER	100
105	COMPACTION FACTOR APPARATUS COMPLETE SET	104
106	COMPRESSION TESTING MACHINE COMPLETE WITH CALIBRATION REPORT	102
107	COMPRESSOMETER	104
108	CONCRETE TEST HAMMER	95
109	CONCRETE TEST HAMMER	103
110	COND., TDS&TEMP.METER	100
111	CONDENSER ALLIHN WITH I/C JOINT	105
112	CONDENSER DOUBLE SURFACE	106
113	CONDENSER LIE BIG PLAIN	105
114	CONDENSER LIE BIG WITH I/C JOINT	105
115	CONDENSOR GRAHAM COIL TYPE I/C JOINT	106
116	CONICAL FLASK	107
117	CONSOLIDATION TEST APPARATUS COMPLETE SET	104
118	CONTACTLESS HAND SANITIZER	86
119	CONTAINER SEAL	3
120	CONVULSO METER	113

PRISTINE BIOMEDICAL THE BRAND APART, THE STRAND APART		
SL. NO	DESCRIPTION	PAGE NO
121	CORE CUTTER WITH RAMMER & DOLLY	98
122	CORE DRILLING MACHINE	104
123	COTTON ROLLS	85
124	COUNTING BOARD 50/100 HOLES-SCINATION	126
125	COUPLING JAR	109
126	CROSS LINE LASER ACL SERIES	95
127	CRUSHING VALUE APPARATUS	103
128	CRYO BOX (PC)	34
129	CRYO BOX (PP)	34
130	CRYO GLOVES	11
131	CRYO VIALS	34
132	CRYO WORKSTATION	35
133	CRYO-BABIES AND CRYO-TAGS	4
134	CRYSTALLIZING DISHES FLAT BOTTOM (SIZE IN CM)	109
135	CUBE MOULD	104
136	CUBE MOULD	98
137	CULTURE TUBE	46
138	CULTURE TUBE MEDIA WITH SCREW CAP & RUBBER LINER ROUND / FLAT BOTTOM	107
139	D&C SET	113
140	D.T. MACHINE	113
141	DEEPWELL PLATE	39
142	DENSITY BASKET	103
143	DESICATORS WITH COVER	109
144	DESICCATORS PLAIN	107
145	DESICCATORS PYREX TYPE VACUUM	109
146	DESICCATORS VACUUM	26
147	DESICCATORS VACUUM	107
148	DIAL THERMOMETER FOR BITUMEN	99
149	DIAMOND CORE CUTTER WITH DIESEL ENGINE	98
150	DIGITAL ALTIMETER	97
151	DIGITAL ANEMOMETER	97
152	DIGITAL CONDUCTIVITY METER	100
153	DIGITAL DEPTH GAUGE	97
154	DIGITAL DISSOLVED OXYGEN	100

PRISTINE BIOMEDICAL THE BRAND APART, THE STRAND APART		
SL. NO	DESCRIPTION	PAGE NO
155	DIGITAL FRIABILITY TEST APPARTUS (SINGLE DRUM)	101
156	DIGITAL INCLINOMETER	97
157	DIGITAL INSULATION TESTER	97
158	DIGITAL MELTING POINT APPARATUS	114
159	DIGITAL MULTIMETER	97
160	DIGITAL MULTIMETER POCKET SIZE, MULTIFUNCTION, DATA HOLD	97
161	DIGITAL PLANIMETER	95
162	DIGITAL SOIL MOISTURE METER	97
163	DIGITAL THERMOMETER	93
164	DIGITAL THERMOMETER	114
165	DIGITAL TONG TESTER	97
166	DIGITAL WIRELESS WEATHER STATION	97
167	DIRECT SHEAR TEST APPARATUS COMPLETE SET WITH PROVING RING AND DIAL GAUGE	104
168	DISINFECTANT SPRAY	84
169	DISINTEGRATOR APPARATUS	114
170	DISPOSABLE COVERALLS	14
171	DISSECTING FORCEPS	113
172	DISSOLUTION RPM	114
173	DISSOLUTION TEST APPARATUS	114
174	DISTANCE METER PD SERIES	94
175	DISTILLATION APPARATUS AUTOMATIC	105
176	DISTILLATION FLASK R.B. SIDE TUBE	105
177	DISTILLATION SET	105
178	DLC HAMMER MACHINE	104
179	DNA DEGRADATION SOLUTION	85
180	DNA STABLE	120
181	DOLLY CUTTER	104
182	DOMESTIC ADVANCED DIGITAL CIRCUIT	101
183	DOT LABELS & STRIPS	3
184	DOUBLE CONE BLENDER WITH MOTOR	114
185	DOUBLE UNIT ORANGE BATH	114
186	DRESSING DRUM	114

PRISTINE BIOMEDICAL THE BRAND APART, THE STRAND APART		
SL. NO	DESCRIPTION	PAGE NO
187	DRESSING SCISSOR	114
188	DROPPING BOTTLE WITH GALSS STOPPER (TKPATTERN)	109
189	DROPPING BOTTLE WITH GLASS STOPPER (T. KPATTERN,) AMBER COLOUR	109
190	DROPPING BOTTLE WITH PIPETTE STOPPER	105
191	DRY BATH MINI	67
192	DUCTILITY TEST APPARATUS COMPLETE SET	103
193	DURA SEAL	5
194	DYNAMIC CONE PENETROMETER COMPLETE SET	104
195	EDDY HOT PLATE	114
196	ELECTRIC BAG SEALER	31
197	ELECTRONIC BALANCE 1 GM TO 10 KG	99
198	ELECTRONIC THEODOLITE	94
199	ELECTROPHORESIS SYSTEM HORIZONTAL	69
200	ELECTROPHORESIS SYSTEMS- VERTICAL	71
201	ELISA KITS / RIA KITS	143
202	ELISA PLATE	38
203	EMERGENCY FLUORESCENT LIGHTING DOUBLE TUBE, 230 V	114
204	ENGINEER PLANE TABLE COMPLETE EXPORT	97
205	ENGINEER PLANE TABLE COMPLETE STANDARD	97
206	ENORSAND BAG	103
207	ERLENMEYER FLASK NARROW MOUTH CONICAL (SERREEN PRINTED)	110
208	ERLENMEYER FLASKS NARROW MOUTH CONICAL)	109
209	EXTENSOMETER	104
210	FACE MASK	12
211	FEMALE CONNECTOR	117
212	FETAL MONITOR PULSE METER	114
213	FIBRE GLASS TELESCOPIC STAFF	96

PRISTINE BIOMEDICAL THE BRAND APART, THE STRAND APART		
SL. NO	DESCRIPTION	PAGE NO
214	FILTER FLASK PLAIN 'HEAVY FILTRATION	105
215	FILTER PAPERS	52
216	FLAME PHOTOMETER	100
217	FLASH AND FIRE TEST APPARATUS	103
218	FLASK CONICAL	110
219	FLASK FILTERING WITH TABULATURE AT SIDE HEAVY WALL	110
220	FLASK FLAT BOTTOM	110
221	FLASK IODINE	110
222	FLASK R.B. LONG NECK (RETORTED)	110
223	FLASK ROUND BOTTOM	110
224	FLASK VOLUMETRIC STOPPER (MEASURING/STANDARD FLASK)	110
225	FLAT BOTTOM FLASK	105
226	FLAT BOTTOM FLASK JOINT B 24/29	106
227	FOLIN TUBE BLOOD SUGAR TUBE	106
228	FOOT PROTECTION	11
229	FOOTSTEP SS	114
230	FREEMAN MEASURING WHEEL	98
231	FREEMAN MEASURING WHEEL DIGITAL	98
232	FREEMAN TAPE 15 METER	98
233	FREEZER RACKS & INVENTORY SYSTEMS	1
234	FREEZER THERMOMETER	18
235	FRIABILITY DIGITAL RPM	114
236	FROG BOARD	114
237	FUNNEL	20
238	FUNNEL	106
239	FUNNEL 60 ANGLE PLAIN DIA CM	110
240	FUNNEL BUCKNER WITH SINTERED DISC	106
241	G.P.S. GARMIN	95
242	GAS GENERATING APPARATUS KIPPS	110
243	GAS GENERATING KIPS APPARATUS COMPLETE WITH	110

PRISTINE BIOMEDICAL THE BRAND APART, THE STRAND APART		
SL. NO	DESCRIPTION	PAGE NO
	DELIVERY TUBE AND THISTLE FUNNEL	
244	GAS JARS WITH GROUND FLANG AND FOOT WITHOUT LID DIA.XHT.CM	110
245	GAS WASHING BOTTLE WITHOUT FITTING	110
246	GAUGING TROWEL	103
247	GEOLOGICAL HAMMER	95
248	GERMINATION PAPER	78
249	GLOBAL POSITIONING SYSTEM	94
250	GLOVE BOX HOLDER	16
251	GLOVES: IMPORTED	100
252	GLUCOMETER	114
253	GOLD LEAF JAR	110
254	GOLDEN YELLOW SEED PACKET-SCINATION	125
255	GOOCH CRUCIBLE G-1/G-2/G-3/G-4/G-5	106
256	GREEN NETS FOR SUNROOF (PRICE/2 FEETS)	31
257	HAEMOCYTOMETER	31
258	HAND GRINDING MILL	114
259	HAND OPERATED VACUUM PUMP	28
260	HAND SANITIZER	16
261	HAND TORCH 3 CELL	114
262	HEAD COVER	12
263	HEART LEVER	114
264	HEAVY DUTY ASPIRATORS	21
265	HEMOGLOBIN METER	100
266	HIGH TEMPRATURE INDICATOR TAPE	5
267	HIGH-LOW TEMPRATURE INDICATOR TAPE	7
268	HISTAMINE CHAMBER	114
269	HOSPITAL WHEELCHAIR FOLDING	114
270	HOT WATER BAG	114
271	HYDROMETER JARS	111
272	IMPACT TESTING MACHINE WITH COUNTER	98
273	IMPORTED PARCHMENT PAPER BAG-SCINATION	125

PRISTINE BIOMEDICAL THE BRAND APART, THE STRAND APART		
SL. NO	DESCRIPTION	PAGE NO
274	INDICATOR TAPE FOR STEM AUTOCLAVE	5
275	INFRARED MOISTURE METER	97
276	INFRARED THERMOMETER	92
277	INFUSION PUMP	114
278	INOCULATION LOOPS & SPREADERS	48
279	INSECT COLLECTION NET	123
280	INSECT PROOF NYLON NETTING. UV STABILIZED	122
281	INSECT TRAP POLYTHENE BAG YELLOW COLOUR	122
282	INSERTION TOOL	117
283	INSTRUMENT BOX OF 13 PARTS	97
284	INSTRUMENT BOX OF 5 PARTS	97
285	INSTRUMENT STERILIZER	114
286	IODINE FLASK	107
287	IODINE FLASK STOPPERED	111
288	IUCD SET STAINLESS STEEL	114
289	IV STANDS FOR HOSPITAL, HEAVY DUTY	114
290	JACKET REVERSIBLE	99
291	JACKET WIND PROOF	99
292	JARS COPLIN WITH COVER	111
293	JARS STAINING RECTANGULAR WITH COVER	111
294	JUMPING BOX	114
295	KIDNEY TRAY	114
296	KIMTECH WIPERS	14
297	KINEMATIC VISCOSITY BATH DIGITAL	31
298	KIPPS APPARATUS	107
299	KOCHER FORCEPS	114
300	KRAFT PAPER BAG-SCINATION	124
301	KRAFT SEED CONTAINER STAR PAPER-SCINATION	125
302	L.P. NEEDLE	114
303	LAB COAT COTTON WASHABLE	31
304	LAB CONCRETE MIXER	104
305	LAB UTILITY TRAY	86
306	LABCOAT DISPOSABLES	13
307	LABORATORY	114
308	LABORATORY APRON	122

PRISTINE BIOMEDICAL THE BRAND APART, THE STRAND APART		
SL. NO	DESCRIPTION	PAGE NO
309	LABORATORY BURNER	18
310	LABORATORY IDENTIFICATION	62
311	LABORATORY LABEL PRINTER	62
312	LABORATORY LABELLING TAPE	8
313	LABORATORY MARKERS	7
314	LABORATORY SPATULA	79
315	LABORATORY SPATULA	79
316	LABORATORY TUBES & RODS	112
317	LACHLANCHE CELL POST	111
318	LASER PLUMMET RC-10SERIES	95
319	LENGTH GAUGE AND THICKNESS GAUGE SET	104
320	LEVELING STAVES	96
321	LIFE JACKET	99
322	LINT FREE WIPES	121
323	LIQUID LIMIT DEVICE	103
324	LOS ANGELES TEST APPARATUS COMPLETE SET (FULL BODY)	103
325	LUGGAGE LABEL-SCINATION	126
326	MAGENT BOX TRANSPARENT	43
327	MAGNETIC STIRRER	68
328	MAGNETIC STORM	114
329	MANNUAR	78
330	MANOMETER	97
331	MANUAL SPRAYER HEAVY DUTY	91
332	MARKIN CLOTH BAG-SCINATION	125
333	MARSHAL STABILITY MACHINE	104
334	MARSHALL STABILITY MOTORIZED CUM HAND OPERATED (COMPLETE WITH ALL ACCESSORIES)	98
335	MATHEMATICAL MODEL & KITS	154
336	MAYO SCISSORS	114
337	MEASURING CYLINDER	21
338	MEASURING CYLINDERS	111
339	MEASURING CYLINDERS HEXAG BASE	107
340	MEASURING CYLINDERS ROUND BASE	107
341	MEASURING CYLINDERS, I/C STOPPERD	107
342	MEASURING WHEEL	95

PRISTINE BIOMEDICAL THE BRAND APART, THE STRAND APART		
SL. NO	DESCRIPTION	PAGE NO
343	MEDIA BOTTLE COMPLETE WITH ALUMINUM CAP AND RUBBER WASHER	111
344	MEDICINE GLASS	111
345	MEDICINE TROLLY	114
346	MELTING POINT APPARATUS	100
347	MEMBRANE FILTERS	51
348	MICRO OPTIC THEODOLITE	94
349	MICROCENTRIFUGE	68
350	MICROCENTRIFUGE TUBE RACKS	36
351	MICROCENTRIFUGE TUBES	57
352	MICROCOVER GLASSES	80
353	MICROFLEX GLOVES	55
354	MICROMETER	S99
355	MICROPIPETTES	44
356	MICROPLATE SHAKER	66
357	MICROPROCESSOR BASED D.O METER	100
358	MICROPROCESSOR BASED WATER&SOIL ANALYSIS KIT	100
359	MICROSCOPE	101
360	MICROSCOPE BINOCULAR	114
361	MICROTIP BOXES	89
362	MICROTIPS (FILTER TIPS)	90
363	MICROTIPS (PIPETTE TIPS)	90
364	MINI DRAFTER EXPORT QUALITY	97
365	MIXING VAT WITH STIRRER	114
366	MONSANTO TYPE TABLET HARDNESS TESTER	114
367	MORTAR MIXER FOR BITUMEN TEST	104
368	MORTARS AND PESTLES	111
369	MOSQUITO ARTERY FORCEPS	114
370	MOTORIZED SIEVE SHAKER	103
371	MULTI CAVITY SEED DISPLAYER	31
372	MULTI USE RACK	33
373	MULTIWELL SEALING PADS	46
374	MUSLIN CLOTH BAG-SCINATION	126
375	MUSLIN CLOTH-SCINATION	125
376	NAGA/ CAMMO/ ON 21/ PARA PATTERN	99
377	NEEDLE DESTROYER	114

PRISTINE BIOMEDICAL THE BRAND APART, THE STRAND APART		
SL. NO	DESCRIPTION	PAGE NO
378	NEEDLE HOLDER	114
379	NEEDLES, STERILIZED	117
380	NEPHELOMETER	100
381	NESSLERS CYLINDER	107
382	NYLON NET BAG	123
383	NYLON NET FOR BIRD PROTECTION	122
384	NYLON NET SELFING BAG-SCINATION	125
385	OINTMENT SLAB	114
386	OINTMENT SPATULAS	124
387	OPERATION TABLE	114
388	OPTICA CELLS (CUVETTES)	80
389	ORBITAL SHAKER	67
390	ORBITAL SHAKER	67
391	OUTLET FORCEP	115
392	OXYGEN CYLINDER	115
393	OXYGEN FLOW METER	115
394	OXYGEN KIT WITH MASK	93
395	PARAFILM DISPENSER	17
396	PARAFILM M	16
397	PARAFIN COATED (WAX) PAPER	78
398	PARALLEX BAR (STEREO METER)	97
399	PARTICULATE RESPIRATOR	10
400	PASSIVE AVOIDANCE RESPONSE TEST APP.	115
401	PASTEUR PIPETTES	60
402	PCR PLATES	30
403	PCR RACK WITH COVER	32
404	PCR TUBES	30
405	PCR WORKERBENCH RACK	32
406	PEDIATRIC SUCTION MACHINE ELECTRIC	115
407	PENSKEY MARTIN FLASH & FIRE	104
408	PESTLE	58
409	PETRI DISH	28
410	PETRI DISH	107
411	PETRI DISHES	111
412	PETRI SEAL	4
413	PH/TEMP./MV METER	100
414	PHOTO COLORIMETER&FILTERS	100

PRISTINE BIOMEDICAL THE BRAND APART, THE STRAND APART		
SL. NO	DESCRIPTION	PAGE NO
	PIPETTE CAROSEAL	
415	(EPPENDORF PIPETTE HOLDER STAND)	118
416	PIPETTE FILTER	59
417	PIPETTE GRADUATED	107
418	PIPETTE GRADUATED (MOHR TYPE)	111
419	PIPETTE VOLUMETRIC	108
420	PIPETTE VOLUMETRIC ONE MARK (BULB TYPE)	111
421	PLANT GROWTH REGULATOR	60
422	PLANT IDENTIFICATION PEGS	31
	PLANT TAG WITH THREAD (TAG LABLE / PRICE LABLE)-SCINATION	
423		126
424	PLANTATION POTS	43
425	PLASTIC ARROW TYPE TREE LABEL	124
426	PLASTIC BAG WITH LAMINATION	122
427	PLASTIC LIMIT DEVICE	104
428	PLASTIC RING FOR MUSHROOM-SCINATION	124
429	PLASTIC SHEET MULCHING	123
430	PLASTIC WHITE FLY YELLOW TRAP	123
431	PLATE & PRISM HOLDER	95
432	PNEUMETIC TROUGH	111
433	PNUEATHORAX BOTTLES (A.P BOTTLE)	111
434	POLE CLIMBING APPARATUS	115
435	POLISHING PAN	115
436	POND LINING	124
437	POSTMORTUM GLOVES(PAIR)	115
438	POSTMORTUM SET	115
439	POUNCHOOS	99
440	POWER GUARD	97
441	POWER SUPPLIES	73
442	PPE KIT (PERSONAL PROTECTIVE EQUIPMENT)	89
443	PRISMATIC COMPASS	96
444	PRISTINE LATEX EXAM GLOVES	53
445	PRISTINE LITE NITRILE GLOVES	53
446	PROCTOR MOULD AND RAMMER	103

PRISTINE BIOMEDICAL THE BRAND APART, THE STRAND APART		
SL. NO	DESCRIPTION	PAGE NO
447	PRODUCTS FOR LIFE SCIENCE - FROM EXTRACTION TO THE DETECTION	127
448	PTFE BEAKER	22
449	PUNCHING MACHINE	115
450	PYCNOMETER BOTTLE	103
451	R.D. BOTTLE WITH GLASS STOPPER	105
452	RACK FOR 15ML/ 50ML CENTRIFUGE TUBE	35
453	RACK FOR 50ML TUBE	35
454	RACK FOR MICRO CENTRIFUGE TUBES	36
455	RAIN GAUGE CYLINDERS GRADUATED	112
456	RAIN GAUGE RECORDING WITH MEASURING JAR	97
457	RAMMER FOR CORE CUTTER	103
458	RAPID DIAGNOSIS - EASY TO USE FOR SCREENING	127
459	RAPID MOISTURE METER (SOIL MOISTURE METER)	99
460	RAPID MOISTURE METER PACKED IN WOODEN BOX	104
461	REAGENT BOTTLE	112
462	REAGENT BOTTLE (NARROW MOUTH)	23
463	REAGENT BOTTLE (WIDE MOUTH)	24
464	REAGENT BOTTLE N. M, AMBER COLOR	106
465	REAGENT BOTTLE NARROW MOUTH	108
466	REAGENT BOTTLE W. M. SCREW CAP	108
467	REAGENT BOTTLE WIDE MOUTH	108
468	REAGENT BOTTLES GLASS	24
469	REAGENT FOR MOISTURE METER (CARBIDE CHEMICAL)	104
470	REAGENT RESERVOIR	21
471	REDWOOD VISCOMETER	104
472	REFLUXE ASSEMBLY	106
473	RESEALABLE BAGS WITH ZIP LOCK	9
474	RESERVOIRS FOR ROBOTIC SYSTEMS	118

PRISTINE BIOMEDICAL THE BRAND APART, THE STRAND APART		
SL. NO	DESCRIPTION	PAGE NO
475	REVERSIBLE RACK	36
476	RHIOCERA, PLAIN	117
477	RHIZON IRRIGATOR	117
478	RHIZON SAMPLERS	117
479	RNA DEGRADATION SOLUTION	85
480	RNA STABLE	119
481	ROTA ROAD II -V CAMP	115
482	ROTARY LASER ML-101 SERIES	95
483	ROUND BOTTOM FLASK	106
484	ROUND BOTTOM FLASK JOINT B 24/29,	106
485	ROUND BOTTOM FLASK, THREE NECK	106
486	ROUND BOTTOM FLASK, TWO NECK	106
487	RT BOTTLES	111
488	RUCK SACK	99
489	SAFESKIN PURPLE NITRILE GLOVES	54
490	SAFETY FACE SHIELD	10
491	SAFETY GOGGLES	9
492	SAFETY GOGGLES BOX	9
493	SAFETY TOUCH KEY	92
494	SAINT GOBIN BENCH PROTECTOR	6
495	SAINT GOBIN CHEMWARE BOILING STONES	7
496	SALINITY METER	100
497	SAMPLE BAGS	19
498	SAND REPLACEMENT APPARATUS	104
499	SAND REPLACEMENT METHOD (IN MM)	98
500	SAY VOLT VISCOMETER	104
501	SEALING FILM / MAT ROLLER	31
502	SEALING FILM FOR CELL CULTURE PLATES	45
503	SEALING FILM FOR COLD STORAGE	45
504	SEALING FILM PIEARACBLE	44
505	SEED PACKET TAG / HARVESTING TAG	124
506	SEPARATING FUNNEL PTFE ROTA FLOW STOP COCK	106

PRISTINE BIOMEDICAL THE BRAND APART, THE STRAND APART			PRISTINE BIOMEDICAL THE BRAND APART, THE STRAND APART		
SL. NO	DESCRIPTION	PAGE NO	SL. NO	DESCRIPTION	PAGE NO
507	SEROLOGICAL PIPETTES	59	540	SPONGE HOLDING FORCEP	115
508	SEROLOGICAL PLATE	38	541	STAINLESS STEEL FREEZER RACKS	20
509	SERUM SAMPLE CRYOGENIC VIALS	58	542	STANDARD PENETROMETER	103
510	SHEET HOLDER (KEEPING THE DRAWING SHEET)	97	543	STERO SCOPE	97
511	SHOCK BOX	115	544	STETHOSCOPE	115
512	SHOES: DMSF/ DMSL/ PARA PATTERN	99	545	STITCH CUTTING SCISSOR	115
513	SHRINKAGE LIMIT	104	546	STOMACH WASH TUBE	115
514	SIEVES	103	547	STORAGE VIALS	58
515	SILWET / VAC-IN-STUFF	61	548	STRECHER FOLDING MADE OF CANVAS	115
516	SIMPLE LEVER	115	549	STRECHER WITH TROLLY	115
517	SINGLE UNIT ORANGE BATH	115	550	SUCTION APPARATUS	115
518	SLEEPING BAG)	99	551	SUCTION CANNULA	115
519	SLUMP TEST APPARATUS COMPLETE	98	552	SUNSHINE BALL	96
520	SLUMP TEST APPARATUS COMPLETE SET	103	553	SUNSHINE RECORDER COMPLETE WITH CHART	96
521	SMARTCOAT DECONTAMINANTS	84	554	SURGICAL ITEMS	113
522	SMOKING BURNER	115	555	SURGICAL TRAY WITH COVER	115
523	SMOKING BURNER -KEROSENE	115	556	SURVEY COMPASS	96
524	SODA LIME GLASSEWARE	108	557	SURVEYING & MAPPING SOFTWARE	94
525	SOFTENING POINT TEST APPARATUS	103	558	SWIMMING TEST APPARATUS	115
526	SOIL PERMEABILITY TEST APPARATUS COMPLETE SET	103	559	SYRINGE FILTERS	49
527	SOIL PH METER	31	560	SYRINGE SET 5 ML AND RETAINER	117
528	SOLUTION BOTTLES	25	561	SYRINGESET 10 ML	117
529	SORGHUM POLLINATING BAG-SCINATION	124	562	T.L.C. KIT	115
530	SOUND LEVEL	97	563	TABLET COUNTER	115
531	SOXLETTE EXTRACTION APPARATUS	106	564	TABLET HARDNESS TESTER PFIZER TYPE	115
532	SPARE THISTLE FUNNEL & FITTING ONLY	111	565	TAIL FLICK APPARATUS	115
533	SPECIFIC GRAVITY APPARATUS (BUOYANCY BALANCE)	103	566	TAR VISCOMETER COMPLETE SET	103
534	SPECIMEN JARS	112	567	TARPAULIN ASSORTED SIZE-SCINATION	126
535	SPECIMEN TUBE	112	568	TASSEL BAG-SCINATION	124
536	SPECIMEN TUBES	58	569	TEETH FORCEP	115
537	SPECTROPHOTOMETER	100	570	TELE THERMOMETER	115
538	SPILFYTER LAB SOAKER	6	571	TELE THERMOMETER WITH VETERINARY PROBS	100
539	SPIRIT LAMP	112		TELESCOPIC SPECIAL STAND FOR TOTAL STAND & ELECTRONIC THEODOLITE	96

PRISTINE BIOMEDICAL THE BRAND APART, THE STRAND APART			PRISTINE BIOMEDICAL THE BRAND APART, THE STRAND APART		
SL. NO	DESCRIPTION	PAGE NO	SL. NO	DESCRIPTION	PAGE NO
573	TEMPRATURE RESISTANT GLOVES	10	603	VACCUM FILTERATION APPARATUS	60
574	TENT "ARCTIC" NYLON WITH POLE & HANGER	99	604	VACUUM FILTRATION APPARATUS-GLASS	28
575	TEST SIEVE 8'BRASS	116	605	VACUUM TUBES, NO ADDITIVES	117
576	TEST SIEVES	82	606	VAGINAL RETRACTOR	115
577	TEST TUBE BOROSILICATE GLASS	108	607	VAGINAL SOEACULAM	115
578	TEST TUBE GRADUATED	108	608	VANE SHEAR APPARATUS	103
579	TEST TUBE PIGEONHOLE PACK	108	609	VEE BEE CONSISTOMETER - MOTORISED	104
580	TEST TUBE STAND	37	610	VERNIER CALIPERS	99
581	TEST TUBE STOPPER WITH JOINT	108	611	VIBRATING MACHINE GOOD QUALITY	104
582	THERMO CONDUCTIVE RACK	86	612	VIBRATING TABLE	103
583	THISTLE FUNNEL	108	613	VICAT NEEDLE APPARATUS	103
584	THREE LAYERED ALUMINIUM FOIL POUCH PLAIN	121	614	VICTOR MEYERS APPARATUS	108
585	THRESHING SHEET DASUTI CLOTH-SCINATION	126	615	VINYL GLOVES	53
586	THUMB FORCEP	115	616	VISCOMETER	101
587	TILE ABRASION TESTING MACHINE COMPLETE	104	617	VISCOMETER	108
588	TINCHER PRESS	115	618	VOLUMETRIC FLASK CLASS A	23
589	TISSU HOMOZENISER	115	619	VOLUMETRIC FLASK SOLID STOPPER	108
590	TISSUE CULTURE JAM BOTTLE	43	620	VULSELLUM FORCEPS	115
591	TRIAxIAL TESTING MACHINE COMPLETE WITH ALL STANDARD	104	621	WASH BOTTLE	26
592	TUBE FILLING	115	622	WATERPROOF ENVELOPES- SCINATION	125
593	TURBIDITY METER	100	623	WEIGHING BOTTLE SQUAT FORM	108
594	U.V. CABINET SMALL	115	624	WEIGHING BOTTLE TALL FORM	108
595	U.V. STABILIZED RIGIDEX FILM	123	625	WEIGHT MACHINE	115
596	UNCONFINED COMPRESSION TESTING MACHINE	104	626	WINCHESTER BOTTLE	108
597	UNIVERSAL RACK	37	627	WIRE RACK	35
598	UNIVERSAL TESTING MACHINE (UTM)	102	628	WOOD MOISTURE METER (DIGITAL)	99
599	URIN PORT FEMALE/MALE	115	629	WOODEN RETAINER	117
600	URINE TEST GLASS GRADUATED	111	630	WORKSPACE STORAGE BINS	17
601	UV STABILIZED POLYTHENE SHEET	122	631	WOULF BOTTLES	109
602	UV_VIS SPECTROPHOTOMETER DOUBLE BEAM	100	632	X-TRACTA GEL EXTRACTION TOOL	77
			633	YELLOW METAL FOLD SEED PACKET-SCINATION	125

TABLE OF CONTENTS

(SEQUENTIAL ARRANGEMENT OF TITLES AS PER THEIR PAGE NUMBER)

PRISTINE BIOMEDICAL <i>THE BRAND APART, THE STRAND APART</i>		
SL NO	DESCRIPTION	PAGE NO
634	INTRON BIOTECHNOLOGY: MOLECULAR DIAGNOSIS - HIGH SPECIFICITY & SENSITIVITY	127
635	RAPID DIAGNOSIS - EASY TO USE FOR SCREENING	127
636	PRODUCTS FOR LIFE SCIENCE - FROM EXTRACTION TO THE DETECTION	127
637	INTRON BIOTECHNOLOGY: PREMADE BUFFER	133
638	INTRON BIOTECHNOLOGY: VIRUS & BACTERIA	138
639	CLINICAL CHEMISTRY: BIOCHEMISTRY / DIAGNOSTICS REAGENTS / KITS	143
640	ELISA KITS / RIA KITS	143
641	PLANT ANTIBODIES / DETECTION REAGENTS	162
642	LABORATORY REAGENTS, FINE CHEMICALS & FILTER PAPERS	197
643	MOLECULAR BIOLOGY/IMMUNOLOGY/TISSUE CULTURE WARE/LABWARE	262
644	CUSTOM DNA SYNTHESIS (DESALTED DNA OLIGOS)	264
645	SEQUENCING SERVICES	264
646	FILTER PAPERS	265
647	MOLECULAR BIOLOGY KITS, REAGENTS SCIBIO-PRISTINE	266
648	CUSTOM SERVICES	273
649	NEXT GENERATION SEQUENCING	273
650	LONG READ SEQUENCING	286
651	SANGER SEQUENCING SERVICES	287
652	MICROARRAY AND GENOTYPING	288
653	PROTEOMICS & ANALYTICAL SERVICES	288
654	CUSTOM OLIGO SYNTHESIS	289
655	MOLECULAR BIOLOGY KITS	289
656	SAMPLE PREREQUISITE	289
657	ASSAY KITS FOR FOOD, FEED, DAIRY, WINE, BEVERAGE, CEREALS, FERMENTATION AND BIOFUEL	290
658	LIQUID HANDLING, CYTOGENETICS, ROBOTICS	305